

projects  
book

/01



# CONTARDI PROJECTS BOOK

## Vol.1

---

Contardi ha deciso di lasciare la parola alle immagini, mostrandovi alcune delle sue realizzazioni.

Storie di tradizione ma anche di contemporaneità dove i prodotti Contardi esprimono la visione del designer.

Projects Book Vol. 1 nasce dalla capacità di cogliere e tradurre il pensiero del progettista, nel rispetto delle esigenze del cliente e del budget del progetto.

Hotel, ristoranti, residenze, yachts diventano palcoscenici dove la versatilità dei prodotti si integra alla perfezione, indipendentemente dallo stile e dalle caratteristiche del progetto stesso.

**Servizio, flessibilità e qualità: questa è Contardi. Lasciatevi ispirare. Buona visione.**

"Noi non siamo veri e propri romanzi.  
Noi non siamo veri e propri racconti.  
Noi siamo opere complete"

(Gabrielle Zevin)

*Contardi has decided to let the images speak and show some of its installations.*

*Stories of tradition but also of modernity where Contardi's products express the designer's vision.*

*Projects Book Vol. 1 comes from the ability to catch and translate the designer's concept, meeting client's needs and the budget of the project.*

*Hotels, restaurants, residences and yachts become stages where the versatility of the products blends perfectly, independently from the style and characteristics of the project itself.*

***Service, flexibility and quality: this is Contardi. Let yourself be inspired. Enjoy the show.***

*"We are not quite novels.  
We are not quite short stories.  
We are collected works."*

*(Gabrielle Zevin)*

# INDEX

## CONTARDI DIVISIONS / DIVISIONI CONTARDI

04

- Home Division / *Divisione Casa* 6
- Contract Division / *Divisione Contract* 7

## HOSPITALITY / HOTEL

08

- Lutetia Hotel - Paris (FR) | **Case study: custom-made** 11
- Park Hyatt - Washington DC (USA) 19
- Grand Hotel Kempinski - Geneve (CH) 23
- Palm Suite - Rome (IT) 29
- Mandarin Oriental - Miami (USA) 33
- Palazzo Manfredi - Rome (IT) 37
- Severin\*s Alpine Retrait - Lech (AT) 41
- Excelsior Hotel - Pesaro (IT) 45
- Turin Palace - Turin (IT) | **Case study: value engineered** 51
- Atlantis Hotel by Giardino - Zurich (CH) 53

## RESTAURANTS / RISTORANTI

56

- Novikov Restaurant - Miami (USA) 59
- Elimar Beach bar & Restaurant - Venice (IT) | **Case study: modified stock** 61
- Malaspina Restaurant - Parma (IT) 65
- 59 Restaurant - Pesaro (IT) 69
- Pix Pintxos - London (UK) 71
- Les Petites Madeleines - Turin (IT) 73
- The Nordic Grill - Milan (IT) 75
- Dabass Bar & Restaurant - Milan (IT) 77
- Les Loges Bar & Restaurant - Montpellier (FR) 79

## RESIDENTIAL / RESIDENZE PRIVATE

80

- Villa Oiseau Bleu - Cote D'azur (FR) | **Case study: contardi collection** 83
- Walnut Apartment (Buxmead) - London (UK) 91
- Riverstone residential complex - Kiev (UA) 103
- Notary House - Tilburg (NL) 109
- L'Elegance - Cote D'azur (FR) 113
- Okyrhoe Villa - Mykonos (GR) 117
- Family House - Tilburg (NL) 121
- Holidays Villa - Algarve (PT) 125
- Parkside - Hong Kong (CN) 129

## YACHTS / YACHT

140

- M/Y Polar Star Superyacht 133
- Azimut Yacht 77S 137
- Azimut Yacht AZ50 139
- Lady Soul yacht 141
- M/Y Silver Fast yacht 143

## THANKS TO / RINGRAZIAMENTI

144

- Thanks to... 144



# CONTARDI

- HOME DIVISION / *Divisione Casa*
- CONTRACT DIVISION / *Divisione Contract*

## HOME DIVISION

*Divisione Casa*



### STANDARD COLLECTION

**Non si può davvero illuminare con lampade decorative?  
Per Contardi deve diventare possibile!**

Oggi, l'obiettivo è quello di creare prodotti che siano allo stesso tempo **decorativi** ma anche **funzionali**.

La collezione Contardi è composta da **oltre 100 modelli** realizzati con materiali differenti: dal metallo al vetro, dal tessuto al marmo, così come ceramica e legno.

*Is it true that decorative lights do not illuminate?  
Not for Contardi!*

*Our aim today is to create products, which are **decorative** and **functional** at the same time.*

*Contardi's collection is composed by **over 100 models** made of different materials: from metal to glass, from fabrics to marble, as well as ceramics or wood.*

## CONTRACT DIVISION

*Divisione Contract*



### MODIFIED STOCK

Versioni dei prodotti Contardi riadattati per venire incontro alle esigenze del designer e del cliente, senza cambiamenti strutturali.

*Versions of Contardi collection products adapted to meet the requirements of designers and clients without structural changes.*



### "VALUE ENGINEERED"

Versioni dei prodotti Contardi rielaborate ed ingegnerizzate in base alle esigenze del progetto e al budget del cliente.

*Value engineered versions of Contardi products according to the project's requirement and client's budget.*



### BESPOKE PRODUCTS

Prodotti su misura realizzati partendo dall'idea e dal design del professionista, senza limiti di stile e di materiali.

*Custom-made, based on the professional's design and concept. No limitation in style and materials.*



# HOSPITALITY

- LUTETIA HOTEL - PARIS (FR)
- PARK HYATT - WASHINGTON DC (USA)
- GRAND HOTEL KEMPINSKI - GENEVE (CH)
- PALM SUITES - ROME (IT)
- MANDARIN ORIENTAL - MIAMI (USA)
- PALAZZO MANFREDI - ROME (IT)
- SEVERIN'S ALPINE RETREAT - LECH (AT)
- EXCELSIOR HOTEL - PESARO (IT)
- TURIN PALACE - TURIN (IT)
- ATLANTIS HOTEL BY GIARDINO - ZURICH (CH)



## CASE STUDY: CUSTOM-MADE

### Lutetia Hotel - Paris (FR)

---

La Divisione Contract di Contardi ha fornito l'illuminazione per la ristrutturazione dell'hotel a 5 stelle Lutetia a Parigi, un'icona di riferimento situato nella vivace zona di Saint-Germain-des-Prés sulla famosa "Rive Gauche". Gli apparecchi di illuminazione di tutte le camere e le suite sono stati realizzati su misura su progetto di **Wilmotte & Associés Architects**, con il desiderio di far rivivere lo spirito del progetto originale del 1910, migliorando e ottimizzando le funzioni dell'hotel.

Il risultato è una combinazione di materiali preziosi come ottone, marmo e vetro artistico, combinati all'utilizzo della più recente tecnologia LED e dei sistemi di controllo digitale.

Contardi è orgogliosa di essere stata selezionata per un progetto così prestigioso.

*Contardi Contract Division has supplied the lighting for the renovation of the 5\* Lutetia Hotel in Paris, an iconic landmark situated in the vibrant Saint-Germain-des-Prés area, on the renowned "Rive Gauche".*

*The custom lighting fixtures have been designed by **Wilmotte & Associés Architects** for all the rooms and suites, with the wish to revive the spirit of the original 1910 project, while improving and optimising the functions of the hotel.*

*The result is a combination of precious materials such as brass, marble and artistic glass, along with the use of the latest LED technology and digital control systems.*

*Contardi is proud of having been selected for such a prestigious project.*



Lampada a sospensione con diffusore in policarbonato opalino serigrafato e faretti orientabili con apertura angolare (20° - 45°). Dimmerabile (DALI).

*Pendant lamp with opal moulded polycarbonate diffuser and adjustable spotlights with angle opening (20° - 45°). Dimmable (DALI).*

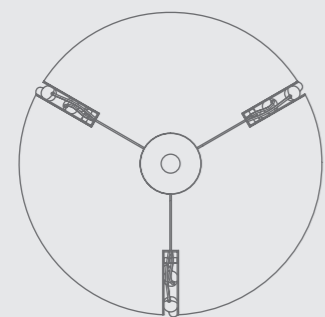

Vista dall'alto / Top view

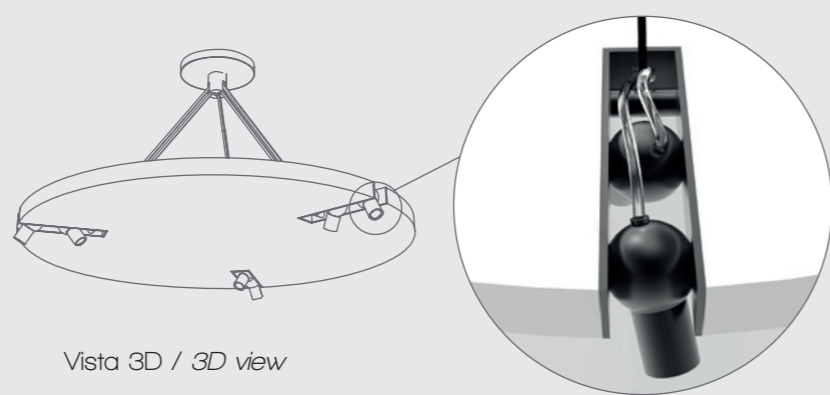

Vista 3D / 3D view

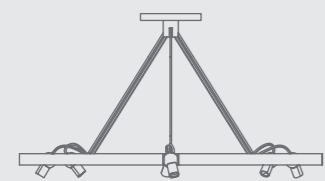

Vista frontale / Front view

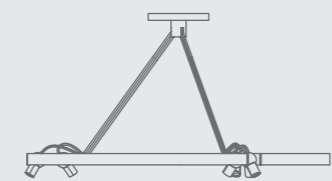

Vista laterale / Left side view

Faretti / spotlights:  
6 x 5 W , tot. 1800 lm  
2700 K , CRI: 90



Stampo per termoformatura.  
Mold for thermoforming.



Piastra LED custom / Custom LED board:  
160 W , 18400 lm  
2700 K , CRI: 90



Diffusore olicarbonato opaco serigrafato.  
Printed opal polycarbonate diffuser.





Applique lato letto realizzata con diffusori tonde in vetro di Murano soffiato effetto marmorizzato bianco. Dimmerabile (DALI).

*Bedroom wall sconce with round Murano blown glass diffusers, white marbled effect. Dimmable (DALI).*

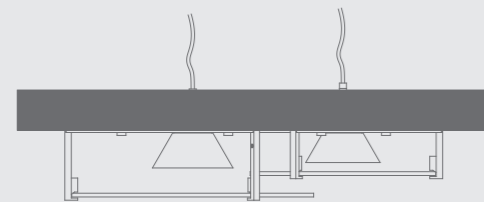

Vista dall'alto / Top view

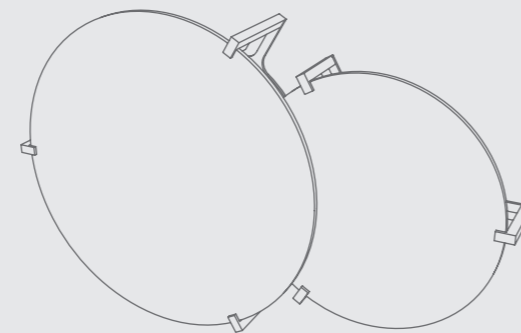

Vista 3D / 3D view

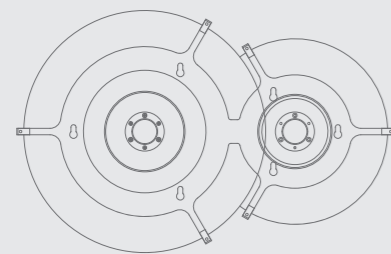

Vista frontale / Front view

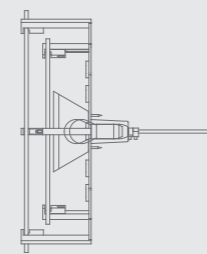

Vista laterale / Left side view

Lampadine LED filamento /  
LED filament bulbs:  
2 x 4 W E14 , tot. 640 lm  
2700 K , CRI: 90



Lampada da terra (versione singola e trio) con struttura bronzo spazzolato e diffusori in vetro lenticolare.

*Floor lamp (single and trio version) with satin bronze frame and lenticular glass diffusers.*

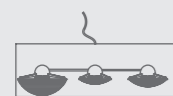

Vista dall'alto / Top view

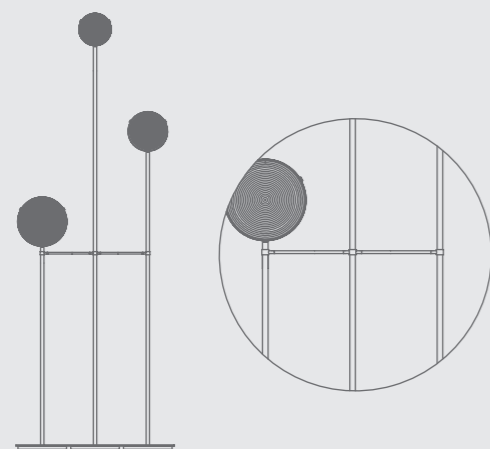

Vista frontale / Front view



Vista laterale / Left side view

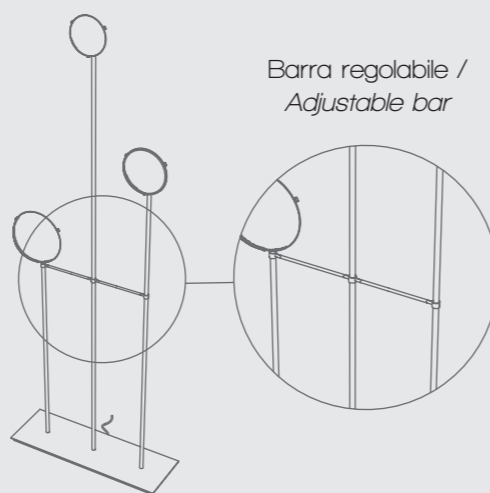

Barra regolabile / Adjustable bar

Vista 3D / 3D view

3 x 5 W Custom LED  
tot. 1350 lm  
2800 K , CRI: 90



## PARK HYATT - WASHINGTON DC (USA)

Nel 2016 il Park Hyatt di Washington DC ha riaperto i battenti dopo una cospicua ristrutturazione seguita dal celebre designer **Tony Chi**. Modernismo dinamico e classico stile americano sono alla base del concept del progetto. Contardi ha rifornito le 216 stanze con lampade custom e di collezione.

*In 2016, Park Hyatt Washington DC reopened its doors after a remarkable renovation and redesign by the renowned designer **Tony Chi**. Dynamic modernism and classic American style are the main concept behind this project. Contardi supplied the 216 rooms with custom and standard lamps.*



Applique da bagno con paralume in tessuto impermeabile e grado di protezione IP44.  
*Bathroom wall sconce with waterproof fabric shade and IP44 rate.*

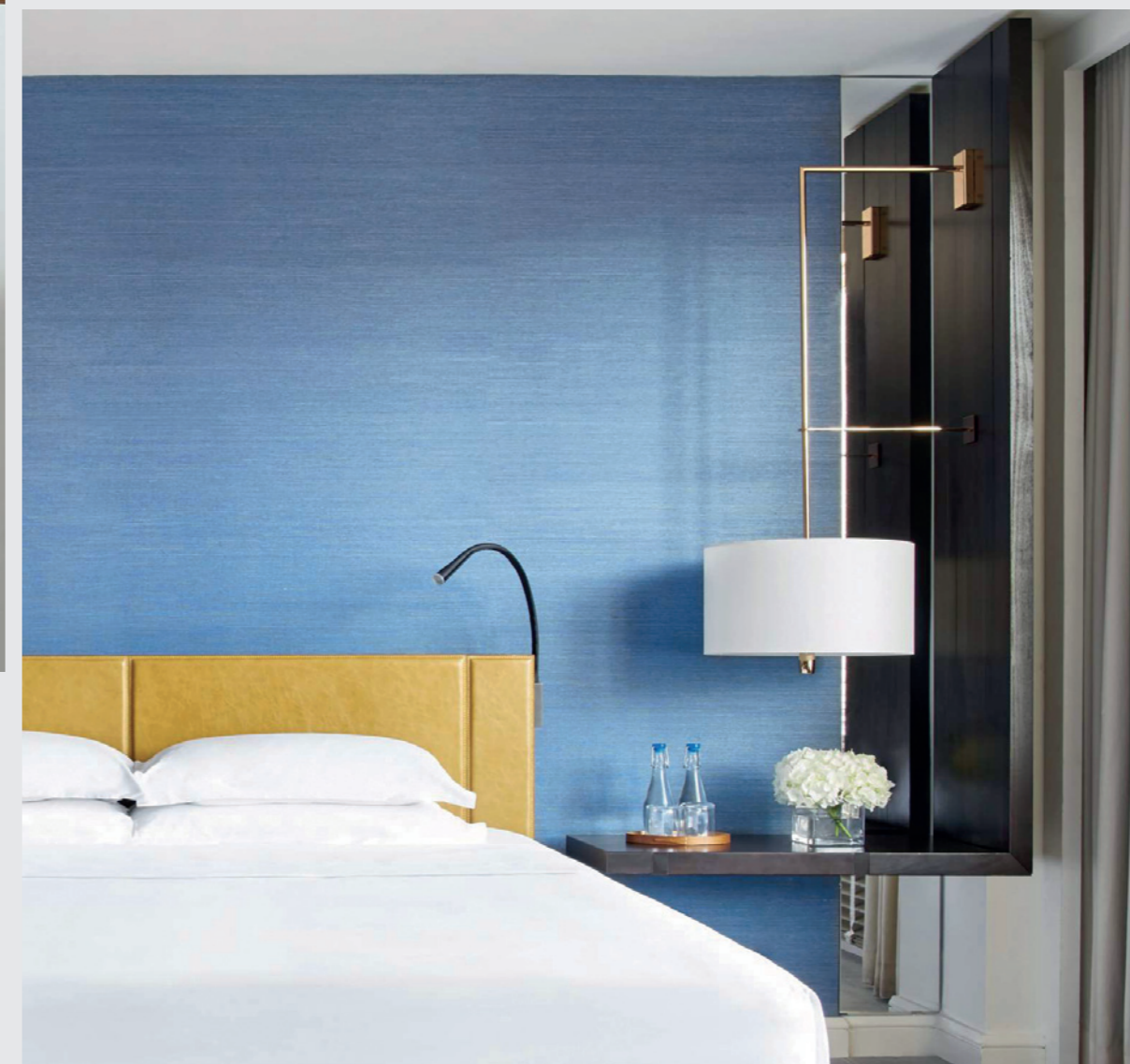

STD

Flexiled AP: pelle nera e  
basetta nickel satinato.

*Flexiled AP: black leather  
and satin nickel base.*

CST

Lampada da comodino con struttura in  
finitura rame e paralume in cotone bianco.

*Bedside lamp in copper finish body and  
white cotton shade.*



## GRAND HOTEL KEMPINSKI - GENEVE (CH)

Cosa ha ispirato lo stile degli interni? L'hotel ha deciso di rinnovare le stanze per stare al passo con la concorrenza e portare un nuovo e fresco approccio al design. Lo studio **Living Design** è stato selezionato per rinnovare il concept iniziale e ricreare una stanza confortevole ed accogliente, dove i dettagli siano ben curati ed eseguiti, oltre a prestare attenzione alle nuove tendenze del design e al comfort dell'ospite. Per questo progetto sono state selezionate tre lampade della collezione standard (Flexiled AP, Coco AP, Kira TA) e tre lampade su misura: una lampada da comodino, una lampada da lettura e una lampada da terra. L'obiettivo è stato raggiunto grazie alle nuove finiture proposte e ad un mix di materiali.

*What's inspired the style of the rooms? The hotel has decided to renovate the rooms in order to keep up with the competitors and to bring a fresh approach to their design. **Living Design** was selected to renovate the original design concept and to recreate a cosy room where details are well finished and executed, with particular attention to the new design trends and to the comfort of the guest. Many lamps from Contardi standard collection (Flexiled AP, Coco AP, Kira TA) and three custom-made lighting fixtures have been selected for the rooms: the bedside table lamp, the desk lamp to the floor lamp. Aim achieved thanks to the new finishes and material mix.*



Flexiled AP: pelle nera e bassetta bronzo spazzolato.  
*Flexiled AP: black leather and satin bronze base.*



Lampada a sospensione per comodino con diffusore acrilico e rosone laccato bronzo.  
*Bedside pendant lamp with acrylic diffuser and lacquered bronze canopy.*



Lampada da tavolo e applique con struttura in mogano e inserti in bronzo spazzolato. Paralume in percaline bianco e interno argento.

*Table lamp and wall sconce with mahogany wood body and satin bronze inserts. White percaline shade with silver lining.*



Kira TA





Lampada da terra con stelo in mogano con inserti in bronzo spazzolato.  
Pardume in percaline bianco con interno argento.

*Floor lamp with mahogany wood body and satin bronze inserts.  
White percaline shade with silver lining.*





## PALM SUITES - ROME (IT)

In un edificio del '700 a Roma trasformato recentemente in residenze turistiche di lusso, ai piedi dei giardini dei Fori Imperiali, con affacci sulla Basilica di Massenzio e sul Colosseo, Giorgia Dennerlein dello studio di architettura **Loto Ad Project**, firma gli interni delle suites.

*Leitmotiv* del progetto: la palma.

Per gli interni sono stati privilegiati tessuti naturali, colori e motivi esotici per enfatizzare la connessione tra l'interno e le viste esterne dei giardini dei Fori. Protagonista indiscussa è la lampada Calypso di Contardi, disegnata da Servomuto, che offre un'inaspettata combinazione di patterns e colori vivaci ed una luce diffusa. Contardi contribuisce al progetto anche con le lampade Audrey e Up, disegnate dallo studio Massimiliano Raggi.

*In an 18th century building in Rome recently turned into luxury tourist residences, next to the Fori Imperiali gardens, in front of Basilica di Massenzio and Colosseum, Giorgia Dennerlein of **Loto Ad Project** studio, designs the suites interiors.*

*Leitmotiv of the project: the palm.*

*For the interiors, natural fabrics, colours and exotic patterns have been chosen to emphasise the connection between the interior and the external views of the Fori Imperiali gardens. The undisputed protagonist is Calypso lamp by Contardi, designed by Servomuto, which offers an unexpected combination of patterns and colours with brightly diffused light. Contardi puts its signature to the project also with Audrey and Up lamps, designed by Massimiliano Raggi studio.*



Calypso SO: versione con paralume ANTIGUA nella finitura "Mint".

*Calypso SO: ANTIGUA shade in "Mint" finish.*





Audrey FL: paralume in cotone e velluto avorio e passamaneria in seta nera.

*Audrey FL: ivory cotton and velvet shade with black silky trim.*



Up FL: struttura bronzo spazzolato con dettagli in ottone. Stelo in corda in seta intrecciata color miele.

*Up FL: satin bronze body with satin brass details. Stem covered by braided silky cord, honey colour.*



## MANDARIN ORIENTAL - MIAMI (USA)

Circondato da splendide viste sull'acqua e sulla città, il Mandarin Oriental di Miami porta l'essenza del lusso a cinque stelle a Brickell Key. Le stanze dal gusto asiatico e dai toni vivaci sono illuminate da alcuni classici della collezione Contardi come le Flexiled Ap e le Quadra Liseuse per la zona letto, le Divina FL Arco e le Kira Ta nelle suite. Il progetto è stato seguito dallo studio CCI Design.

*Surrounded by stunning water and city views, the Mandarin Oriental in Miami brings the essence of five-star luxury to Brickell Key.*

*The rooms, characterised by a taste of Asia and bright colours, are lighted up by some classics from Contardi collection as Flexiled AP and Quadra Liseuse in the bed area, Divina FL Arco and Kira TA for the suites. Project by CCI Design studio.*



Flexiled AP: versione in pelle marrone testa di moro e basetta bronzo spazzolato, con piastra di fissaggio USA.

*Flexiled AP: dark brown leather and satin bronze version with US backplate.*



Divina FL Arco: struttura laccata bronzo e paralume plissettato in cotone bianco.

*Divina FL Arco: bronze lacquered body and white cotton pleated shade.*



Quadra Liseuse: struttura bronzo spazzolato e paralume in cotone bianco.

*Quadra Liseuse: satin bronze body and white cotton shade.*



## PALAZZO MANFREDI - ROME (IT)

---

Palazzo Manfredi è un elegante edificio del XVII secolo con viste straordinarie sul Colosseo, i Fori Imperiali e la Domus Aurea. È arredato con quadri del 500 ed opere d'arte combinate ad arredi moderni e contemporanei. Per illuminare le suites Ludus Magnus, **Loto AD Project** si affida a Contardi e seleziona alcuni prodotti della collezione standard: Flexiled FL e Bach AP per la stanza da letto, Cube e Frame TA per il salotto.

*Palazzo Manfredi is an elegant seventeenth-century building with extraordinary views on Colosseum, Fori Imperiali and Domus Aurea. It is decorated with paintings of the 16th century and art pieces combined with modern and contemporary furniture. **Loto AD Project** has chosen Contardi to illuminate the Ludus Magnus suites, selecting several products from the standard collection: Flexiled FL and Bach AP for the bedrooms, Cube and Frame TA for the living rooms.*



Bach AP: versione cromo con diffusori in plexiglass satinato.  
*Bach AP: chrome body and satin plexiglass diffusers.*



Flexiled FL: versione pelle nera e nickel satinato.  
*Flexiled FL: black leather and satin nickel version.*

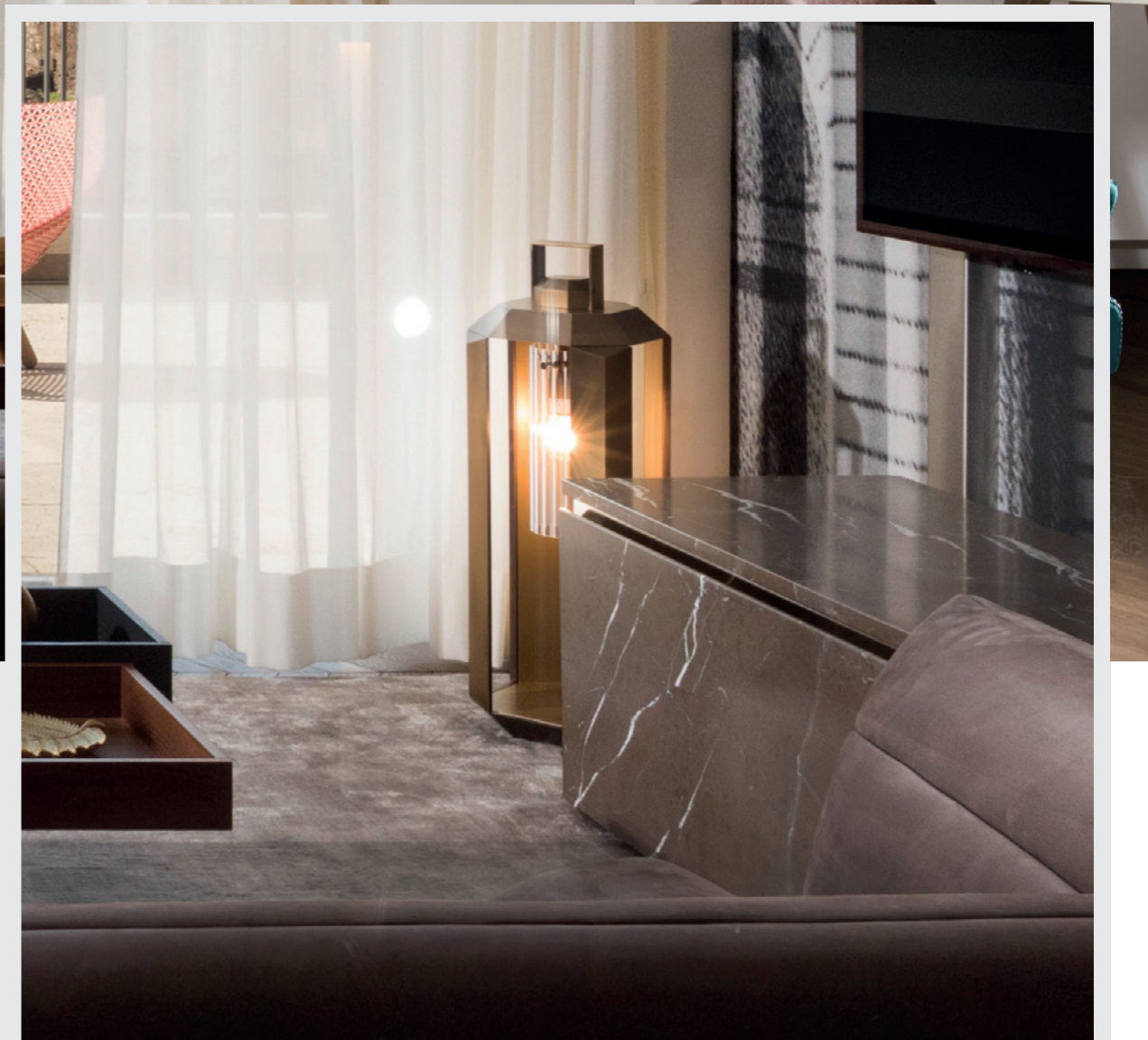

Cube TA small: struttura esterna bronzata e struttura interna in metallo laccato oro. Diffusore in vetro pyrex rigato.

*Cube TA small: bronzed external frame. Gold painted metal internal lining. Striped pyrex glass diffuser.*



Frame TA: struttura rovere scuro e base nickel lucido. Paralume in cotone bianco.

*Frame TA: dark oak body and polished nickel base. White cotton shade.*



## SEVERIN\*S THE ALPINE RETREAT - LECH (AT)

Inaugurato ufficialmente nel 2016 a Stubenbach (Lech), l'hotel a 5 stelle SEVERIN\*S - The Alpine Retreat offre ai suoi ospiti un'esperienza di lusso, qualità e comfort eccezionale.

In perfetta armonia con l'ambiente circostante, grazie alla facciata in pietra e alla struttura in antico legno tirolese proveniente dalle foreste locali, il Serevin\*s - The Alpine Retreat combina il fascino alpino ad arredi contemporanei: per i mobili si affida all'azienda italiana Minotti, per l'illuminazione a Contardi.

Per questo hotel sono state selezionate sette modelli della collezione: Flexiled AP, Athena TA e Quadra Desk per la zona letto, Quadra Liseuse e Kubric SO Single o Cluster per l'area soggiorno, le Muse per la piscina al coperto.

Progetto di **Reinhard Strasser**.

*Officially opened in 2016 in Stubenbach, the five-star SEVERIN\*S The Alpine Retreat hotel offers a unique experience of luxury, quality and exceptional comfort to its guests.*

*Clad in antique Tyrolean wood with a stone façade, SEVERIN\*S - The Alpine Retreat blends effortlessly into Lech's beautiful landscape, with special care to the use of traditional building materials and a combination of alpine charm and contemporary interiors. The furniture is by the Italian company Minotti, while the lamps by Contardi.*

*Seven models of Contardi's collection have been selected for this hotel: Flexiled AP, Athena TA and Quadra Desk for the bedrooms, Quadra Liseuse and Kubric So Single or Cluster for the living area, Muse Ta for the indoor swimming pool.*

*Project by **Reinhard Strasser**.*



Kubric SO: struttura bronzo con diffusore in vetro metallizzato bronzo e interno plissé oro.

*Kubric SO: satin bronze body with diffusing bronzed glass, gold pleated lining.*



Kubric SO Cluster of 5: versione bronzo con diffusore in vetro metallizzato bronzo e interno plissé oro.

*Kubric SO Cluster of 5: bronze version with diffusing bronzed glass, gold pleated lining.*



Flexiled AP: pelle nera e basetta bronzo spazzolato.

*Flexiled AP: black leather and satin bronze base.*



Quadra Desk: struttura bronzo spazzolato e paralume in cotone bianco.

*Quadra Desk: satin bronze body and white cotton shade.*



## EXCELSIOR HOTEL - PESARO (IT)

Lusso discreto e un concept intimo e accogliente. L'Hotel Excelsior di Pesaro è un 5 stelle di prestigio, incastonato fra le palazzine anni '50 della riviera di Pesaro. La regia di **Andrea Fogli** nella progettazione di ogni spazio e nella composizione degli arredi sta alla base dell'effetto armonioso ed equilibrato che l'Hotel Excelsior riesce a comunicare. Per l'occasione Andrea Fogli disegna le lampade e affida la realizzazione a Contardi: prende vita Tata, lampada da terra e da muro che entra a far parte della collezione standard di Contardi.

*Discreet luxury and cosy concept. The Excelsior Hotel in Pesaro is a prestigious 5-star hotel nestling among the 50s buildings of the Pesaro Riviera. **Andrea Fogli** has directed the whole design project giving a harmonious and balanced effect of all the spaces thanks to the furniture he has selected. For the occasion, Andrea Fogli designed the lamps and entrusted the realisation to Contardi: the floor and wall lamp Tata came to life, joining Contardi standard collection.*



Silhouette FL: struttura in metallo verniciato bianco lucido. Paralume in tessuto percaline bianco con interno oro. Design by Didier Raimbault.

*Silhouette FL: glossy white lacquered metal body lacquered. Shade in white "percaline" fabric with gold lining. Design by Didier Raimbault.*



# RECEPTION



Quadra Liseuse: struttura cromo e paralume in cotone bianco.

*Quadra Liseuse: chrome body and white cotton shade.*



Circus SO: paralume in shantung avorio, rosone nickel spazzolato.

*Circus SO: ivory shantung shade and satin nickel rosette.*





Tata AP: struttura cromo. Coni riflettori nero opaco - interno bianco.  
Doppia emissione. Orientabile.

*Tata AP: chrome body. Matt black - white internal reflector.  
Double light. Adjustable.*





## CASE STUDY: VALUE ENGINEERED

### Turin Palace Hotel - Turin (IT)

---

L'albergo, costruito nel 1872, riaperto a Maggio 2015, è stato sottoposto a una radicale ristrutturazione che lo ha restituito a Torino come uno degli alberghi di riferimento della città.

Il nuovo Turin Palace Hotel mette in luce i dettagli dell'interior studiati dall'architetto **Patrizia Poli**, esperta di hospitality design, e da **Margherita Marzot** che hanno scelto arredi lucidi e laccati e impronte d'arte contemporanea. Nella hall si trovano le Coco Mega TA, il desk della reception è illuminato da due Treasure TA Deluxe mentre le camere sono fornite di lampade da tavolo e da terra Audrey, nella versione V.E.

*As a renewed place of charm and relax, the Turin Palace Hotel has reconquered the glory and fame, which had earned it a leading role in the history of Turin hospitality.*

*The new Turin Palace Hotel highlights the details of the interiors designed by Architect **Patrizia Poli**, an expert in hospitality design, and **Margherita Marzot**.*

*They chose shiny, lacquered furniture and contemporary art's marks.*

*Coco Mega TA lamps are set in the hall near the armchairs, two Treasure TA Deluxe illuminate the reception desk, while the rooms are lighted up by Audrey floor and table lamps, in the V.E. version.*



Coco Mega TA: paralume in percaline bianco e struttura cromo. Specchio incassato nella base.

*Coco Mega TA: white percaline shade and chrome body. Silver mirror, recessed into the base.*



## ESIGENZE DI BUDGET / MEET THE BUDGET

Modifiche / modifications:

- ① Dimensione base (più bassa) / Base dimension (smaller height)
- ② Stelo laccato nero (non più rivestito con cordone in seta nera / Black lacquered stem (not yet covered by black braided silky cord)
- ③ Dimensioni e materiali paralume (uso del cotone al posto del velluto) / Shade dimensions and materials (no more velvet, but cotton)

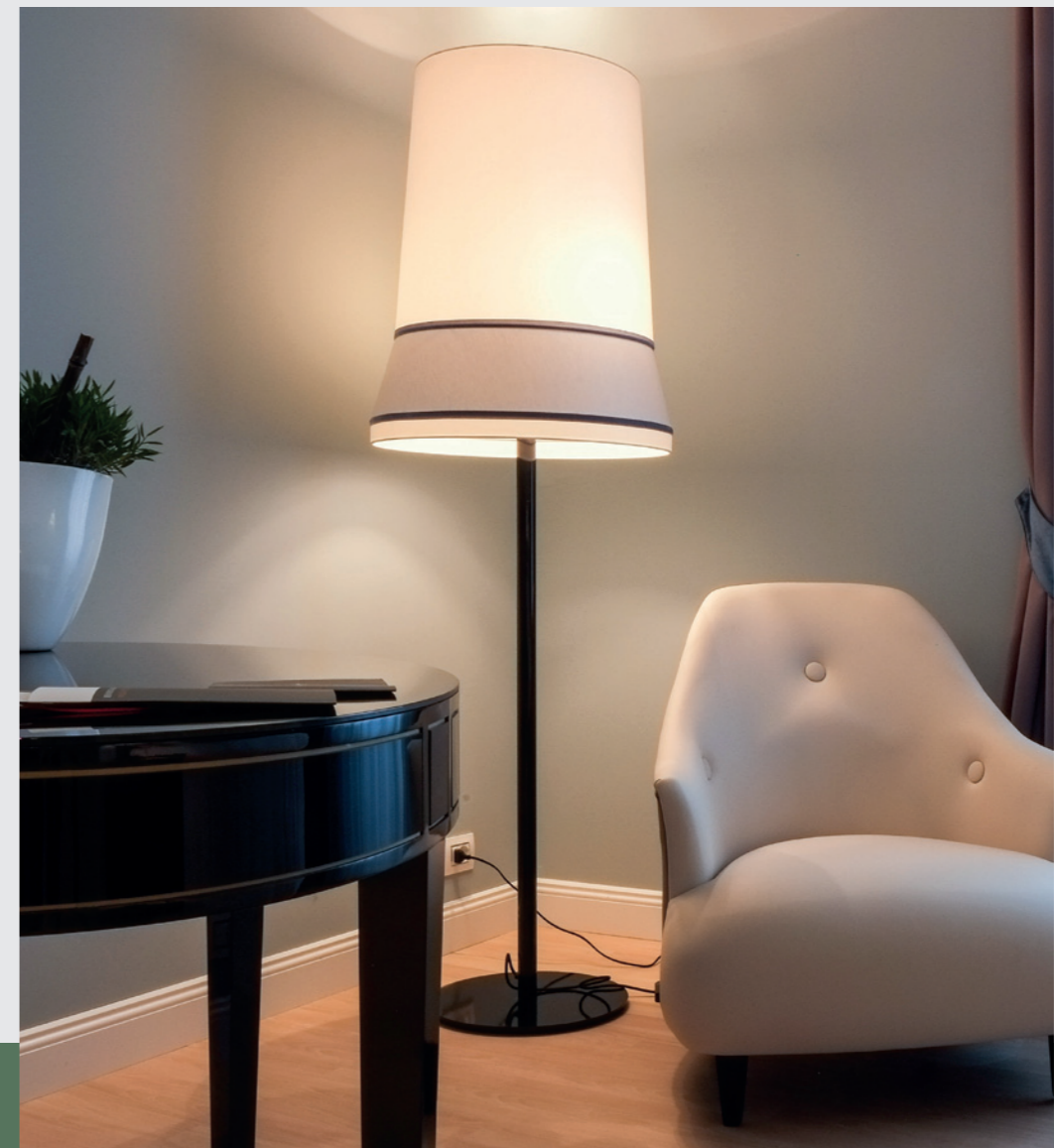

Audrey FL Special

Audrey TA Special

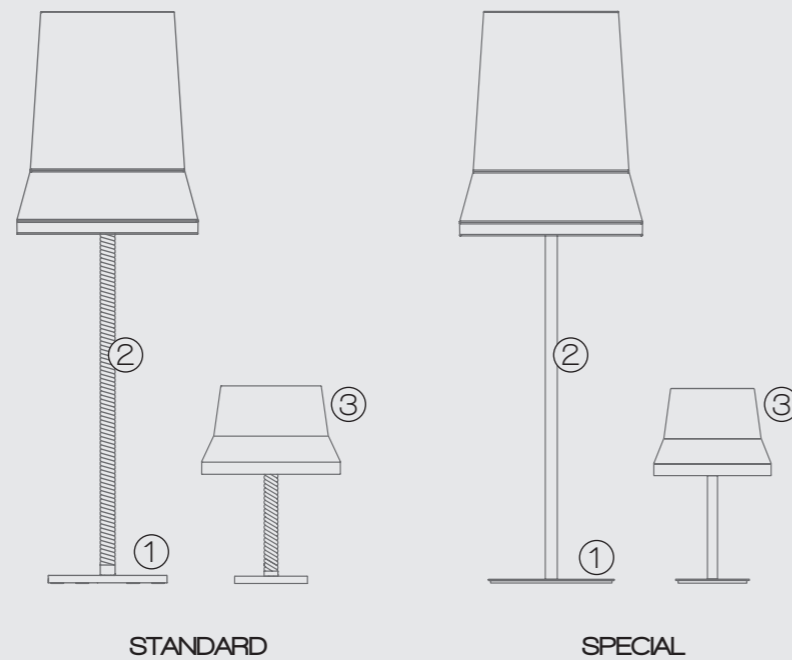



## ATLANTIS HOTEL BY GIARDINO - ZURICH

---

Una struttura urbana a pochi passi dalla natura, l'Atlantis by Giardino centra il giusto equilibrio tra questi due mondi. Completamente rinnovato, questo hotel a 5\* stelle di Zurigo vanta 95 camere e suite esclusive dal design moderno. Nuovi arredi e apparecchi di illuminazione sono stati disegnati da **HBA London** e realizzati rispettivamente dalle aziende italiane Molteni e Contardi Lighting.

*As an urban retreat a few steps away from the nature, Atlantis by Giardino sets the perfect balance between these two worlds. This completely renovated five-stars hotel in Zurich boasts 95 exclusive rooms and suites characterised by a modern design. New furnishings and lighting fixtures were designed by **HBA London** and manufactured, respectively, by the Italian companies Molteni and Contardi Lighting.*



Lampada da tavolo con tubi in plexiglass trasparente. Paralume in lino avorio.

*Table lamp with clear acrylic rods. Ivory linen shade.*



# RESTAURANTS

- NOVIKOV RESTAURANT - MIAMI (USA)
- ELIMAR BAR & RESTAURANT - VENICE (IT)
- MALASPINA RESTAURANT - PARMA (IT)
- 59 RESTAURANT - PESARO (IT)
- PIX PINTXOS - LONDON (UK)
- LES PETITES MADELEINES - TURIN (IT)
- THE NORDIC GRILL - MILAN (IT)
- DABASS BAR & RESTAURANT - MILAN (IT)
- LES LOGES BAR & RESTAURANT - MONTPELLIER (FR)



## NOVIKOV RESTAURANT & BAR - MIAMI (USA)

Aprire il prestigioso Novikov Restaurant & Bar, nel cuore di Miami, su progetto del designer di fama internazionale **Adam D. Tihany**. Un ambiente glamour ed energetico. L'illuminazione di ogni ambiente è stata affidata a Contardi che, su disegno del designer, ha realizzato sospensioni XL dalle forme geometriche e dai pattern vivaci ed una versione speciale della lampada Messalina Chandelier in cui i vetri sono direzionati verso il basso per una spot light sul piano di lavoro del bancone.

*Novikov Restaurant & Bar is now open in Miami, a project by the internationally renowned hospitality designer **Adam D. Tihany**. A glamorous and high-energy setting. The lighting project has been entrusted to Contardi which creates, on designer's drawing, several extra-large pendant lamps with geometric shapes and bright colours and a special version of Messalina Chandelier lamp: the glass diffusers are directed downwards for a spot light on the counter.*





## CASE STUDY: MODIFIED STOCK

### Elimar Beach Bar & Restaurant - Venice (IT)

Una selezione di luci tropicali e fantasiose di Contardi riscalda il nuovo Elimar Beach Bar & Restaurant, inaugurato lo scorso Luglio all'interno del prestigioso Hotel Excelsior di Venezia.

Il progetto è stato seguito dal rinomato studio **Richmond International** che ne realizza un design di tendenza dal retrogusto esotico.

*A tropical and fancy lighting selection by Contardi warms up the new Elimar Beach Bar & Restaurant at the prestigious Hotel Excelsior in Venice. The project was conceived by the renowned **Richmond International** studio, which creates a trendy design with an exotic aftertaste.*



Lampada a sospensione su misura con struttura dorata verniciata a polvere e diffusore satinato.

*Custom-made pendant lamp with gold powder coating frame and frosted diffuser.*



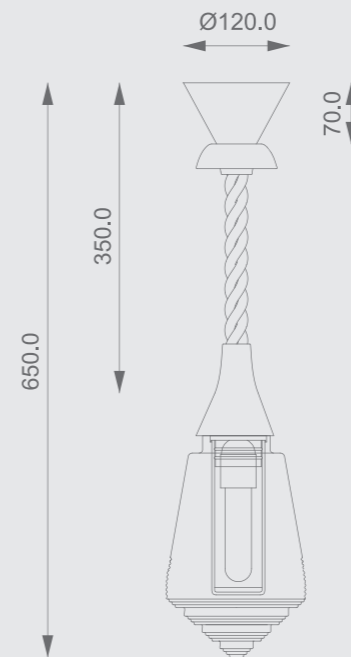
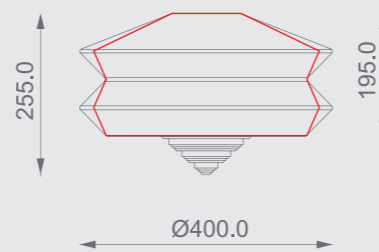
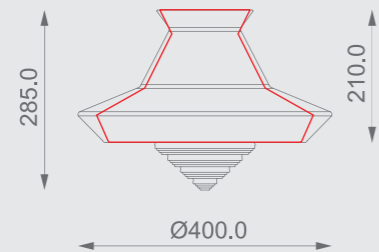
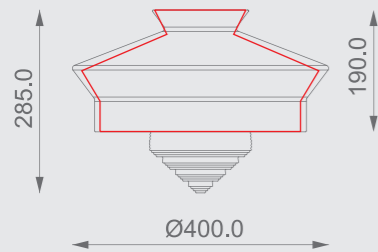

MODIFIED STOCK



STANDARD



Calypso SO con cavo speciale:  
la tige in ottone è stata eliminata e la lunghezza del cordone ridotta.  
I pardumi presentano dimensioni leggermente superiori alla versione standard e accostamenti di patterns speciali su richiesta del designer.

*Calypso SO special cable:  
the brass tige has been removed and the length of braided cord has been reduced.  
Shades have slightly bigger sizes than the priginal version and special patterns combinations, on designer's demand.*



## MALASPINA RESTAURANT - PARMA (IT)

Il progetto architettonico e di arredamento di **Maurizio Di Mauro** riprende l'idea del tradizionale bistrot tipico dei primi anni del '900, rinnovandone il look grazie alla combinazione di materiali classici con uno studio illuminotecnico in collaborazione con **Marcello Colli**.

Pur mantenendo un filo conduttore, ogni ambiente assume una diversa caratterizzazione estetica e cromatica, enfatizzata dall'utilizzo di Solitario in differenti variazioni, standard e custom: la versione a plafone con lenti per accentuare il chiaroscuro, le applique su misura, calate direttamente sui tavoli con bracci direzionabili, ed infine le sospensioni e lo chandelier.

*The architectural and interior design concept by **Maurizio Di Mauro** takes the idea of the traditional bistrot of the beginnings of '900 and renovate its look thanks to the combination of classic materials with lighting project in collaboration with **Marcello Colli**.*

*Each room is chromatically and aesthetically characterised, yet keeping a main theme, also highlighted by the use of Solitario in different variations, standard and custom: the ceiling lights with lenses to emphasise the light and dark contrast, the bespoke wall sconces where the lights hang directly over the tables thanks to swivelling arms, and finally the pendant lights and the chandelier.*



Chandelier a 8 bracci con struttura in bronzo spazzolato chiaro e sfere Solitario in finitura speciale sabbato bianco.

*8-arm chandelier with light satin bronze body and Solitario spheres in special all-frosted finish.*



V.E.

Soltario applique speciali  
direzionabili con braccio tubolare  
curvato.

*Soltario special adjustable wall  
sconces with curved tubular arm.*

STD

Sistema Soltario SO con strutture in finitura  
bronzo spazzolato chiaro, sfere Spot e  
accessori.

*Soltario SO system with light satin bronze  
structures, Spot spheres and accessories.*



## 59 RESTAURANT & IL BISTRO' - PESARO (IT)

---

Il ristorante dalle linee moderne rievoca il glamour di fine anni '50, la dolce vita e la spensieratezza di quei tempi, mentre il bistrò ha i tratti di un lounge bar e lo stile di una bakery newyorkese. Entrambi sono stati progettati dall'Arch. **Andrea Fogli** ed interamente illuminati dalle lampade Contardi.

*The modern restaurant evokes the glamor of the late 50s, the sweet life and the carefreeness of those times. The bistrò has the features of a lounge bar and the style of a New York bakery. Both locations have been designed by arch. **Andrea Fogli** and entirely illuminated by Contardi lamps.*





## PIX PINTXOS - LONDON (UK)

---

Questo piccolo bar di tapas situato lungo Carnaby Street, a Londra, è l'ultimo punto vendita della catena di bar Pix. Lo studio di interior design **Duck & Shed** ha scelto le sospensioni Cornelia di Contardi per illuminare il bancone e la vetrina.

*This small tapas bar located in Carnaby street, is the latest addition to the Pix bars chain. The interior design studio **Duck & Shed** has chosen Cornelia pendant lamps by Contardi to light up the bar counter and the windows.*





## LES PETITES MADELEINES - TURIN (IT)

Nel Febbraio del 2016 il Turin Palace Hotel ha completato la sua offerta con l'apertura del ristorante gourmet Les Petites Madeleines. Gli interni sono stati affidati all'architetto **Patrizia Poli** e a **Margherita Marzot** che si hanno scelto installazioni luminose di grande impatto: per il ristorante sono state selezionate Muse Lantern SO, Messalina AP e Cornelia FL di Contardi nella finitura bronzo.

*On February 2016 the Turin Palace Hotel completed its offer with the opening of Les Petites Madeleines. The interiors were entrusted to the architect Patrizia Poli and Margherita Marzot who chose lighting fixtures of great impact: Contardi supplied the restaurant with Muse Lantern SO, Messalina AP and Cornelia FL in bronze finish.*





## THE NORDIC GRILL - MILAN (IT)

Nordic Grill è la tipica steakhouse dei paesi del Nord, un locale unico dove cucina e design si legano creando un ambiente caldo ed elegante. La cucina aperta sul living, con la grande griglia sempre accesa, il camino e l'angolo per ascoltare la musica e rilassarsi sul divano sono illuminati dalle lampade Divina di Contardi: piantane, applique e sospensioni dal classico paralume plissettato color crema.

*Nordic Grill is the typical steakhouse of the Northern Countries, a unique place where cuisine and design mix together creating a warm and elegant atmosphere. The open kitchen on the living room, with the large grill always on, the fireplace and the relax corner where you can listen to music sitting on the sofas are illuminated by Divina lamps by Contardi: floor lamps, wall sconces and pendant lamps with classic cream-colored pleated shade.*





## DABASS BAR & RESTAURANT - MILAN (IT)

---

Il Dabass di Milano nasce da un'idea di tre imprenditori che hanno trasformato un'ex cartoleria in un ristorante accogliente dall'anima artistica e intima. In stile retrò, il locale stupisce i presenti grazie a lampade icona della collezione Contardi: le Calypso SO e Kubric SO illuminano i tavoli, mentre le Treasure SO Deluxe impreziosiscono il bancone.

*Dabass in Milan was born from an idea of three entrepreneurs who have transformed a former bookshop into a cosy restaurant with an artistic and intimate soul. The retro-styled location enchants thanks to several iconic pieces of Contardi collection: Calypso SO and Kubric SO illuminate the dining tables, while Treasure SO Deluxe lamps enrich the counter.*







## LES LOGES BAR & RESTAURANT - MONTPELLIER (FR)

Il bar e ristorante "Les Loges" risiede nel rinomato Grand Hotel Du Midi di Montpellier. La ristrutturazione è stata affidata all'architetto **Julie Gauthron** che per questo progetto si ispira ai concetti di movimento, melodia e ritmo. Il soffitto del Les Loges è completamente illuminato da lampade a sospensione Messalina SO di Contardi; le pareti invece sono impreziosite da lampade applique disegnate su misura.

*Les Loges Bar & Restaurant is located in the renowned Grand Hotel Du Midi in Montpellier. The renovation was entrusted to the architect **Julie Gauthron**. Her project was inspired by the concepts of movement, melody and rhythm. The ceiling of Les Loges is completely illuminated by Messalina SO pendant lamps by Contardi. Instead, the walls are instead equipped with custom-made wall lamps.*





# RESIDENTIAL

- VILLA OISEAU BLEU - COTE D'AZUR (FR)
- RIVERSTONE RESIDENTIAL COMPLEX - KIEV (UA)
- NOTARY HOUSE - TILBURG (NL)
- L'ELEGANCE - COTE D'AZUR (FR)
- OKYRHOE VILLA - MYKONOS (GR)
- FAMILY HOUSE - TILBURG (NL)
- HOLIDAYS VILLA - ALGARVE (PT)
- PARKSIDE - HONG KONG (CN)



## CASE STUDY: HOW TO USE CONTARDI

### Villa Oiseau Bleu - Côte D'Azur (FR)

---

Villa Oiseau Bleu è una lussuosa villa privata in Villefranche con vista mozzafiato sul mare della Costa Azzurra. Gli ambienti interni, a cura di Marie Pierre Martin Charpenel (MPMC DESIGN), sono illuminati unicamente da lampade Contardi con limitato impiego di illuminazione architettonica: una chiara dimostrazione del fatto che le lampade Contardi non siano solo decorative ma anche funzionali.

*Oiseau Bleu Villa is a luxurious private villa in Villefranche with a breathtaking view on the French riviera, designed by Marie Pierre Martin Charpenel (MPMC DESIGN).*

*Contardi has been selected to illuminate all the indoor areas where the need of architectural lighting was limited. A clear example that shows that Contardi lamps are not only decorative but also functional.*



#### SALA DA PRANZO / DINING ROOM:

Belle SO: illuminazione diretta e diffusa sul tavolo da pranzo.

*Belle SO: direct and diffused lighting on the dining table.*



**INGRESSO / ENTRANCE**

Eclisse SO: doppia illuminazione, diretta (rosone centrale) ed emozionale (dischi laterali), con doppio comando.

*Eclisse SO: two independent light sources, direct from the capony and emotional from the discs. Double switch.*



CAMERA DA LETTO 1 / BEDROOM 1:

Duos AP: doppia illuminazione con faretto orientabile per lettura ed una luce diffusa. Doppio comando indipendente.

*Duos AP: double lighting, one orientable spotlight for reading and one diffused light. Independed double switch.*





**CAMERA DA LETTO 2 / BEDROOM 2:**

Quadra AP Mini + Quadra TA:  
soluzione classica con abajour per comodino e passaggio.

*Quadra AP Mini + Quadra TA:  
traditional solution with abajour for bedside and passage.*



**BAGNO / BATHROOM:**

Appliche speciale per  
area bagno. IP44.

*Special wall sconce for  
bathroom with IP44 rate.*



## Walnut Apartments – London (UK)

Il creatore di concept di lusso **Harrison Varma** ha realizzato una premiata collezione di tre attici, sei appartamenti duplex e undici appartamenti laterali in un sito di 2,5 ettari con giardini paesaggistici privati e strutture eccezionali tra cui una piscina coperta da 25 metri, spa, cinema e altro ancora. Questo complesso residenziale è situato a Londra, nella famosa Bishops Avenue, anche nota come "via dei milionari". Tutti gli ambienti sono arredati con mobili delle aziende italiane Porada e Giorgetti ed illuminati dalle lampade Contardi. Un'importante testimonianza di come poter illuminare un intero progetto residenziale solo con prodotti Contardi.

*Luxury developer **Harrison Varma** has created an award-winning collection of three penthouses, six duplexes and eleven lateral apartments set in a 2.5 acre site with private landscaped gardens and outstanding facilities including an indoor 25m pool, spa, cinema and more. This residential complex is placed in London, at The Bishops Avenue, also known as billionaires row. The furniture is by the Italian companies Porada and Giorgetti, while all the rooms are illuminated by Contardi's lamps. A project example that shows how lighting up a whole residential project only with Contardi's products.*



Eclisse SO: struttura in legno finitura bronzo spazzolato e bronzo spazzolato chiaro. Doppia illuminazione indipendente.

*Eclisse SO: light satin bronze and satin bronze wood body. Two independent light sources, double switch.*



Vegas SO: rosone in bronzo. Anelli in legno con finitura bronzo e bronzo chiaro. Dischi diffusori in alicrite effetto alabastro.

Vegas SO: bronze canopy. Bronze and light bronze wood rings. Diffuser disc in alicrite, alabaster effect.







Stardust SO Small: struttura bronzo spazzolato chiaro e diffusore in vetro bianco. Luce diretta e indiretta.

*Stardust SO Small: light satin bronze body. White glass diffuser. Direct or indirect lighting.*



Clessidra So Kayros: struttura in bronzo spazzolato. Vetro soffiato: bronzo superiore e metallizzato bronzo inferiore. Diffusore bianco lucido.

*Clessidra So Kayros: satin bronze body. Hand blown glass polished bronze upper glass and diffusing bronzed lower glass. Top diffuser polished white.*





Cornelia SO: struttura bronzo spazzolato.  
Vetro metallizzato bronzo.

Cornelia SO: satin bronze body.  
Diffusing bronzed glass.



Up Desk: struttura bronzo spazzolato con dettagli in ottone. Stelo in corda in seta intrecciata color miele.

*Up Desk: satin bronze body with satin brass details. Stem covered by braided silky cord, honey colour.*





Audrey TA Medium: paralume in cotone e velluto avorio e passamaneria in seta nera.

*Audrey TA Medium: ivory cotton and velvet shade with black silky trim.*



## RIVERSTONE RESIDENTIAL COMPLEX - KIEV (UA)

RiverStone è un complesso residenziale a Kiev composto da diverse unità abitative.

La società **Freedom**, rappresentante ufficiale in Ucraina di aziende di mobili italiane e tedesche d'élite, ha rifornito uno degli appartamenti selezionando svariati prodotti della collezione standard di Contardi: Solitario SO, Solitario AP, Flexiled FL e Flexiled AP per le camere; Bach Ap nel corridoio d'ingresso; Stardust SO Small e Muse Lantern per il soggiorno; Supermirror SO per la cucina.

*RiverStone is a residential complex in Kiev consisting of several housing units.*

*Freedom, the official representative in Ukraine of several Italian and German furniture companies, has supplied one of these apartments, choosing many products from Contardi standard collection: Solitario SO, Solitario AP, Flexiled FL and Flexiled AP for the bedrooms; Bach Ap for the corridor at the entrance; Stardust SO Small and Muse Lantern for the living room; Supermirror SO for the kitchen.*



Solitario SO System: sistema di illuminazione con una sola uscita elettrica composto da cinque solitario SO finitura nickel nero e vetro diffusore fumé.

*Solitario SO System: lighting system with one electrical output composed by five solitario SO in black nickel finish and smoked diffuser glass.*



Flexiled AP & Flexiled FL: versione in pelle avorio e base nickel satinato.  
*Flexiled AP & Flexiled FL: ivory leather arm and satin nickel base.*



Muse Lantern: struttura bronzo spazzolato, maniglia in seta intrecciata color miele.

*Muse Lantern: satin bronze frame, braided silk handle, dark honey colour.*



Stardust So Small: chandelier bronzo spazzolato chiaro.

*Stardust So Small: light satin bronze chandelier.*





## NOTARY HOUSE - TILBURG (NL)

---

Residenza privata a Tilburg, realizzata su progetto dello studio **BenchMark Design**. Il contrasto di materiali naturali e di tinte calde e tenui permea in tutto il progetto.

Audrey SO diventa protagonista della luminosa sala da pranzo grazie alla combinazione di velluto, seta e lino con cui è composto il suo paralume. Il soggiorno è invece illuminato da Audrey TA Medium e M.me Butterfly FL.

*Private residence in Tilburg, designed by **BenchMark Design** studio. The contrast of natural materials and warm and soft nuances influences the whole project.*

*Audrey SO becomes the protagonist of the bright dining room thanks to the combination of velvet, silk and linen of its shade. The living room is illuminated by Audrey TA Medium and M.me Butterfly FL.*



Audrey SO: lampada a sospensione con un importante paralume in velluto e lino con passamanerie in seta.

*Audrey SO: pendant light with a huge shade in velvet and linen with silky trims.*





M.me Butterfly FL: stelo in legno, finitura grigio "canna da fucile" lucido. Paralume in seta color avorio.

M.me Butterfly FL: polished gunmetal grey wood stem. Ivory silk shade.



## L'ELEGANCE - CÔTE D'AZUR (FR)

---

Lo studio di interior design **Collection Privée** di Cannes firma il progetto di interni di questa lussuosa villa privata in Francia, dal look contemporaneo e dai materiali nobili.

Le camere da letto sono illuminate dalle lampade da lettura **Flexled AP**, prodotto icona di Contardi, e dalle lampade d'appoggio **Athena TA**, che esaltano l'eleganza degli arredi.

Nell'area relax, **Coconette AP** regala un'atmosfera calda e accogliente.

*Collection Privée, interior designer in Cannes, signs the interior project of this luxurious private villa in France, with a contemporary look and noble materials.*

*The bedrooms are illuminated by Flexled AP reading light, an icon in Contardi Collection, and by Athena TA table lamps, enhancing the elegance of the furnishings.*

*In the relax area, Coconette AP donates a warm and cosy atmosphere.*



Coconette AP: struttura in bronzo spazzolato e paralume in cotone bianco.

Coconette AP: satin bronze body and white cotton shade.



STD

Flexled AP: versione pelle nera con interruttore sulla base.

*Flexled AP: black leather arm, switch on the base.*

STD

Athena TA: struttura nickel nero e base in rovere marrone scuro. Paralume percaline bianco.

*Athena TA: black nickel body and dark brown oak base. White percaline shade.*





## OKYRHOE VILLA - MYKONOS (GR)

---

Okyroe è una splendida struttura con vista sull'oceano, a pochi passi dalla famosa spiaggia Kapari, in Grecia. I pavimenti in marmo bianco intagliato, i bianchi tendaggi e le sedute offrono un ambiente ventilato e spensierato. Gli alti soffitti a volta e gli archi ricordano invece un'epoca più romantica. Per questo ambiente "total white" **Lucrezia Binaghi**, personal shopper & interior designer, si affida ad alcune icone di Contardi, simbolo della maestria sartoriale del brand: Cloche SO, Audrey SO, Audrey TA Medium e Calypso SO.

*Okyroe is a stunning oceanfront property located few steps away from the famous sandy beach of Kapari in Greece. Carved white marble floors, white curtains and white upholstered chairs provide a breezy and carefree ambience. High vaulted ceilings and white archways are reminiscent of a more romantic era. For this "total white" property **Lucrezia Binaghi**, personal shopper & interior designer, has selected some Contardi icons which are the best example of the brand's tailoring skill: Cloche SO, Audrey SO, Audrey TA Medium and Calypso SO.*



Audrey SO: il paralume in velluto e lino con passamanerie in seta ricorda il cappello indossato da Audrey Hepburn in "Colazione da Tiffany".

*Audrey SO: the shade in velvet and linen with silk trims reminds the hat worn by Audrey Hepburn in "Breakfast at Tiffany's".*



Calypso SO: paralume MARTINIQUE nella versione "Building".

Calypso SO: MARTINIQUE shade in "Building" finish.



## THE FAMILY HOUSE - TILBURG

---

Una grande casa famiglia nel sud dell'Olanda circondata da boschi pensata non come una casa-museo dove non si può toccare nulla ma un'abitazione adatta ad accogliere bambini. La sala da pranzo è il vero cuore della casa. Progetto di **John MacDonald Interior - Outdoor in the Netherlands**.

*A large family house in the south of the Netherlands surrounded by woods designed to be not a museum-house where you can not touch anything but a cosy accomodation suitable for children . The dining room is really the heart of the house. Project by **John MacDonald Interior - Outdoor in the Netherlands**.*



Audrey FL: paralume in cotone e velluto avorio e passamaneria in seta nera.

*Audrey FL: ivory cotton and velvet shade with black silky trim.*



Due sistemi Solitario composti da cinque solitario SO ciascuno. Finitura nickel nero e vetri diffusori fumé.

*Two Solitario SO Systems, each composed by five solitario SO. Black nickel finish and smoked diffuser glasses.*



## HOLIDAY VILLA – ALGARVE

---

Una lussuosa villa vacanza in Algarve (Portogallo) caratterizzata dall'imponente facciata bianca e dalla spettacolare piscina che regala un'atmosfera serena, quasi magica. Il progetto di questa villa, realizzata dallo studio londinese **Stephenson Wright**, include lampade a sospensione e a batteria della famiglia Muse per l'illuminazione degli esterni.

*A luxurious holiday villa in Algarve (Portugal) characterised by the imposing white facade and the amazing swimming pool that offers a serene, almost magical atmosphere. The design project by the London-based studio **Stephenson Wright**, includes Muse suspension and battery lamps by Contardi for lighting up the external area.*



Muse Battery Outdoor: lanterna a batteria nella finitura bianca.

*Muse Battery Outdoor: battery-operated lantern in white finish..*





Muse SO Outdoor: struttura e catena laccata bianca e cavo in pelle nera. IP65  
Muse SO Outdoor: white body and metal chain. Black leather cable. IP65



## PARKSIDE – HONG KONG (CN)

Parkside è uno spazio abitativo di più di 150 mq di forma rettangolare sito a Hong Kong e progettato da **Ks Studio LTD**. L'uso di forme geometriche contrastanti e di materiali e finiture divergenti tra loro sta alla base del concept del progetto. La carta da parati metallica lucida e il robusto soffitto in cemento lavorato con motivi geometrici si pone in contrasto con la morbidezza degli enormi tendaggi. Stardust So Small di Contardi è la scelta perfetta per questo soggiorno, interamente illuminato dalla lampada a sospensione.

La finitura metallica dello chandelier si fonde perfettamente con lo spazio contribuendo al distinto senso di calore e freddezza.

*Parkside is a 1700-square-foot rectangular-shaped living space in Hong Kong projected by **Ks Studio LTD**. Divergence of material use and geometric shapes are the principles on which the project concept is based. The employment of polished metallic wallpaper and geometrical pattern marked on rugged concrete ceiling contrast with the softness of the huge curtains.*

*Stardust So Small by Contardi is the perfect choice for this living room, entirely illuminated by this pendant light.*

*The metallic finish of the chandelier blends perfectly with the space contributing to distinct sense of warmth and coldness.*



Stardust SO Small: struttura in bronzo spazzolato chiaro. Doppia illuminazione indipendente.

*Stardust SO Small: light satin bronze body. Two independent light sources, double switch.*



# YACHTS

- MY POLAR STAR SUPERYACHT
- AZIMUT YACHT 77S
- AZIMUT YACHT AZ50
- LADY SOUL YACHT
- MY SILVER FAST YACHT



LAMPADE PER USO NAVALE /  
MARINE USE LAMPS

EN-60598-1 : 2015 + A1 : 2018

EN-60598-2-1 : 1989

IEC60092-306 : 2099

RINA rules : 2018 Pt C, Ch 3 Sec 6



## MY POLAR STAR SUPERYACHT

Costruito dalla Lürssen in Germania, MY Polar Star è uno yacht di lusso di 65 metri di lunghezza.

L'interior design è stato interamente progettato dallo studio **FM Architettura D'Interni** in collaborazione con Espen Oeino. Per l'illuminazione delle aree comuni esterne (il bar sul flybridge, l'ingresso principale e l'area relax con jacuzzi) sono state selezionate numerose Muse Battery, lampada a batteria di Contardi con crescenti applicazioni nel settore navale.

*Built by Lürssen in Germany, MY Polar Star is a 65-meter luxury yacht. The interior design was entirely designed by **FM Architettura d'Interni** in collaboration with Espen Oeino. Muse Battery lamps by Contardi have been selected to light up the external public areas: the bar counter on the flybridge, the main entrance and the relax area with a jacuzzi. Muse Battery represents one of the most requested products in the naval field.*



Muse Battery Outdoor: lanterna a batteria nella finitura bianca.

*Muse Battery Outdoor: battery-operated lantern in white finish..*





## AZIMUT YACHT AZ50

---

Il motor yacht Azimut 50 del rinomato gruppo Azimut Benetti ha un perfetto equilibrio tra eleganza e comfort. Interni in ciliegio ed arredi moderni, studiati per offrire agio e comodità in ogni situazione.

Per questo yacht l'architetto **Carlo Galeazzi** sceglie Duos Ap: lampada da lettura o d'ambiente con asticella metallica che dirige e orienta la sorgente luminosa per la lettura.

*Azimut Yacht 50 is a motor yacht of the renowned Azimut Benetti group with a perfect balance between elegance and comfort. Cherry wood interiors and modern furnishings, designed to offer ease and luxury comfort in every situation.*

*For this project the architect **Carlo Galeazzi** chose Duos Ap: a reading or emotional lamp with a metal rod that directs and orients the light source for reading.*



Duos AP: versione cromo. Doppia illuminazione indipendente.

*Duos AP: chrome version. Double independent lighting.*



## AZIMUT YACHT 77S

Questo yacht del gruppo Azimut Benetti, vincitore del Cannes Yachting Festival del 2014, lungo 23 metri, dispone di quattro cabine, tutte con servizi privati e di un zona equipaggio. L'Arch. **Carlo Galeazzi** firma gli interni privilegiando finiture in legno scuro in essenza Zebrano, laccature avorio e tessuti color sabbia. Per l'illuminazione delle camere e dei servizi sceglie la applique Coco dalla collezione Contardi: lampada disegnata da Tristan Auer, caratterizzata da un design pulito abbinato a materiali eleganti.

*This yacht of Azimut Benetti group, winner of the 2014 Cannes Yachting Festival, with its 23 metres in length, has four cabins with private baths and a crew area.*

*The Arch. **Carlo Galeazzi** signs the interiors favoring dark wood finishes, ivory lacquers and sand-colored fabrics. For the lighting of rooms and baths, he chooses Coco wall lamp by Contardi: a lamp designed by Tristan Auer, characterised by a clean design combined with elegant materials.*



Coco AP: finitura cromo, pardume in lino.

*Coco AP: chrome finish, linen shade.*



## LADY SOUL YACHT

---

Lady Soul è uno yacht Ferretti di 30,8 metri, progettato da Zuccon International Project e caratterizzato da un bellissimo design contemporaneo e ampi spazi esterni. Gli interni in legno di quercia sono arredati con mobili in pelle color crema.

Le lampade da tavolo Audrey di Contardi, con i loro ricchi dettagli sartoriali, si abbinano perfettamente al design di questo elegante yacht.

*Lady Soul is a 30.8m Ferretti yacht, designed by Zuccon International Project, characterised by beautiful contemporary design and spacious outside areas. Cream leather furniture complement the oak wood interiors. Audrey table lamps by Contardi, with their rich tailoring details, match perfectly with the design of this elegant yacht.*



Audrey TA Large: paralume in cotone e velluto avorio e passamaneria in seta nera.

*Audrey TA Large: ivory cotton and velvet shade with black silky trim.*





## MY SILVER FAST YACHT

---

Silver Fast è un lussuoso yacht di 77m progettato dall'architetto navale di fama internazionale Espen Oeino con i magnifici ed eleganti interni di **Vain Interiors**. Completano il progetto splendidi arredi e pezzi d'arte. Contardi arreda questo yacht con le lampade da terra e da parete Flexiled.

*Silver Fast is a 77m luxury motor yacht designed by the internationally acclaimed Espen Oeino, with magnificent elegant interiors by **Vain Interiors**. It is complemented by a range of beautiful furnishings and art pieces. Contardi furnished this yacht with Flexiled floor and wall lamps.*



Flexiled FL: pelle nera e base in nickel satinato.

*Flexiled FL: black leather and satin nickel base.*

# THANKS TO...

---

## SPECIAL THANKS FOR PHOTO CREDITS:

Wilmotte & Associés Architects	Duck & Shed
Tony Chi	Julie Gauthron
Living Design	Marie Pierre Martin Charpenel
Loto AD Project	Harrison Varma
CCI Design	Freedom
Reinhard Strasser	BenchMark Design
Andrea Fogl	Collection Privee
Patrizia Poli	Lucrezia Binaghi
Margherita Marzot	John MacDonald
HBA London	Stephenson Wright
Adam D. Tihany	Ks Studio LTD
Richmond International	FM Architettura D'Interni
Maurizio Di Mauro	Carlo Galeazzi
Marcello Colli	Vain Interiors

## PHOTOGRAPHERS:

Mathieu Flol  
Guido Fuà  
Hugues Lagarde  
Libby Volgyes  
Alexandre Cousinier  
Stuart Pearce



CONTARDI LIGHTING SRL

Via A. Manzoni 134/140 | 20811 Cesano Maderno (MB)

contardi@contardi-italia.it | [www.contardi-italia.com](http://www.contardi-italia.com)