

BI-COMFORT

Concept Bed

® Altrenotti

est.1930

“Per noi il lusso non è
solo estetica o design,
è prendersi cura
del proprio benessere
ogni notte.”

Iwona Gutka

® **Altrenotti**
est.1930

1930

promuoviamo il comfort *promoting comfort*

Da quattro generazioni Altrenotti guarda al futuro facendo tesoro del proprio passato. Negli anni l'azienda ha ottenuto la **certificazione ISO 9001:2015**, riconoscimento internazionale per la gestione ed implementazione della qualità nei processi produttivi e per la soddisfazione dei clienti. Con orgoglio, oggi ha ottenuto la **certificazione di sostenibilità ISO 14001:2015**, grazie al continuo miglioramento delle performance ambientali e la maggiore competitività sul mercato. A conferma della sua volontà di operare con la massima trasparenza e responsabilità, Altrenotti ha inoltre ottenuto il **modello organizzativo D.Lgs 231**, che garantisce un sistema di gestione aziendale conforme ai più elevati standard di correttezza e controllo nella gestione dei bilanci. Questo percorso di crescita e innovazione trova espressione anche nel rinnovo dello showroom aziendale, un progetto che incarna il nuovo spirito di Altrenotti, sempre più orientato alla ricerca di materiali naturali e sostenibili.

For four generations, Altrenotti has looked to the future while honouring the value of its past. Over the years, the company has achieved **ISO 9001:2015 certification**, an internationally recognised standard that attests to the effective management and implementation of quality throughout its production processes, as well as to a strong commitment to customer satisfaction. Today, Altrenotti proudly holds the **ISO 14001:2015 environmental certification**, obtained through continuous improvement in environmental performance and a growing competitiveness in the market. As further evidence of its commitment to operating with the utmost transparency and responsibility, Altrenotti has also achieved **Legislative Decree 231 certification**, ensuring a corporate governance system that meets the highest standards of integrity, accountability and control in financial management. This ongoing journey of growth and innovation is also reflected in the renewal of the company showroom—a project that embodies the new spirit of Altrenotti, increasingly focused on the research and use of natural and sustainable materials.



Mario Domingo Panero



Rodolfo Lorenzo Panero



Mario Panero



Rodolfo Panero

sistemi di riposo

sleep systems

Alba Long Base Bauletto	28
Alba Long Base Fantasma	38
Alba Moyen Base Sommier a filo	48
Alba Voler Base Vela	58
Alba Voler Base Vela	68
Alba Haute Base Bauletto	80
Alba Petit Base Vela	90
Monforte Base Bauletto	100
Roddi Base Bauletto	110
Barbaresco Base Bauletto	120
Neive Base Vela	132
Neive Base Fantasma	144
Roero Base Bauletto	154
La Morra Base Fantasma	166
Lily Base Tradizionale	178
Sommier a Filo	186

poltrone

armchairs

Alba Bergère	196
Alba Poltroncina	202

materassi & topper

mattresses and topper

COLLEZIONE BI-NATURAL	219
<u>NATURAL SYSTEM</u>	
Bi-Vintage h.32	220
Bi-Green h.25	228
COLLEZIONE BI-COMFORT	237
<u>HYBRID SYSTEM</u>	
Bi-Power h.31	238
Bi-Progress h.31	244
Bi-Action h.26	250
<u>FOAM SYSTEM</u>	
Bi-Pore h.30	256
Bi-Flex h.25	262
<u>POCKET SYSTEM</u>	
Bi-Moon h.31	268
Bi-Mind h.26	274

piani di riposo

sleeping platforms

Bi-Metal	286
Bi-Wood	289
Bi-Wireless	290
Sommier a incasso	292
Sommier a filo	294

basi

bed bases

Vela	297
Fantasma	298
Tradizionale	301
Bauletto	302

biancheria

bed linen

Air WASH	306
Lino	311
Carezza	314
Satin Unito	319
Satin Jacquard	322
Texture	327

personalizzazioni

customizations

332

disegni tecnici

technical drawings

338

NUOVA VISIONE

new vision

Quest'anno insieme ad Altrenotti abbiamo dato vita a una collezione inedita, concepita per essere unica nel suo genere: un progetto capace di rispondere a qualsiasi esigenza di riposo.

Per dare vita a questa nuova collezione, abbiamo scelto di rivoluzionare l'approccio progettuale tradizionale, in cui il letto è il protagonista assoluto. La nostra filosofia, invece pone il materasso al centro del progetto: ogni elemento che lo circonda è studiato e sviluppato per amplificare comfort, benessere e qualità del riposo, esaltando la funzione primaria per cui il materasso è pensato.

Ogni elemento è intercambiabile, ogni dettaglio è studiato per offrire la massima libertà a chi lo sceglie, lasciando spazio alla creatività e alla personalizzazione.

In questa collezione, ogni testiera può essere abbinata a qualsiasi tipologia di base e piano di riposo, dando vita a infinite combinazioni estetiche e funzionali, per soddisfare ogni esigenza di gusto, comfort e praticità.

Oggi il mondo Altrenotti si rinnova con un nuovo gusto e una visione stilistica aggiornata. Ogni letto nasce dall'incontro tra tradizione artigianale e design contemporaneo. Insieme alla squadra di maestri artigiani dell'azienda, abbiamo lavorato su nuovi dettagli e inserti sartoriali, elevando il savoir-faire di Altrenotti a un livello ancora più alto.

Con Bi-Comfort Concept Bed partendo dalla scelta del materasso, del piano di riposo e della testiera si crea il sistema di riposo su misura adatto alle proprie esigenze armonizzando insieme comfort, benessere e design.

This year, together with Altrenotti, we have brought to life an entirely new collection, conceived to be truly one of a kind: a project designed to meet every possible sleep requirement.

To create this new collection, we chose to revolutionise the traditional design approach, where the bed takes centre stage. Our philosophy, instead, places the mattress at the heart of the project: every element surrounding it is conceived and developed to enhance comfort, wellbeing and sleep quality, fully expressing the mattress's primary function.

Every element is interchangeable, every detail carefully designed to offer maximum freedom of choice, leaving room for creativity and personalisation.

Within this collection, every headboard can be combined with any type of base and sleeping platform, creating endless aesthetic and functional combinations to satisfy every need in terms of style, comfort and practicality.

Today, the Altrenotti world is renewed with a refined taste and an updated stylistic vision. Each bed is born from the meeting of artisanal tradition and contemporary design. Together with the company's team of master craftsmen, we have worked on new details and tailored inserts, elevating Altrenotti's savoir-faire to an even higher level.

With Bi-Comfort Concept Bed, starting from the choice of the mattress, the sleeping platform and the headboard, it is possible to create a bespoke sleep system, perfectly tailored to individual needs by harmonising comfort, wellbeing and design.



Iwona Gutka

nuovo direttore artistico
new art director



Con il configuratore Altrenotti, puoi comporre il tuo sistema letto in modo semplice e personalizzato

Con il nostro configuratore puoi dare forma al tuo ideale di comfort: scegliere il letto, definire il materasso, armonizzare ogni dettaglio della biancheria. Un percorso intuitivo che ti guida nella creazione di uno spazio personale e autentico, dove materiali, colori e sensazioni si uniscono per raccontare il tuo stile e trasformare la camera da letto in un luogo davvero tuo.

Ogni scelta diventa un gesto creativo: puoi esplorare combinazioni, accostare finiture, lasciarti ispirare dalle texture. Il risultato è un ambiente che non solo accoglie, ma parla di te, delle tue abitudini, del tuo modo di vivere il riposo.

With our configurator, you can give shape to your ideal vision of comfort: choose the bed, define the mattress, and harmonise every detail of the bed linen. An intuitive journey that guides you in creating a personal and authentic space, where materials, colours and sensations come together to express your style and transform the bedroom into a place that truly feels your own.

Every choice becomes a creative gesture: you can explore combinations, pair finishes, and draw inspiration from textures. The result is an environment that not only welcomes you, but speaks of who you are—your habits and your personal way of experiencing rest.

With the Altrenotti configurator, you can effortlessly design your own bespoke sleep system

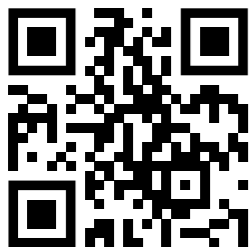

Il tuo sogno, fatto su misura

Your dream, made to measure

Immagina un letto che non segue regole prestabilite, ma le tue. Un sistema in cui materasso, piano di riposo, base e testiera diventano elementi di un'opera unica: la tua. Scegli il comfort che avvolge i tuoi sogni, il sostegno che accompagna ogni notte, i materiali e i colori che raccontano la tua storia. Ogni componente è intercambiabile, ogni dettaglio è configurabile, ogni combinazione è possibile. Il risultato è un letto che unisce design e benessere in un'armonia perfetta: creato da te e per te.

Imagine a bed that follows no preset rules—only yours. A system in which the mattress, sleeping platform, base and headboard become elements of a single, unique creation: yours. Choose the comfort that embraces your dreams, the support that accompanies every night, and the materials and colours that tell your story. Every component is interchangeable, every detail configurable, every combination possible. The result is a bed that brings together design and well-being in perfect harmony—created by you, for you.



Il cuore del riposo
è il materasso.

Piani di riposo, basi
e testiere ruotano attorno al
tuo benessere

*The heart of rest is the mattress.
Sleeping platforms, bases
and headboards revolve around
your wellbeing*

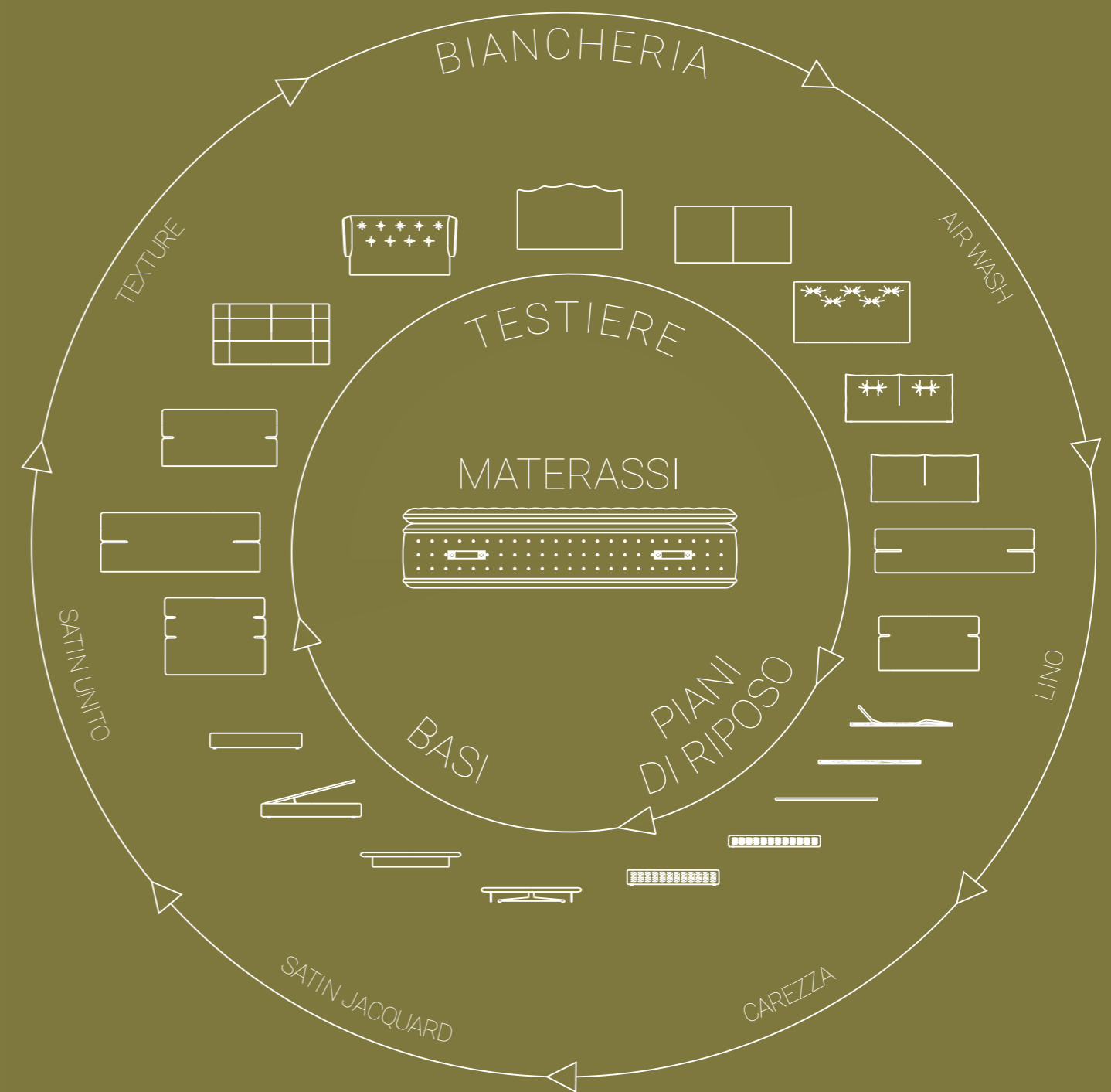



Perché il vero lusso non è dormire bene, ma dormire esattamente come vuoi tu

Because true luxury is not sleeping well, but sleeping exactly the way you want

Piani di riposo

Sleeping Platforms

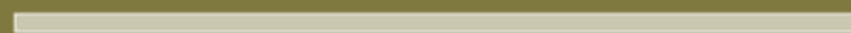

BI-METAL

La rete Bi-Metal, grazie alla sua struttura autoportante, assicura un elevato livello di stabilità ed è utilizzata come elemento strutturale della Base Vela.

Rete a doghe in legno multistrato di faggio curvato 38 + 8 doghe nelle versione matrimoniale complete di regolatori di rigidità, piano di riposo fisso con telaio in acciaio laminato a freddo.

BI-METAL

Bi-Metal Slatted Base, thanks to its self-supporting structure, the Bi-Metal slatted base ensures a high level of stability and is used as a structural element of the Vela Base. It features curved laminated beechwood slats—38 + 8 slats in the double version—complete with firmness regulators, and a fixed sleeping platform with a cold-rolled steel frame.



BI-WOOD

Rete in legno balancelle, piano di riposo fisso con telaio e doghe in faggio multistrato con regolatori di rigidità e supporti laterali a balancelle. La rete Bi-Wood è compatibile con le basi Tradizionale, Fantasma e Bauletto.

BI-WOOD

The Bi-Wood slatted base is made of a sprung wooden structure with a fixed sleeping platform, featuring a frame and laminated beechwood slats with firmness regulators and sprung lateral supports. The Bi-Wood slatted base is compatible with the Traditional, Fantasma and Bauletto bases.



BI-WIRELESS

Progettata per offrire il massimo comfort, la rete Bi-Wireless consente la regolazione indipendente delle diverse zone del corpo, migliorando relax e benessere in ogni momento della giornata. Rete in legno balancelle con telecomando Bluetooth e motore a scomparsa, realizzata con doghe in multistrato di faggio. Compatibile con le Basi Tradizionale, Fantasma e Bauletto.

BI-WIRELESS

Designed to offer the highest level of comfort, the Bi-Wireless slatted base allows independent adjustment of different body zones, enhancing relaxation and well-being at any time of day. It features a sprung wooden structure, Bluetooth remote control and a concealed motor, and is made with laminated beechwood slats. Compatible with the Traditional, Fantasma and Bauletto bases.

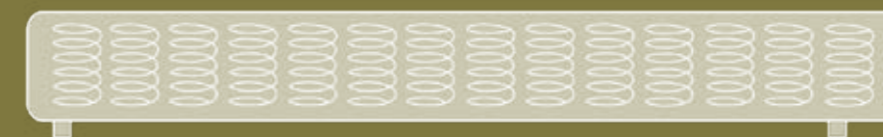

SOMMIER A INCASSO

Il piano di riposo con sommier a incasso è realizzato con due sommier a molle insacchettate inseriti all'interno della base e progettati per creare un piano di riposo con un sostegno puntuale e differenziato favorendo una corretta distribuzione del peso corporeo e un' elevata capacità di assorbimento delle sollecitazioni.

RECESSED SOMMIER

The sleeping platform with recessed sommier is made up of two pocket-spring sommier housed inside the base and designed to create a sleeping surface with targeted, differentiated support. This solution promotes proper body weight distribution and offers a high capacity for absorbing stress and pressure.



SOMMIER A FILO

Il piano di riposo con sommier a filo a molle insacchettate indipendenti è progettato per accogliere il materasso direttamente in appoggio sulla base, senza incassarlo all'interno del giroletto, ottimizzando così gli ingombri del letto e offrendo al contempo un sostegno ergonomico puntuale e un comfort superiore, per garantire un riposo di alta qualità.

FLUSH SOMMIER

The sleeping platform with flush sommier and independent pocket springs is designed to support the mattress directly on the base, without recessing it into the bed frame. This optimises the overall dimensions of the bed while providing precise ergonomic support and enhanced comfort, ensuring a high-quality sleep experience.

Basi

Bases

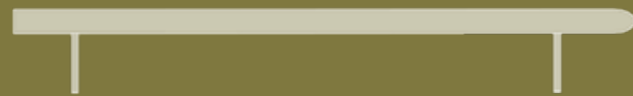

BASE VELA

La base letto dal design sottile unisce solidità e leggerezza visiva, conferendo al letto un carattere elegante e moderno. La silhouette essenziale crea un effetto di sospensione che valorizza ogni dettaglio del materasso e della testiera, rendendo la camera più ariosa, contemporanea e dall'atmosfera curata, senza appesantire lo spazio.

BASE VELA®

The bed base features a slim design that combines solidity with visual lightness, giving the bed an elegant and contemporary character. Its essential silhouette creates a floating effect that enhances every detail of the mattress and headboard, making the bedroom feel more airy, modern and refined, without weighing down the space.

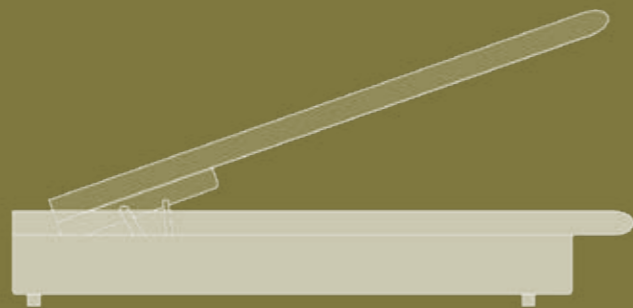

BASE FANTASMA

Purezza formale e sensazione di sospensione. La Base Fantasma nasce da una struttura innovativa che unisce stabilità e leggerezza visiva, in un equilibrio armonico tra architettura e comfort. La sua essenzialità mette in risalto il materasso, trasformandolo nel vero protagonista della zona notte.

BASE FANTASMA

Formal purity and a sense of suspension. Base Fantasma is built on an innovative structure that combines stability and visual lightness, achieving a harmonious balance between architecture and comfort. Its minimalist design highlights the mattress, turning it into the true focal point of the sleeping area.

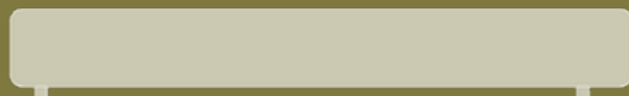

BASE TRADIZIONALE

La Base Tradizionale è predisposta per l'alloggiamento del piano di riposo Bi-Wood utilizzato come configurazione standard. In alternativa per esigenze di maggior incasso del materasso all'interno della base è possibile inserire come piano di riposo una rete 14 doghe e regolatori di rigidità con telaio in acciaio.

BASE TRADIZIONALE

Base Tradizionale is designed to accommodate the Bi-Wood sleeping platform, which is used as the standard configuration. Alternatively, for a deeper mattress recess within the base, it is possible to fit a 14-slat frame with firmness regulators and a steel frame as the sleeping platform.



BASE BAULETTO®

La praticità incontra l'eleganza formale. La base Bauletto è dotata di un solido meccanismo di sollevamento che rivela un capiente vano contenitore, mantenendo intatta la raffinatezza delle proporzioni e la solidità costruttiva. Una soluzione pensata per chi cerca ordine e funzionalità senza compromessi estetici.

BASE BAULETTO®

Practicality meets formal elegance. Base Bauletto features a solid lifting mechanism that reveals a spacious storage compartment, while preserving refined proportions and structural solidity. A solution designed for those seeking order and functionality without compromising on aesthetics.



BASE SOMMIER A INCASSO

La base sommier a incasso è realizzata con due sommier a molle insacchettate progettati per creare un piano di riposo con un sostegno puntuale e differenziato favorendo una corretta distribuzione del peso corporeo e un'elevata capacità di assorbimento delle sollecitazioni.

RECESSED SOMMIER BASE

The recessed sommier base is made up of two pocket-spring sommier, designed to create a sleeping surface with targeted, differentiated support. This solution promotes proper body weight distribution and offers a high capacity for absorbing stress and pressure.



BASE SOMMIER A FILO

La base sommier a filo con molle insacchettate indipendenti è progettata per accogliere il materasso direttamente in appoggio sulla base, senza incassarlo all'interno del giroletto, ottimizzando così gli ingombri del letto e offrendo al contempo un sostegno ergonomico.

FLUSH SOMMIER BASE

The flush sommier base, with independent pocket springs, is designed to support the mattress directly on the base, without recessing it into the bed frame. This optimises the overall dimensions of the bed while providing precise ergonomic support and enhanced comfort.

Testiere

Headboards



ALBA LONG

Linee morbide e proporzioni generose definiscono Alba Long, una testiera dal carattere accogliente e sofisticato. La sua presenza equilibrata, essenziale e contemporanea conferisce all'ambiente notte un'atmosfera rilassata e raffinata.

ALBA LONG

Soft lines and generous proportions define Alba Long, a headboard with a welcoming and sophisticated character. Its balanced, essential and contemporary presence brings a relaxed yet refined atmosphere to the bedroom.

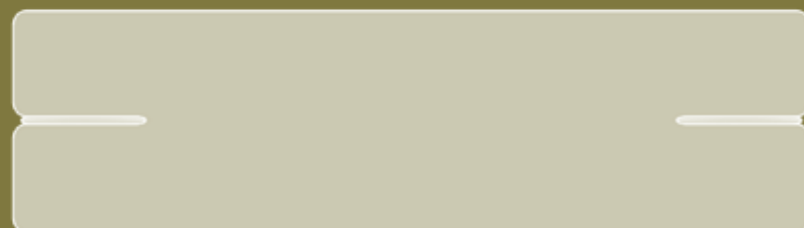

ALBA VOLER

Un segno grafico semplice e deciso che esprime leggerezza e modernità. Alba Voler è una testiera dalle forme snelle, pensata per chi cerca un dettaglio essenziale capace di dialogare con qualsiasi base, mantenendo eleganza e armonia.

ALBA VOLER

A simple, decisive graphic gesture that expresses lightness and modernity. Alba Voler is a headboard with slender forms, designed for those seeking an essential detail capable of pairing with any base while maintaining elegance and harmony.

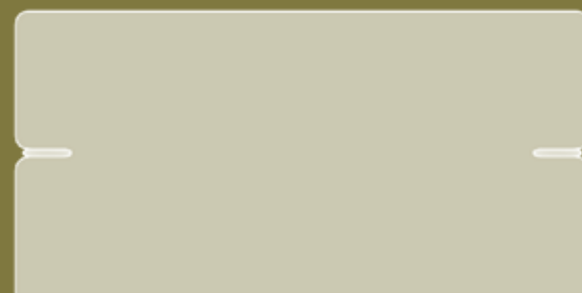

ALBA MOYEN

Un equilibrio di proporzioni e volumi che dona alla zona notte una raffinata sobrietà. Alba Moyen interpreta la testiera come un elemento architettonico discreto in grado di accogliere senza mai sovrastare, con un linguaggio di design puro e senza tempo.

ALBA MOYEN

A harmonious balance of proportions and volumes lends the bedroom a refined sense of understated elegance. Alba Moyen interprets the headboard as a discreet architectural element, designed to welcome without ever overpowering, expressed through a pure and timeless design language.

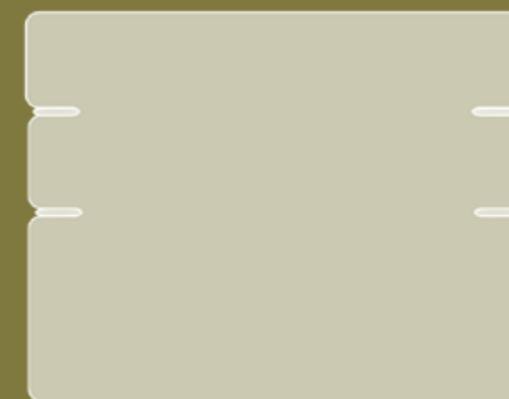

ALBA HAUTE

Elegante e scenografica, Alba Haute ridisegna lo spazio con proporzioni verticali. Un segno architettonico che coniuga rigore ed eleganza. Testiera alta e elegantemente rifinita, capace di dare carattere a ogni ambiente notte e rendere il tuo letto il vero protagonista.

ALBA HAUTE

Elegant and scenographic, Alba Haute reshapes the space through vertical proportions. An architectural statement that combines rigour and elegance. A tall, finely finished headboard that adds character to any bedroom, making the bed the true focal point.

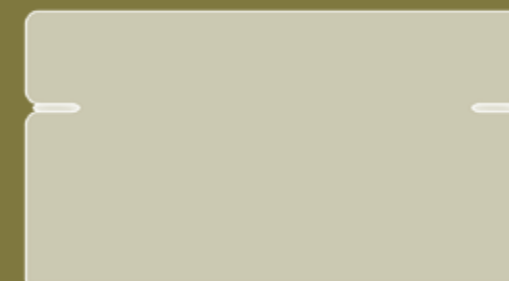

ALBA PETIT

Linee raccolte e morbide, pensate per spazi intimi e raffinati. Alba Petit unisce semplicità ed eleganza, trasformando la discrezione in lusso autentico. Una testiera che regala armonia e comfort anche nelle proporzioni più contenute.

ALBA PETIT

Compact, soft lines designed for intimate and refined spaces. Alba Petit combines simplicity and elegance, transforming discretion into authentic luxury. A headboard that brings harmony and comfort even in more compact proportions.

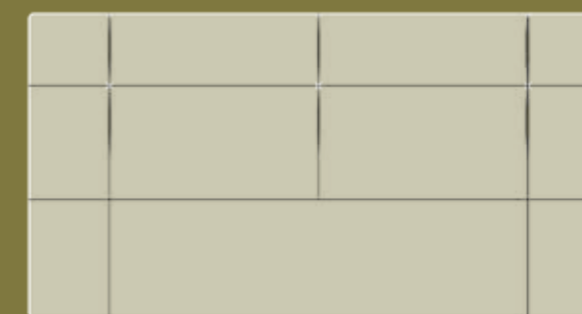

MONFORTE

Un disegno modulare scandito da riquadri geometrici. Monforte esprime rigore formale e contemporaneità, trasformando la testiera in un segno architettonico deciso. Ideale per ambienti dal carattere forte, dove eleganza e design convivono con naturalezza.

MONFORTE

A modular design defined by geometric panels. Monforte expresses formal rigour and contemporaneity, turning the headboard into a strong architectural feature. Ideal for interiors with a bold character, where elegance and design coexist naturally.



RODDI

Un carattere sartoriale che si rivela nei dettagli decorativi. La testiera Roddi si distingue per le raffinate lavorazioni, che trasformano il letto in un elemento prezioso e ricercato. Perfetta per ambienti che esigono personalità e unicità.

RODDI

A tailored character revealed through decorative details. The Roddi headboard stands out for its refined workmanship, transforming the bed into a precious and distinctive element. Perfect for interiors that demand personality and uniqueness.



ROERO

Linee morbide e un profilo superiore dolcemente sagomato conferiscono a Roero un'eleganza classica rivisitata in chiave contemporanea. Una testiera che porta con sé il fascino della tradizione artigianale, arricchendo l'ambiente notte con equilibrio e sobrietà.

ROERO

Soft lines and a gently shaped upper profile give Roero a classic elegance reinterpreted in a contemporary key. A headboard that carries the charm of artisanal tradition, enriching the bedroom with balance and restraint.



BARBARESCO

Un disegno sartoriale impreziosito da cuciture decorative che ne sottolineano la morbidezza. Barbaresco racconta la cura artigianale di Altrenotti e dona alla zona notte un carattere distintivo, elegante e sofisticato.

BARBARESCO

A tailored design enhanced by decorative stitching that emphasises its softness. Barbaresco reflects Altrenotti's artisanal care and gives the sleeping area a distinctive, elegant and sophisticated character.

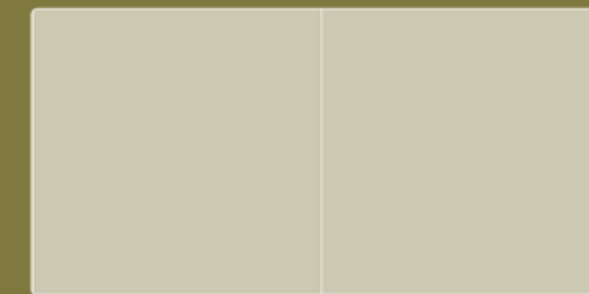

LA MORRA

Una forma essenziale, definita da due volumi accostati, per una testiera dal linguaggio semplice e raffinato. La Morra esprime purezza visiva e sobrietà, ideale per interni moderni che ricercano discrezione ed equilibrio.

LA MORRA

An essential form defined by two juxtaposed volumes, creating a headboard with a simple yet refined language. La Morra expresses visual purity and sobriety, ideal for modern interiors that seek discretion and balance.



NEIVE

Linee nette e rigorose delineano una testiera minimale che valorizza la pulizia del disegno. Neive è la scelta ideale per chi desidera un design contemporaneo e senza fronzoli, capace di inserirsi con eleganza in qualsiasi progetto.

NEIVE

Clean, rigorous lines define a minimalist headboard that highlights the purity of its design. Neive is the ideal choice for those seeking a contemporary, understated aesthetic that integrates elegantly into any interior project.



LILY

Un profilo dolce e delicato, che ammorbidisce l'ambiente notte con una presenza sobria e femminile. Lily interpreta la testiera come dettaglio decorativo, pensato per atmosfere intime e accoglienti.

LILY

A soft, delicate profile that gently enhances the bedroom with a subtle, feminine presence. Lily interprets the headboard as a decorative detail, designed for intimate and welcoming atmospheres.

L'arte segreta del risveglio sereno

The secret art of waking up serene



Le collezioni biancheria di Altrenotti nascono con lo stesso spirito con cui vengono creati letti e materassi: donare benessere alla persona. Colori avvolgenti, morbide texture e dettagli pensati per offrire un comfort assoluto e un'eleganza senza tempo.

COLLEZIONE CAREZZA

Realizzata in raso di cotone lavato, la collezione Carezza unisce morbidezza, praticità e un look raffinato. Il suo nome richiama l'esperienza tattile unica che offre: una carezza di alta qualità, pensata per trasmettere eleganza e comfort in ogni dettaglio.

COLLEZIONE AIR WASH

Effetto no-stiro: il tessuto mantiene un aspetto ordinato e morbido senza necessità di stiratura. Mano morbida e setosa: il trattamento dona una piacevole sensazione al tatto. Aspetto naturalmente elegante: finitura leggermente "vaporosa" e sofisticata.

COLLEZIONE SATIN JACQUARD

Biancheria da letto confezionata con tessuto jacquard in armatura satin, espressione di un lusso che unisce brillantezza e morbidezza a una decorazione sofisticata, tessuta direttamente nei filati e non stampata. Un materiale pregiato, elegante e dalla struttura tridimensionale.

COLLEZIONE SATIN UNITO

Realizzata in raso di cotone lavato e mercerizzato. Il satin unito rappresenta l'incontro perfetto tra raffinatezza e comfort offrendo una brillantezza naturale e una morbidezza che dura nel tempo.

COLLEZIONE LINO

Realizzata esclusivamente con fibre di lino pregiate, questa biancheria unisce resistenza naturale, traspirabilità e un'eleganza senza tempo. Il lino offre una straordinaria capacità di regolare la temperatura corporea, mantenendo freschezza in estate e comfort in inverno.

COLLEZIONE TEXTURE

Collezione di Biancheria in raso stampato caratterizzata da una lucentezza sofisticata e da una mano setosa. Disegni geometrici, motivi floreali perfettamente armonizzati nei mondi colore delle nostre collezioni di biancheria.

Altrenotti bed linen collections are created with the same philosophy that inspires the design of its beds and mattresses: to bring wellbeing to the individual. Enveloping colours, soft textures and carefully considered details come together to offer absolute comfort and timeless elegance.

CAREZZA COLLECTION

Made from washed cotton sateen, the Carezza Collection combines softness, practicality and a refined aesthetic. Its name evokes the unique tactile experience it offers: a high-quality caress, designed to convey elegance and comfort in every detail.

AIR WASH COLLECTION

Easy-care, no-iron effect: the fabric maintains a neat, soft appearance without the need for ironing. Soft, silky hand feel: the special treatment provides a pleasant tactile sensation. Naturally elegant look: a slightly airy, sophisticated finish.

SATIN JACQUARD COLLECTION

Bed linen crafted from jacquard fabric with a satin weave, expressing a form of luxury that combines brilliance and softness with sophisticated decoration. The pattern is woven directly into the yarns rather than printed, resulting in a refined, elegant material with a distinctive three-dimensional structure.

SATIN UNITO COLLECTION

Made from washed and mercerised cotton sateen. Satin Unito represents the perfect balance between refinement and comfort, offering natural lustre and long-lasting softness.

LINEN COLLECTION

Crafted exclusively from premium linen fibres, this bed linen combines natural durability, breathability and timeless elegance. Linen offers an exceptional ability to regulate body temperature, ensuring freshness in summer and comfort in winter.

TEXTURE COLLECTION

A bed linen collection in printed sateen, characterised by a sophisticated sheen and a silky hand feel. Geometric designs and floral motifs are perfectly harmonised with the colour palettes of our bed linen collections.



sleep systems
sistemi di riposo

ALBA LONG

BASE BAULETTO®

“Il mattino ha in sé qualcosa di sacro, quando ogni cosa sembra possibile” scriveva Pavese.

Alba Long traduce questa sensazione in architettura del riposo: una testiera dalle ampie proporzioni diventa quinta scenografica, arricchita da mensole rivestite in pelle o in legno con diverse finiture noce canaletto, wengé o nero che custodiscono gesti quotidiani con naturalezza. La Base Bauletto cela un vano contenitore ampio e funzionale, integrato in un disegno puro e rigoroso. Un letto che interpreta la tradizione artigiana con grazia contemporanea, trasformando la notte in rito di eleganza.

“Morning has something sacred within it, when everything seems possible” wrote Pavese.

Alba Long translates this feeling into an architecture of rest: a generously proportioned headboard becomes a scenic backdrop, enhanced by shelves upholstered in leather or wood, available in various finishes—Canaletto walnut, wengé or black—designed to hold everyday gestures with natural ease. The Base Bauletto conceals a spacious and functional storage compartment, seamlessly integrated into a pure, rigorous design. A bed that interprets artisanal tradition with contemporary grace, transforming the night into a ritual of elegance.





Letto: Alba Long
Tessuto di rivestimento:
collezione Contemporary - Tresigallo 01
Mensola: rivestita in pelle Mousse 2310
Poltrona: Alba Bergère tessuto di rivestimento
collezione Color World - Genziana 01



eucalipto



ceramica



Blancheria: collezione Carezza - Albero
Federe: collezione Air Wash
- Oliva con piping Cielo
Plaid: collezione Lino Anversa - Avorio





ALBA LONG

BASE FANTASMA

Alba Long con Base Fantasma esalta l'impatto visivo della testiera, diventando protagonista assoluto della stanza. Le linee alte e proporzionate amplificano l'effetto scenografico, mentre la Base Fantasma dona equilibrio e leggerezza. Un progetto che interpreta il riposo come esperienza di eleganza e imponenza. Il tessuto, selezionato con cura, intensifica la percezione materica. Come scriveva Guido Gozzano: *"Non amo che le rose che non colsi."* Alba Long racchiude questa nostalgia in una presenza solida e poetica.

Alba Long with Base Fantasma enhances the visual impact of the headboard, making it the absolute focal point of the room. Its tall, well-balanced lines amplify the scenographic effect, while the Fantasma base adds balance and visual lightness. A project that interprets rest as an experience of elegance and presence. The carefully selected fabric intensifies the tactile perception. As Guido Gozzano wrote: *"I only love the roses I did not gather."* Alba Long encapsulates this sense of nostalgia in a solid yet poetic presence.



Letto: Alba Long
Tessuto di rivestimento:
collezione Elite - Funky 52
Poltrona: Alba Bergère tessuto di rivestimento
collezione Color World - Genziana 01
Inserti: massello Noce Canaletto



#intonaco



#tabacco

Biancheria: collezione Air Wash
- Panna con piping Oliva
Cuscini arredo 50x30: rivestimento
collezione Elite - Funky 52
Plaid: collezione Vitale Barberis Canonico
- Unito Beige



custom e eleganza

custom and utility

La testiera Alba Long definisce il carattere del letto sviluppandosi con eleganza e trasformandosi in un elemento architettonico che domina la stanza.

La testiera Alba Long con eleganti inserti in noce canaletto è progettata per essere ulteriormente personalizzabile arricchendola con mensole e prese elettriche integrate trasformando il letto in una soluzione completa che unisce design, comfort e funzionalità quotidiana.

The Alba Long headboard defines the character of the bed, unfolding with elegance and transforming into an architectural element that dominates the space.

The Alba Long headboard, featuring refined Canaletto walnut inserts, is designed to be further customised with shelves and integrated electrical outlets, turning the bed into a complete solution that brings together design, comfort and everyday functionality.





ALBA MOYEN

BASE SOMMIER A FILO

Alba Moyen con Base Sommier a filo unisce sobrietà formale e raffinatezza materica. La testiera Alba Moyen, dalle proporzioni equilibrate, dialoga con la Base Sommier a filo in un volume compatto e rigoroso, concepito per esaltare la centralità del materasso. Il rivestimento in tessuto Vitale Barberis Canonico, storica eccellenza laniera fondata nel 1663, porta con sé l'eredità della tradizione sartoriale italiana. Un letto che intreccia rigore architettonico e cultura del tessile, trasformando la notte in un'esperienza di eleganza autentica.

Alba Moyen with Flush Sommier Base combines formal sobriety with material refinement. The Alba Moyen headboard, with its balanced proportions, interacts with the flush sommier base in a compact, rigorous volume, conceived to enhance the centrality of the mattress. The upholstery in Vitale Barberis Canonico fabric—an historic woollen excellence founded in 1663—carries with it the heritage of Italian tailoring tradition. A bed that weaves together architectural rigour and textile culture, transforming the night into an experience of authentic elegance.





sinergie di eccellenze

synergies of excellence

La scelta del tessuto di rivestimento definisce non solo lo stile e il carattere del letto, ma ne conferisce un'identità esclusiva, trasformandolo nel vero protagonista della camera da letto. Altrenotti veste i suoi letti con le pregiate flanelle cardate di Vitale Barberis Canonico, proponendo una palette che spazia dalle tinte unite raffinate alle fantasie iconiche come Tartan e Principe di Galles. Questa sinergia nasce dalla costante ricerca di eccellenza nei materiali, unendo l'arte e la maestria artigianale di Altrenotti alla raffinatezza unica dei tessuti di Vitale Barberis Canonico, azienda italiana protagonista indiscussa del Made in Italy.

The choice of upholstery fabric defines not only the style and character of the bed, but also gives it a distinctive identity, turning it into the true focal point of the bedroom. Altrenotti dresses its beds in the fine carded flannels of Vitale Barberis Canonico, offering a palette that ranges from refined solid colours to iconic patterns such as Tartan and Prince of Wales. This synergy stems from a constant pursuit of excellence in materials, uniting Altrenotti's artisanal mastery with the unique refinement of Vitale Barberis Canonico, a leading Italian company and an undisputed symbol of Made in Italy.

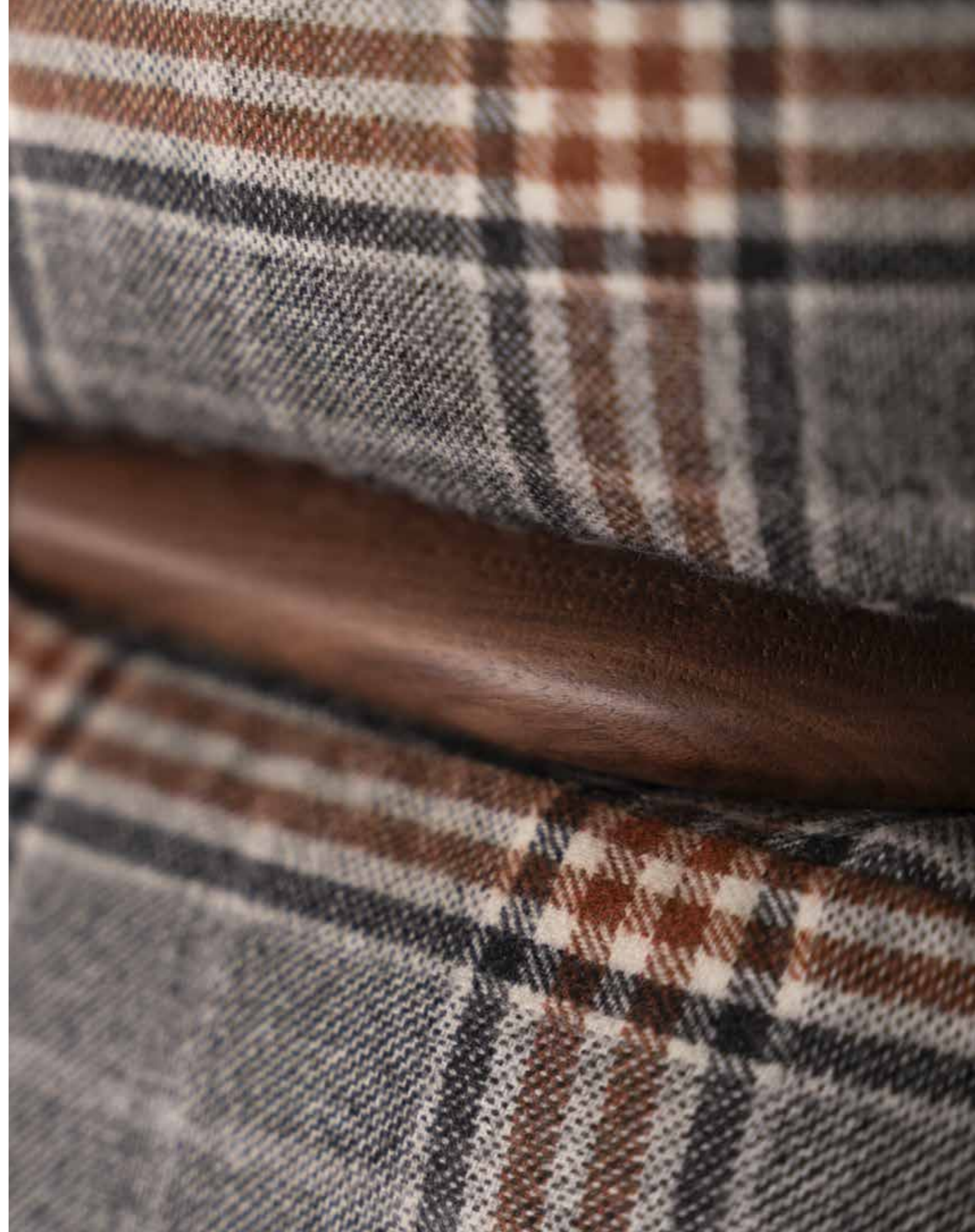



#cime maestose



Letto: Alba Moyen
Tessuto di rivestimento:
collezione Vitale Barberis Canonico
- Tartan Grigio-Beige
Inseriti: massello Noce Canaletto
Biancheria: collezione Air Wash
- Caffè con piping Cielo
Cuscini arredo 50x30: rivestimento
collezione Vitale Barberis Canonico
- Tartan Grigio-Beige
Plaid: collezione Vitale Barberis Canonico
- Unito Beige



eleganza e comfort

elegance and comfort

L'eleganza di un letto si esprime nelle sue proporzioni, nei tessuti di rivestimento e nei dettagli che arricchiscono la camera da letto con stile e personalità.

A questo si unisce la scelta di una Base Sommier a filo con molle insacchettate progettata per offrire un livello di comfort superiore, grazie a una struttura che lavora in perfetta sinergia con il materasso. Eleganza e comfort si uniscono in un binomio indissolubile, pensato per esaltare l'esperienza del riposo.

The elegance of a bed is expressed through its proportions, upholstery fabrics and the details that enrich the bedroom with style and personality.

This is complemented by the choice of a pocket-spring sommier base, designed to deliver a superior level of comfort thanks to a structure that works in perfect synergy with the mattress. Elegance and comfort merge into an inseparable pairing, created to enhance the sleeping experience.

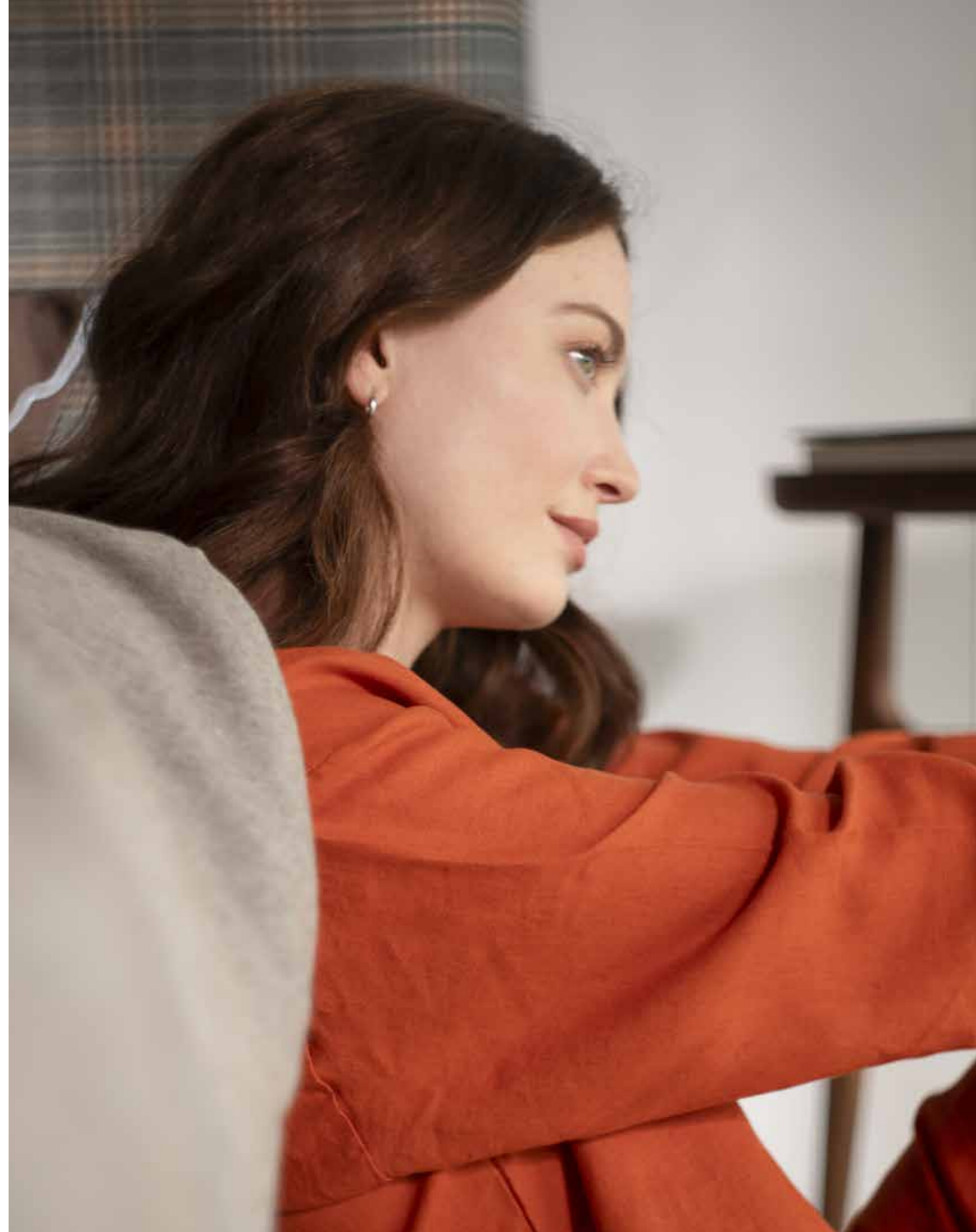



ALBA VOLER

BASE VELA

Alba Voler con Base Vela sembra sospeso nell'aria, un segno essenziale che unisce leggerezza e solidità. La testiera accogliente avvolge lo sguardo, mentre il rivestimento tessile trasmette calore e contemporaneità. È un letto pensato per chi cerca equilibrio tra estetica e funzione, ideale per ambienti luminosi e raffinati. Come scrisse Giovanni Arpino: *“La bellezza è un lampo che illumina la vita.”*

Alba Voler porta quella luce discreta e durevole negli spazi domestici.

Alba Voler with Base Vela appears to float in the air—an essential form that combines lightness and solidity.

The welcoming headboard gently frames the gaze, while the textile upholstery conveys warmth and contemporary character. A bed designed for those seeking balance between aesthetics and function, ideal for bright and refined interiors. As Giovanni Arpino wrote: *“Beauty is a flash that lights up life.”*

Alba Voler brings that discreet, enduring light into domestic spaces.



Letto: Alba Voler
Tessuto di rivestimento:
collezione Vitale Barberis Canonico
- Principe di Galles Nero
Piede: Stilobate
Tavolino: Tratto massello Frassino Nero
Inserti: massello Noce Canaletto



perla dorata



cenere di basalto



*Biancheria: collezione Satin Unito - Ostrica
Cuscini arredo 50x30: rivestimento
collezione Vitale Barberis Canonico
- Principe di Galles Nero
Plaid: collezione Vitale Barberis Canonico
- Pied de Poule Nero*

stile da gentleman

gentleman style

Raffinato e intramontabile il letto Alba Voler rivestito in flanella cardata di Vitale Barberis Canonico fantasia Principe di Galles regala alla camera da letto un'eleganza classica reinterpretata in chiave contemporanea. Sobrietà, classe e cura del dettaglio: l'essenza dello stile da gentleman.

Refined and timeless, the Alba Voler bed upholstered in carded flannel by Vitale Barberis Canonico with a Prince of Wales pattern lends the bedroom a classic elegance reinterpreted in a contemporary key. Sobriety, class and attention to detail: the essence of gentleman style.





ALBA VOLER

BASE VELA

Alba Voler con Base Vela aggiunge funzionalità alla leggerezza: una struttura raffinata che può essere integrata con utilizzo di mensole rivestite in pelle oppure in legno con diverse finiture.

La testiera slanciata dialoga con la base sospesa, creando armonia tra estetica e praticità. È un'architettura domestica sottile e accogliente. Come scrisse Cesare Pavese: *"Un paese vuol dire non essere soli."* Alba Voler diventa questo luogo intimo, capace di unire bellezza e necessità in un gesto elegante.

Alba Voler with Base Vela adds functionality to lightness: a refined structure that can be integrated with shelves upholstered in leather or in wood, available in various finishes.

The slender headboard interacts with the suspended base, creating harmony between aesthetics and practicality. A subtle and welcoming form of domestic architecture. As Cesare Pavese wrote: *"A place means not being alone."* Alba Voler becomes this intimate place, capable of uniting beauty and necessity in an elegant gesture.





tocco di classe

a touch of class

La testiera Alba Voler può essere arricchita con mensole integrate, disponibili in finitura in pelle o in legno noce canaletto, in frassino finitura nero oppure wengé. Una soluzione che unisce funzionalità ed estetica: l'aggiunta delle mensole valorizza la struttura e dona al letto un indiscusso tocco di classe, rendendo l'ambiente notte ancora più raffinato ed esclusivo.

The Alba Voler headboard can be enhanced with integrated shelves, available in leather or wood finishes such as Canaletto walnut, black-stained ash, or wengé. A solution that brings together functionality and aesthetics: the addition of shelves enhances the structure and gives the bed an unmistakable touch of class, making the bedroom even more refined and exclusive.

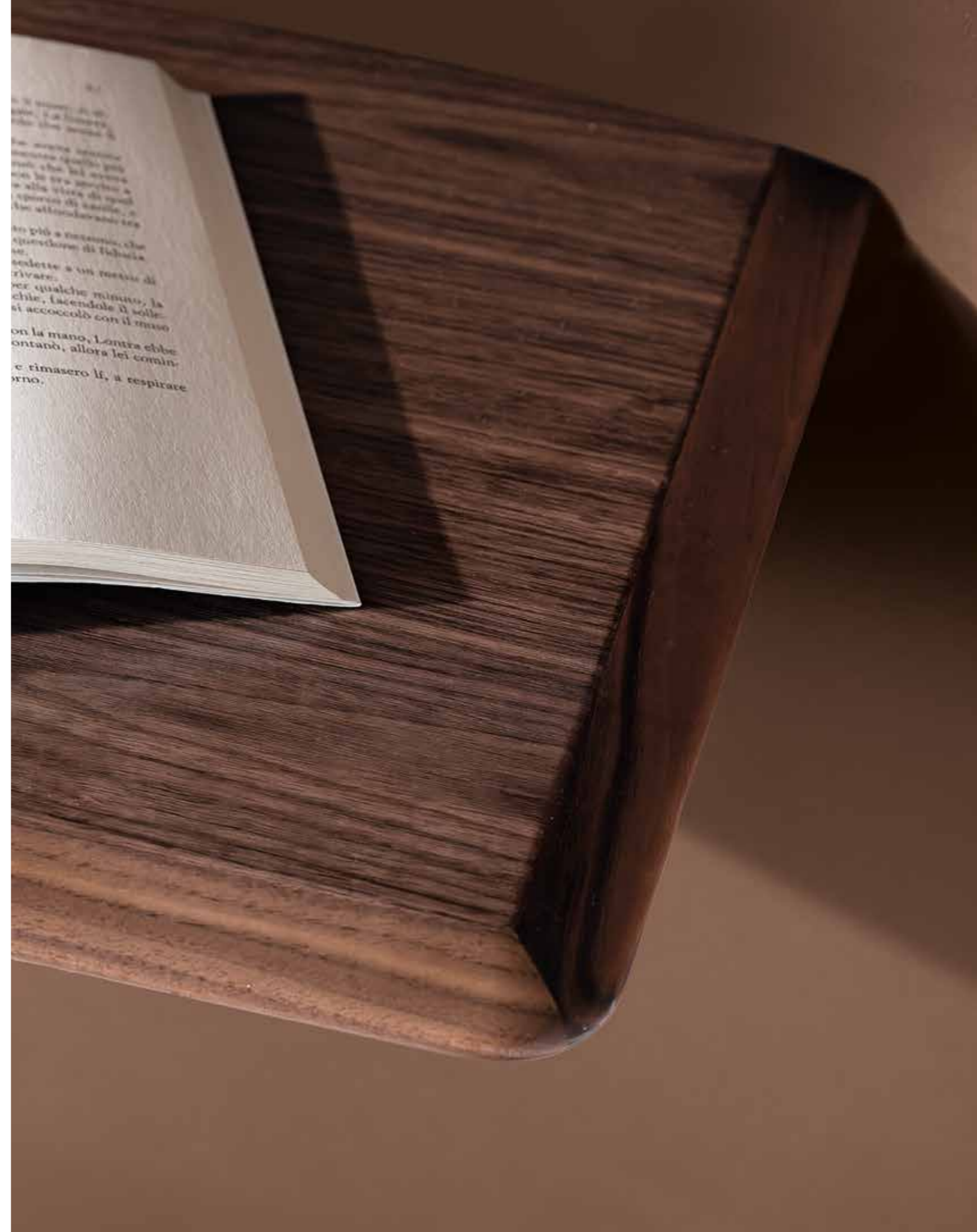

rosso ruggine





Letto: Alba Voler
Rivestimento in pelle: collezione
- Luna 1137
Mensola: massello Noce Canaletto
Piede: Stilobate
Biancheria: collezione Satin Unito - Ostrica
Federe: collezione Carezza - Damar
Plaid: collezione Nube Cipria

savoir faire sartoriale

tailored savoir-faire

Un letto che racconta il savoir faire sartoriale attraverso dettagli precisi, finiture curate e una scelta di materiali che richiama l'eleganza delle migliori lavorazioni artigianali.

Un design raffinato che trasforma il riposo in un'esperienza di stile.

A bed that expresses tailored savoir-faire through precise details, carefully crafted finishes and a selection of materials that recalls the elegance of the finest artisanal workmanship.

A refined design that transforms rest into an experience of style.

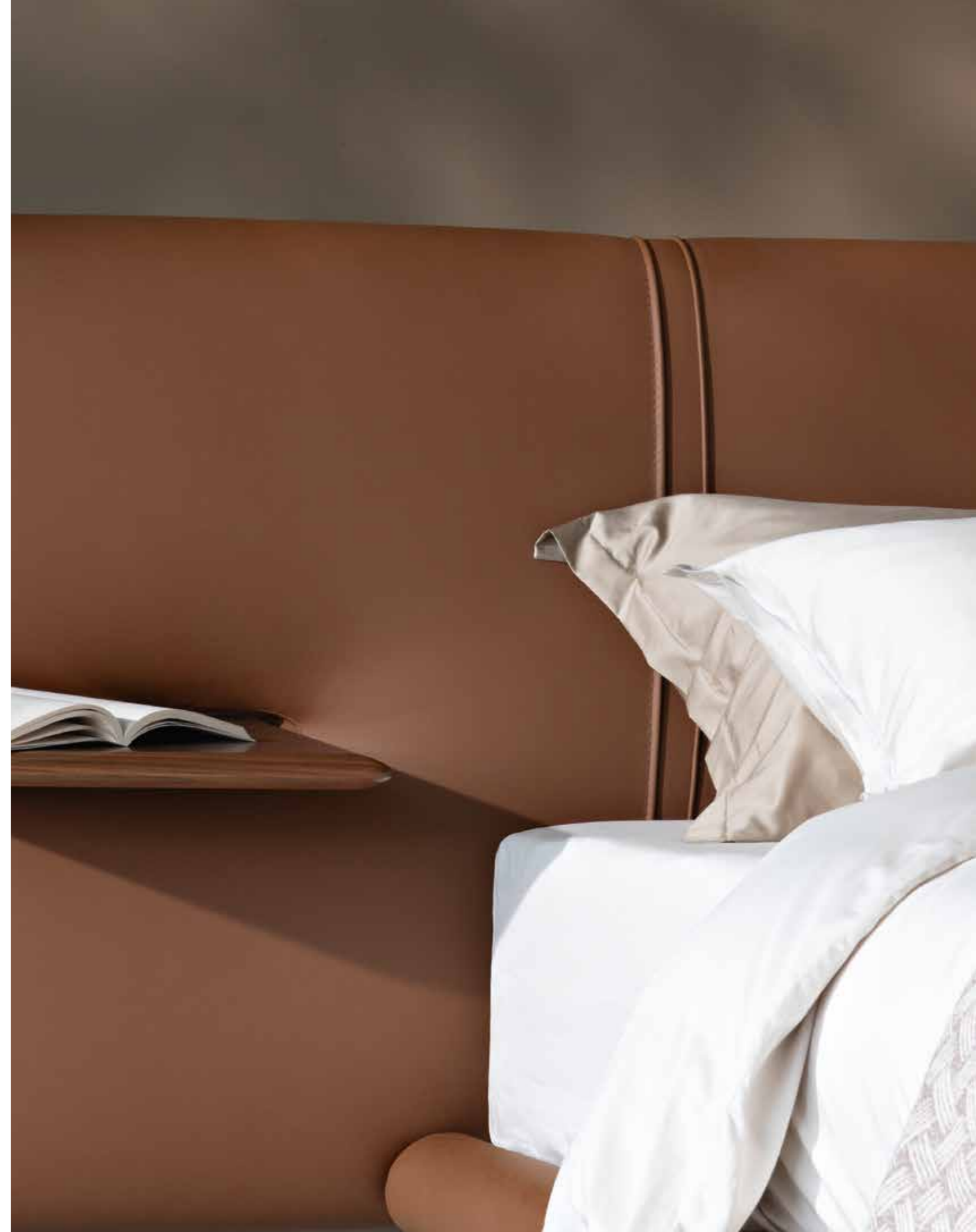



ALBA HAUTE

BASE BAULETTO®

Alba Haute con Base Bauletto è una dichiarazione di eleganza: la testiera alta e maestosa definisce lo spazio con autorità, mentre la base racchiude la praticità dell'ordine. Il rivestimento, morbido e materico, amplifica la sensazione di comfort. È un letto che unisce imponenza e funzionalità, perfetto per interni sofisticati. Come scriveva Davide Lajolo: *“La natura insegna equilibrio e misura.”* Alba Haute incarna questa lezione, fondendo bellezza e proporzione in un'unica visione.

Alba Haute with Base Bauletto is a statement of elegance: the tall, majestic headboard defines the space with authority, while the base conceals the practicality of order. The upholstery, soft and richly textured, enhances the sensation of comfort. A bed that combines presence and functionality, perfect for sophisticated interiors.

As Davide Lajolo wrote: *“Nature teaches balance and measure.”* Alba Haute embodies this lesson, blending beauty and proportion into a single vision.

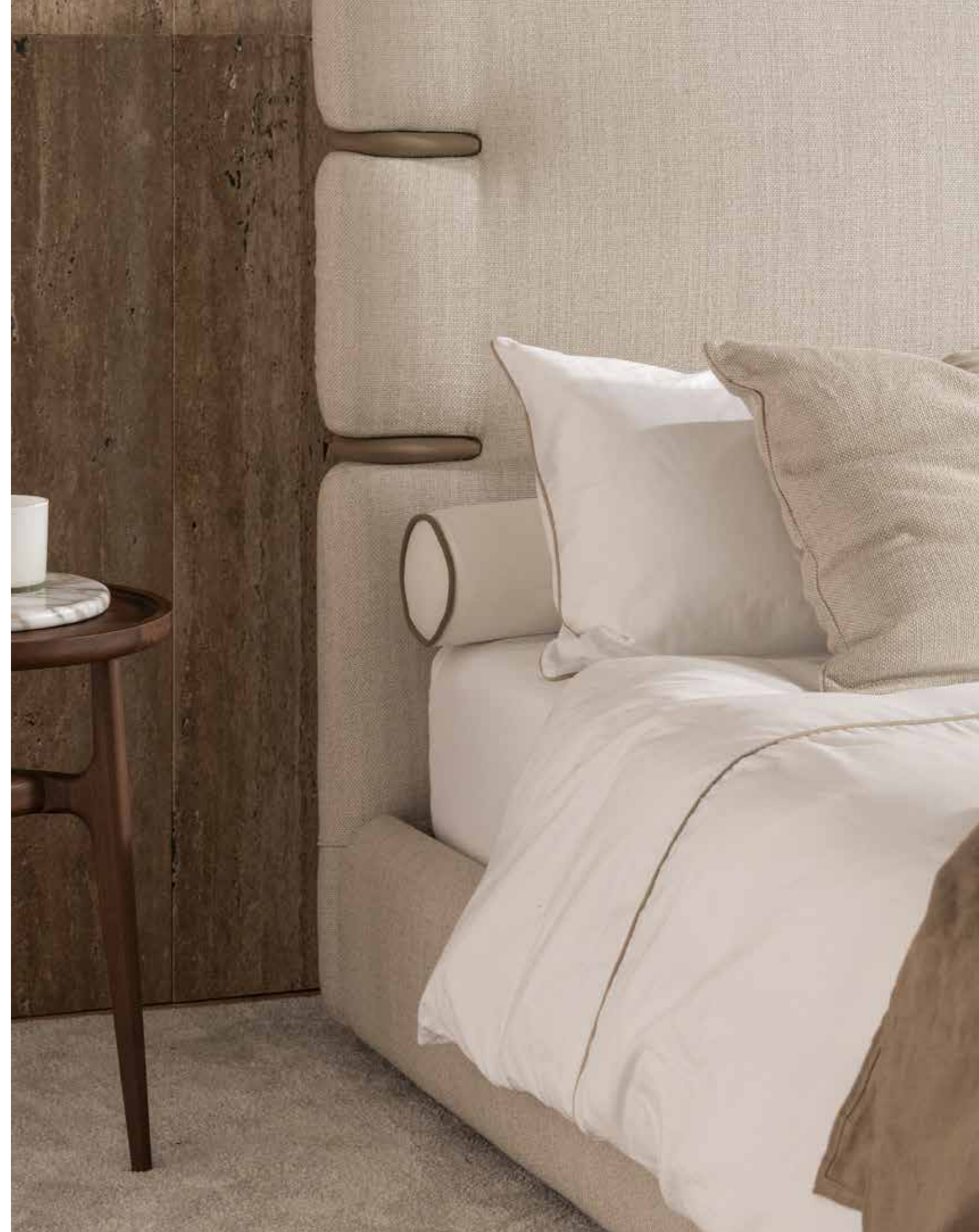

Letto: Alba Haute
Tessuto di rivestimento: collezione Elite
- Taiga 02/1
Tavolino: Giunto massello Noce Canaletto
Inserti: rivestiti in pelle Mousse 2322





caffè latte

vanilla

Biancheria: collezione Air Wash
- Bianco Ottico con piping beige
Plaid: Collezione Lino Anversa Wafer
Cuscini arredo 50x50:
rivestimento collezione Elite
- Taiga 02/1





altezza di stile

height of style

Con la sua testiera alta e generosamente imbottita Alba Haute diventa il vero protagonista dell'ambiente. Le sue linee morbide e precise offrono un'immediata sensazione di comfort mentre l'altezza della testiera dona eleganza scenografica. L'armonia dei colori beige, bianco e tortora crea un ambiente intimo, luminoso e rilassante.

With its tall, generously padded headboard, Alba Haute becomes the true focal point of the room. Its soft yet precise lines offer an immediate sense of comfort, while the height of the headboard lends a striking, scenographic elegance. The harmony of beige, white and dove-grey tones creates an intimate, bright and relaxing atmosphere.





ALBA PETIT

BASE VELA

Alba Petit con Base Vela interpreta la delicatezza. Le proporzioni contenute e armoniche rendono il letto perfetto per spazi più intimi, senza rinunciare a design e comfort. La Base Vela dona leggerezza visiva, mentre la testiera sobria e morbida amplifica la sensazione di accoglienza. È un invito alla quiete quotidiana. Come scrisse Massimo Mila: *“La semplicità è il segreto della bellezza.”* Alba Petit lo conferma, offrendo un rifugio che parla di purezza ed equilibrio.

Alba Petit with Base Vela interprets delicacy. Its compact, harmonious proportions make the bed ideal for more intimate spaces, without sacrificing design or comfort. The Vela base provides visual lightness, while the sober, softly padded headboard enhances the feeling of welcome. An invitation to everyday calm. As Massimo Mila wrote: *“Simplicity is the secret of beauty.”* Alba Petit confirms this, offering a refuge that speaks of purity and balance.





Letto: Alba Petit
Tessuto di rivestimento: collezione Couture
- Gemma 27
Inserti: massello Noce Canaletto
Tavolino: Tratto massello Noce Canaletto





muschio

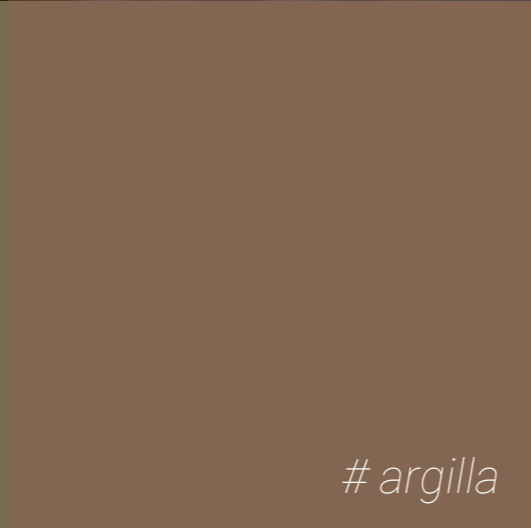

argilla



Biancheria: collezione Lino Brouges Wafer
Cuscini arredo 50x30: rivestimento
collezione Couture - Gemma 27
Plaid: collezione Lino Anversa Wafer



sospeso con stile

suspended in style

La Base Vela sottile e visivamente sospesa dona al letto una straordinaria leggerezza estetica, il colore verde del rivestimento dell'Alba Petit e la biancheria in lino nella tonalità naturale donano calore e morbidezza esaltando il dialogo tra colori e materiali.

The slim, visually suspended Base Vela gives the bed an extraordinary sense of aesthetic lightness. The green upholstery of Alba Petit, paired with linen bed linen in a natural shade, adds warmth and softness, enhancing the dialogue between colours and materials.





MONFORTE

BASE BAULETTO®

Monforte rilegge il capitonné con un linguaggio sinuoso e moderno: le cuciture creano un ritmo elegante, conferendo al letto un aspetto contemporaneo. La Base Bauletto completa il progetto con funzionalità intelligente. È un letto che unisce tradizione sartoriale e design innovativo. Come scrisse Cesare Pavese *“la bellezza delle cose esiste nella mente che le contempla.”*

Monforte reinterprets capitonné through a sinuous, contemporary language: the stitching creates an elegant rhythm, giving the bed a modern appearance. The Base Bauletto completes the project with intelligent functionality. A bed that brings together tailored tradition and innovative design. As Cesare Pavese wrote: *“The beauty of things exists in the mind that contemplates them.”*





Letto: Monforte
Tessuto di rivestimento:
collezione Color World - Papavero 28
Tavolini: Tratto massello Noce Canaletto





cioccolato fondente



cachi



Biancheria: collezione Carezza - Aereo
Cuscini arredo 50x30: rivestimento
collezione Color World - Papavero 28
collezione Vitale Barberis Canonico
- Tartan Grigio-Beige
Plaid: collezione Vitale Barberis Canonico
- Tartan Grigio-Beige



ogni punto un capolavoro

every stitch a masterpiece

La testiera del letto Monforte si distingue per le sue eleganti cuciture verticali e orizzontali, realizzate con cura per conferire al letto un aspetto raffinato e contemporaneo. Sono tratti leggeri che accompagnano la morbidezza del tessuto e creano equilibrio naturale tra forma e comfort.

The Monforte headboard stands out for its refined vertical and horizontal stitching, meticulously crafted to give the bed a sophisticated, contemporary look. Light, graceful lines accompany the softness of the fabric, creating a natural balance between form and comfort.





RODDI

BASE BAULETTO®

Roddi celebra la materia e il dettaglio. La testiera capitonné, reinterpretata con tratti fluidi, veste i tessuti Vitale Barberis Canonico con un'eleganza attuale. La Base Bauletto racchiude la funzionalità senza appesantire l'insieme, mantenendo un equilibrio formale. È un letto che trasmette forza e continuità. Come ricordava Nuto Revelli: *“La memoria è un dovere.”* Roddi ne custodisce lo spirito, legando tradizione artigiana e innovazione con coerenza autentica.

Roddi celebrates materiality and detail. The capitonné headboard, reinterpreted with fluid lines, dresses Vitale Barberis Canonico fabrics with a modern elegance. The Base Bauletto encloses functionality without weighing down the overall design, preserving formal balance. A bed that conveys strength and continuity. As Nuto Revelli reminded us: *“Memory is a duty.”* Roddi safeguards this spirit, coherently linking artisanal tradition and innovation.



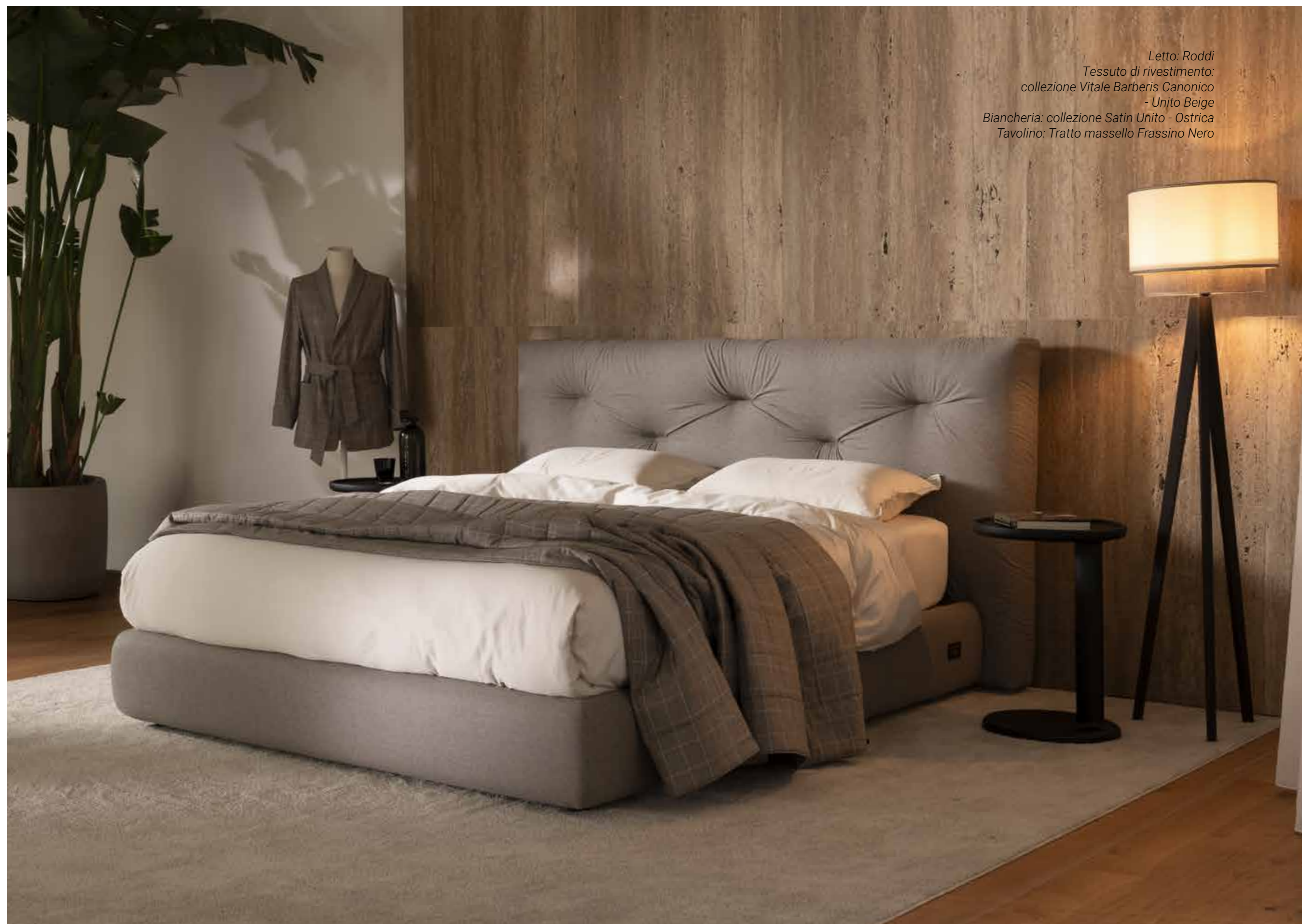

Letto: Roddi
Tessuto di rivestimento:
collezione Vitale Barberis Canonico
- Unito Beige
Biancheria: collezione Satin Unito - Ostrica
Tavolino: Tratto massello Frassino Nero



#taupe chiaro

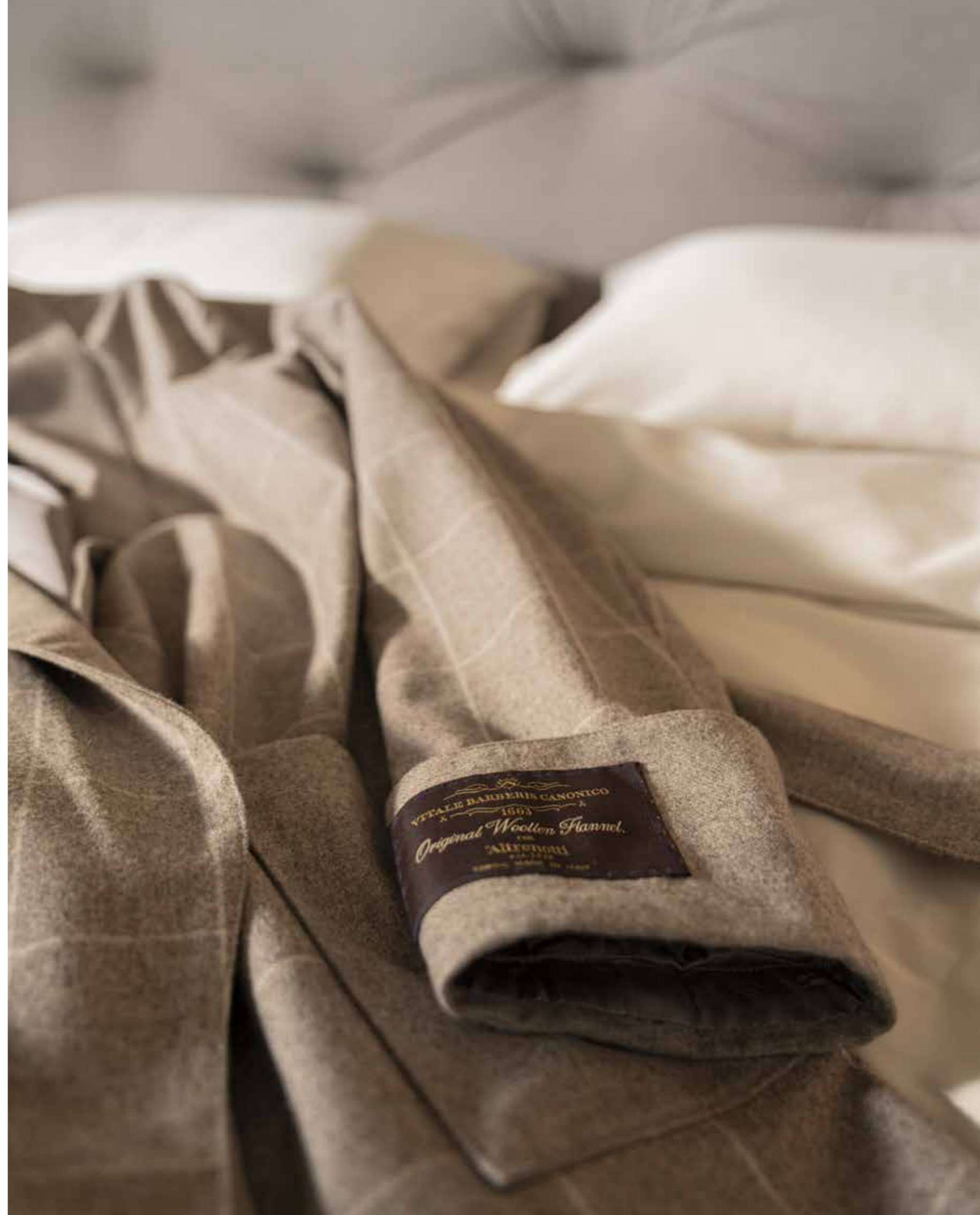



profonda raffinatezza

deep refinement

Roddi unisce forme morbide e un design essenziale, creando un ambiente notte caldo e accogliente.

La testiera impreziosita da lavorazioni sartoriali dona carattere e diventa un punto focale raffinato ma discreto. La base dalle linee morbide e contemporanee esprime solidità e comfort perfetto per chi desidera armonia e benessere nella zona notte.

Roddi combines soft forms with an essential design, creating a warm and welcoming sleeping environment.

The headboard, enhanced by tailored craftsmanship, adds character and becomes a refined yet discreet focal point. The base, with its soft, contemporary lines, expresses solidity and comfort—ideal for those seeking harmony and wellbeing in the bedroom.





BARBARESCO

BASE BAULETTO®

Barbaresco si distingue per la sua estetica morbida e avvolgente, caratterizzato da una testiera realizzata con due ampi cuscini imbottiti che offrono un supporto informale e confortevole. La base generosa e compatta segue lo stesso linguaggio di morbidezza integrandosi armoniosamente con la testiera. È un letto che parla di radici forti e contemporaneità. Come scrisse Beppe Fenoglio: *“Nelle Langhe non si racconta, si vive.”* Barbaresco incarna questa vita autentica, vibrante, profondamente legata al territorio e alle sue atmosfere.

Barbaresco stands out for its soft, enveloping aesthetic, defined by a headboard made of two generously padded cushions that offer an informal yet comfortable support. The generous, compact base follows the same language of softness, integrating harmoniously with the headboard. A bed that speaks of strong roots and contemporaneity. As Beppe Fenoglio wrote: *“In the Langhe, stories are not told—they are lived.”*

Barbaresco embodies this authentic, vibrant life, deeply connected to the land and its atmosphere.





*Letto: Barbaresco
Tessuto di rivestimento:
collezione Color World - Iris 80
Passamaneria: Titanio*

rugiada



ostrica



Biancheria: collezione Lino Brouges - Ostrica
Federe: collezione Air Wash
- Basalto con piping panna
Tavolino: Giunto massello Noce Canaletto
Poltrona: Alba Poltroncina tessuto di rivestimento
collezione Couture - Gemma 27





soffice eleganza

soft elegance

Barbaresco incarna un'eleganza che non ha bisogno di imporsi, è la morbidezza delle sue forme a definirne il carattere. Una soffice eleganza che accompagna il riposo e dona alla zona notte un tocco di stile discreto e indimenticabile.

Barbaresco embodies an elegance that does not need to assert itself; it is the softness of its forms that defines its character. A gentle elegance that accompanies rest and gives the bedroom a discreet yet unforgettable touch of style.





NEIVE

BASE VELA

Neive con Base Vela è un inno alla semplicità: linee sobrie, cuscini morbidi che accolgono, base sospesa che dona leggerezza. È un letto che coniuga autenticità e design, diventando isola di pace domestica. Pensato per chi ama la naturalezza, trasmette calma ed equilibrio. Come scrisse Mario Soldati: *“Il vero lusso è potersi permettere la semplicità.”* Neive esprime questa verità, trasformando il riposo in esperienza estetica e fisica, elegante e misurata.

Neive with Base Vela is an ode to simplicity: sober lines, soft cushions that welcome, and a suspended base that conveys lightness. A bed that combines authenticity and design, becoming an island of domestic calm. Designed for those who love naturalness, it conveys balance and serenity. As Mario Soldati wrote: *“True luxury is being able to afford simplicity.”* Neive expresses this truth, transforming rest into an aesthetic and physical experience—elegant and measured.





Letto: Neive
Tessuto di rivestimento:
collezione Couture - Acrux 121
Piede: Stilobate
Passamaneria: Bianco ottico
Tavolini: Giunto massello Noce Canaletto



mandorla



pietra calcarea



*Biancheria: collezione Lino Brouges Wafer
Cuscini arredo 50x50: rivestimento
collezione Nube Titanio
Plaid: collezione Nube Titanio*





armonia avvolgente

enveloping harmony

Armonia avvolgente e leggerezza contemporanea, la testiera accoglie con forme morbide un abbraccio soffice, capace di creare un senso di calma immediata. La base sottile sostiene con discrezione, come una linea leggera che lascia spazio alla bellezza della testiera.

Enveloping harmony and contemporary lightness: the headboard welcomes with soft forms in a gentle embrace, creating an immediate sense of calm. The slim base supports discreetly, like a light line that leaves space for the beauty of the headboard.





NEIVE

BASE FANTASMA

Neive con Base Fantasma porta leggerezza e raffinatezza all'estremo. Sospeso nello spazio, amplifica l'effetto di un segno grafico puro ed essenziale. I toni naturali donano serenità, mentre la testiera imbottita crea un accogliente rifugio visivo e fisico. È un letto che rappresenta armonia e autenticità. Come scrisse Cesare Pavese: *“Un paese vuol dire non essere soli.”* Neive con Base Fantasma diventa questo spazio interiore, capace di rassicurare e accompagnare ogni notte con sobrietà elegante.

Neive with Base Fantasma takes lightness and refinement to their extreme. Suspended in space, it amplifies the effect of a pure, essential graphic gesture. Natural tones bring serenity, while the padded headboard creates a welcoming visual and physical refuge. A bed that represents harmony and authenticity. As Cesare Pavese wrote: *“A place means not being alone.”* Neive Base Fantasma becomes this inner space, offering reassurance and accompanying every night with elegant restraint.





Letto: Neive
Tessuto di rivestimento:
collezione Lino Anversa - Wafer
Passamaneria: Blu
Poltrona: Alba Bergère tessuto di rivestimento collezio-
ne Color World - Genziana 01
Tavolino: Tratto massello Noce Canaletto





beige del meriggio



Biancheria: collezione Lino Brouges
- Avorio,
Federe: collezione Air Wash
- Beige con piping blu
Plaid: Collezione Lino Anversa - Avorio

freschezza di puro lino

the freshness of pure linen

Il rivestimento in lino con la sua eleganza semplice e materica dona al letto un aspetto luminoso e rilassato, capace di trasformare l'ambiente in uno spazio arioso e armonioso. Con il rivestimento in lino ogni dettaglio diventa un invito alla calma: un soffio di natura che porta armonia e un senso di benessere spontaneo.

The linen upholstery, with its simple, tactile elegance, gives the bed a bright and relaxed appearance, transforming the room into an airy and harmonious space. With linen upholstery, every detail becomes an invitation to calm—a breath of nature that brings harmony and a spontaneous sense of wellbeing.





ROERO

BASE BAULETTO®

Roero è ispirato ai paesaggi classici delle colline piemontesi: la testiera dalle linee morbide ricorda i profili sinuosi della natura, mentre il rivestimento in lino naturale esprime sobrietà e continuità. È un letto che parla di tradizione e misura. Come scrisse Davide Lajolo: *“La natura insegna equilibrio e misura.”* Roero trasforma questa lezione in design e accoglienza.

Roero is inspired by the classic landscapes of the Piedmont hills: the headboard's soft lines recall the sinuous profiles of nature, while the natural linen upholstery expresses sobriety and continuity. A bed that speaks of tradition and measure. As Davide Lajolo wrote: *“Nature teaches balance and measure.”* Roero transforms this lesson into design and welcome.



Letto: Roero
Tessuto di rivestimento:
collezione Lino Anversa - Avorio
Passamaneria: Oliva





Biancheria: collezione Air Wash
- Oliva con piping Cielo
Federe: collezione Air Wash
- Panna con piping Oliva
Rullo: rivestimento collezione Lino Anversa -Avorio
Plaid: collezione Lino Anversa Avorio



stile classico, respiro naturale

classic elegance, natural essence

La testiera del letto Roero con il suo profilo morbido e lievemente sagomato interpreta lo stile classico con delicatezza contemporanea. Le curve eleganti richiamano linee senza tempo mentre il rivestimento in Lino Anversa Avorio leggero e naturale dona un aspetto fresco e sofisticato.

The Roero bed headboard, with its soft and gently shaped profile, interprets classic style with contemporary delicacy. Its elegant curves recall timeless lines, while the upholstery in Anversa Ivory linen, light and natural, gives the bed a fresh and sophisticated appearance.



leggerezza senza tempo

timeless lightness

Il letto Roero con il suo profilo dolce e sinuoso esprime un romanticismo discreto ma avvolgente. Le linee morbide ricordano un gesto delicato, una curva che accoglie e addolcisce l'intera atmosfera della stanza. Perfetto per chi desidera una zona notte raffinata, romantica.

The Roero bed, with its sweet and sinuous profile, expresses a discreet yet enveloping romanticism. Soft lines recall a delicate gesture, a curve that welcomes and softens the entire atmosphere of the room. Perfect for those who desire a refined, romantic sleeping area.





LA MORRA

BASE FANTASMA

La Morra si distingue per la sua estetica pulita e contemporanea definita da una testiera ampia e perfettamente liscia donando armonia all'ambiente.

A valorizzare il design è la Base Fantasma, un dettaglio che fa apparire il letto più leggero ma al tempo stesso offre una funzionalità preziosa: un pratico bauletto contenitore capace di offrire spazio aggiuntivo senza alterare la purezza del design.

La Morra stands out for its clean, contemporary aesthetic, defined by a wide, perfectly smooth headboard that brings harmony to the space.

Enhancing the design is the Base Fantasma, a detail that makes the bed appear lighter while at the same time offering valuable functionality: a practical storage compartment that provides additional space without altering the purity of the design.





Letto: La Morra
Rivestimento in pelle: collezione
- Luna 1627
Passamaneria: Panna
Tavolini: Tratto massello Frassino Nero



gemma d'autunno

filato



*Biancheria: collezione Satin Unito
- Ostrica con ricamo cordonetto
Cuscini arredo 50x30: rivestimento
collezione Elite - Funky 52*



design essenziale, dettaglio distintivo

Essential design, distinctive detail

Design essenziale che diventa espressione di equilibrio e misura. Il dettaglio distintivo della Base Fantasma alleggerisce il volume e dona alla struttura un'elegante sensazione di sospensione.

An essential design that becomes an expression of balance and measure. The distinctive detail of the Base Fantasma lightens the volume and gives the structure an elegant sense of suspension.



contenere con stile

storing with style

La Base Fantasma offre uno spazio contenitore capiente, perfetto per mantenere la zona notte ordinata e senza rinunciare all'estetica. Ogni dettaglio è pensato per integrare funzionalità e stile con semplicità, aggiungendo un tocco di stile contemporaneo alla zona notte.

Base Fantasma offers a spacious storage compartment, perfect for keeping the sleeping area tidy without sacrificing aesthetics. Every detail is designed to integrate functionality and style with simplicity, adding a contemporary touch to the bedroom.

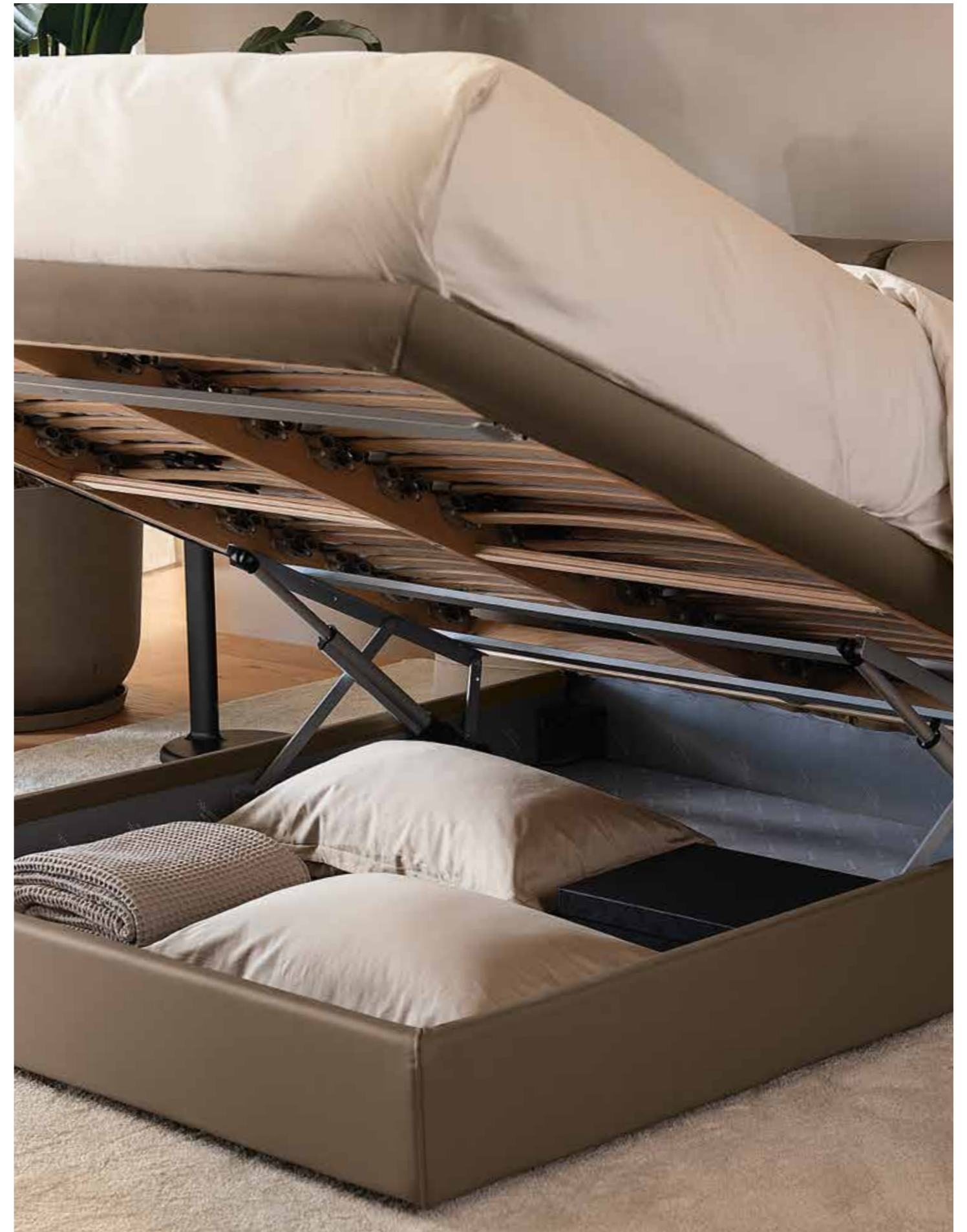



LILY

BASE TRADIZIONALE

Il letto Lily si rinnova: cuscini laterali removibili e bottoni in cocco rendono la testiera versatile, arricchita da dettagli naturali. Testiera e cuscini estremamente morbidi creano un effetto avvolgente e armonioso. Lily è continuità e sorpresa insieme, un modello che evolve restando fedele alla sua essenza. Come scrisse Massimo Mila: *“La semplicità è il segreto della bellezza.”* Lily interpreta questa verità, offrendo un equilibrio perfetto tra tradizione e modernità.

The Lily bed is renewed: removable side cushions and coconut buttons make the headboard versatile, enriched with natural details. The headboard and cushions, extremely soft, create an enveloping and harmonious effect. Lily is continuity and surprise at once—a model that evolves while remaining faithful to its essence. As Massimo Mila wrote: *“Simplicity is the secret of beauty.”* Lily interprets this truth, offering a perfect balance between tradition and modernity.





Letto: Lily
Tessuto di rivestimento:
collezione Couture - Tucano 11



#ecru dei pascoli

#smeraldo di campo



Biancheria: collezione Air Wash
- Oliva con piping Cielo
Cuscini arredo 50x30: rivestimento
collezione Couture - Tucano 11
Plaid: collezione Lino Anversa Avorio



SOMMIER

A FILO

Il Sommier a Filo, con molle insacchettate indipendenti, è pensato per chi desidera un comfort senza compromessi. Il materasso, appoggiato direttamente sul sommier, permette di ottimizzare lo spazio nella stanza, mantenendo linee pulite e armoniose. Ogni molla indipendente sostiene il corpo in modo puntuale, garantendo un riposo perfetto, mentre la struttura elegante e discreta trasforma il letto in un vero protagonista di stile e raffinatezza.

The flush sommier, with independent pocket springs, is designed for those who seek uncompromising comfort. The mattress, placed directly on the sommier, allows space to be optimised while maintaining clean, harmonious lines. Each independent spring supports the body with precision, ensuring perfect rest, while the elegant, discreet structure transforms the bed into a true statement of style and refinement.





Letto: sommier a filo
Tessuto di rivestimento:
collezione Lino Anversa - Avorio



latte di cocco



noce di cocco

Biancheria: collezione Air Wash
- Caffè con piping Cielo
Federe: collezione Lino Anversa Avorio
Cuscini arredo 50x30:
rivestimento collezione Couture
- Tucano 11
Plaid: Collezione Lino Anversa Avorio



Eccellenza del riposo tra tecnologia e artigianalità

Sleep excellence between technology and craftsmanship

Pensato per chi ricerca un comfort evoluto e considera il sonno parte integrante del proprio equilibrio, il nostro Sommier a Filo con molle insacchettate rappresenta l'incontro perfetto tra tecnologia e artigianalità garantendo un sostegno calibrato e un'ergonomia impeccabile.

Designed for those who seek advanced comfort and consider sleep an integral part of personal balance, our flush sommier with pocket springs represents the perfect meeting point between technology and craftsmanship, guaranteeing calibrated support and impeccable ergonomics.





armchair
poltrone

ALBA

bergère

Alba Bergère unisce comfort e raffinatezza con la naturalezza di un gesto compiuto a mano. Le linee morbide accolgono il corpo, mentre la rotondità della seduta e dello schienale avvolgente crea un rifugio intimo e sofisticato. Pensata per dialogare con ogni ambiente, si distingue per proporzione e armonia senza tempo. Come scrisse Cesare Pavese: *“L’unica gioia al mondo è cominciare.”* Alba Bergère è l’inizio perfetto di ogni momento di quiete domestica.

Alba Bergère combines comfort and refinement with the natural ease of a handcrafted gesture. Soft lines welcome the body, while the rounded seat and enveloping backrest create an intimate and sophisticated retreat. Designed to dialogue with any interior, it stands out for its proportions and timeless harmony. As Cesare Pavese wrote: *“The only joy in the world is beginning.”* Alba Bergère is the perfect beginning for every moment of domestic calm.



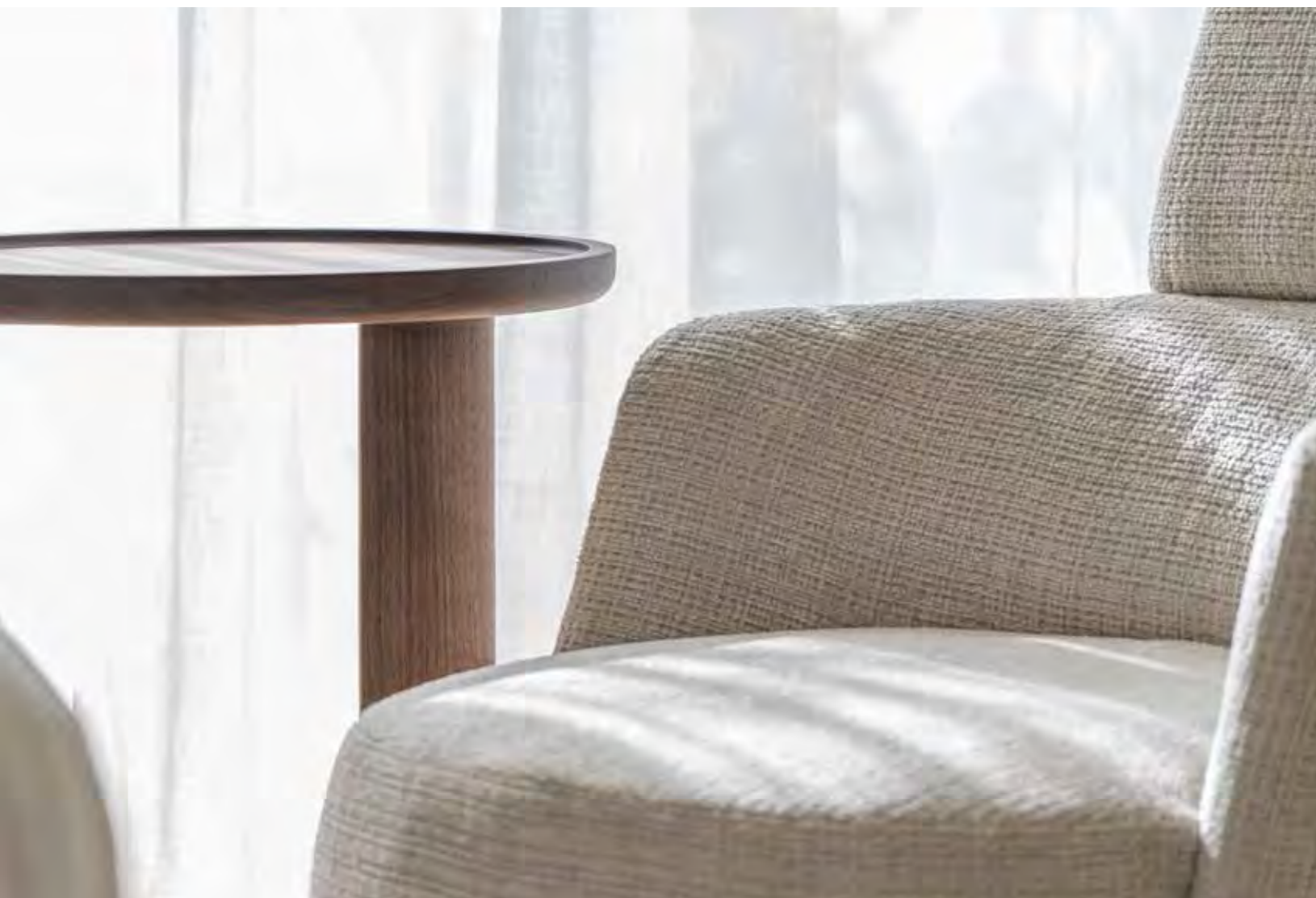

rotondità di classe

rounded elegance

Un'icona di stile avvolgente e confortevole Alba Bergère è puro invito al relax. Con un design essenziale e lineare, Alba Bergère conquista lo spazio circostante con raffinata eleganza. Le sue forme pulite e armoniose la rendono versatile e si adatta a qualsiasi ambiente, dalla camera da letto al soggiorno, integrandosi con diversi stili d'arredo.

An icon of enveloping, comfortable style, Alba Bergère is a pure invitation to relax. With an essential, linear design, it enhances the surrounding space with refined elegance. Its clean, harmonious shapes make it versatile and adaptable to any setting, from the bedroom to the living area, integrating effortlessly with different interior styles.





ALBA

poltroncina

Compatta e accogliente, Alba Poltroncina trasforma il gesto del sedersi in un abbraccio. Le forme morbide e avvolgenti dialogano con dettagli in legno naturale, creando un equilibrio tra essenzialità e calore. Pensata per accompagnare i momenti di lettura o di pausa, offre comfort senza rinunciare allo stile. Come scrisse Guido Gozzano: *“Le piccole cose che fanno la vita.”* Alba Poltroncina è quell’attimo prezioso di intimità quotidiana che diventa pura eleganza.

Compact and welcoming, Alba Poltroncina transforms the act of sitting into an embrace. Soft, enveloping forms interact with natural wood details, creating a balance between essential design and warmth. Designed to accompany moments of reading or pause, it offers comfort without sacrificing style. As Guido Gozzano wrote: *“The little things that make up life.”* Alba Poltroncina is that precious moment of everyday intimacy that becomes pure elegance.





linee che abbracciano

lines that embrace

Alba Poltroncina presenta una forma avvolgente e una struttura gentile offrendo un equilibrio perfetto tra forma e funzione. Dimensioni compatte e proporzioni bilanciate rendono questa poltroncina la scelta perfetta per ambienti contemporanei e funzionali.

Alba Poltroncina features an enveloping shape and a gentle structure, offering a perfect balance between form and function. Compact dimensions and balanced proportions make this armchair the ideal choice for contemporary, functional interiors.

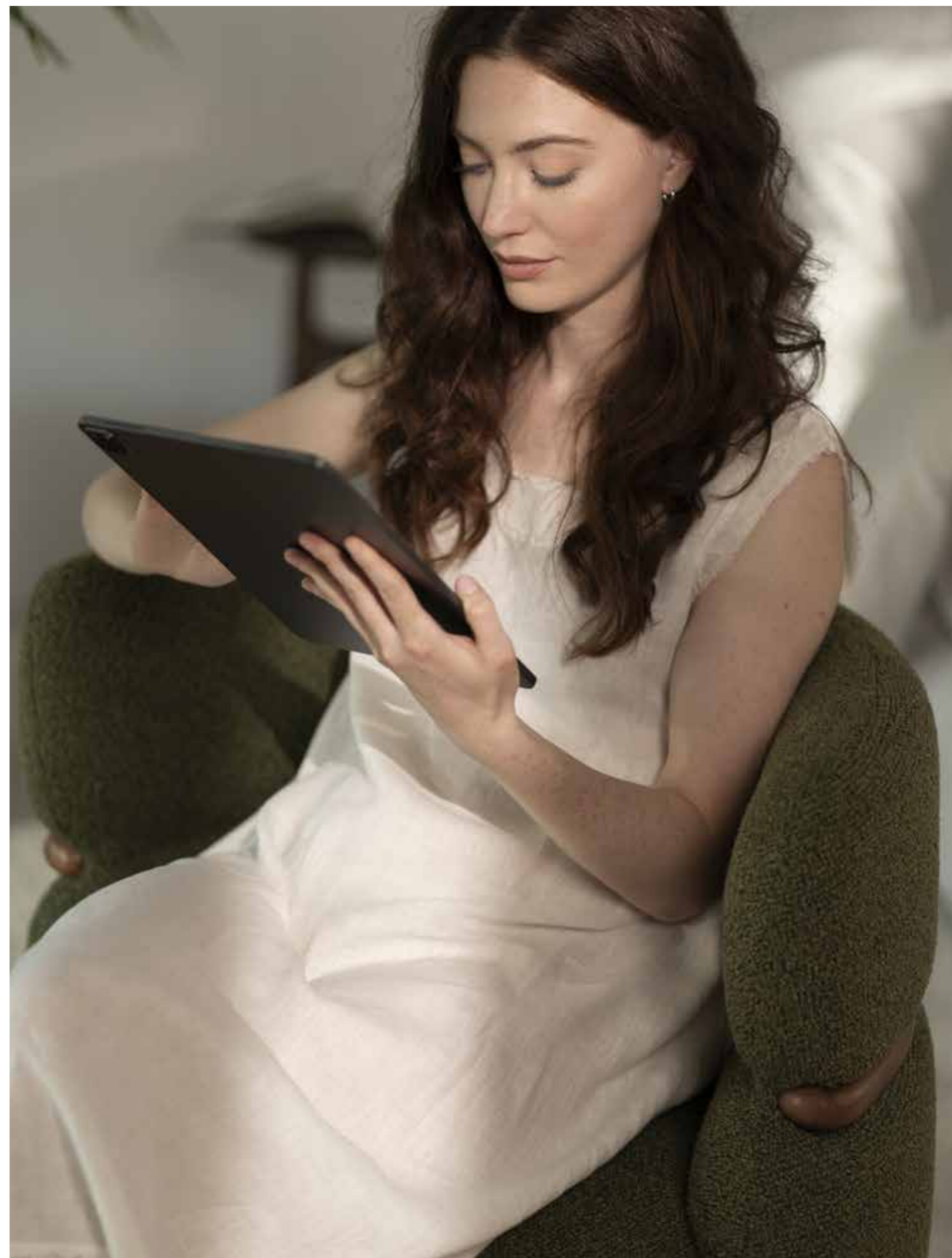





mattresses •
mattressi



le proposte sfoderabili

proposals of removable covers

Le collezioni di materassi BI-NATURAL e BI-COMFORT uniscono innovazione e praticità, offrendo soluzioni pensate per il massimo comfort e igiene.

Ad eccezione del modello BI-VINTAGE, che si distingue per la sua tradizionale confezione "giffata", tutti gli altri modelli della linea sono dotati di esclusive cuffie sfoderabili e lavabili.

Questa caratteristica permette una gestione semplice e pratica della manutenzione, assicurando un riposo sempre fresco e igienico. Le fodere, realizzate con materiali di alta qualità, sono progettate per garantire resistenza, traspirabilità e un'elevata sensazione di benessere.

The BI-NATURAL and BI-COMFORT mattress collections combine innovation and practicality, offering solutions designed for maximum comfort and hygiene.

With the exception of the BI-VINTAGE model, which stands out for its traditionally "quilted" construction, all other models in the range feature exclusive removable and washable top covers.

This feature ensures simple and convenient care, providing a consistently fresh and hygienic sleep surface. The covers, made from high-quality materials, are designed to ensure durability, breathability, and a heightened sense of wellbeing.

BI-NATURAL

NATURAL SYSTEM



BI-VINTAGE H.32



BI-GREEN H.25

BI-COMFORT

HYBRID SYSTEM



BI-POWER H.31



BI-PROGRESS H.31



BI-ACTION H.26

FOAM SYSTEM



BI-PORE H.30



BI-FLEX H.25

POCKET SYSTEM



BI-MOON H.31



BI-MIND H.26



lattice 100%
origine naturale

OEKO-TEX®
CONFIDENCE IN TEXTILES

Havea brasiliensis è la fonte del lattice 100 % di origine naturale utilizzato per i materassi Altrenotti.

The source of Altrenotti's 100% natural latex is **Hevea brasiliensis**.

collezione Bi-Natural
lattice 100%
di origine naturale
100% natural latex

Il lattice 100% di origine naturale utilizzato da Altrenotti è uno dei materiali più elastici in assoluto. La sua capacità istantanea di tornare alla forma originale dopo pressioni e allungamenti lo rende una delle migliori soluzioni ergonomiche per la realizzazione dei nostri materassi. Questa straordinaria reattività assicura un sostegno ottimale e un comfort su misura, adattandosi perfettamente alle curve del corpo e favorendo un riposo profondo e rigenerante. Oltre alle sue eccezionali proprietà elastiche, il lattice naturale offre un vantaggio fondamentale per l'igiene del sonno. Questo lo rende ideale per chi cerca un materasso che coniughi benessere, durata e protezione, nel pieno rispetto della natura.

The 100% natural latex used by Altrenotti is among the most elastic materials available. Its immediate ability to return to its original shape after pressure or stretching makes it one of the best ergonomic solutions for our mattresses. This exceptional responsiveness ensures optimal support and tailored comfort, perfectly adapting to the body's contours to promote deep, restorative rest. In addition to its outstanding elastic properties, natural latex offers a fundamental advantage in terms of sleep hygiene. This makes it an ideal choice for those seeking a mattress that combines wellbeing, durability, and protection — all in full harmony with nature.



Puro lattice di origine 100% naturale MICROFORATO



collezione Bi-Natural

crine di cavallo naturale

natural horsehair

Nel nostro materasso BI-VINTAGE utilizziamo crine di cavallo di altissima qualità. Totalmente privo di allergeni, è ideale anche per le persone più sensibili. Questo materiale naturale possiede inoltre proprietà antibatteriche, anti-fungine e anti-acaro, contribuendo a mantenere un ambiente di riposo sano e igienico. Una scelta che unisce tradizione, comfort e benessere per un sonno rigenerante.

In our BI-VINTAGE mattress, we use the highest quality horsehair. Completely allergen-free, it is ideal even for the most sensitive individuals. This natural material also possesses antibacterial, anti-fungal, and anti-dust mite properties, helping to maintain a healthy and hygienic sleep environment. A choice that blends tradition, comfort, and wellbeing for truly restorative sleep.

YOU & ME

solution

La tecnologia YOU&ME di Altrenotti è stata sviluppata per offrire un comfort su misura a ogni persona, adattandosi perfettamente alle diverse esigenze di Lui e Lei. Grazie a una struttura innovativa che accosta due diverse portanze, ogni lato del materasso è progettato per rispondere in modo specifico alle caratteristiche fisiche di chi lo utilizza.

Questa soluzione garantisce un sostegno personalizzato e bilanciato, rispettando la naturale conformazione del corpo e assicurando un riposo profondo e rigenerante.

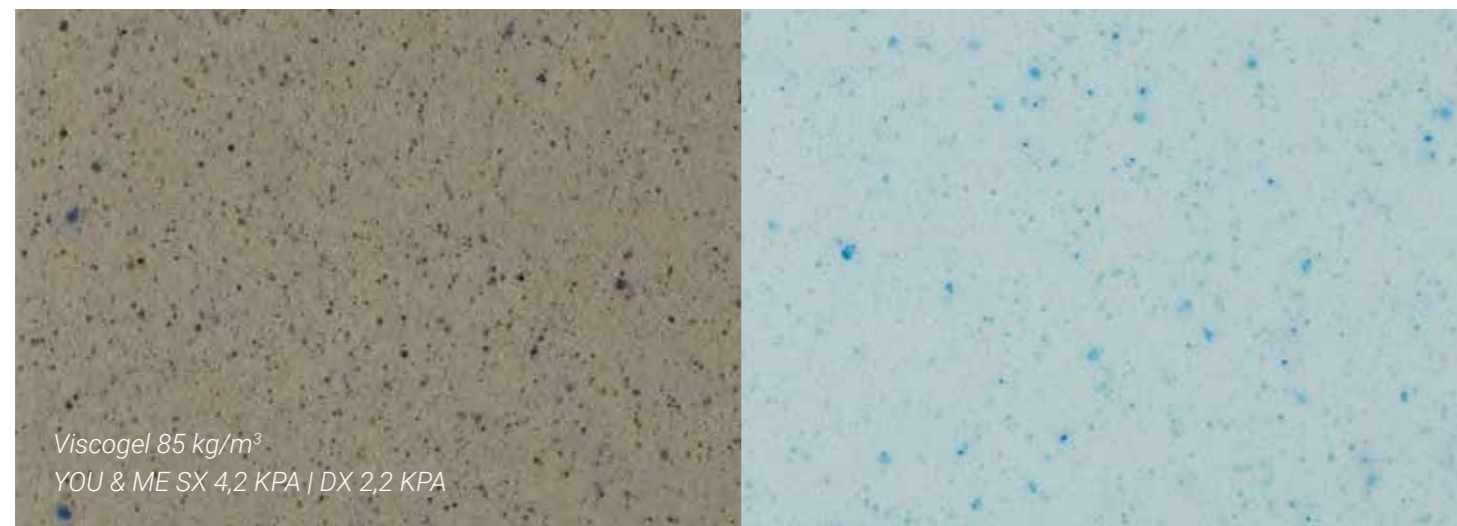

Con YOU&ME, il comfort non è più un compromesso: ciascun partner può vivere la propria esperienza di sonno ideale, senza rinunciare alla qualità e all'equilibrio di un materasso progettato per il benessere di entrambi.

Altrenotti's You&Me technology has been developed to provide tailor-made comfort for each individual, perfectly adapting to the specific needs of both him and her. Thanks to an innovative structure combining two different firmness levels, each side of the mattress is designed to respond specifically to the physical characteristics of the person using it.

This solution ensures personalised and balanced support, respecting the natural shape of the body and promoting deep, restorative rest.

With You&Me, comfort is no longer a compromise: each partner can enjoy their own ideal sleep experience without sacrificing the quality and harmony of a mattress designed for both.





materassi

BI-NATURAL



BI-VINTAGE H.32



BI-GREEN H.25

BI-VINTAGE

h. 32

Materasso BI-VINTAGE H.32 in PURO LATTICE 100% DI ORIGINE NATURALE MICROFORATO, CRINE DI CAVALLO e nuovo molleggio PRIVATE "ELEVATED CARBON COIL" POCKET SPRING H.15 cm.

BI-VINTAGE MATTRESS H.32 in 100% NATURAL ORIGIN MICRO PERFORATED PURE LATEX, with NATURAL HORSEHAIR and the new PRIVATE "ELEVATED CARBON COIL" spring system H.15 cm.

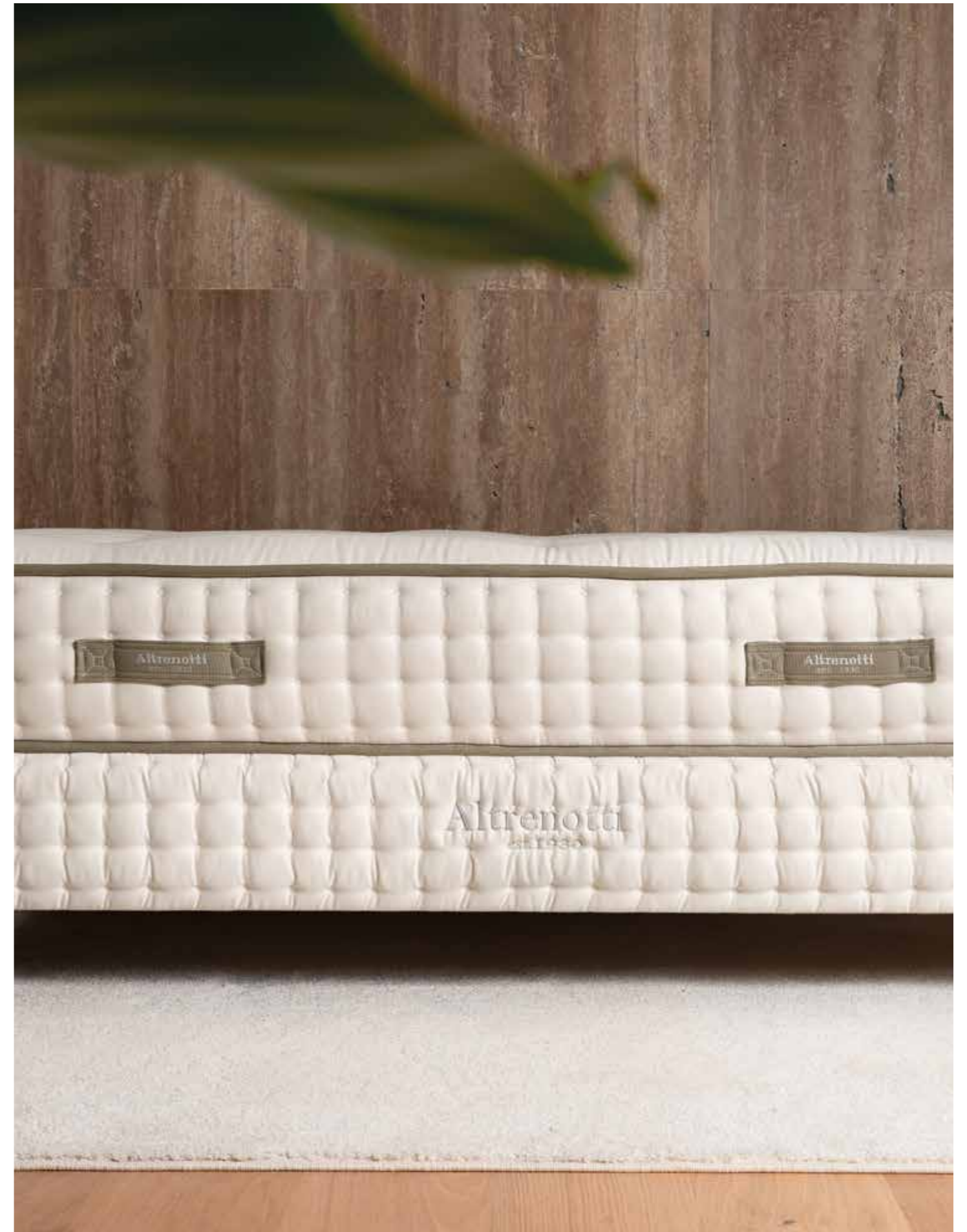

BI-VINTAGE

h. 32



warranty



lattice 100%
origine naturale



crine di cavallo



cachemire
bamboo ineden

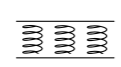

elevated
carbon coil



con topper



reverse

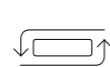

reverse



medical device

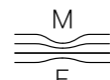

M

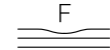

F



F

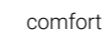

M



M

comfort

PROGRESSIVE COMFORT

REACTIVE COMFORT

TECHNOLOGY

PANNELLO SUPERIORE

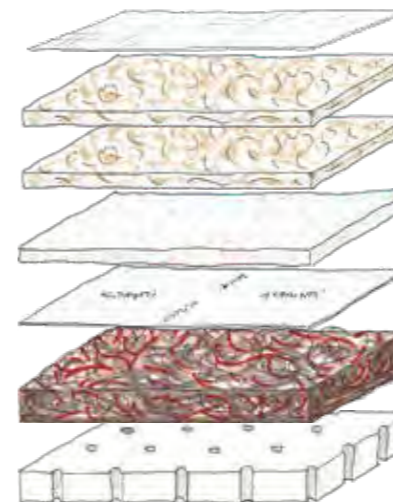

- ① Rivestimento JACQUARD doppio ritorto ORGANIC-COTTON & SEACELL
- ② Blended 250 g/m²: cachemire + bamboo + ineden
- ③ Blended 250 g/m²: cachemire + bamboo + ineden
- ④ FILL.IT anallergico 4 STAGIONI 200 g/m²
- ⑤ Microfibra brandizzata
- ⑥ Crine di cavallo agugliato
- ⑦ PURO LATTICE 100% DI ORIGINE NATURALE MICROFORATO H.5 cm

CORPO CENTRALE

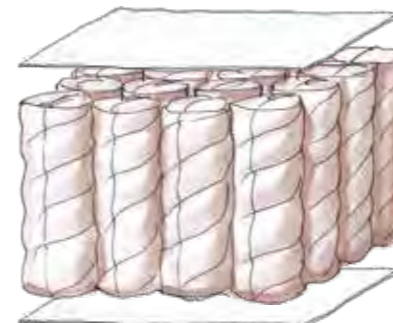

- ⑧ Needle Punch
- ⑨ Nuovo molleggio PRIVATE "ELEVATED CARBON COIL" POCKET SPRING H.15 cm
- ⑩ Needle Punch

PANNELLO INFERIORE

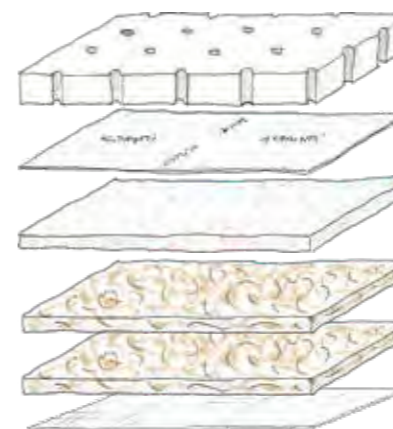

- ⑪ PURO LATTICE 100% DI ORIGINE NATURALE MICROFORATO H.5 cm
- ⑫ Microfibra brandizzata trapuntata
- ⑬ FILL.IT anallergico 4 STAGIONI 200 g/m²
- ⑭ Blended 250 g/m²: cachemire + bamboo + ineden
- ⑮ Blended 250 g/m²: cachemire + bamboo + ineden
- ⑯ Rivestimento JACQUARD doppio ritorto ORGANIC-COTTON & SEACELL



BI-VINTAGE

giffatura capitonnè

hand-tufted craftsmanship

Il materasso BI-VINTAGE è il risultato di un'eccellenza artigianale senza tempo. La tecnica della giffatura capitonnè tradizionale, realizzata esclusivamente a mano, assicura che l'imbottitura rimanga sempre stabile, evitando spostamenti nel tempo e garantendo un sostegno costante. Un dettaglio che non solo esalta la qualità del riposo, ma prolunga la durata del materasso, rendendolo un vero investimento in comfort e benessere.

La giffatura capitonnè è una tecnica artigianale tradizionale utilizzata nella trapuntatura dei materassi di alta qualità. Questo metodo prevede l'inserimento manuale di punti di fissaggio profondi che attraversano l'intero spessore del materasso, mantenendo compatta e ben distribuita l'imbottitura interna. Il risultato è una superficie sempre uniforme, capace di garantire un sostegno ottimale nel tempo e di preservare la forma e la durata del materasso. Un dettaglio di lavorazione che esalta la qualità del riposo, combinando estetica, funzionalità e resistenza.

The Bi-Vintage mattress is the result of timeless artisanal excellence. Its traditional hand-tufting technique, carried out entirely by hand, ensures the filling remains firmly in place, preventing displacement over time and guaranteeing consistent support. This detail not only enhances sleep quality but also extends the lifespan of the mattress, making it a true investment in comfort and wellbeing.

Hand-tufting is a traditional artisanal method used in the quilting of high-end mattresses. It involves the manual insertion of deep securing stitches that run through the entire thickness of the mattress, keeping the internal padding compact and evenly distributed. The result is a consistently even surface that delivers optimal support over time, preserving the mattress's shape and durability. A fine detail of craftsmanship that enhances sleep quality by combining aesthetics, functionality, and long-lasting performance.



BI-VINTAGE

topper h. 5



TECHNOLOGY TOPPER



BI-GREEN

h. 25

Materasso BI-GREEN H.25 in puro LATTICE 100% DI ORIGINE NATURALE MICROFORATO, disponibile in tre comfort e nella versione YOU&ME.

BI-GREEN H.25 mattress in 100% NATURAL ORIGIN MICRO-PERFORATED PURE LATEX, available in three comfort levels and in the You&Me version.



BI-GREEN

h. 25



warranty



lattice 100%
origine naturale

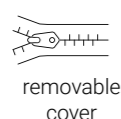

removable
cover



adjustable

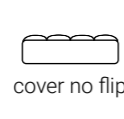

cover no flip

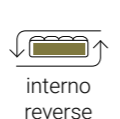

interno
reverse



25



30

con topper



medical device

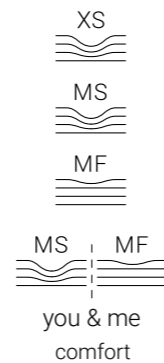

you & me
comfort

TECHNOLOGY

PANNELLO SUPERIORE

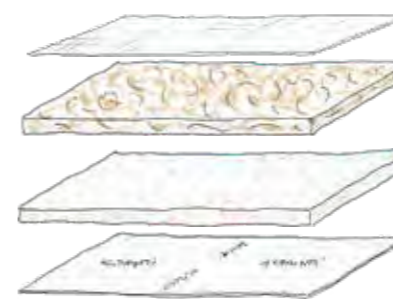

- ① Rivestimento STRETCH ORGANICOTTON & ELASTAN
- ② Blended 250 g/m²: cachemire + bamboo + ineden
- ③ FILL.IT anallergico 4 STAGIONI 200 g/m²
- ④ Microfibra Brandizzata

CORPO CENTRALE

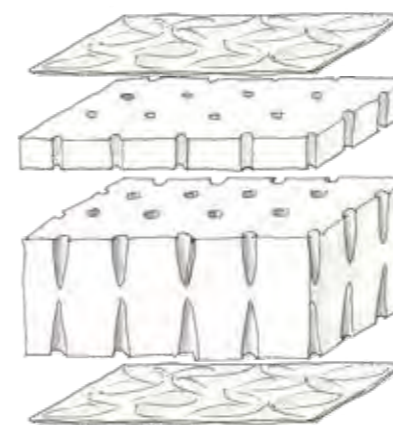

- ⑤ Cuffia in cotone elasticizzata
- ⑥ PURO LATTICE 100% DI ORIGINE NATURALE MICROFORATO H.5 cm
- ⑦ PURO LATTICE 100% DI ORIGINE NATURALE MICROFORATO H.15 cm
- ⑧ Cuffia in cotone elasticizzata

PANNELLO INFERIORE



- ⑨ Needle Punch
- ⑩ FILL.IT anallergico 4 STAGIONI 200 g/m²
- ⑪ Microfibra brandizzata trapuntata

PROGRESSIVE COMFORT

REACTIVE COMFORT

BI-GREEN

adjustable

Il materasso BI-GREEN combina innovazione e comfort naturale, offrendo un'esperienza di riposo altamente personalizzabile.

Il materasso è progettato per adattarsi perfettamente alle reti motorizzate, garantendo il massimo benessere in ogni posizione.

Grazie a questa soluzione avanzata, il letto matrimoniale, composto da due materassi indipendenti, permette a ciascun partner di regolare il proprio lato in base alle esigenze di comfort e postura. Che si tratti di leggere, rilassarsi o dormire con un'inclinazione personalizzata, BI-GREEN assicura una libertà di movimento totale, senza compromessi.

The BI-GREEN mattress blends innovation with natural comfort, offering a highly customisable sleep experience.

It is specifically designed to be compatible with motorised bed bases, ensuring maximum wellbeing in every position.

Thanks to this advanced solution, the double bed – composed of two independent mattresses – allows each partner to adjust their side according to their personal comfort and posture needs. Whether for reading, relaxing, or sleeping at a custom incline, BI-GREEN provides total freedom of movement with no compromise.



BI-GREEN

topper h. 5



TECHNOLOGY TOPPER





materassi

BI-COMFORT

HYBRID SYSTEM



BI-POWER H.31



BI-PROGRESS H.31



BI-ACTION H.26

FOAM SYSTEM



BI-PORE H.30



BI-FLEX H.25

POCKET SYSTEM



BI-MOON H.31



BI-MIND H.26

BI-POWER

h. 31

Materasso BI-POWER H.31 con nuovo molleggio PRIVATE "ELEVATED CARBON COIL" POCKET SPRING H.15 cm, disponibile in due comfort e nella versione YOU&ME.

BI-POWER H.31 mattress with new PRIVATE "ELEVATED CARBON COIL" POCKET SPRING system, H.15 cm, available in two comfort options and in the You&Me version.

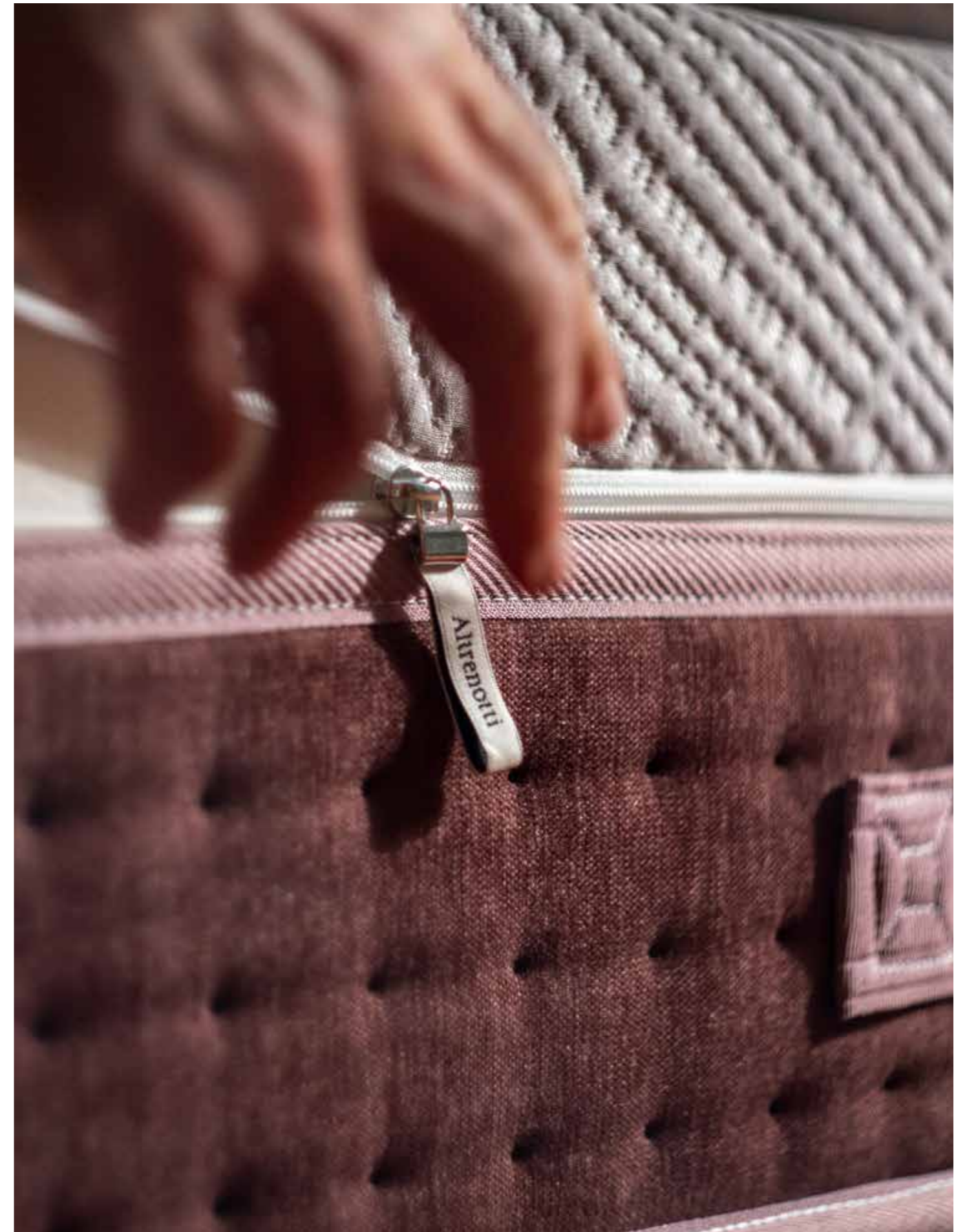

BI-POWER

h. 31

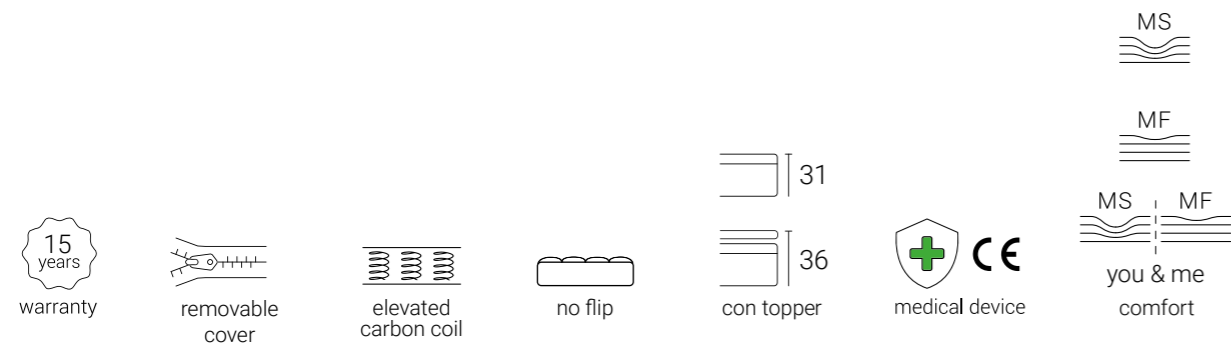

TECHNOLOGY

PANNELLO SUPERIORE



CORPO CENTRALE



PANNELLO INFERIORE



PROGRESSIVE COMFORT

NO FLIP

BI-POWER

topper h. 5



TECHNOLOGY TOPPER

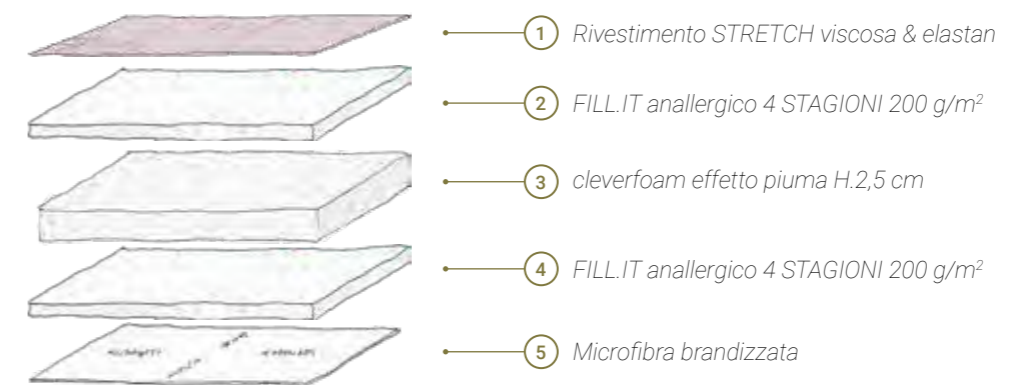

BI-PROGRESS

h. 31

Materasso BI-PROGRESS H.31 con nuovo molleggio PRIVATE "ELEVATED CARBON COIL" POCKET SPRING H.20, disponibile in due comfort e nella versione YOU&ME.

BI-PROGRESS H.31 mattress with new PRIVATE "ELEVATED CARBON COIL" POCKET SPRING system, H.20 cm, available in two comfort options and in the You&Me version.

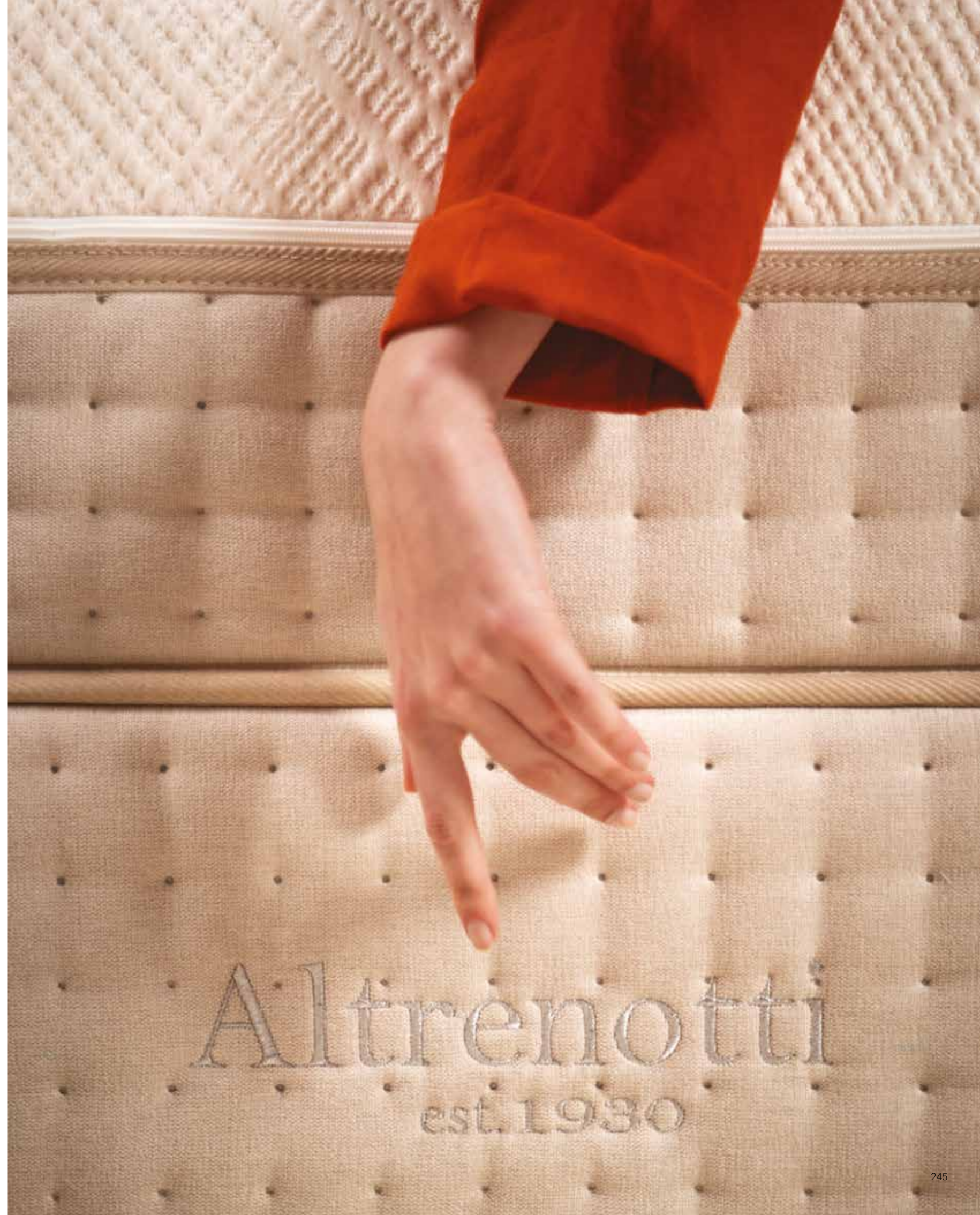

BI-PROGRESS

h. 31



15 years warranty

removable cover

elevated carbon coil

no flip

31
36
con topper

medical device

MF
M
MF M
you & me comfort

TECHNOLOGY

PANNELLO SUPERIORE



① Rivestimento STRETCH viscosa & elasthan

CORPO CENTRALE



② Cuffia in cotone elasticizzata

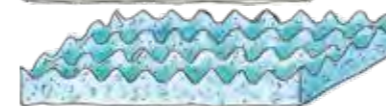

③ cleverfoam effetto piuma bugnato H.2,5 cm

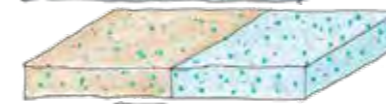

④ Viscogel 85 kg/m³ (YOU & ME SX 4,2 KPA | DX 2,2 KPA) H.4 cm



⑤ Needle Punch



⑥ Nuovo molleggio PRIVATE "ELEVATED CARBON COIL" POCKET SPRING H.20 cm



⑦ Needle Punch



⑧ GRAVITYFOAM Firm H.3 cm



⑨ Cuffia in cotone elasticizzata

PANNELLO INFERIORE



⑩ Needle Punch



⑪ FILL.IT anallergico 4 STAGIONI 200 g/m²



⑫ Rivestimento microfibra brandizzata trapuntata

PROGRESSIVE COMFORT

NO FLIP

BI-PROGRESS

topper h. 5



TECHNOLOGY TOPPER

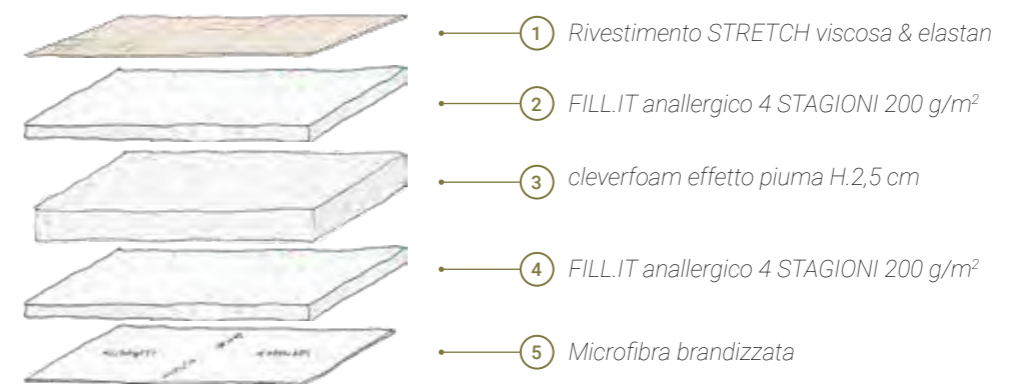

BI-ACTION

h. 26

Materasso BI-ACTION H.26 con nuovo molleggio PRIVATE "ELEVATED CARBON COIL" POCKET SPRING H.15 cm, disponibile in due comfort e nella versione YOU&ME.

BI-ACTION H.26 mattress with new PRIVATE "ELEVATED CARBON COIL" POCKET SPRING system, H.15 cm, available in two comfort options and in the You&Me version.



BI-ACTION

h. 26



15 years warranty

removable cover

elevated carbon coil

no flip

26 con topper

medical device CE

F MF you & me comfort

TECHNOLOGY

PANNELLO SUPERIORE



① Rivestimento STRETCH viscosa & elasthan

CORPO CENTRALE



② Cuffia in cotone elasticizzata

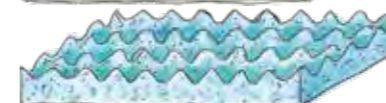

③ cleverfoam effetto piuma bugnato H.2,5 cm

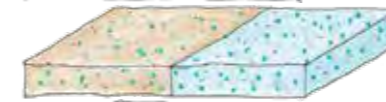

④ Viscogel 85 kg/m³ (YOU & ME SX 4,2 KPA | DX 2,2 KPA) H.4 cm



⑤ Needle Punch



⑥ Nuovo molleggio PRIVATE "ELEVATED CARBON COIL" POCKET SPRING H.15 cm



⑦ Needle Punch



⑧ GRAVITYFOAM Firm H.3 cm



⑨ Cuffia in cotone elasticizzata

PANNELLO INFERIORE



⑩ Needle Punch



⑪ FILL.IT anallergico 4 STAGIONI 200 g/m²



⑫ Rivestimento microfibra brandizzata trapuntata

PROGRESSIVE COMFORT

NO FLIP

BI-ACTION

topper h. 5



TECHNOLOGY TOPPER

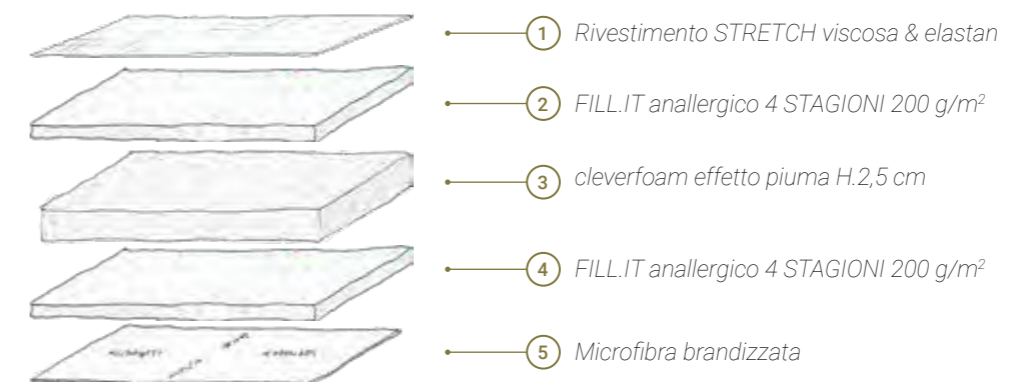

BI-PORE

h. 30

Materasso BI-PORE H.30 con nuova tecnologia AQUA-PORE GEL.

BI-PORE H.30 mattress with advanced AQUAPORE GEL technology.



BI-PORE

h. 30



warranty

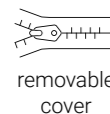

removable cover

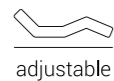

adjustable

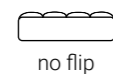

no flip

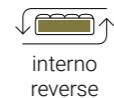

interno reverse



30



35

con topper



medical device



comfort

TECHNOLOGY

PANNELLO SUPERIORE



- ① Rivestimento STRETCH viscosa & elasthan

CORPO CENTRALE



- ② Cuffia in cotone elasticizzata



- ③ AQUAPORE GEL H.4 cm



- ④ MINDFOAM memory 50 kg/m³ H.4 cm



- ⑤ GRAVITYFOAM Firm H.15 cm



- ⑥ AQUAPORE GEL Bugnato H.4 cm



- ⑦ Cuffia in cotone elasticizzata

PANNELLO INFERIORE



- ⑪ Needle Punch

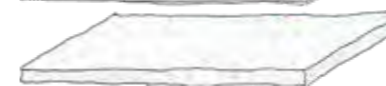

- ⑫ FILL.IT anallergico 4 STAGIONI 200 g/m²



- ⑬ Rivestimento microfibra brandizzata trapuntata

PROGRESSIVE COMFORT

REACTIVE COMFORT

BI-PORE

topper h. 5



TECHNOLOGY TOPPER

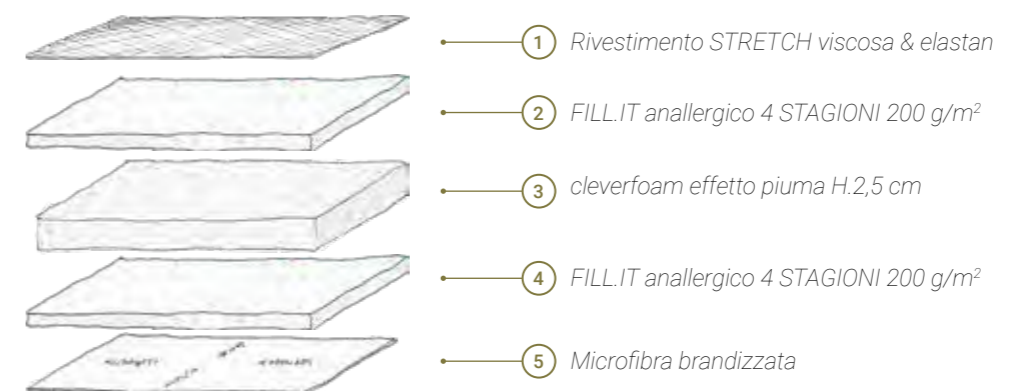

BI-FLEX

h. 25

Materasso BI-FLEX H.25 con nuova tecnologia AQUA-
PORE GEL.

BI-FLEX H.25 mattress with advanced AQUA-
GEL technology.

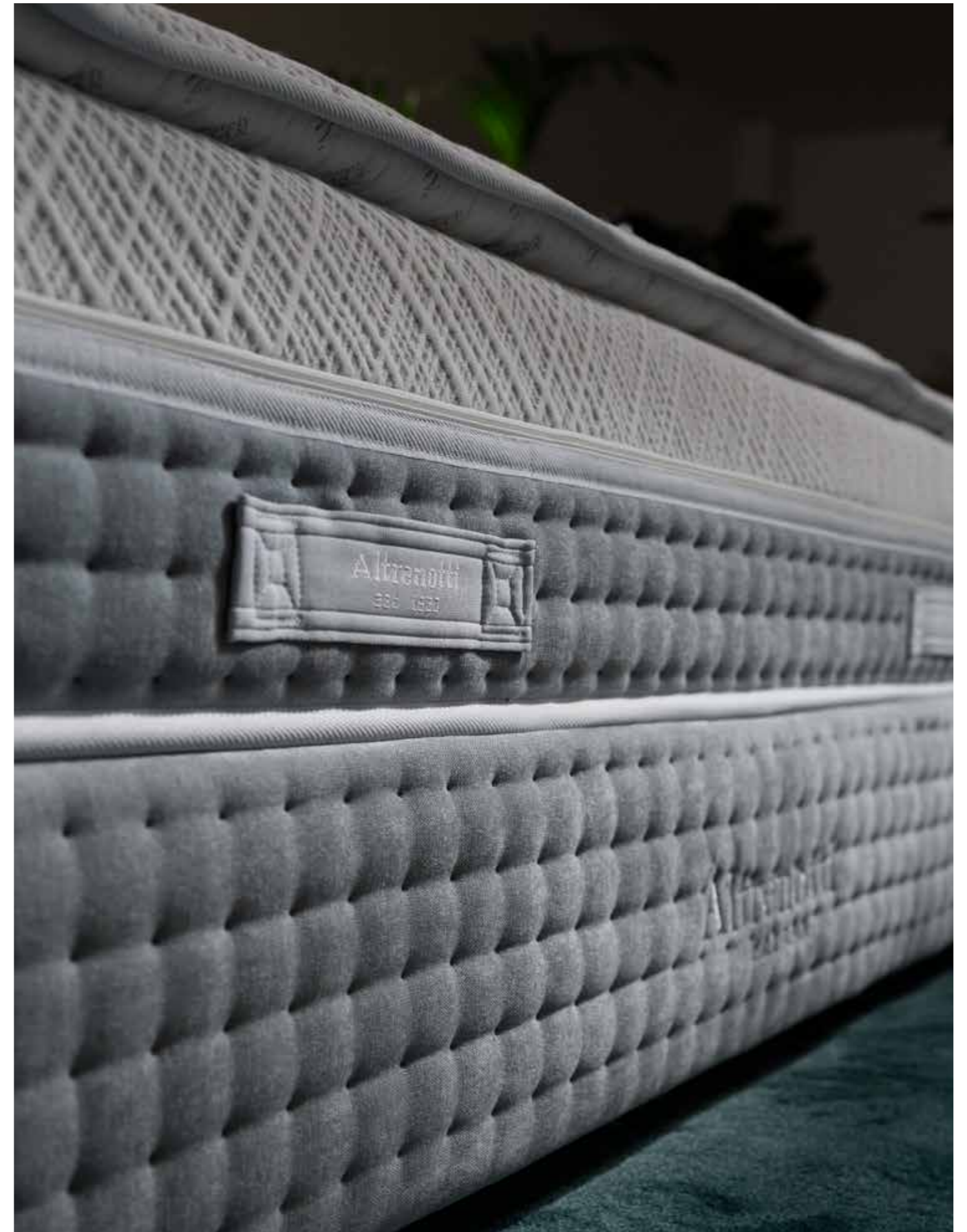

BI-FLEX

h. 25



warranty

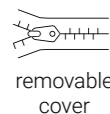

removable cover

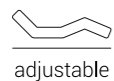

adjustable

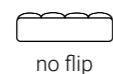

no flip

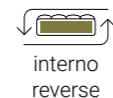

interno reverse



25



30

con topper



medical device



comfort

TECHNOLOGY

PANNELLO SUPERIORE



① Rivestimento STRETCH viscosa & elasthan

CORPO CENTRALE



② Cuffia in cotone elasticizzata



③ AQUAPORE GEL H.4 cm



④ MINDFOAM memory 50 kg/m³ H.4 cm



⑤ GRAVITYFOAM Firm H.15 cm



⑥ Cuffia in cotone elasticizzata

PANNELLO INFERIORE



⑦ Needle Punch

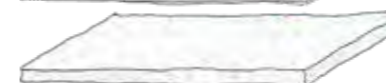

⑧ FILL.IT anallergico 4 STAGIONI 200 g/m²



⑨ Rivestimento microfibra brandizzata trapuntata

PROGRESSIVE COMFORT

REACTIVE COMFORT

BI-FLEX

topper h. 5



TECHNOLOGY TOPPER

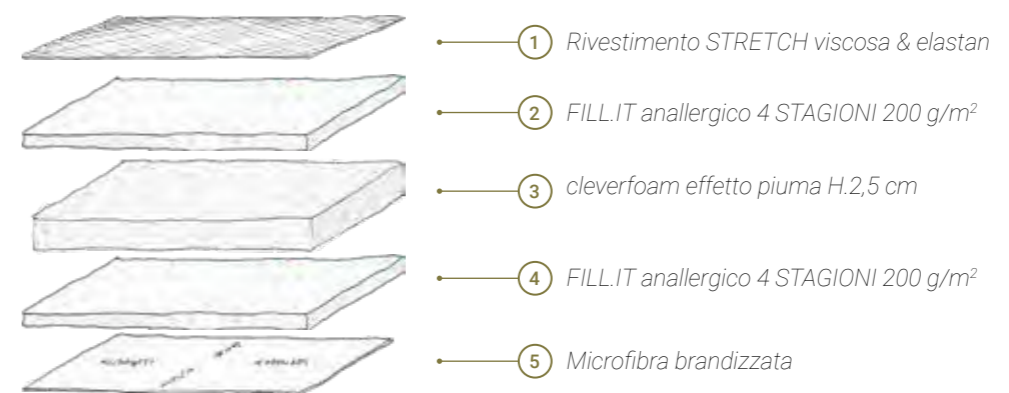

BI-MOON

h. 31

Materasso BI-MOON H.31 con nuovo molleggio PRIVATE "ELEVATED CARBON COIL" POCKET SPRING H.20 cm.

BI-MOON H.31 mattress with new PRIVATE "ELEVATED CARBON COIL" POCKET SPRING system, H. 20 cm.



BI-MOON

h. 31



15 years warranty

optional

elevated carbon coil

no flip

31
36
con topper

medical device

MF
MS
comfort

TECHNOLOGY

PANNELLO SUPERIORE

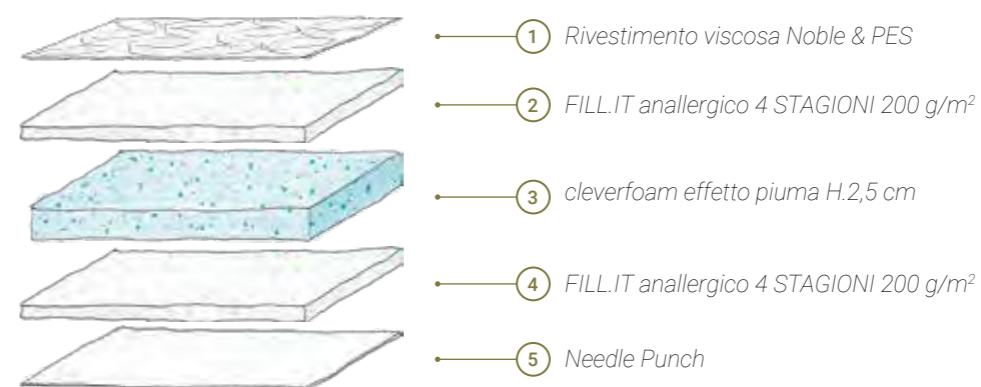

CORPO CENTRALE

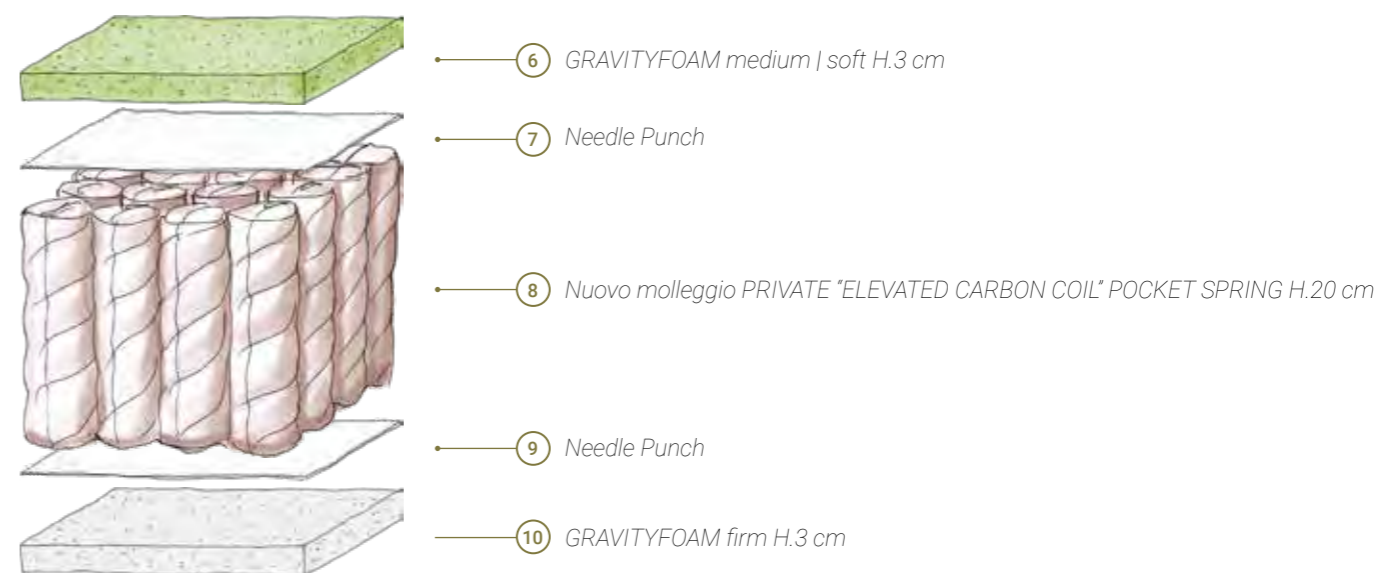

PANNELLO INFERIORE



PROGRESSIVE COMFORT

NO FLIP

BI-MOON

topper h. 5



TECHNOLOGY TOPPER

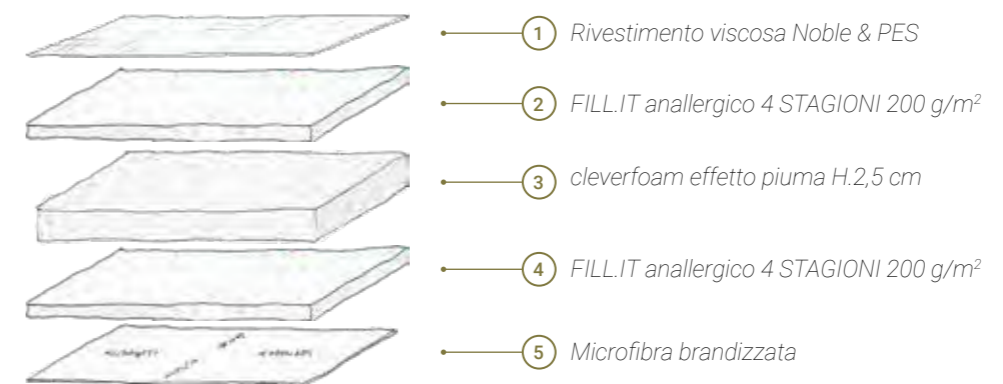

BI-MIND

h. 26

Materasso BI-MIND H.26 con nuovo molleggio PRIVATE "ELEVATED CARBON COIL" POCKET SPRING H.15 cm.

BI-MIND H.26 mattress with new PRIVATE "ELEVATED CARBON COIL" POCKET SPRING system, H. 15 cm.



BI-MIND

h. 26



15 years warranty

optional

elevated carbon coil

no flip

26
31
con topper

medical device

M
F
comfort

TECHNOLOGY

PANNELLO SUPERIORE

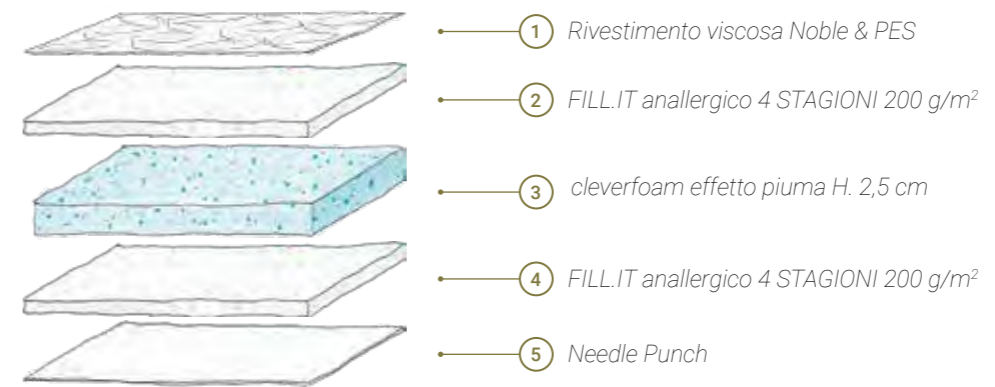

CORPO CENTRALE

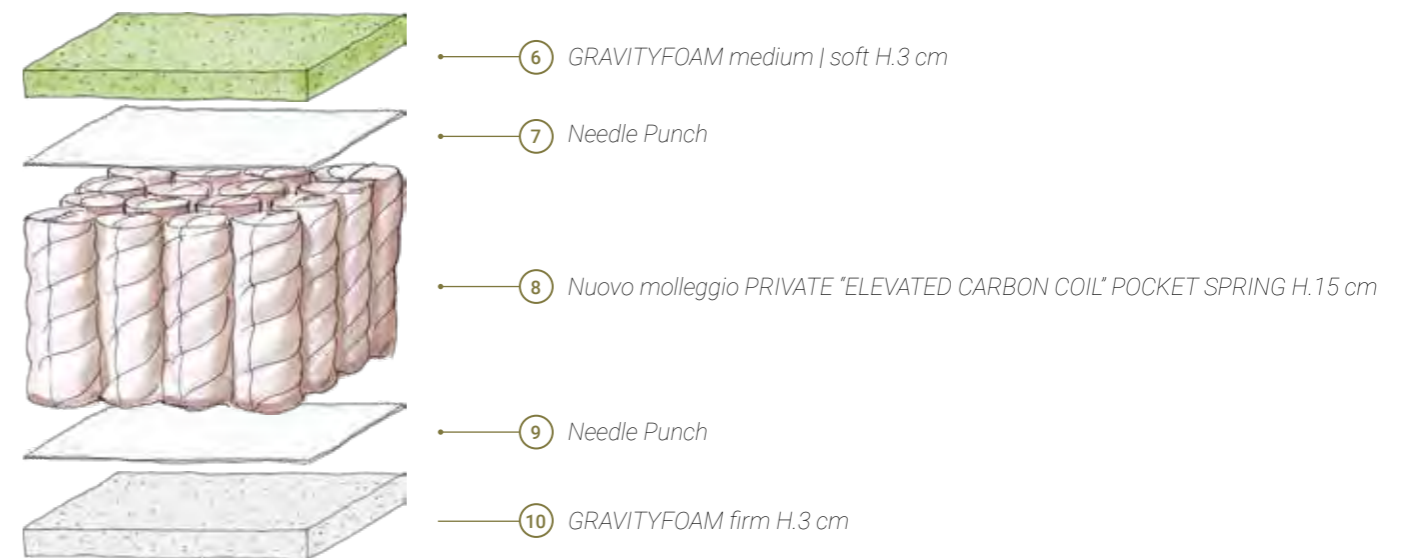

PANNELLO INFERIORE



PROGRESSIVE COMFORT

NO FLIP

BI-MIND

topper h. 5



TECHNOLOGY TOPPER

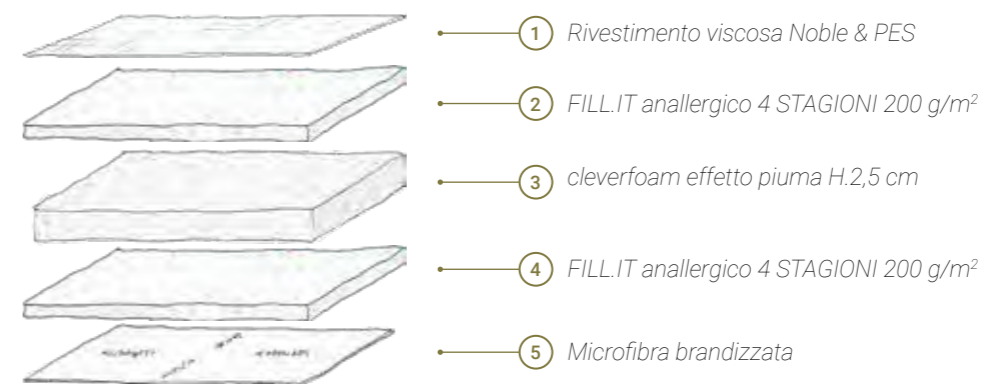



sleep systems
sistemi di riposo

PIANI DI RIPOSO

sleeping platforms



BI-METAL



BI-WOOD



BI-WIRELESS



SOMMIER A INCASSO



SOMMIER A FILO

BASI

bases



BASE VELA



BASE FANTASMA



BASE TRADIZIONALE



BASE BAULETTO®



BASE SOMMIER A INCASSO



BASE SOMMIER A FILO

SISTEMA LEGGERO

BI-METAL



BASE VELA



SISTEMA CLASSICO

BI-WOOD



BASE TRADIZIONALE



BI-WOOD



BASE BAULETTO®

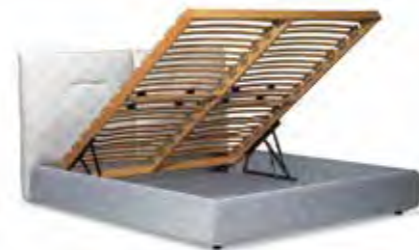

BI-WOOD



BASE FANTASMA



SISTEMA DINAMICO

BI-WIRELESS



BASE TRADIZIONALE



BI-WIRELESS



BASE BAULETTO®



BI-WIRELESS



BASE FANTASMA



SISTEMA A MOLLE

CON SOMMIER A INCASSO
recessed sommier



BASE TRADIZIONALE



CON SOMMIER A FILO
flush sommier



BASE SOMMIER A FILO





BI-METAL

metal slatted bases



Rete strutturale autoportante utilizzata esclusivamente per la Base Vela è composta da 36 doghe in legno con regolatori di rigidità, studiata per un supporto ergonomico personalizzabile.

A self-supporting structural slatted frame, used exclusively for Base Vela, made up of 36 wooden slats with firmness regulators, designed to provide customisable ergonomic support.

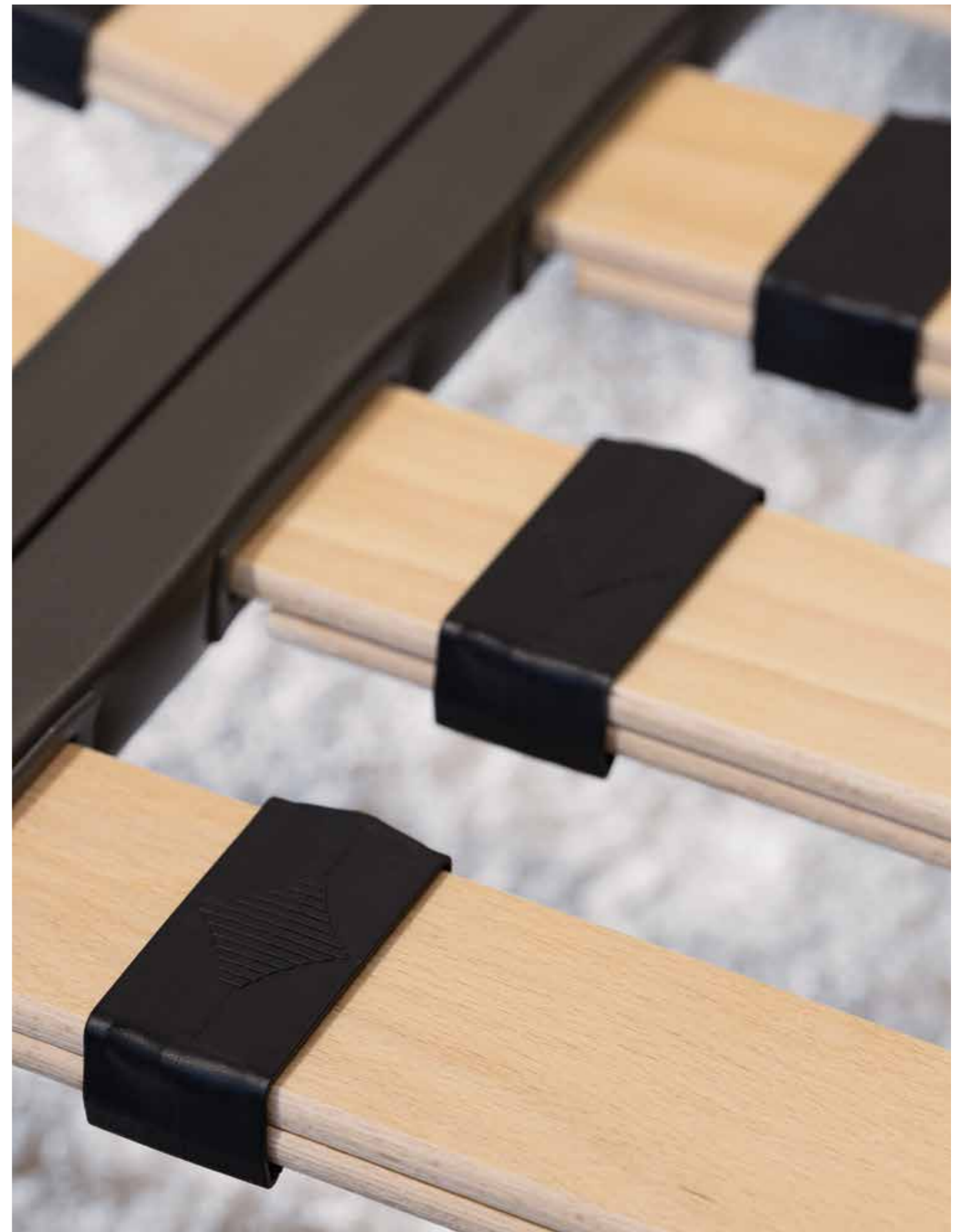



BI-WOOD

wood slatted bases

Il piano di riposo Bi-Wood è progettato per offrire un sostegno ergonomico e personalizzabile, favorendo un riposo corretto e rigenerante. Telaio e doghe in faggio multistrato con regolatori di rigidità garantiscono solidità, flessibilità e durata nel tempo, assicurando una distribuzione equilibrata del peso corporeo e un'eccellente traspirazione del materasso.

The Bi-Wood sleeping platform is designed to offer ergonomic, customisable support, promoting correct and regenerative rest. The laminated beechwood frame and slats, equipped with firmness regulators, ensure solidity, flexibility and long-lasting durability, providing balanced body weight distribution and excellent mattress breathability.



BI-WIRELESS

wireless slatted bases

Il piano di riposo motorizzato Bi-Wireless unisce la solidità delle doghe in multistrato di faggio a un comfort personalizzato. Grazie al sistema motorizzato, puoi inclinare testa e piedi con un semplice gesto, mentre i cursori lombari ti permettono di personalizzare la rigidità esattamente come desideri.

The Bi-Wireless motorised sleeping platform combines the solidity of laminated beechwood slats with personalised comfort. Thanks to the motorised system, the head and foot sections can be adjusted effortlessly, while lumbar sliders allow you to customise firmness exactly as desired.



Dotata di motore a scomparsa, senza alcun ingombro sotto il telaio, il piano di riposo Bi-Wireless è completo di telecomando Bluetooth, per un controllo facile e immediato.

Equipped with a concealed motor, with no bulk beneath the frame, the Bi-Wireless sleeping platform comes complete with a Bluetooth remote control for easy and immediate operation.

SOMMIER A INCASSO

recessed sommier

Il piano di riposo con Sommier a Incasso è costituito da due sommier a molle insacchettate, inseriti all'interno della base del letto. Questa configurazione permette di posizionare il materasso leggermente incassato, mantenendo la struttura del giroletto e garantendo stabilità e durata nel tempo.

The sleeping platform with recessed Sommier consists of two pocket-spring Sommiers housed within the bed base. This configuration allows the mattress to be positioned slightly recessed, while preserving the bed frame structure and ensuring stability and durability over time.



Struttura portante in legno massello per dare la massima robustezza; molleggio con micro molle insacchettate e gravityfoam ad alta densità altamente traspirante; imbottitura anallergica e tessuto di rivestimento brandizzato. I due sommier ad incasso sono facilmente removibili facilitando l'operazione del trasporto e del montaggio.

Supporting structure made of solid wood which gives maximum strength; micro-pocket spring and breathable high density gravityfoam; Hypoallergenic upholstery padding and custom Altrenotti covering fabric. The two recessed sommier are easily removable facilitating transport and assembly operations.



PIEDI



Frame h.7



Miniblack h.4



Black h.9



Ruo h.9

TECHNOLOGY h22

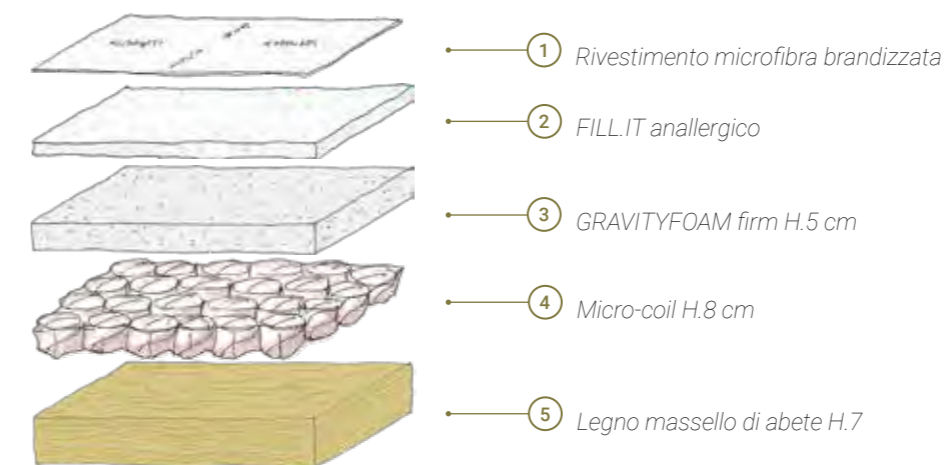

SOMMIER A FILO

flush sommier

Il piano di riposo con Sommier a Filo è costituito da un unico sommier con le molle insacchettate dove il materasso viene appoggiato sopra creando un profilo uniforme tra base e materasso ottimizzando gli spazi di ingombro del letto.

The sleeping platform with flush Sommier consists of a single pocket-spring Sommier, on which the mattress rests directly, creating a uniform profile between base and mattress and optimising the overall dimensions of the bed.



L'utilizzo delle molle insacchettate offre un sostegno puntuale e differenziato adattandosi ai carichi del corpo e garantendo un allineamento corretto della colonna vertebrale. La struttura del sommier consente un'ottimale traspirazione del materasso, riducendo l'umidità e contribuendo a un ambiente di riposo sano e confortevole.

The use of pocket springs provides targeted, differentiated support, adapting to body weight distribution and ensuring correct spinal alignment. The Sommier structure allows for optimal mattress breathability, reducing humidity and contributing to a healthy, comfortable sleeping environment.

PIEDI



TECHNOLOGY h26

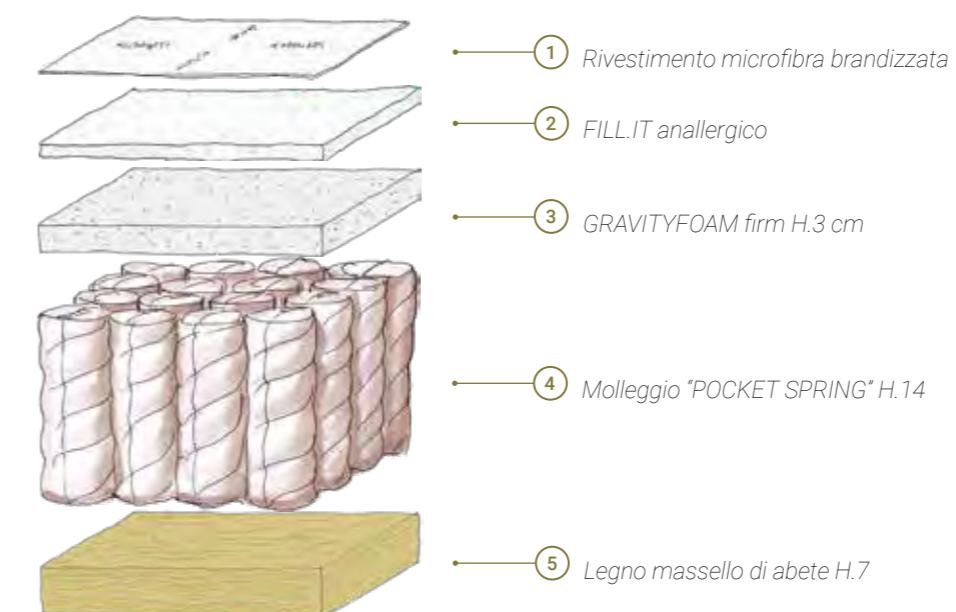



Base VELA

Le linee pulite la rendono versatile e facilmente inseribile in qualsiasi stile di arredamento.

Clean lines make it versatile and easy to integrate into any interior style.



Un equilibrio perfetto tra leggerezza e stile: la Base Vela sottile e sospesa conferisce al letto un effetto visivo di leggerezza, senza rinunciare a solidità e comfort.

A perfect balance between lightness and style: the slim, suspended Base Vela gives the bed a visual effect of lightness, without compromising solidity and comfort.

PIEDI



Stilobate h.25



Mono h.25



Cuneo h.25



Base

FANTASMA

La base del letto rientrante rispetto alla struttura esterna, ne valorizza la cornice creando un effetto di sospensione elegante che dona leggerezza all'ambiente. Il design minimale mette in risalto le linee pulite della struttura, rendendo il letto protagonista senza appesantire la stanza.

The bed base is recessed in relation to the outer structure, enhancing the frame and creating an elegant floating effect that brings lightness to the space. The minimalist design highlights the clean lines of the structure, making the bed the focal point without weighing down the room.



PIEDI



Frame h.7



Miniblack h.4



Black h.9



Ruo h.9





La Base Tradizionale dal design elegante e armonioso è caratterizzata da linee morbide e leggere che donano equilibrio e raffinatezza all'insieme. Le forme arrotondate attenuano la rigidità delle geometrie tradizionali, creando un'estetica accogliente e contemporanea.

The Base Tradizionale, with its elegant and harmonious design, is characterised by soft, light lines that bring balance and refinement to the overall composition. Rounded forms soften the rigidity of traditional geometries, creating a welcoming and contemporary aesthetic.

Base TRADIZIONALE

Il profilo discreto e le proporzioni equilibrate rendono la Base Tradizionale facilmente abbinabile a tutte le testiere della Collezione Bi-Comfort Concept Bed offrendo massima flessibilità di scelta e creando combinazioni eleganti e versatili.

Its discreet profile and balanced proportions make the Base Tradizionale easy to pair with all headboards in the Bi-Comfort Concept Bed Collection, offering maximum flexibility of choice and creating elegant, versatile combinations.



PIEDI



Frame h.7



Miniblack h.4



Black h.9



Ruo h.9





Base BAULETTO®

Un perfetto connubio di eleganza e praticità la Base Bauletto contenitore con apertura ad alzata frontale ideale per chi desidera ottimizzare lo spazio senza rinunciare allo stile.

A perfect blend of elegance and practicality, the Base Bauletto storage base with front lift opening is ideal for those who wish to optimise space without sacrificing style.



PIEDI



Frame h.7



Miniblack h.4



Black h.9



Ruo h.9





bed linen

bianchella



AIR WASH

Eleganza naturale, senza bisogno di stirare

Natural elegance, no ironing required

Grazie alla tecnologia AIR WASH, la stiratura è consentita ma non necessaria.

Le tue lenzuola in 100% cotone lavato rimangono fresche e impeccabili, pronte da utilizzare senza alcuno sforzo. La nostra biancheria AIR WASH in 100% puro cotone lavato NO STIRO è incredibilmente soffice e traspirante per un riposo rigenerante. La certificazione STANDARD 100 by OEKO-TEX garantisce che i tessuti sono privi di sostanze nocive e assicura che sono sicuri per la vostra pelle e per l'ambiente.

La gamma AIR WASH si distingue per una gamma ampia che va da toni naturali a colori vivaci che esaltano la creatività della proposta Altrenotti. Ogni tonalità è arricchita da un piping in contrasto che ne sottolinea il design accattivante e contemporaneo.

Thanks to Air Wash technology, ironing is allowed but not necessary.

Your 100% washed cotton sheets remain fresh and impeccable, ready to use without any effort.

Our AIR WASH bed linen, made from 100% pure washed cotton with a NO-IRON finish, is exceptionally soft and breathable, ensuring a truly restorative sleep.

The STANDARD 100 by OEKO-TEX® certification guarantees that the fabrics are free from harmful substances and safe for your skin and for the environment.

The Air Wash range stands out for its wide palette, ranging from natural tones to vibrant colours that enhance the creativity of the Altrenotti proposal. Each shade is enriched with contrasting piping, highlighting its appealing and contemporary design.



19 varianti con piping in contrasto



Copripiumino



Lenzuolo di sopra



Lenzuolo sottoteso
con angoli H.45
e elastico perimetrale



Coppia di federe

composizione 100% cotone lavato
thread count 152
titolo filato 30/1
finissaggio NO STIRO
altezza 280/290 cm
peso 124 gr/mq

istruzioni di lavaggio

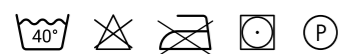

utilizzare detersivi neutri

OEKO-TEX®
CONFIDENCE IN TEXTILES



bianco ottico con piping beige



panna con piping oliva



beige con piping blu



ghiaccio con piping viola



grigio con piping blu



basalto con piping panna



certosino con piping acqua



cincillà con piping rosa



cielo con piping blu



acqua con piping beige



blu con piping grigio



blu navy con piping oliva



viola con piping oliva



rosa con piping tortora



orange con piping blu navy



senape con piping bianco



oliva con piping cielo



caffè con piping cielo



carbone con piping ghiaccio



LINO BROUGES

fibre pregiate, traspirabilità e comfort
per un riposo autentico e naturale

*Premium fibres, breathability and comfort for
an authentic, natural rest*

Scopri il fascino senza tempo della Collezione Lino Brouges, sinonimo di eleganza naturale e morbidezza straordinaria. Perfetta per chi ama un tocco di raffinatezza nella propria camera da letto, realizzata con fibre di lino di alta qualità, la nostra biancheria è resistente, traspirante e delicata sulla pelle. Il suo aspetto leggermente strutturato e la naturale brillantezza donano un effetto sofisticato, disponibile nelle delicate tonalità avorio, ostrica e wafer, un'atmosfera accogliente e raffinata.

Discover the timeless charm of the Lino Brouges Collection, a synonym for natural elegance and exceptional softness. Perfect for those who appreciate a refined touch in the bedroom, this bed linen is crafted from high-quality linen fibres, offering durability, breathability and a gentle feel on the skin. Its subtly textured appearance and natural sheen create a sophisticated effect, available in delicate shades of ivory, oyster and wafer, for a welcoming and refined atmosphere.

3 varianti



Copripiumino



Lenzuolo di sopra



Lenzuolo sottoteso con angoli H.45 e elastico perimetrale



Coppia di federe

composizione 100% lino
 thread count 115
 titolo filato 60/1
 altezza 290 cm
 peso 180 gr/mq

istruzioni di lavaggio

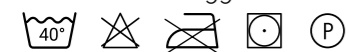

VARIANTI COLORATE

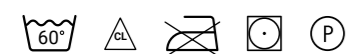

BIANCO OTTICO, BIANCO NATURALE, AVORIO e OSTRICA

utilizzare detersivi neutri

OEKO-TEX®
 CONFIDENCE IN TEXTILES



avorio



wafer



ostrica





CAREZZA

la delicatezza del raso, la dolcezza del riposo

The delicacy of sateen, the sweetness of rest

Regalati il lusso di un riposo raffinato con la nostra biancheria Carezza in raso 100% puro cotone mercerizzato, pensata per chi desidera un letto elegante e confortevole. Il tessuto, morbido e luminoso, avvolge la pelle con una sensazione setosa, grazie all'effetto soft touch che rende ogni contatto un'esperienza di puro benessere. Il cotone mercerizzato non solo dona al tessuto una naturale lucentezza, ma ne aumenta la resistenza, garantendo durata nel tempo senza perdere morbidezza e fascino. Proposta in 14 varianti colore dal bianco naturale, all'ostrica, al beige arricchita da diverse sfumature di grigi, verdi e rosa per adattarsi armoniosamente a ogni camera da letto.

Treat yourself to the luxury of refined rest with our Carezza bed linen, made from 100% pure mercerised cotton sateen, designed for those who seek an elegant and comfortable bed. The fabric, soft and luminous, envelops the skin with a silky sensation thanks to its soft-touch effect, turning every contact into an experience of pure wellbeing. Mercerised cotton not only enhances the fabric's natural lustre, but also increases its durability, ensuring long-lasting performance without losing softness or appeal. Available in 14 colour options, ranging from natural white to oyster and beige, enriched with multiple shades of grey, green and pink, to harmonise effortlessly with any bedroom.

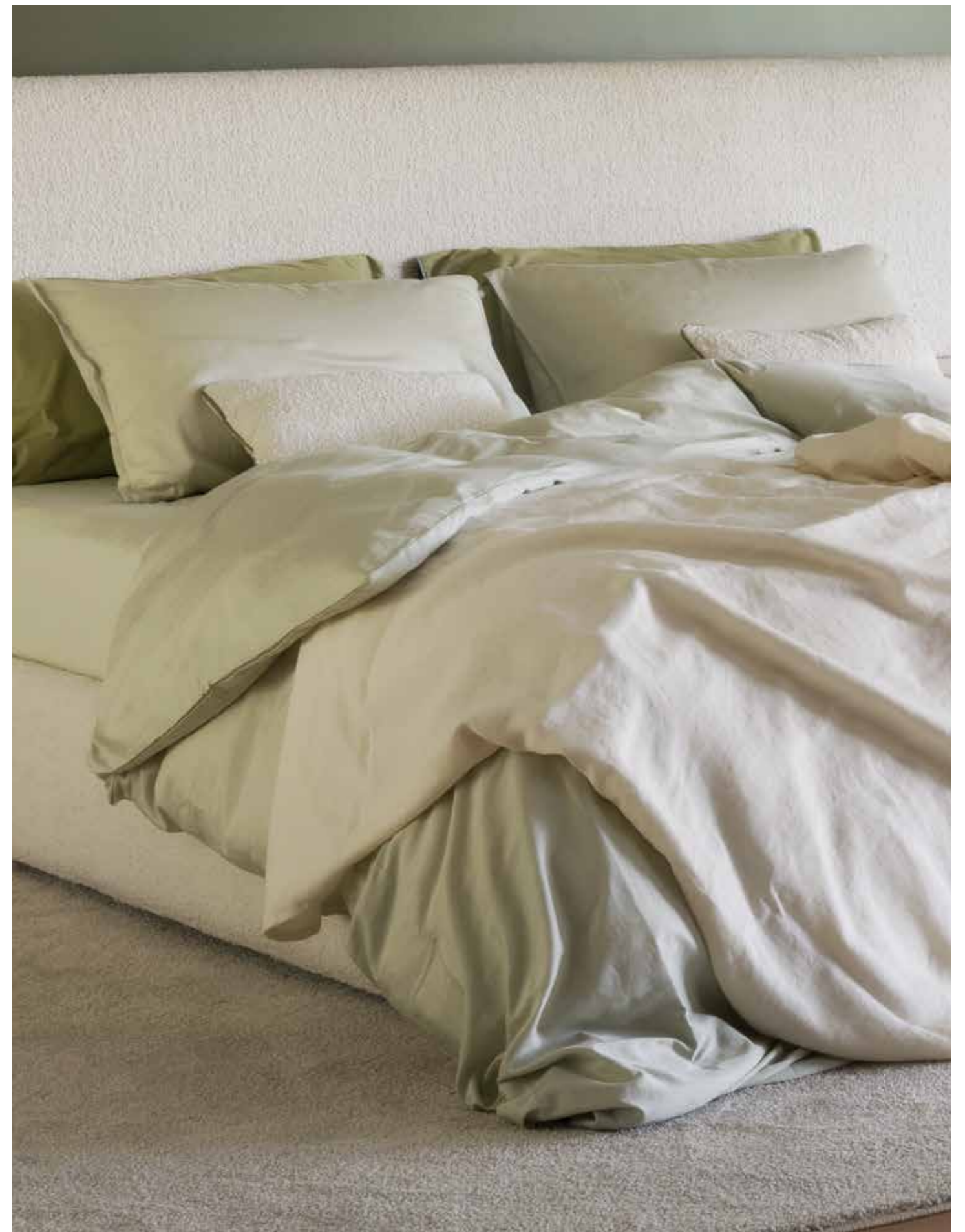

14 varianti



Copripiumino



Lenzuolo di sopra



Lenzuolo sottoteso
con angoli H.45
e elastico perimetrale



Coppia di federe

tipologia **satin**
 composizione **100% cotone lavato**
 thread count **300**
 altezza **300 cm**
 peso **115 gr/mq**
 finissaggio **NO STIRO**

istruzioni di lavaggio

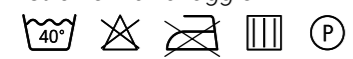

ALBERO, BIANCO NATURALE, OSTRICA

utilizzare detersivi neutri



cipolla



margot



tundra



aereo



gelido



albero



braid blu



beach



grisaglia



ostrica



estadio



damar



bianco naturale



caramel

OEKO-TEX®
 CONFIDENCE IN TEXTILES



SATIN UNITO

la purezza del satin
per un comfort impeccabile

The purity of satin for impeccable comfort

Porta nel tuo letto un tocco di lusso e raffinatezza con la nostra Collezione Satin Unito in satin di cotone 300 TC, creata per offrire morbidezza, lucentezza e comfort superiori. La collezione è disponibile in sei sofisticate varianti colore: Unito Ostrica, Bianco Ottico, Titanio, Cipolla, Tiffany e Blu Navy, perfette per armonizzarsi con qualsiasi ambiente. Personalizzala con un elegante ricamo a cordonetto sulle federe e sul lenzuolo sopra, aggiungendo un dettaglio esclusivo. Scegli la tonalità e il ricamo che riflettono il tuo gusto, creando un'atmosfera unica e armoniosa nella tua camera da letto, dove ogni dettaglio contribuisce a rendere lo spazio più raffinato e accogliente.

Bring a touch of luxury and refinement to your bed with our Satin Unito Collection, crafted from 300 TC cotton satin to deliver superior softness, sheen and comfort. The collection is available in six sophisticated colourways: Unito Ostrica, Bianco Ottico, Titanio, Cipolla, Tiffany and Blu Navy, perfectly suited to complement any interior. Personalise it with elegant corded embroidery on pillowcases and top sheets, adding an exclusive detail. Choose the shade and embroidery that best reflect your style, creating a unique and harmonious bedroom atmosphere where every detail contributes to a more refined and welcoming space.

6 varianti



Copripiumino



Lenzuolo sopra



Lenzuolo sopra
con ricamo cordonetto



Lenzuolo sottoteso
con angoli H.45
e elastico perimetrale



Coppia di federe



Coppia di federe
con ricamo cordonetto



Satin Unito Ostrica



Satin Unito Bianco ottico



Satin Unito Tiffany



Satin Unito Blu navy



Satin Unito Titanio



Satin Unito Cipolla



Satin Unito Ostrica
ricamo cordonetto ostrica



Satin Unito Bianco ottico
ricamo cordonetto titanio



Satin Unito Tiffany
ricamo cordonetto tiffany



Satin Unito Blu navy
ricamo cordonetto blu navy



Satin Unito Titanio
ricamo cordonetto titanio



Satin Unito Cipolla
ricamo cordonetto cipolla

tipologia satin
composizione 100% cotone lavato
thread count 300
altezza 300 cm
peso 115 gr/mq

istruzioni di lavaggio



BIANCO NATURALE

utilizzare detersivi neutri

OEKO-TEX®
CONFIDENCE IN TEXTILES



SATIN JACQUARD

trame preziose
per un'eleganza senza tempo

Precious weaves for timeless elegance

Scopri la raffinatezza artistica del satin jacquard 100% cotone, dove ogni dettaglio è curato per un comfort senza compromessi. La trama jacquard crea motivi che ricordano delicate pennellate, conferendo al tessuto una texture sofisticata e un effetto visivo elegante e leggermente tridimensionale. Le federe e la sacca copripiumino con ricamo cordonetto in tinta, realizzate con un lato in satin jacquard e un lato in satin tinta unita, avvolgono il letto in un'atmosfera di raffinata eleganza e armonia discreta, trasformando ogni notte in un'esperienza di puro benessere.

Discover the artistic refinement of 100% cotton satin jacquard, where every detail is carefully crafted to deliver uncompromising comfort. The jacquard weave creates patterns reminiscent of delicate brushstrokes, giving the fabric a sophisticated texture and an elegant, subtly three-dimensional visual effect. The pillowcases and duvet cover bag, featuring tone-on-tone corded embroidery and crafted with one side in satin jacquard and the other in plain satin, envelop the bed in an atmosphere of refined elegance and discreet harmony, transforming every night into an experience of pure wellbeing.



6 varianti



Sacca



Lenzuolo di sopra



Lenzuolo sottoteso
con angoli H.45
e elastico perimetrale



Coppia di federe



Jacquard Tiffany
ricamo cordonetto tiffany



Jacquard Titanio
ricamo cordonetto titanio



Jacquard Blu navy
ricamo cordonetto blu navy



Jacquard Ostrica
ricamo cordonetto ostrica



Jacquard Bianco ottico
ricamo cordonetto
bianco ottico



Jacquard Cipolla
ricamo cordonetto cipolla

tipologia Satin jacquard
composizione 100% cotone lavato
thread count 300
altezza 300 cm
peso 115 gr/mq

istruzioni di lavaggio

BIANCO NATURALE
 utilizzare detersivi neutri

OEKO-TEX®
CONFIDENCE IN TEXTILES



TEXTURE

colori, disegni e sensazioni che raccontano te

Colours, patterns and sensations that tell your story

Aggiungi eleganza e personalità al tuo letto con la nostra Collezione biancheria Texture in raso stampato, dove motivi geometrici e floreali si intrecciano con armonia, creando un design raffinato e contemporaneo. Le federe e il copripiumino sono realizzati con un lato in raso con texture stampata e un lato in satin tinta unita, offrendo la possibilità di combinare i diversi lati e giocare con lo stile del letto secondo il tuo gusto personale. Il raso, morbido e lucente, garantisce un comfort elegante e una sensazione di lusso ad ogni tocco, trasformando il letto in un vero e proprio protagonista della camera da letto. Con questa biancheria puoi esprimere la tua creatività e personalità, creando abbinamenti unici che rendono l'ambiente accogliente, sofisticato e del tutto personale.

Add elegance and personality to your bed with our Texture bed linen collection in printed sateen, where geometric and floral motifs intertwine harmoniously to create a refined, contemporary design. The pillowcases and duvet cover bag are made with one side in printed sateen texture and the other in plain satin, offering the freedom to combine the two sides and play with the style of the bed according to your personal taste. The sateen fabric, soft and luminous, ensures elegant comfort and a luxurious feel at every touch, turning the bed into a true focal point of the bedroom. With this bed linen, you can express your creativity and personality, creating unique combinations that make the space welcoming, sophisticated and truly your own.

16 varianti



Copripiumino



Lenzuolo di sopra



Lenzuolo sottoteso
con angoli H.45
e elastico perimetrale



Coppia di federe



kenzia 01



kenzia 02



giglio 02



giglio 01



chelsea 02



chelsea 01



manhattan 02



manhattan 01



brooklyn 01



wall 02



wall 01



soho 01



tribeca 02



tribeca 03



jazz 02



jazz 01

tipologia Satin stampato
composizione 100% cotone
thread count 300
titolo filato 60/1 pettinato
resistenza pilling 4/5
altezza 305 cm
peso 110gr/mq

istruzioni di lavaggio

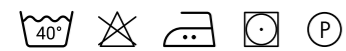

utilizzare detersivi neutri

OEKO-TEX®
CONFIDENCE IN TEXTILES



customizations

personalizzazioni

• pelle



- massello noce canaletto
- massello frassino nero
- massello frassino wengé



personalizza la tua testiera: calore del legno, eleganza della pelle

*Customise your headboard:
the warmth of wood, the elegance of leather*

Rendi unico il tuo letto scegliendo la soluzione che meglio riflette il tuo stile e le tue esigenze. La testiera può essere personalizzata con mensole o eleganti inserti in legno, disponibili in noce canaletto, frassino finitura nera o wengé oppure rivestiti in pelle per un tocco naturale e raffinato che valorizza ogni camera da letto.

Make your bed truly unique by choosing the solution that best reflects your style and needs. The headboard can be customised with elegant wood inserts or shelves, available in Canaletto walnut, black-stained ash or wengé, or upholstered in leather for a natural, refined touch that enhances any bedroom.



personalizza la tua testiera: prese elettriche

*Customise your headboard:
electrical outlets*

Le testiere Alba Long e Alba Voler uniscono design e funzionalità, offrendo la possibilità di integrare prese elettriche, USB e punti luce direttamente nella struttura. Una soluzione su misura che valorizza l'estetica della camera e garantisce il massimo comfort, rendendo semplice la ricarica dei dispositivi e l'utilizzo di lampade da lettura, senza cavi a vista.

The Alba Long and Alba Voler headboards combine design and functionality, offering the option to integrate electrical sockets, USB ports and lighting points directly into the structure. A bespoke solution that enhances the bedroom's aesthetics while ensuring maximum comfort, making it easy to charge devices and use reading lights—without visible cables.





technical drawings
disegni tecnici

ALBA LONG

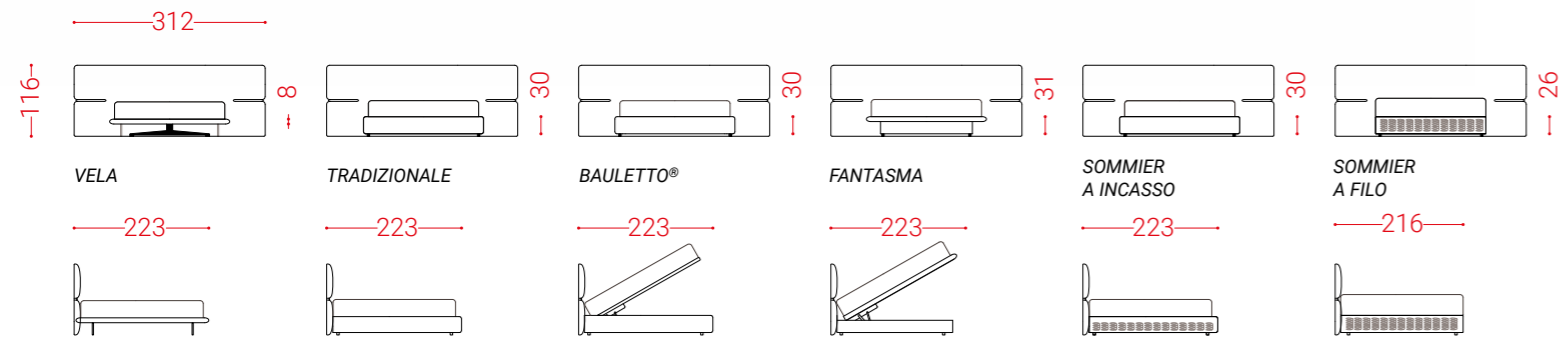

MATERASSO	VELA	TRADIZIONALE	BAULETTO®	FANTASMA	SOMMIER A INCASSO	SOMMIER A FILO
matrimoniale 160 X 190 - 200			292 X 213 - 223 115" x 83 7/8" - 87 3/4"			292 X 206 - 216 115" x 81 1/8" - 85"
king size 180 X 200			312 X 223 122 7/8" x 87 3/4"			312 X 216 122 7/8" x 85"
extra king size 200 X 200			332 X 223 130 3/4" x 87 3/4"			332 X 216 130 3/4" x 85"
U.S. queen size 152 X 203			292 X 226 115" x 89"			292 X 219 115" x 86 1/4"
U.S. king size 193 X 203			332 X 226 130 3/4" x 89"			332 X 219 130 3/4" x 86 1/4"

ALBA VOLER

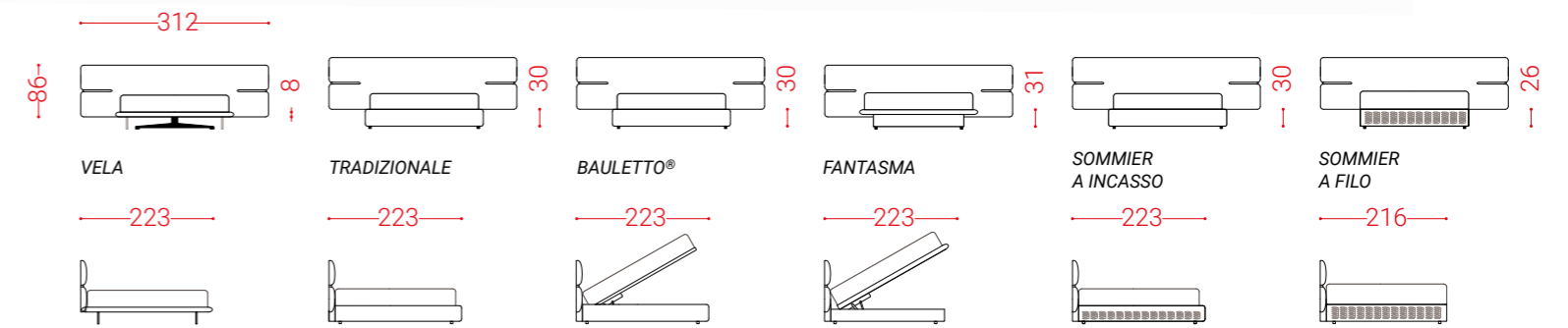

MATERASSO	VELA	TRADIZIONALE	BAULETTO®	FANTASMA	SOMMIER A INCASSO	SOMMIER A FILO
matrimoniale 160 X 190 - 200			292 X 213 - 223 115" x 83 7/8" - 87 3/4"			292 X 206 - 216 115" x 81 1/8" - 85"
king size 180 X 200			312 X 223 122 7/8" x 87 3/4"			312 X 216 122 7/8" x 85"
extra king size 200 X 200			332 X 223 130 3/4" x 87 3/4"			332 X 216 130 3/4" x 85"
U.S. queen size 152 X 203			292 X 226 115" x 89"			292 X 219 115" x 86 1/4"
U.S. king size 193 X 203			332 X 226 130 3/4" x 89"			332 X 219 130 3/4" x 86 1/4"

ALBA MOYEN

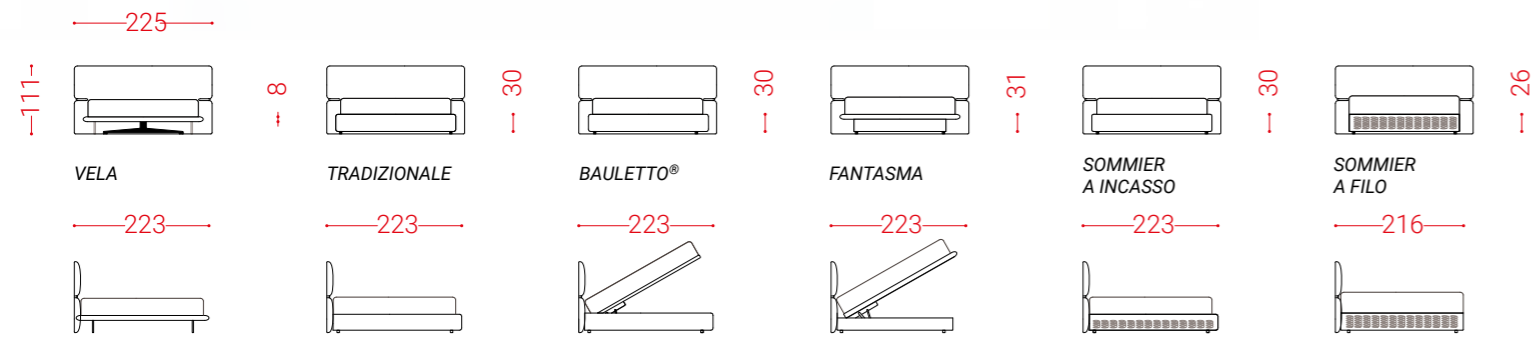

MATERASSO	VELA	TRADIZIONALE	BAULETTO®	FANTASMA	SOMMIER A INCASSO	SOMMIER A FILO
matrimoniale 160 X 190 - 200			205 X 213 - 223 80 3/4" x 83 7/8" - 87 3/4"			205 X 206 - 216 80 3/4" x 81 1/8" - 85"
king size 180 X 200			225 X 223 88 5/8" x 87 3/4"			225 X 216 88 5/8" x 85"
extra king size 200 X 200			245 X 223 96 1/2" x 87 3/4"			245 X 216 96 1/2" x 85"
U.S. queen size 152 X 203			205 X 226 80 3/4" x 89"			205 X 219 80 3/4" x 86 1/4"
U.S. king size 193 X 203			245 X 226 96 1/2" x 89"			245 X 219 96 1/2" x 86 1/4"

ALBA PETIT

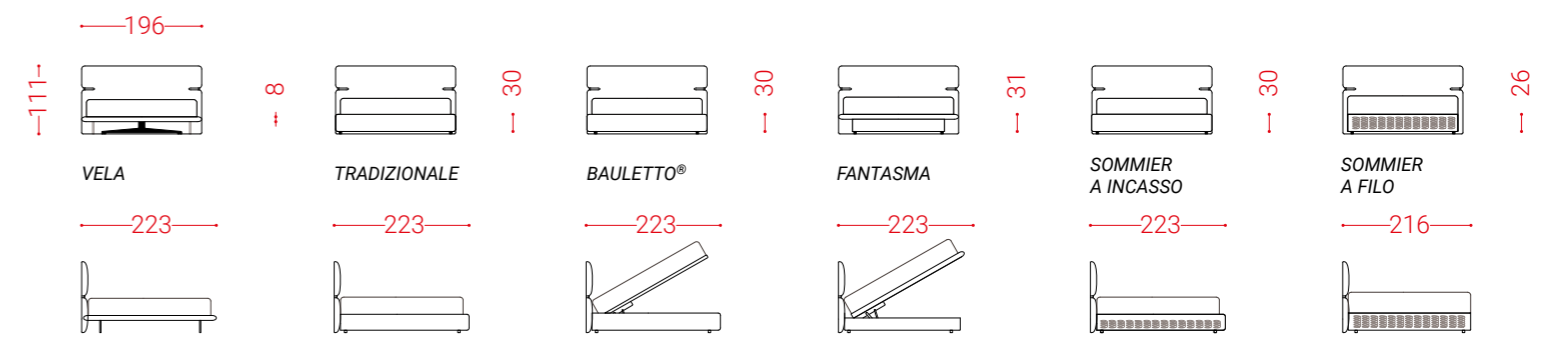

MATERASSO	VELA	TRADIZIONALE	BAULETTO®	FANTASMA	SOMMIER A INCASSO	SOMMIER A FILO
matrimoniale 160 X 190 - 200			176 X 213 - 223 69 1/4" x 83 7/8" - 87 3/4"			176 X 206 - 216 69 1/4" x 81 1/8" - 85"
king size 180 X 200			196 X 223 77 1/8" x 87 3/4"			196 X 216 77 1/8" x 85"
extra king size 200 X 200			216 X 223 85" x 87 3/4"			216 X 216 85" x 85"
U.S. queen size 152 X 203			176 X 226 69 1/4" x 89"			176 X 219 69 1/4" x 86 1/4"
U.S. king size 193 X 203			216 X 226 85" x 89"			216 X 219 85" x 86 1/4"

ALBA HAUTE

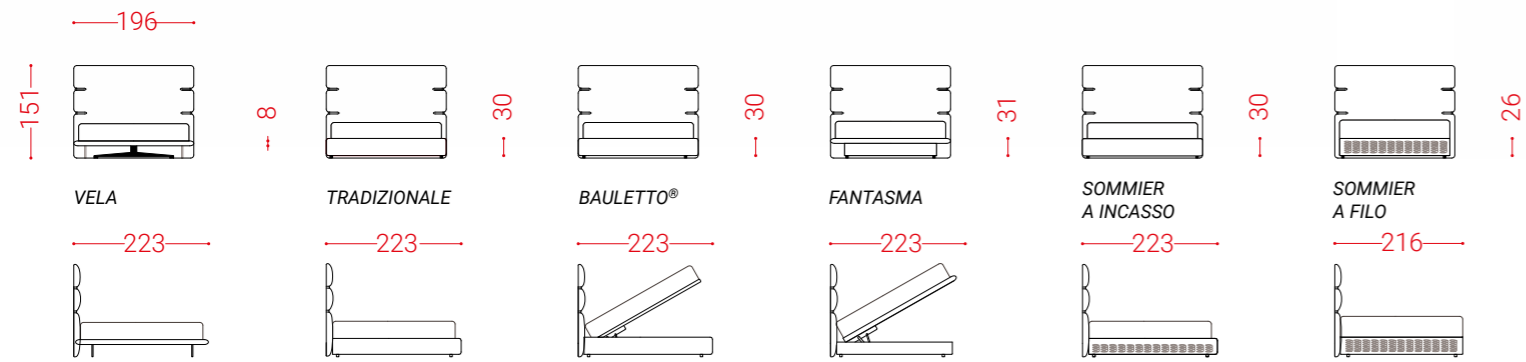

MATERASSO	VELA	TRADIZIONALE	BAULETTO®	FANTASMA	SOMMIER A INCASSO	SOMMIER A FILO
matrimoniale 160 X 190 - 200			176 X 213 - 223 69 1/4" x 83 7/8" - 87 3/4"			176 X 206 - 216 69 1/4" x 81 1/8" - 85"
king size 180 X 200			196 X 223 77 1/8" x 87 3/4"			196 X 216 77 1/8" x 85"
extra king size 200 X 200			216 X 223 85" x 87 3/4"			216 X 216 85" x 85"
U.S. queen size 152 X 203			176 X 226 69 1/4" x 89"			176 X 219 69 1/4" x 86 1/4"
U.S. king size 193 X 203			216 X 226 85" x 89"			216 X 219 85" x 86 1/4"

MONFORTE

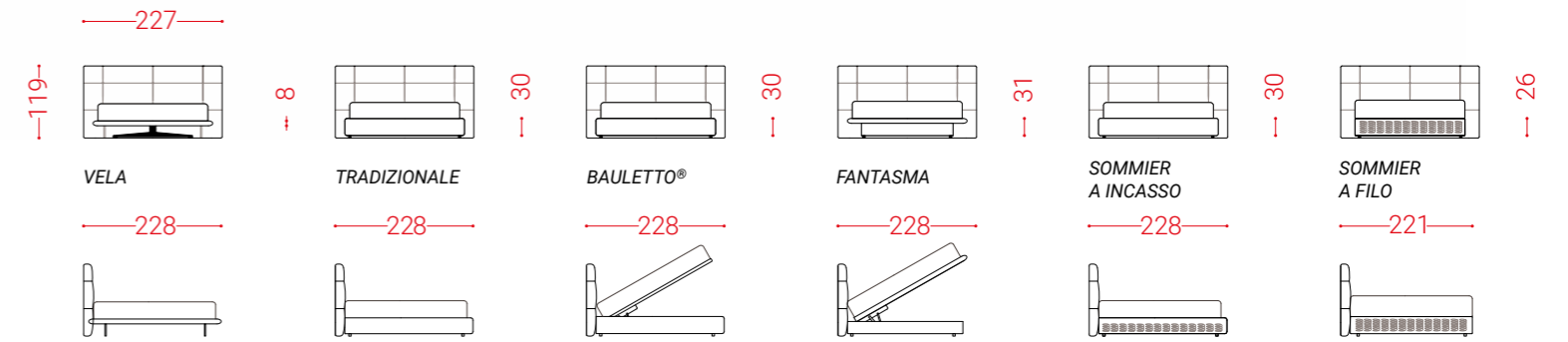

MATERASSO	VELA	TRADIZIONALE	BAULETTO®	FANTASMA	SOMMIER A INCASSO	SOMMIER A FILO
matrimoniale 160 X 190 - 200			207 X 218 - 228 81 1/2" x 85 3/4" - 89 3/4"			207 X 211 - 221 81 1/2" x 83 1/8" - 87"
king size 180 X 200			227 X 228 89 1/2" x 89 3/4"			227 X 221 89 1/2" x 87"
extra king size 200 X 200			247 X 228 97 1/4" x 89 3/4"			247 X 221 97 1/4" x 87"
U.S. queen size 152 X 203			207 X 231 81 1/2" x 91"			207 X 224 81 1/2" x 88 1/4"
U.S. king size 193 X 203			247 X 231 97 1/4" x 91"			247 X 224 97 1/4" x 88 1/4"

RODDI

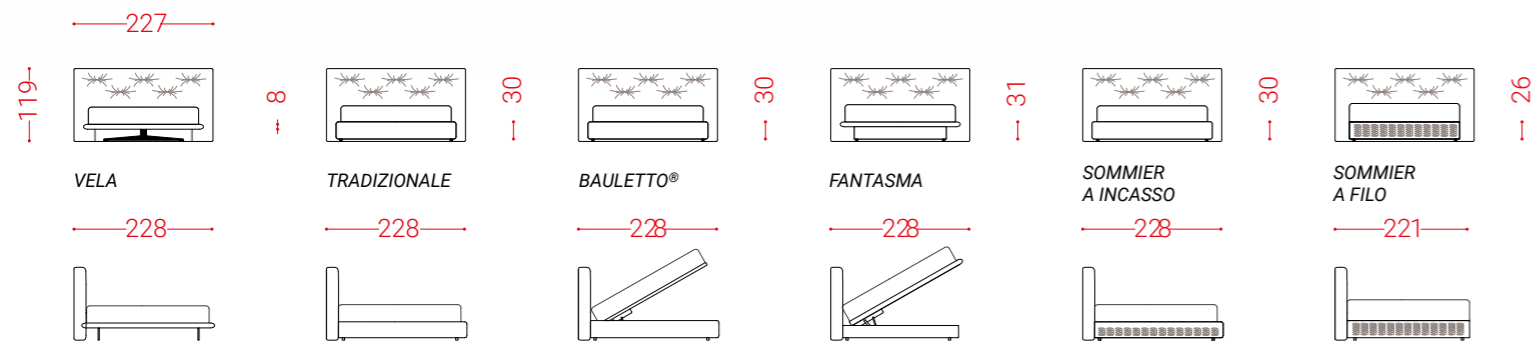

MATERASSO	VELA	TRADIZIONALE	BAULETTO®	FANTASMA	SOMMIER A INCASSO	SOMMIER A FILO
matrimoniale 160 X 190 - 200			207 X 218 - 228 81 1/2" x 85 3/4" - 89 3/4"			207 X 211 - 221 81 1/2" x 83 1/8" - 87"
king size 180 X 200			227 X 228 89 1/2" x 89 3/4"			227 X 221 89 1/2" x 87"
extra king size 200 X 200			247 X 228 97 1/4" x 89 3/4"			247 X 221 97 1/4" x 87"
U.S. queen size 152 X 203			207 X 231 81 1/2" x 91"			207 X 224 81 1/2" x 88 1/4"
U.S. king size 193 X 203			247 X 231 97 1/4" x 91"			247 X 224 97 1/4" x 88 1/4"

ROERO

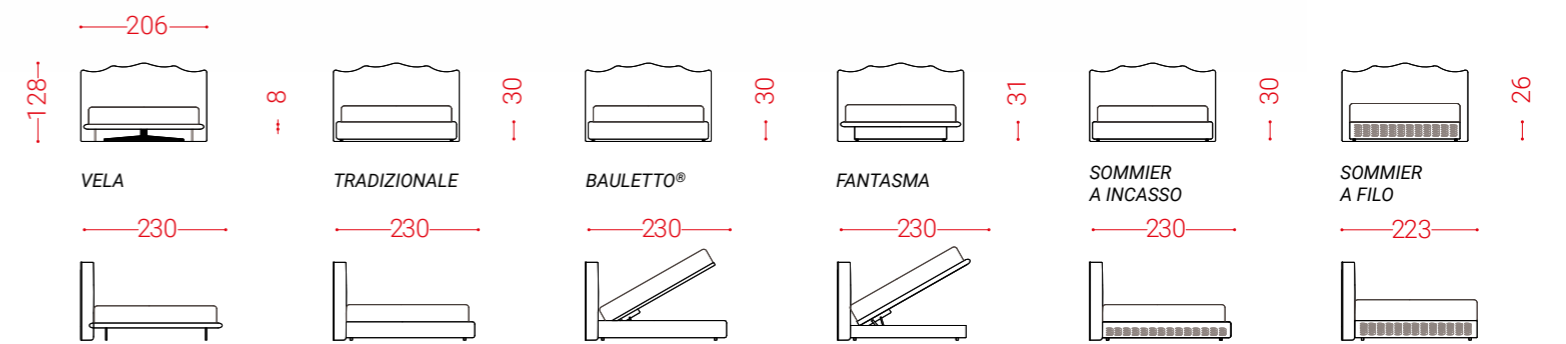

MATERASSO	VELA	TRADIZIONALE	BAULETTO®	FANTASMA	SOMMIER A INCASSO	SOMMIER A FILO
matrimoniale 160 X 190 - 200			186 X 220 - 230 73 1/4" x 86 5/8" - 90 1/2"			186 X 213 - 223 73 1/4" x 83 7/8" - 87 3/4"
king size 180 X 200			206 X 230 81 1/8" x 90 1/2"			206 X 223 81 1/8" x 87 3/4"
extra king size 200 X 200			226 X 230 89" x 90 1/2"			226 X 223 89" x 87 3/4"
U.S. queen size 152 X 203			186 X 233 73 1/4" x 91 3/4"			186 X 226 73 1/4" x 89"
U.S. king size 193 X 203			226 X 233 89" x 91 3/4"			226 X 226 89" x 89"

BARBARESCO

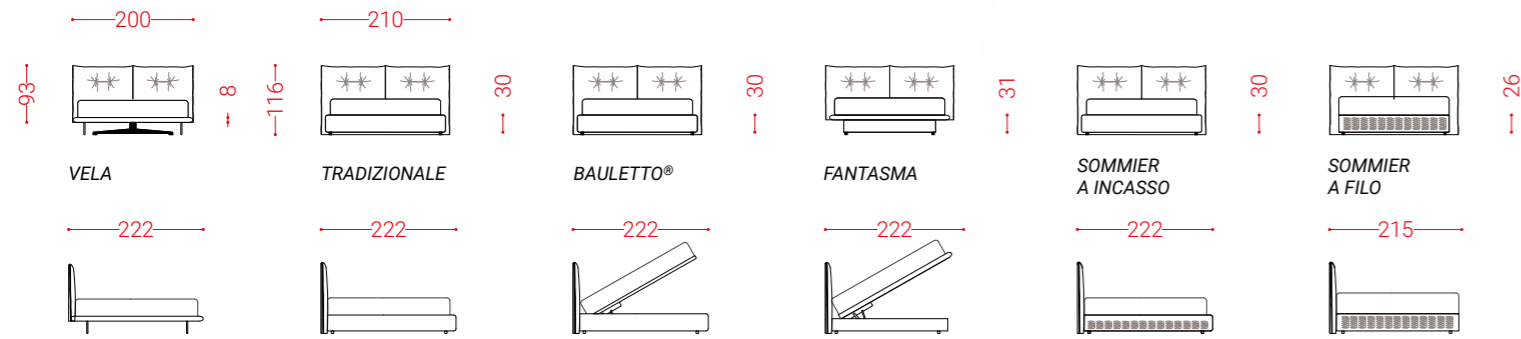

MATERASSO	VELA	TRADIZIONALE	BAULETTO®	FANTASMA	SOMMIER A INCASSO	SOMMIER A FILO
matrimoniale 160 X 190 - 200	180 X 212 - 222 70 7/8" x 83 1/2" - 87 3/8"		190 X 212 - 222 74 3/4" x 83 1/2" - 87 3/8"			190 X 205 - 215 4 3/4" x 80 3/4" - 84 5/8"
king size 180 X 200	200 X 222 78 3/4" x 87 3/8"		210 X 222 82 5/8" x 87 3/8"			210 X 215 82 5/8" x 84 5/8"
extra king size 200 X 200	220 X 222 86 5/8" x 87 3/8"		230 X 222 90 1/2" x 87 3/8"			230 X 215 90 1/2" x 84 5/8"
U.S. queen size 152 X 203	180 X 225 70 7/8" x 88 5/8"		190 X 225 74 3/4" x 88 5/8"			190 X 218 74 3/4" x 85 7/8"
U.S. king size 193 X 203	220 X 225 86 5/8" x 88 5/8"		230 X 225 90 1/2" x 88 5/8"			230 X 218 90 1/2" x 85 7/8"

NEIVE

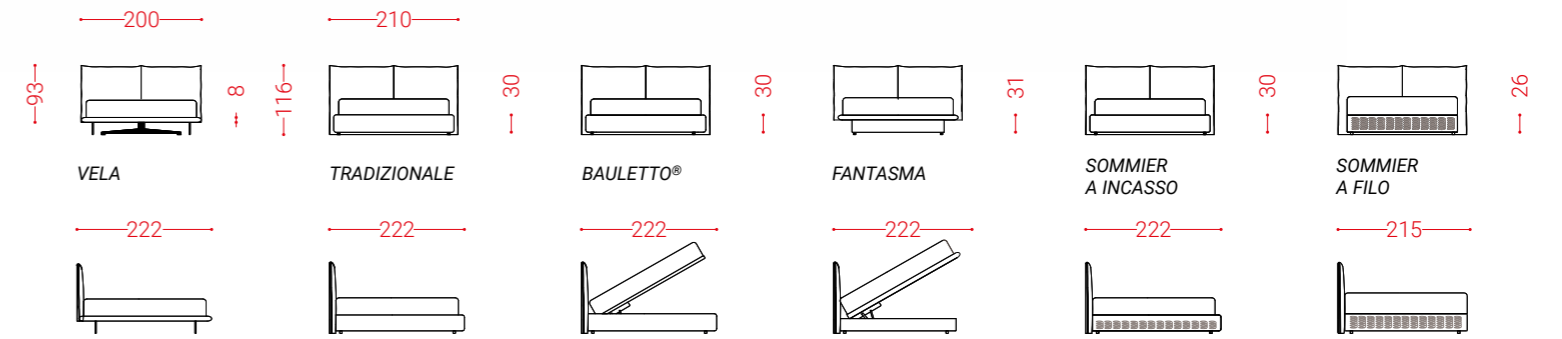

MATERASSO	VELA	TRADIZIONALE	BAULETTO®	FANTASMA	SOMMIER A INCASSO	SOMMIER A FILO
matrimoniale 160 X 190 - 200	180 X 212 - 222 70 7/8" x 83 1/2" - 87 3/8"		190 X 212 - 222 74 3/4" x 83 1/2" - 87 3/8"			190 X 205 - 215 4 3/4" x 80 3/4" - 84 5/8"
king size 180 X 200	200 X 222 78 3/4" x 87 3/8"		210 X 222 82 5/8" x 87 3/8"			210 X 215 82 5/8" x 84 5/8"
extra king size 200 X 200	220 X 222 86 5/8" x 87 3/8"		230 X 222 90 1/2" x 87 3/8"			230 X 215 90 1/2" x 84 5/8"
U.S. queen size 152 X 203	180 X 225 70 7/8" x 88 5/8"		190 X 225 74 3/4" x 88 5/8"			190 X 218 74 3/4" x 85 7/8"
U.S. king size 193 X 203	220 X 225 86 5/8" x 88 5/8"		230 X 225 90 1/2" x 88 5/8"			230 X 218 90 1/2" x 85 7/8"

LA MORRA

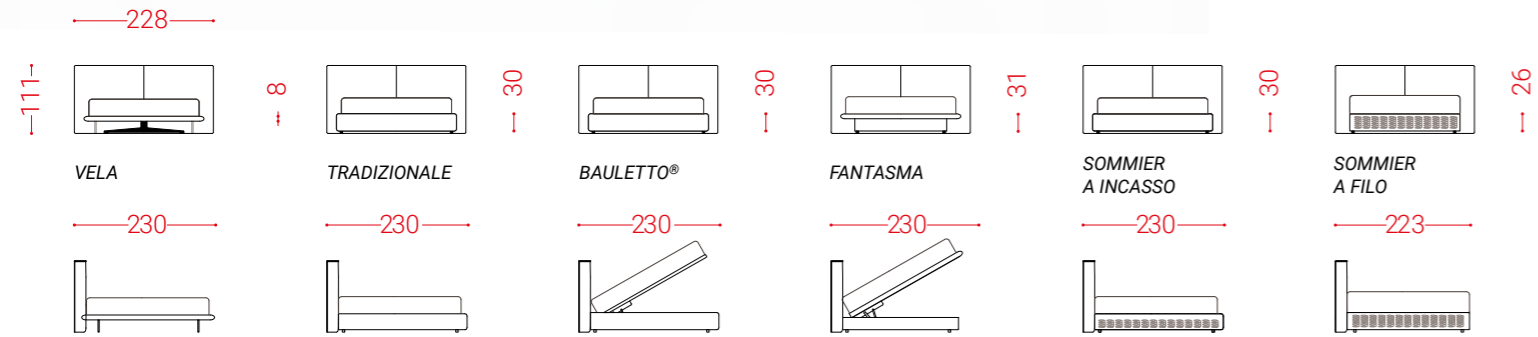

MATERASSO	VELA	TRADIZIONALE	BAULETTO®	FANTASMA	SOMMIER A INCASSO	SOMMIER A FILO
matrimoniale 160 X 190 - 200			208 X 220 - 230 81 7/8" x 86 5/8" - 90 1/2"			208 X 213 - 223 81 7/8" x 83 7/8" - 87 3/4"
king size 180 X 200			228 X 230 89 3/4" x 90 1/2"			228 X 223 89 3/4" x 87 3/4"
extra king size 200 X 200			248 X 230 97 5/8" x 90 1/2"			248 X 223 97 5/8" x 87 3/4"
U.S. queen size 152 X 203			208 X 233 81 7/8" x 91 3/4"			208 X 226 81 7/8" x 89"
U.S. king size 193 X 203			248 X 233 97 5/8" x 91 3/4"			248 X 226 97 5/8" x 89"

LILY

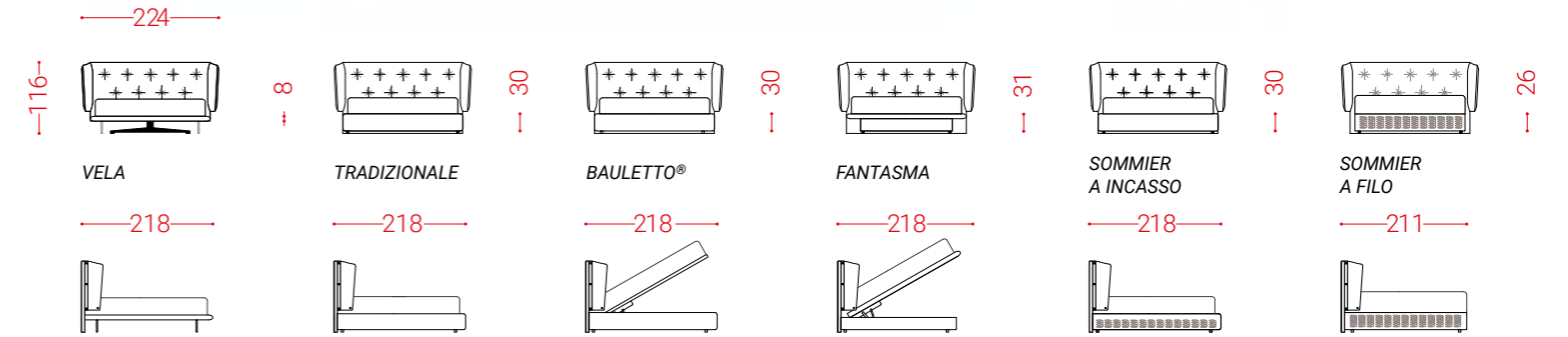

MATERASSO	VELA	TRADIZIONALE	BAULETTO®	FANTASMA	SOMMIER A INCASSO	SOMMIER A FILO
matrimoniale 160 X 190 - 200			204 X 208 - 218 80 1/4" x 81 7/8" - 85 7/8"			204 X 191 - 211 80 1/4" x 75 1/4" - 83 1/8"
king size 180 X 200			224 X 218 88 1/4" x 85 7/8"			224 X 211 88 1/4" x 83 1/8"
extra king size 200 X 200			244 X 218 96 1/8" x 85 7/8"			244 X 211 96 1/8" x 83 1/8"
U.S. queen size 152 X 203			204 X 221 80 1/4" x 87"			204 X 214 80 1/4" x 84 1/4"
U.S. king size 193 X 203			244 X 221 96 1/8" x 87"			244 X 214 96 1/8" x 84 1/4"

SOMMIER 4 LATI

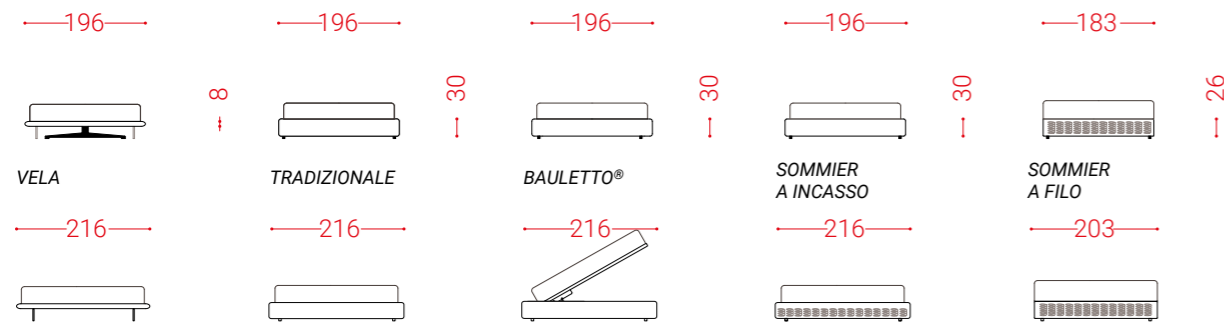

MATERASSO	VELA	TRADIZIONALE	BAULETTO®	SOMMIER A INCASSO	SOMMIER A FILO
matrimoniale 160 X 190 - 200		176 x 206 - 216 69 1/4" x 81 1/8" - 85"			163 X 193 - 203 64 1/8" x 76" - 79 7/8"
king size 180 X 200		196 x 216 77 1/8" x 85"			183 X 203 72" x 79 7/8"
extra king size 200 X 200		216 x 216 85" x 85"			203 X 203 79 7/8" x 79 7/8"
U.S. queen size 152 X 203		168 x 219 66 1/8" x 86 1/4"			155 X 206 61" x 81 1/8"
U.S. king size 193 X 203		209 x 219 82 1/4" x 86 1/4"			196 X 206 77 1/8" x 81 1/8"

ALBA BERGÈRE

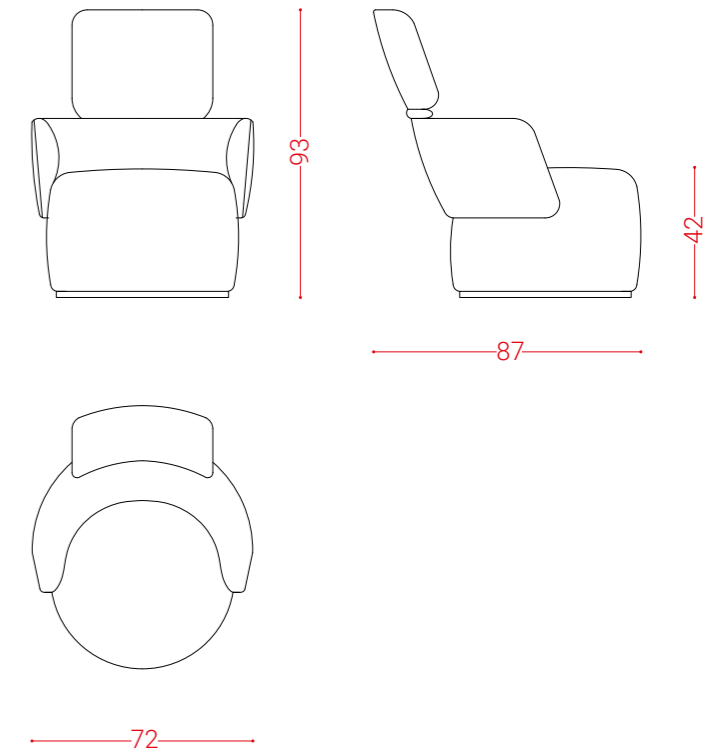

ALBA POLTRONCINA

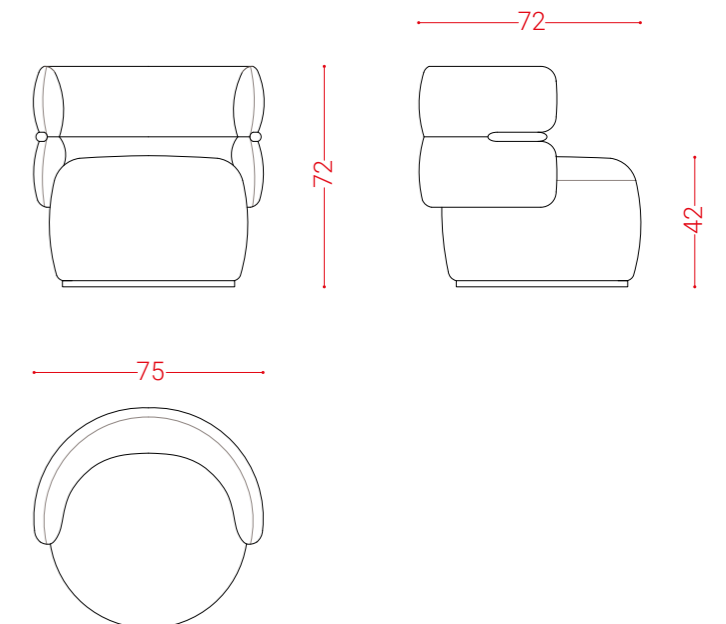

® Altrenotti

est. 1930

Absolutely Italian Goods s.p.a.
via Degli Artigiani, 2
10017 Montanaro (TO) Italy
tel. +39 011 9193570

Customer Italia: commerciale@altrenotti.it
Ordini Italia: ordini.italia@altrenotti.it
Export Department: export@altrenotti.it

Follow us

@altrenottiofficial



www.altrenotti.it

scopri tutti dettagli sul sito
scan QR- Code



*Altrenotti realizza tutte le sue collezioni in Italia
usando componenti e materie prime selezionate.*

*Altrenotti creates its collections in Italy using
selected components and raw materials.*

*L'azienda si riserva di apportare modifiche che
ritiene più opportune ai prodotti, in qualsiasi
momento e senza preavviso e vieta ogni
riproduzione totale o parziale in Italia e all'estero.*

*Altrenotti reserves the right to modify models
without any previous notice and it any time.
Total or partial reproduction is prohibited in Italy
or any other countries.*

Printed in Italy, 2026

® Altrenotti
est. 1930

www.altrenotti.it

