

# Artemide®



2026

A

Artemide outlines  
the perspective of light  
to design  
the future in the present.

Artemide merges  
creativity and measure,  
knowledge and know-how.

Ernesto Gismondi  
built this path  
in 1959.



# Iperbole BIG - Bjarke Ingels Group

"In math class, we learned that when you cut a geometric cone, you reveal a hyperbola. That simple operation of sectioning a pure form forms the foundation of our new design.

For Artemide, we translated this mathematical principle into light.

By working with elemental geometries, a square and a triangle, we created lamps that are complete objects on their own, yet capable of forming larger constellations when joined together."

Jakob Lange, BIG



ARTEMIDE  
APP

**Iperbole square**  
300 x 300 x h 175 mm  
cable max 1700 mm  
Total power: 9W  
3000K

● Aluminum

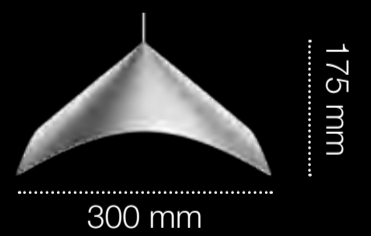
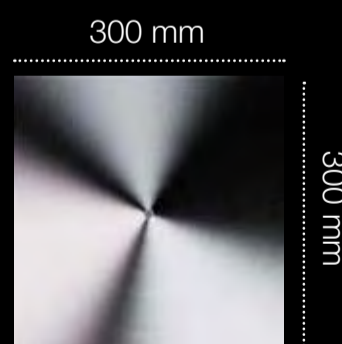
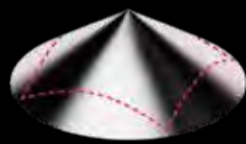

**Iperbole triangle**  
300 x 258 x h 102 mm  
cable max 1700 mm  
Total power: 9W  
3000K

● Aluminum

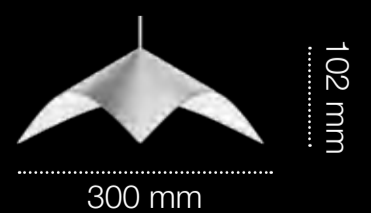
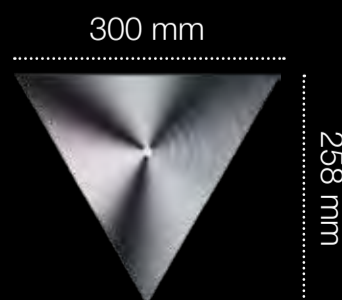
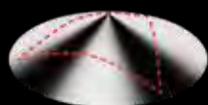



Iperbole is a system of minimal and lightweight suspension lamps that, whether used individually, repeated or arranged in clusters, bring comfortable light to any living or working space.

From the intersection of elementary geometries, a dynamic and elegant form emerges, simple and iconic, yet distinctive. The cone, the iconic profile of pendant lamps, intersects with a square plan.

Each side therefore describes a hyperbola, creating arches that, from different viewpoints, reveal more or less of the white interior of the lamp body—a luminous surface.

To enhance compositional freedom, a triangular-base solution accompanies the square geometry, enabling curvilinear as well as linear compositions. The sides of the square and triangular modules are equivalent, allowing them to combine into open or closed geometries.

This dimension is the unit that defines the angle of the two cones and their differentiated cut, thus distinguishing them also in depth.

## Modular Growth





300 mm

300 mm

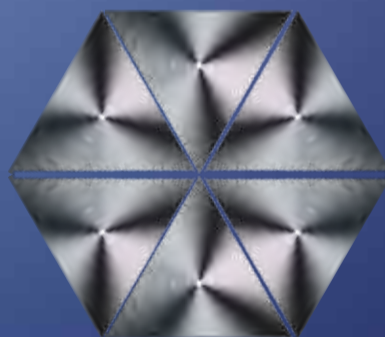
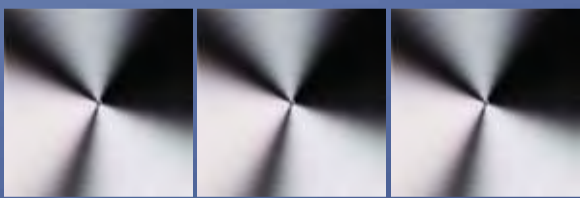

300 mm

258 mm

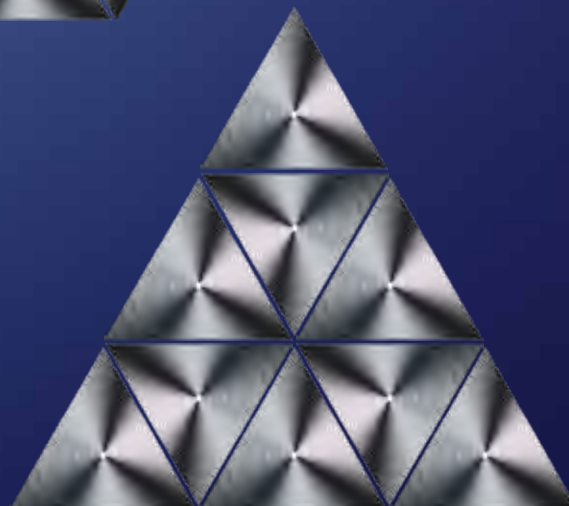



## Sustainable Material Reduction

The lamp body is made of a thin spun aluminum sheet, only 1,5 mm thick. Monomaterial, it minimizes the use of resources. Thanks to a specially designed lens, it is an energy-efficient system.

A central aspheric lens controls the emission, grazing the interior of the lamp body and distributing light in a homogeneous and comfortable way. The diffuser receives light but is not an active component in controlling emission, maximizing the lens control to achieve high efficiency and precision.

Glare is controlled: the geometry of the body extends downward to partially shield the view of the central lens, and luminance above 65° is regulated (<3000 cd/m<sup>2</sup>) in compliance with workplace standards.



High Optical Efficiency

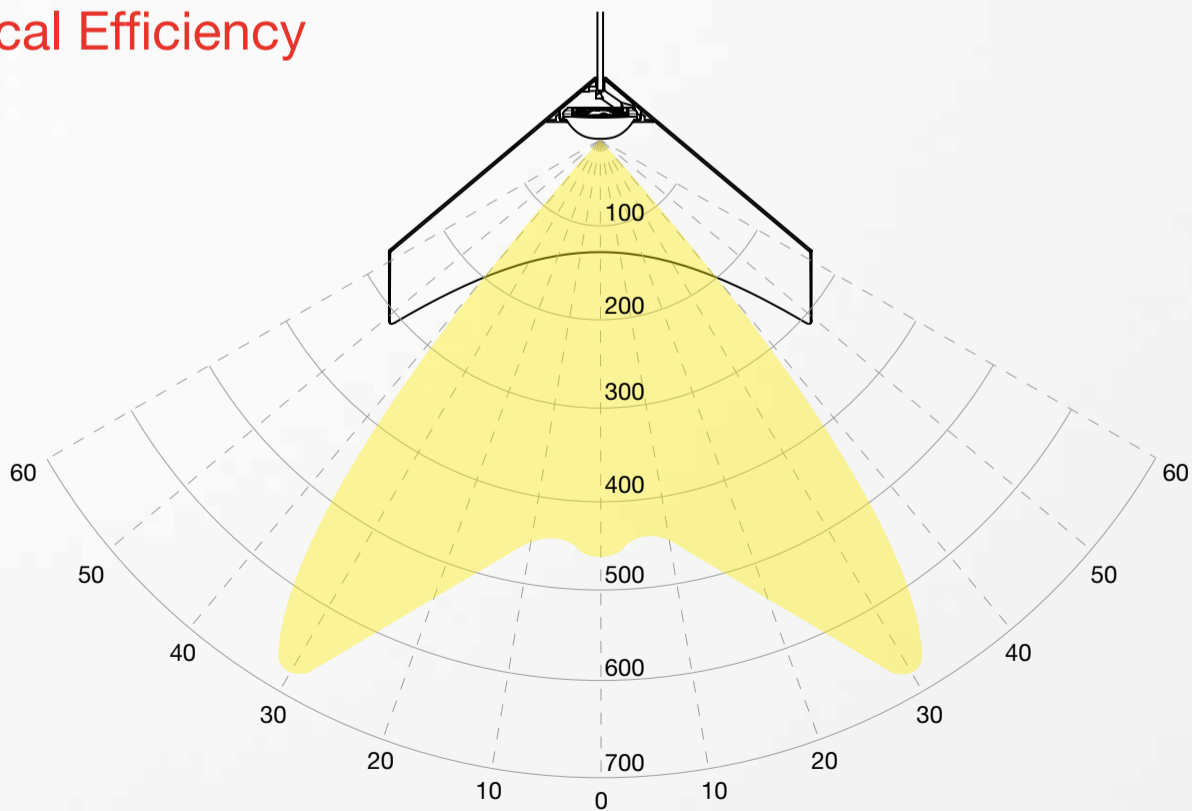



**Iperbole square chandelier**  
 300 x 300 x h 175 mm x 3  
 rose Ø200 mm  
 total cable max 10000 mm  
 Total power: 3 x 9W  
 3000K

**Iperbole triangle chandelier**  
 300 x 258 x h 102 mm x 3  
 rose Ø200 mm  
 total cable max 10000 mm  
 Total power: 3 x 9W  
 3000K

● Aluminum

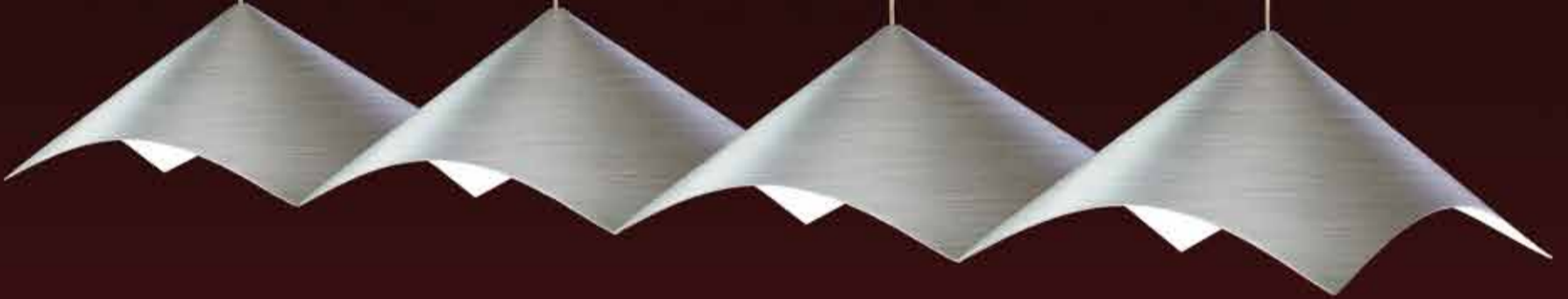

# Arctic BIG - Bjarke Ingels Group

PATENT OF  
INVENTION

"Arctic is inspired by the geometric formations of ice crystals. By combining triangles and pentagons, we created a sculptural crystal that elegantly captures and refracts light at its core."

Jakob Lange, BIG

Arctic is a collection of lamps that reflect and deconstruct reality, enhanced through their own light, natural light and the surrounding environment.

They are formed from geometric elements that break apart and reassemble in modular compositions, playing with reflections.

The final shape is an Archimedean solid without external faces, where the structure emerges from the projection of the pentagonal sides radiating from the centre. At its core there is a diffusing polyhedron.

This creates a multitude of mirrored surfaces, positioned side by side and facing each other, multiplying in perception and generating a dynamic figure that shifts with the viewpoint and its surroundings.

Arctic is a modular volume that takes shape through the relationship between its parts, guided by the principles of an intelligent and optimized construction.

ARTEMIDE  
APP

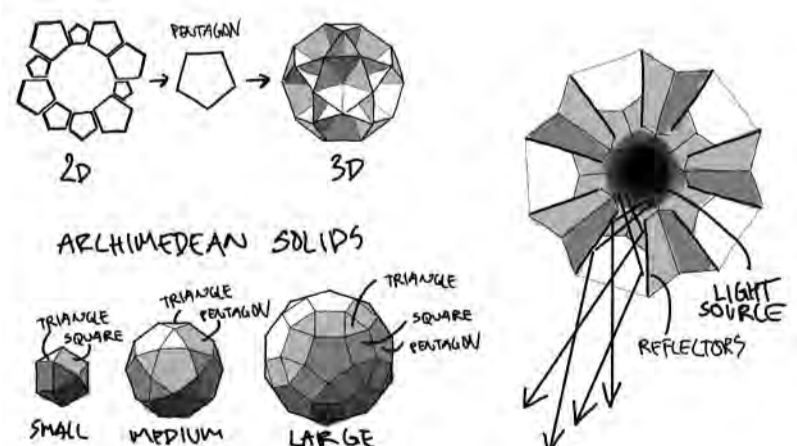

Sketches by Jakob Lange

Photo by Pierpaolo Ferrari





Arctic suspension  
Ø550 mm  
cable max 1500 mm  
Total power: 30W  
3000K

Central core

White

Reflectors

Transparent

Mirror



## Patented Optical Structure

The diffuser surfaces can be either transparent or mirrored, interacting differently with light. In both versions, they are horizontally etched with precision-calculated engravings to control and diffuse the light.

While these details define the product's aesthetic, they also serve an optical function, enhancing luminous efficiency through reflection and refraction.

While the mirrored version is always perceptible even when the light is off, the transparent one appears ethereal.



Arctic table/floor  
Ø550 mm  
Total power: 30W  
3000K  
Dimmer on cable

Central core

White

Reflectors

Transparent

Mirror



Arctic ceiling  
Ø550 mm  
ceiling rose 180 x 160 x h 73 mm  
Total power: 30W  
3000K

Central core

White

Reflectors

Transparent

Mirror

# Dusk

## BIG - Bjarke Ingels Group

"Since humans walked this earth, their internal clock has been governed by the rhythm of the sun. A colorful display of light, from the horizon to the zenith, warm and cold light blend to create a gradient of colours that has a profound effect on all living beings. With Dusk, we seek to create a true circadian light, not defined by a single colour of the sky, but by a dynamic gradient of colours that bring the sky's natural transition to life on the wall."

Jakob Lange, BIG





ARTEMIDE  
APP

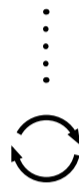
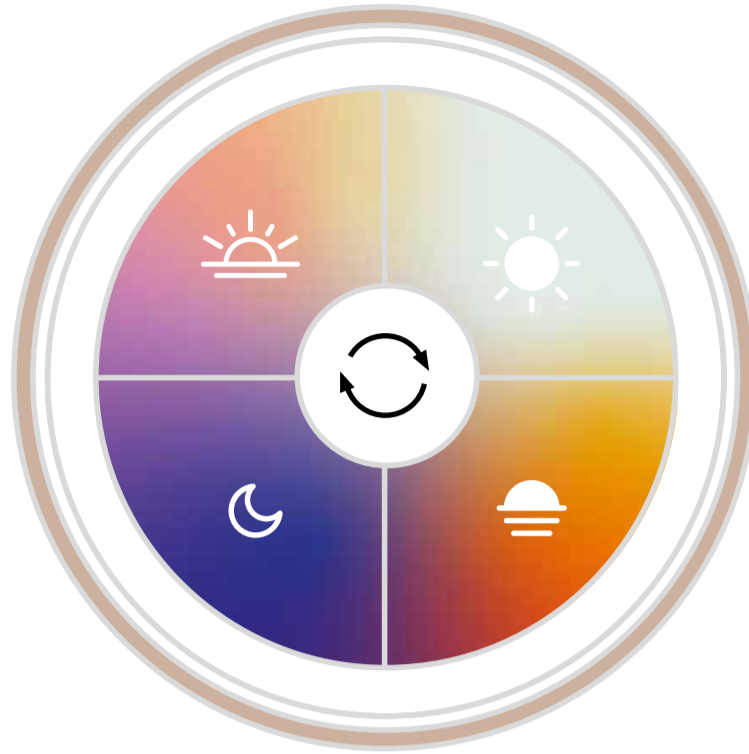

Dynamic natural scenario

Since the 1990s, Artemide has been exploring how changes in light, through colour temperatures and tonal variations, affect living beings and the natural world.

Dusk introduces a new concept, broadening the perception of natural light's variability beyond simple colour temperature.

It captures the full spectrum of hues associated with different times of the day and year. Its emission is not uniform but composed of two overlapping and balanced

light spectra, recreating the subtle tonal shifts of the sky as they transition vertically throughout the day.

Dusk does more than reflect colour temperature, it recreates the evolving chromatic panorama that accompanies each moment of the day, from dawn to dusk.

The perception of passing time can be managed wirelessly via the Artemide App thanks to a dedicated control with preset scenes where spectral calibration creates the luminous atmospheres of a natural setting.

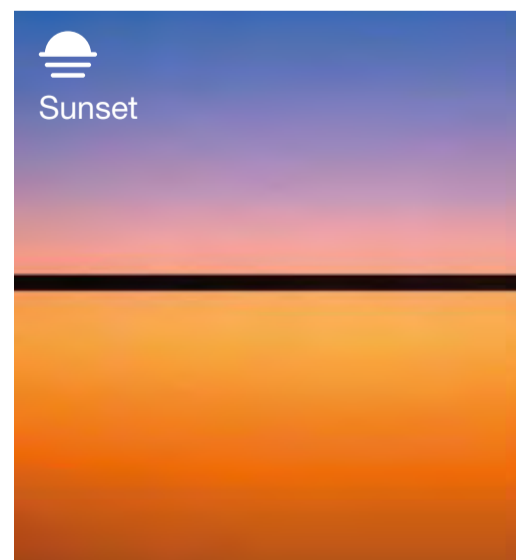
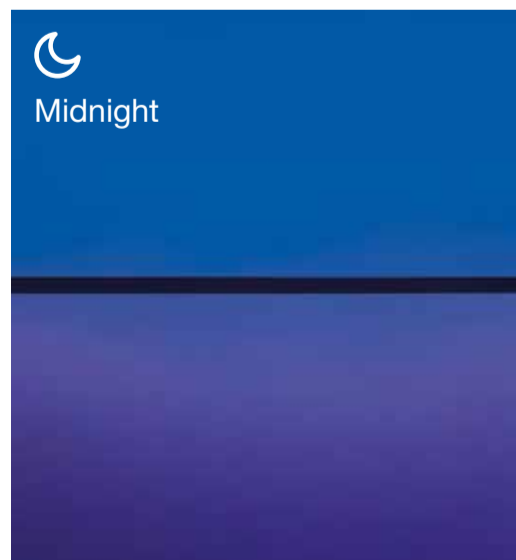
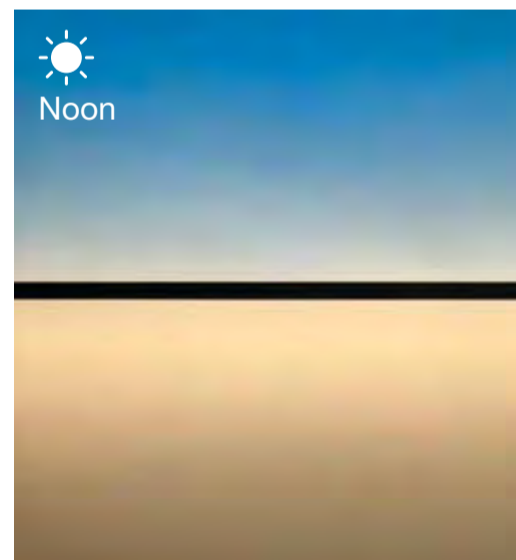
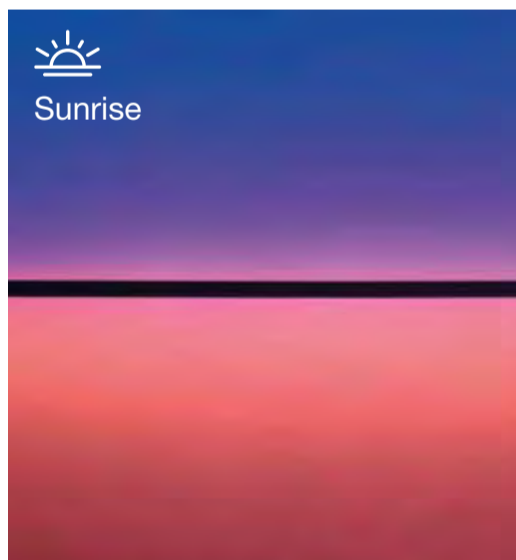

PATENT OF INVENTION

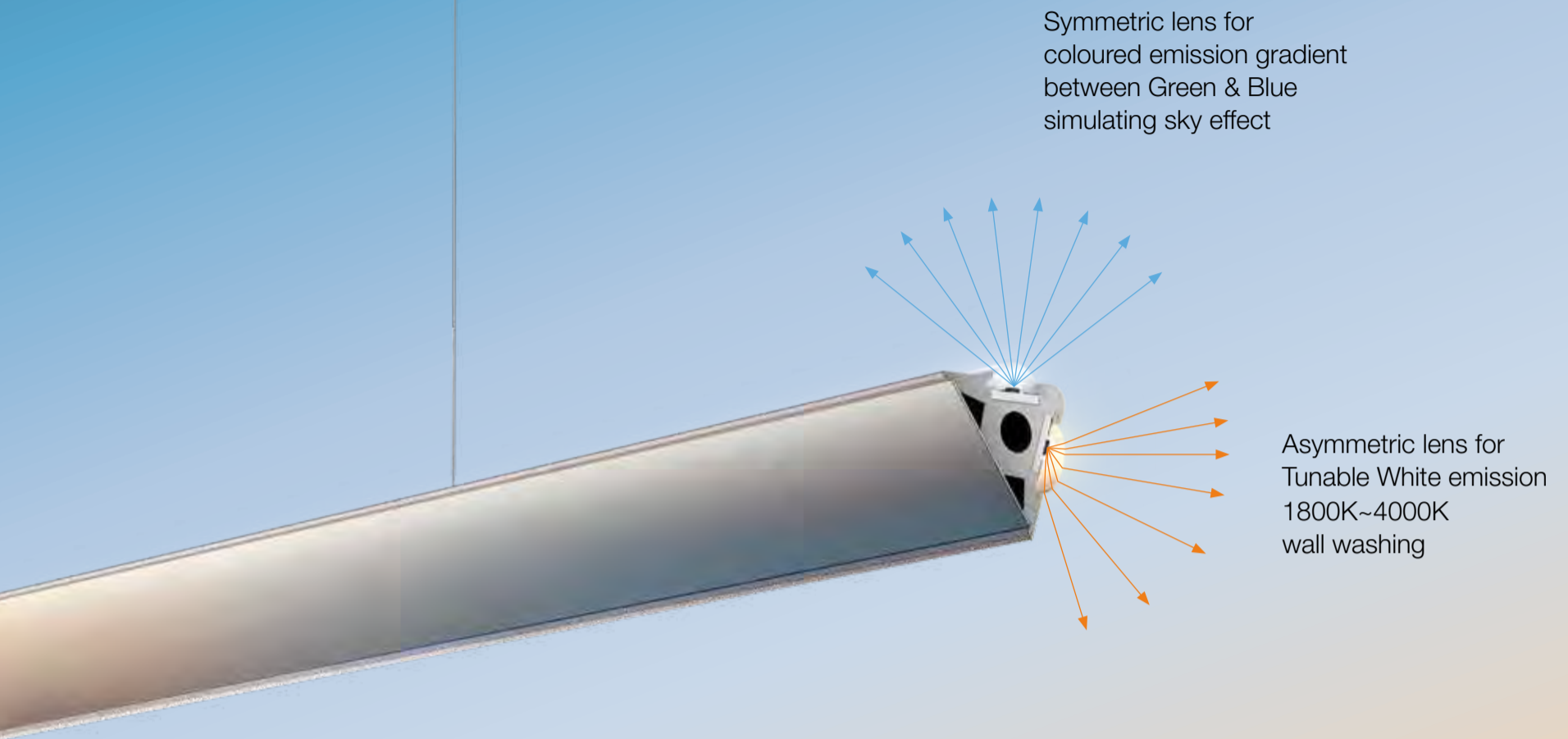

Symmetric lens for coloured emission gradient between Green & Blue simulating sky effect

Asymmetric lens for Tunable White emission 1800K~4000K wall washing

**Dusk module 1 m**  
25 x h 29 x 1000 mm  
Total power: max 30W

**Dusk module 2 m**  
25 x h 29 x 2000 mm  
Total power: max 60W

**Dusk module 3 m**  
25 x h 29 x 3000 mm  
Total power: max 90W

● Mirror satin

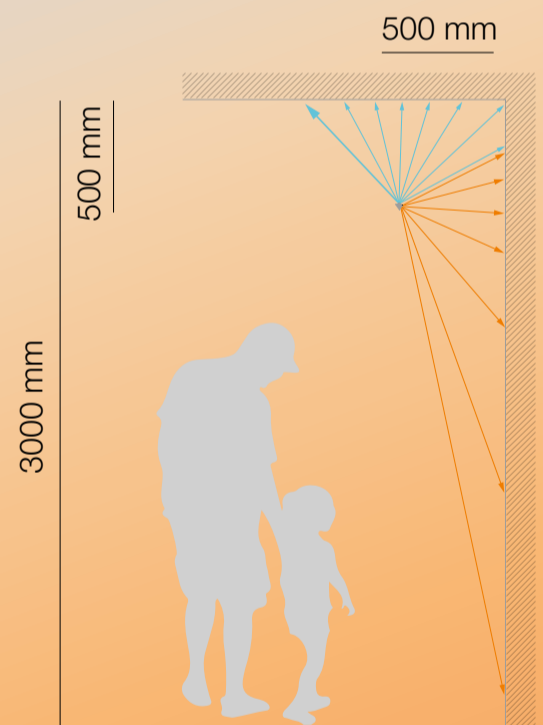

Designed as a wall washer, Dusk brings the fluid, ever-changing quality of natural light into closed spaces.

Rather than a single variable light source, Dusk combines two distinct emissions to reflect the colours of natural light, evoking the effects and poetry of the sky across daily and seasonal cycles. A lens controls a variable blue-toned light in the upper section, while an asymmetric lens washes the vertical surface with an emission ranging from 1800K to 4000K. The result is an immersive and dynamic experience.

In Dusk the interplay of intensities creates multiple lighting effects, where the two emissions blend into a soft white

glow before fading into warm tones or shifting from deeper colours to neutral ones, opening a new dimension of spatial perception.

Beyond enabling a poetic and perceptive approach to ambient lighting, Dusk is also highly functional, offering excellent colour rendering when the two emissions are properly balanced.

It can illuminate a space or serve as a backdrop that marks the passage of time, subtly shaping the environment in ways that profoundly influence psychological and physical well-being.



## The Right Wavelengths

In its continuous relation between humanity and the environment, light is a material for the construction of space, delimiting territoriality and influencing our state of mind.

Light feeds humans psychological and physiological well-being by introducing them to a broader dimension for a new perceptive experience.



Artemide  
Light Research

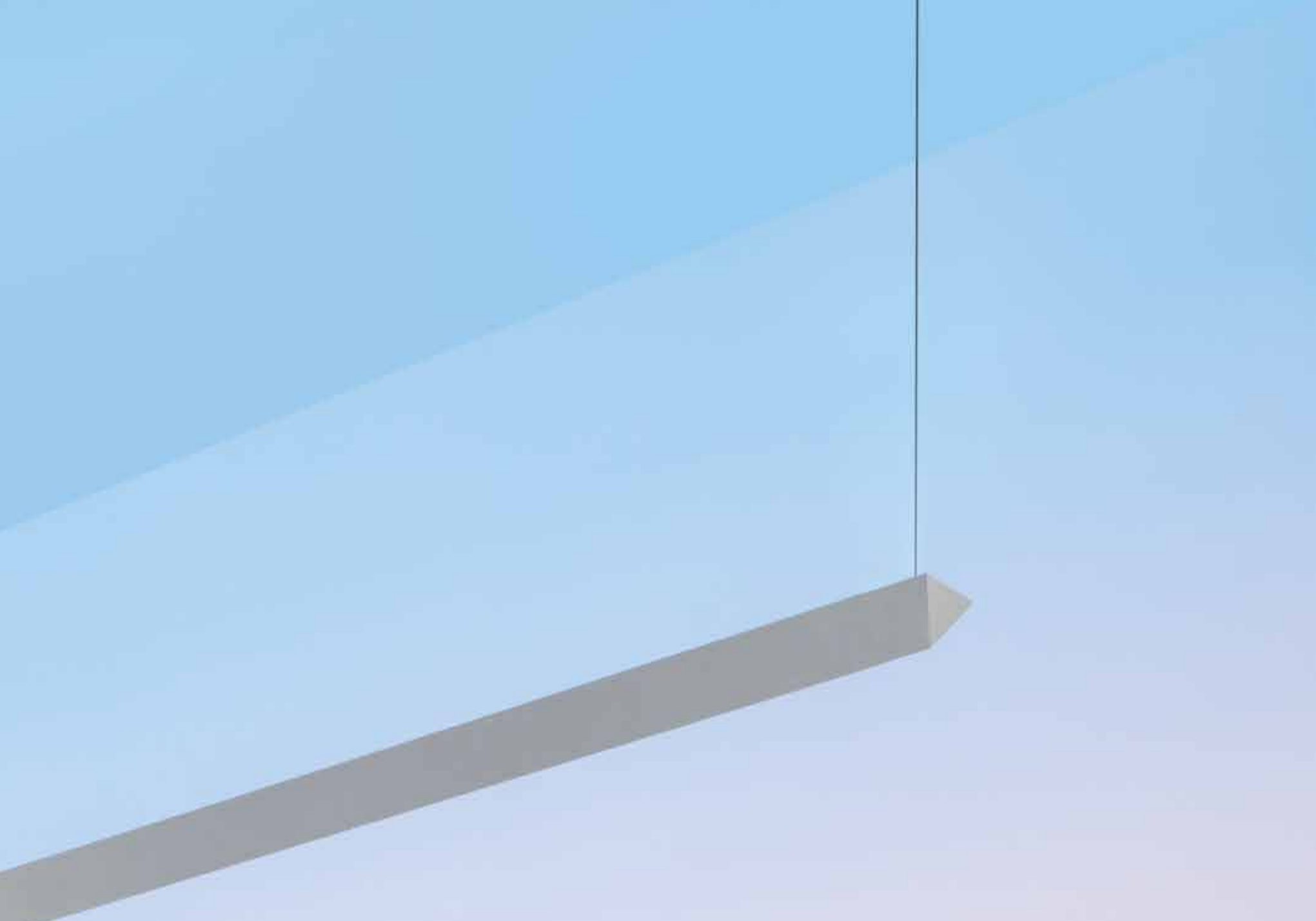

Tunable White 1800K~4000K  
 Wall washing emission  
 Green & Blue  
 Indirect emission

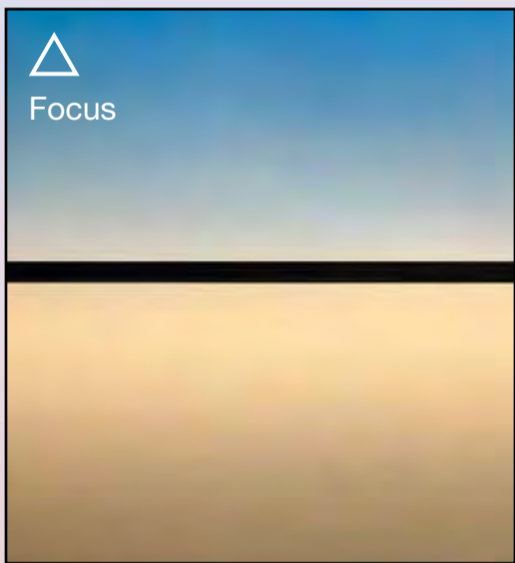

Total power  
 15W/m  
 T colour on the wall  
 4700K

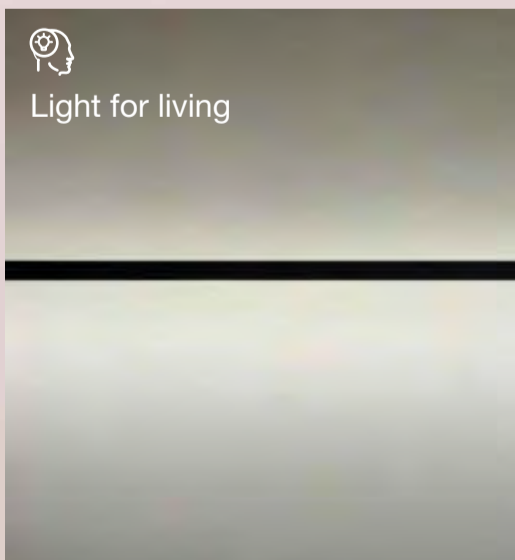

Total power  
 20W/m  
 T colour on the wall  
 3000K

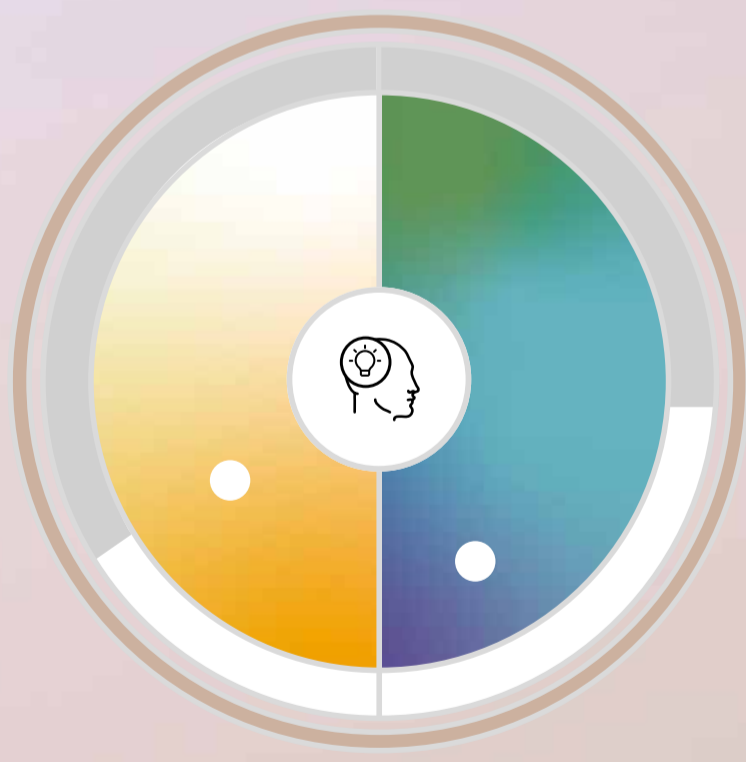

Light for living

By a specific Artemide App control interface, the two emissions can be managed independently to achieve functional light emissions that support circadian rhythm.

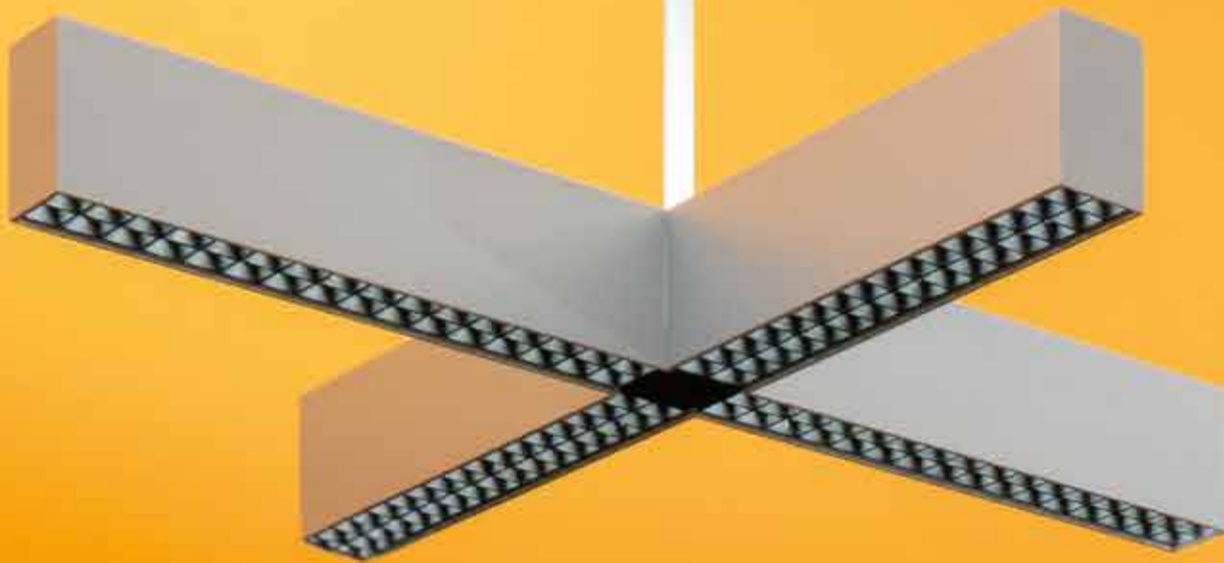

# Tetras SOM

Tetras is a lighting concept that helps to define space through luminous energy.

Its cross-like structure becomes an architectural symbol, the junction of a grid that belongs to the space and can exist alone or as part of a system.

Available in three sizes, it is a pure, straightforward element. It expresses a precise spatial rhythm while remaining open to interpretation. Like an architectural component, it adapts naturally to any layout.

Tetras can be used to create regular grids of identical units or to combine different sizes, generating varied balances and rhythms. It becomes a graphic and expressive tool for shaping space, building visual compositions and spatial narratives.

Its position places no limits on how the space is used. It introduces a clear spatial framework within correct lighting parameters, making it a versatile option for many different contexts.



## Lighting Bricks

Starting from even the most constrained rules for workspaces, Tetras provides a comfortable light. Its very high quality and efficiency make it well suited to bringing good lighting to museums, hospitality settings and public spaces.

Its rigid geometry becomes dynamic within carefully measured parameters. It suggests a grid that can be broken or restructured to create different relationships between space, light and function, even across varying ceiling heights.

What begins as measured and orderly can become expressive and scenographic, with combinations of colour and size that follow a structured pattern or a completely free arrangement.

Tetras fits seamlessly into architectural projects and is as universal as a brick. Conceived to embody rigour and technical precision, it breaks those boundaries.

It becomes a symbol, a design language in its own right, capable of engaging directly with the proportions and rhythm of architecture.

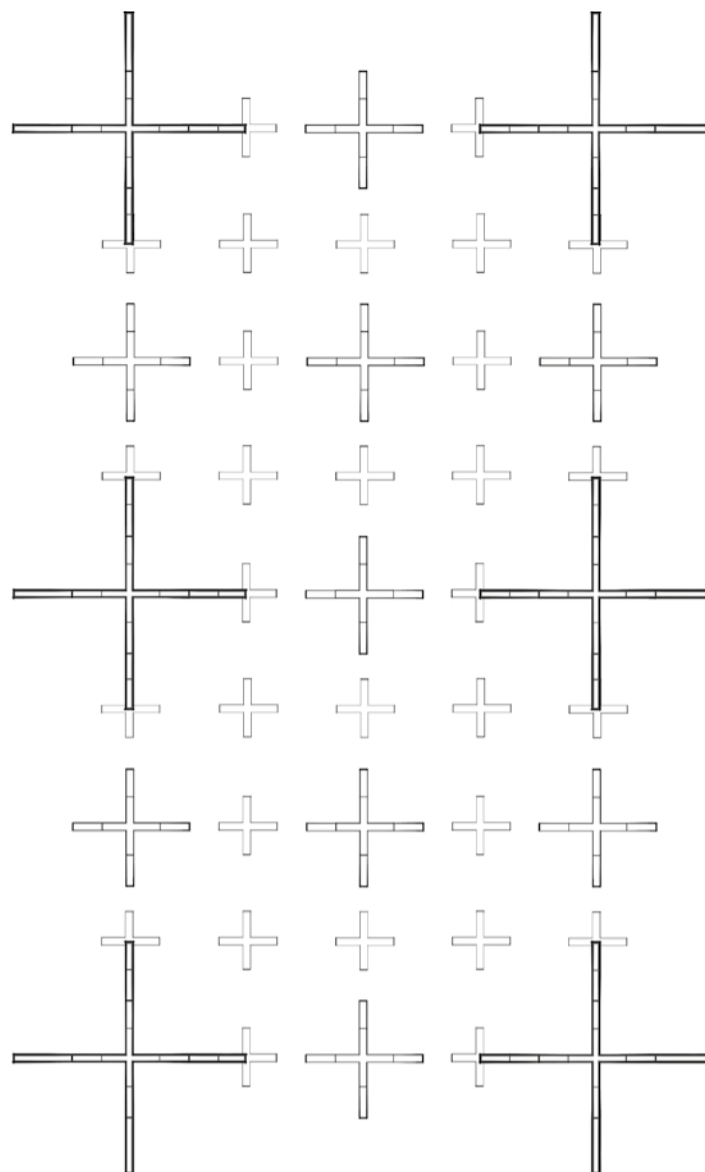

"Tetras conceives of light as an architectural building block, a single element that is deployed in series to create volumes of illumination. As a module for illumination, it allows designers to use light as an instrument of architecture, a field of points whose size and spacing can be customized and tailored to a variety of environments and adapted to future needs."

SOM - Skidmore, Owings & Merrill





## DIFFUSED EMISSION



**Tetras small**  
 345 x 345 x 75 mm  
 tige h max 1000 mm  
 Total power: direct 9,5W  
 indirect 9,5W  
 3000K / 3500K

**Tetras medium**  
 495 x 495 x 75 mm  
 tige h max 1000 mm  
 Total power: direct 14W  
 indirect 14W  
 3000K / 3500K

**Tetras large**  
 640 x 640 x 75 mm  
 tige h max 1000 mm  
 Total power: direct 19W  
 indirect 19W  
 3000K / 3500K

- Black
- White
- Silver
- Red

PATENT OF  
INVENTION

High efficiency  
83%

Extreme efficacy  
up to 148 lm/W

Extreme glare control  
UGR<16

CRI 90

High uniformity  
no multi-shadows

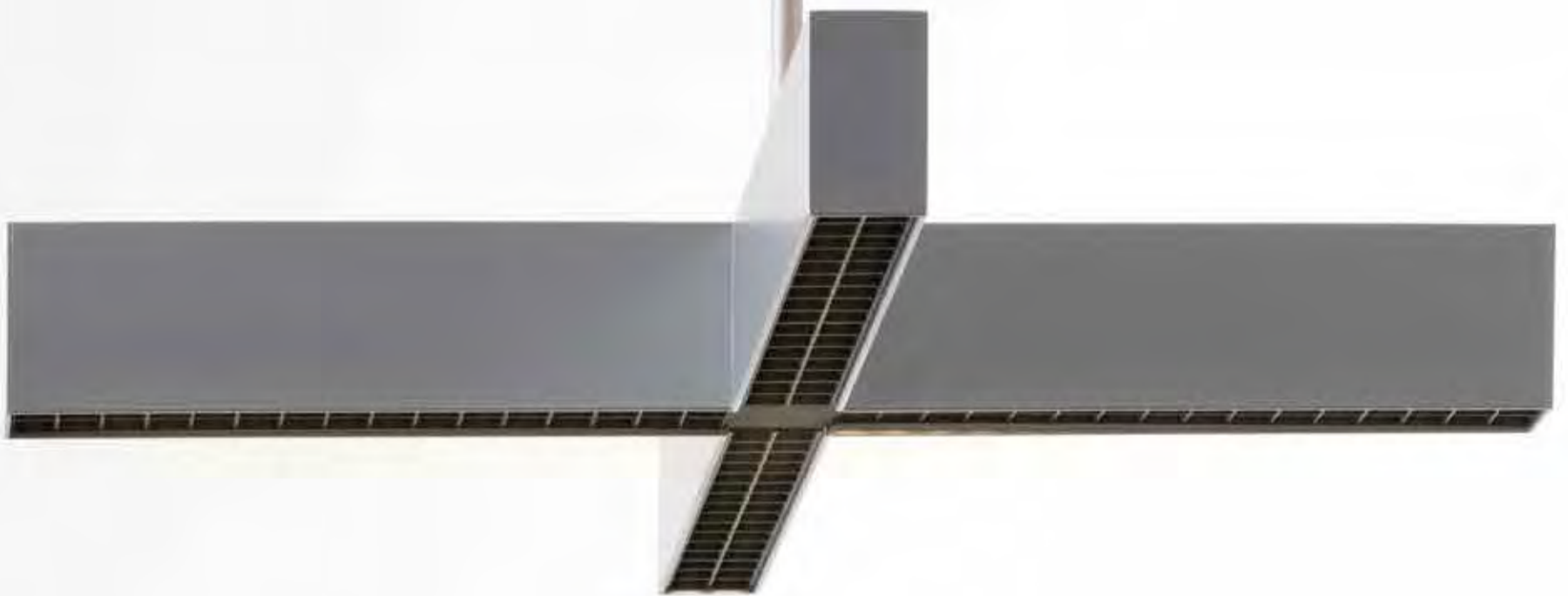

## MICROREFRACTIVE OPTICS



Tetras large refractive  
640 x 640 x 75 mm  
tipe h max 1000 mm  
Total power: direct 19W  
indirect 19W  
3000K / 3500K

- Black
- White
- Silver
- Red

# Boltons Herzog & de Meuron

"The Boltons lamp, consisting of a light source encased within a hand-blown artisanal glass body that directs the light to an adjustable reflector, encourages engagement and exploration of fundamental lighting principles. Boltons' idea materializes core aspects of illumination."

Herzog & de Meuron

It is a lamp that combines a patented optical system with the beauty of hand-crafted glass. A transparent body supports an adjustable metal disc.

The body is shaped in a single, skilled movement using a traditional technique. The diffuser surface is not perfectly flat, is moved by a vibration that expresses the craftsmanship and the uniqueness of the glass. Its complete transparency highlights the thickness of the material, shaped by the master glassblower's breath: thicker at the top, finer at the sides where it tapers.

The lens is perceived as a seamless continuation of the elegant glass form. This poetic, evocative shape also defines the ability to direct and modulate light across a surface.

## **Boltons**

diffuser Ø235 x h 375 mm

reflector Ø450 mm

Total power: 12W

2700K

Dimmer on cable

## **Reflector**

● Silver

## **Diffuser**

● Transparent

Photo by Pierpaolo Ferrari



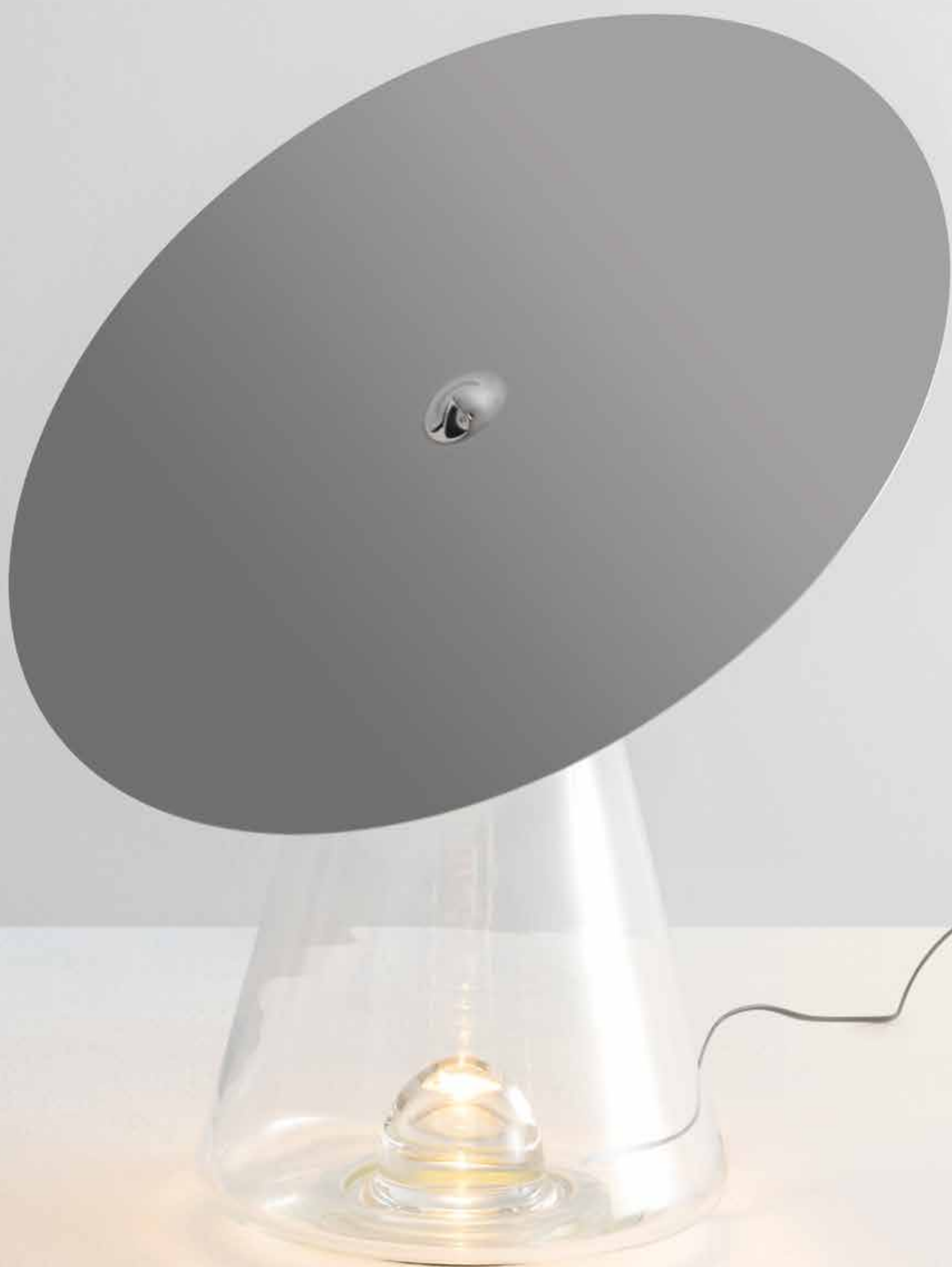





## Patented Optical Design

A lens at the base directs the entire light output upwards with precise control, allowing the disc to reflect it according to its angle. As the beam passes through the glass, it brings it to life with reflections, without compromising the efficiency of the optical system.

The geometry of the glass allows for wide freedom of movement of the upper reflector, held in place by a magnetic sphere.

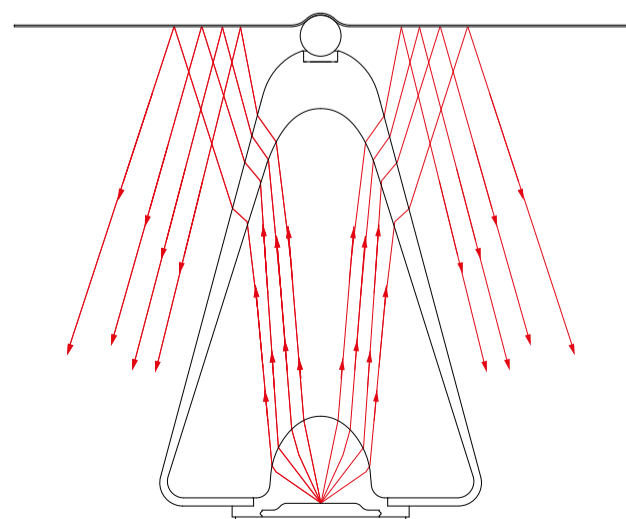
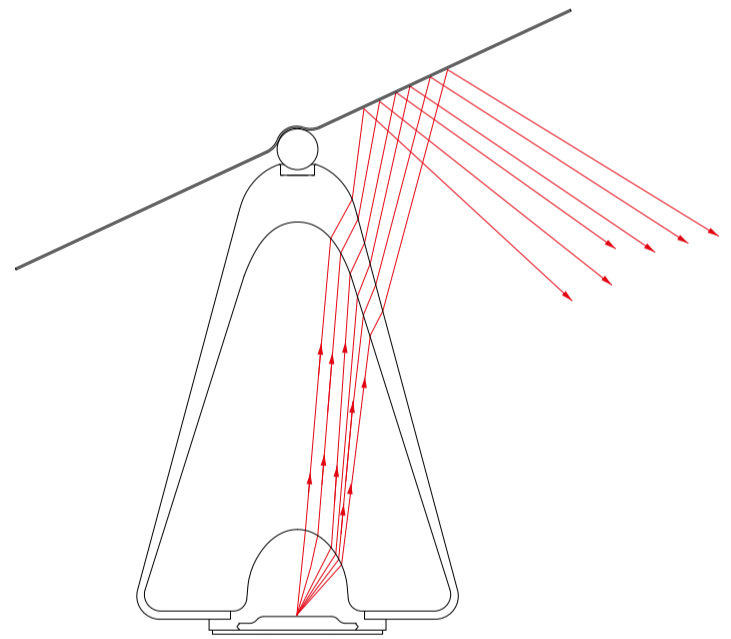



# Ulrich und Diotima Carlotta de Bevilacqua



Ulrich und Diotima is a collection of essential, pure wall lights paired with a glass element, elegant and rich, in its interaction with light.

Two bases are defined by minimal geometries, shaped through an extreme process of synthesis balanced with technical requirements. The optoelectronic solution, featuring mains-voltage LED, optimizes not only the quality of light but also the components, reducing overall dimensions to the minimum necessary.

The first model consists of a small square base with rounded corners, projecting just enough to distribute light correctly within the space, while concealing the wall fixing inside a recessed mounting system.

The second typology introduces a profile that follows the wall, defining an L-shaped section that allows for surface mounting.

Like Ulrich, the (apparently) man without qualities in Musil's novel, intellectually rich yet devoid of outward passion, these essential elements are paired with a luminous and refined blown-glass sphere, reminiscent of Diotima, the more frivolous cousin, capable of captivating everyone through her charm and intelligence.



**Ulrich und Diotima**  
140 x 120 x h 15 mm  
glass diffuser Ø110 mm  
Total power: 15W  
2700K / 3000K

**Ulrich L und Diotima**  
148 x 120 x h 135 mm  
glass diffuser Ø110 mm  
Total power: 15W  
2700K / 3000K

- Mirror
- White glossy
- Black glossy
- Brushed copper

**Diffuser Diotima**

- Transparent

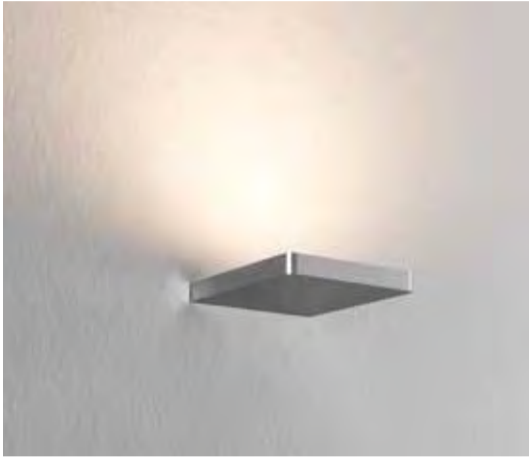

**Ulrich**  
140 x 120 x h 15 mm  
Total power: 15W  
2700K / 3000K

**Ulrich L**  
148 x 120 x h 135 mm  
Total power: 15W  
2700K / 3000K



- Mirror
- White glossy
- Black glossy
- Brushed copper



The two bases support a transparent Craquelé glass sphere, shaped by thermal shock into a uniquely textured surface. While still hot, the blown glass sphere is immersed in cold water: the surface fractures, creating delicate cracks that leave the interior intact while tracing a subtle decorative pattern.

The result is an irregular glass surface, interwoven with fine cracks that come alive with light, reflecting the texture into the surrounding space in a delicate interplay of light and shadow.



# Agathe Carlotta de Bevilacqua

Agathe is an essential and rigorous wall light, characterized by a compact parallelepiped volume. The light emission is bidirectional: the light opens upwards and downwards from two recessed diffusers integrated into the body of the fixture.

Its clean, angular geometries combine with a wide range of finishes — from more minimal to warmer tones — allowing it to adapt to any application context.

Clean in its lines and free of superfluous additions, this wall light combines formal minimalism with quality of light, becoming a discreet yet elegant and functional element.

Agathe, an enigmatic and intense figure, is the sister of Ulrich, the alter ego of the man without qualities in Musil's novel. It completes the collection of new wall lights that explore different expressive possibilities of the design, always with careful attention to lighting performance and reduced dimensions.

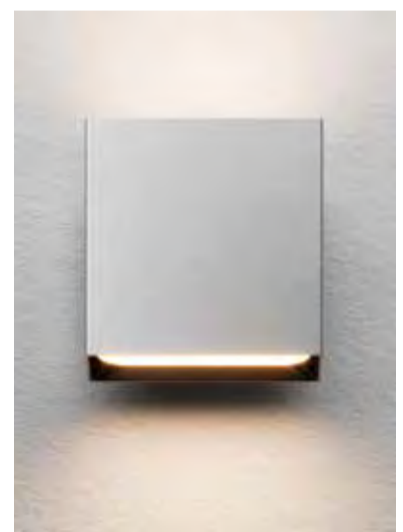

Agathe  
150 x 75 x h 150 mm  
Total power: 20W  
2700K / 3000K

- Black
- White
- Brushed silver
- Brushed copper
- Brushed bronze



# Criosfera 175 Giulia Foscarì UNA/UNLESS



## PATENT OF INVENTION

"Criosfera, the cryosphere, encompasses all components of the Earth System that are frozen. 90% of such ice is in Antarctica. That same ice is the largest repository of data on our climate history. It is a time capsule that enables scientists to trace the climatic history of our planet, extracting from captive air bubbles trends of CO<sup>2</sup>, greenhouse gasses and temperature from past glacial and interglacial eras.

The quintessential marker of climate change is thus the Ice Core, a cylinder of stratified ice extracted from the depths of our planet's ice sheets. The ice core thus becomes the element that creates awareness and calls to action."

Giulia Foscarì

Criosfera is a synthesis of optical, material and scientific knowledge which translates into a manifesto of values between the present and the future.

The external blown glass cylinder is the structure inside which the optoelectronic engine disappears without visible shadows. Its uniqueness is linked to the craftsmanship. Engravings are impressed into the hot glass before blowing and makes its thickness wavy and irregular.

It contains the measured perfection of optical extrusion whose section diffuses the light without making the sources inside visible. This core can develop in different lengths. The collection now includes three different sizes of light modules.

The first, shorter, fits into the space with three different essential structures, which refer to the scientific instruments used to extract and analyze ice cores. Then, a one meter glass is suspended, horizontal or vertical. A new longer light module now composes a horizontal suspension and a minimal floor version.



## A Manifesto of Values and Know-how

Structural hand-made glass

Traditional technique

Technological internal core

Industrial optical intelligence

High efficiency

Criosfera 175 suspension  
Ø100 x 1750 mm  
cable max 1700 mm  
Total power: 58W  
2700K / 3000K

○ Transparent

ARTEMIDE  
APP

"Criosfera is not just a light. It is a resolution, a manifesto of our times. One that is imbued with optimism that we will, individually and collectively, defend intergenerational justice. Lights on. It's action time."

Giulia Foscari



**Criosfera 175 floor**  
Ø100 x h 1750 mm  
Base Ø300 x h 10 mm  
Total power: 58W  
2700K / 3000K  
Dimmer on cable

**Base**

Mirror

**Diffuser**

Transparent



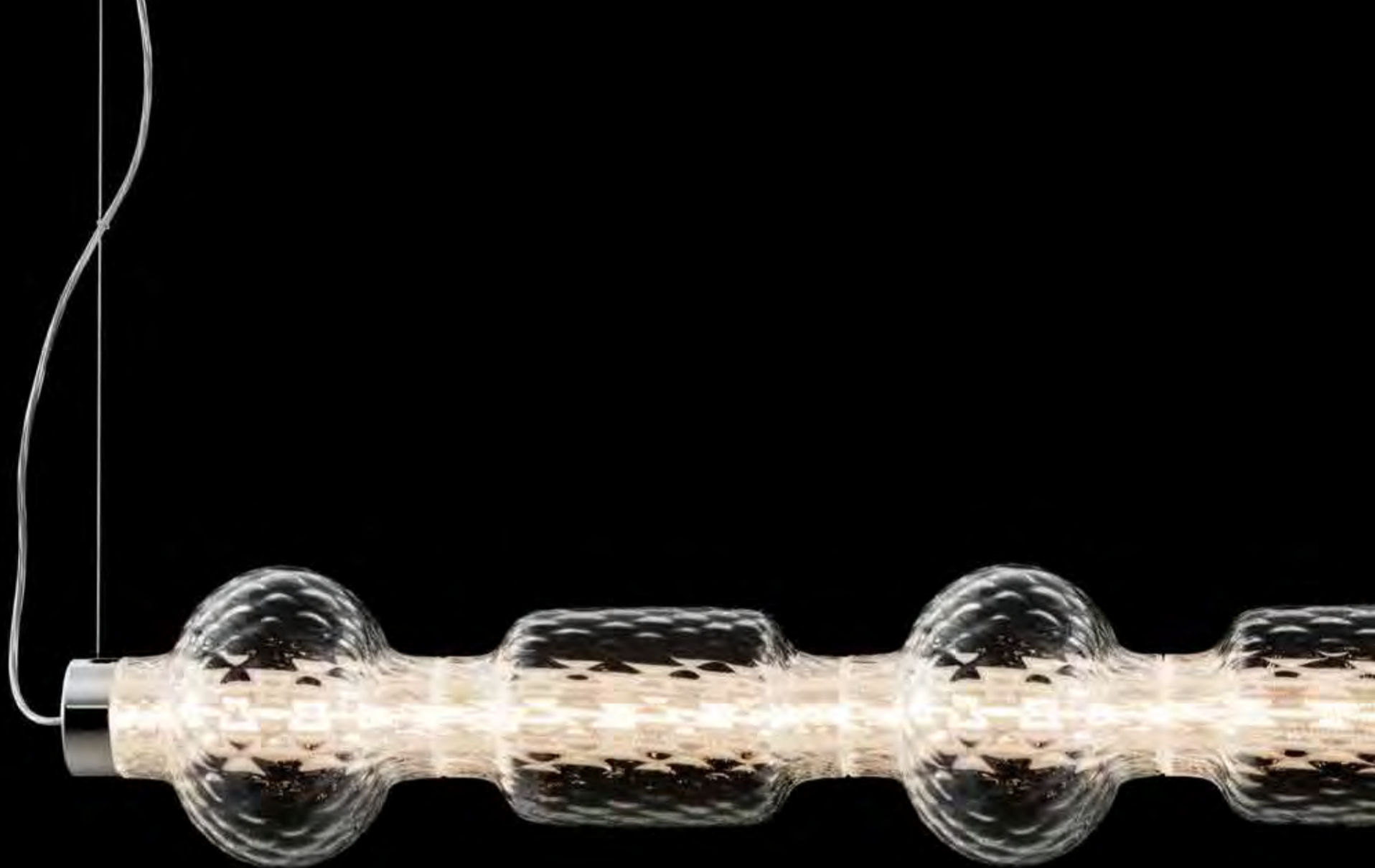

# Alambicco 165

## Neil Poulton

Alambicco is a modular light fixture that captures the beauty of blown glass, playing with transparencies and textures to control and diffuse light.

The extruded aluminum structure in the centre supports LED circuits on the four opposing faces and is the technological core around which the various layers develop.

The first layer consists of a knurled glass cylinder, designed to refract the view of the technological components without completely hiding them, ensuring the LEDs are non-glaring.

Set on this there are diffusers with rounded geometries, always transparent but enriched by a craftsmanship that draws inspiration from the ancient Balloton technique.

The hand-blown technique generates a three-dimensional texture that comes alive with the interplay of light.

**Alambicco 165**  
diffuser Ø190 x 1640 mm  
cable max 1500 mm  
rose Ø290 mm  
Total power: 53W  
2700K / 3000K

### Structure

Mirror

### Diffuser

Transparent

ARTEMIDE  
APP

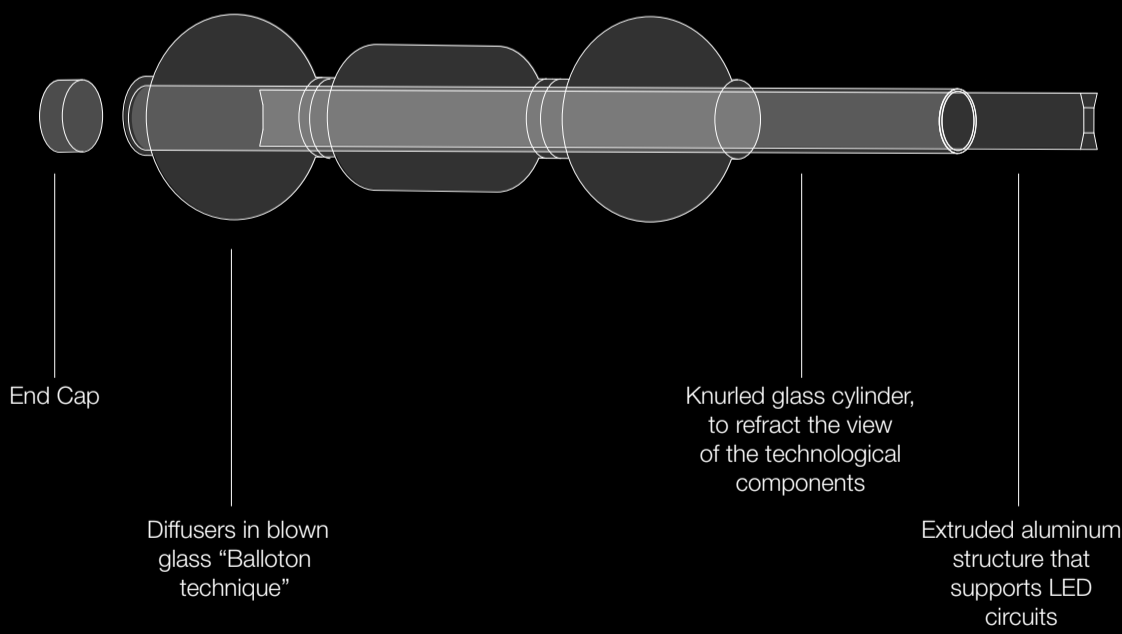
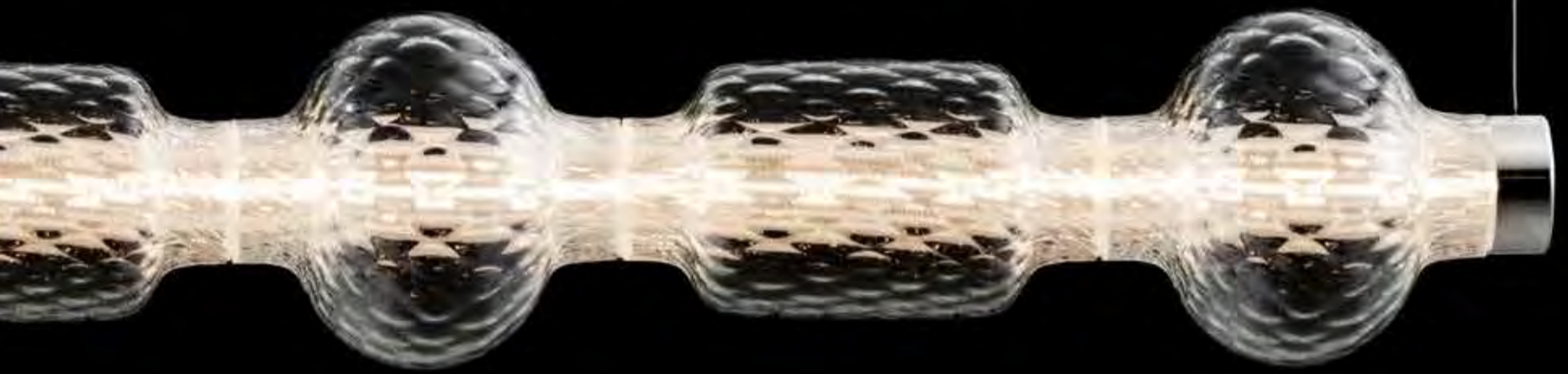

**Hand-made glass**  
Balloton traditional technique

**Optical intelligence**  
Light control through the textured glass

**Modular structure**  
2 glass geometries

ALAMBICCO AND ALAMBICCO XL

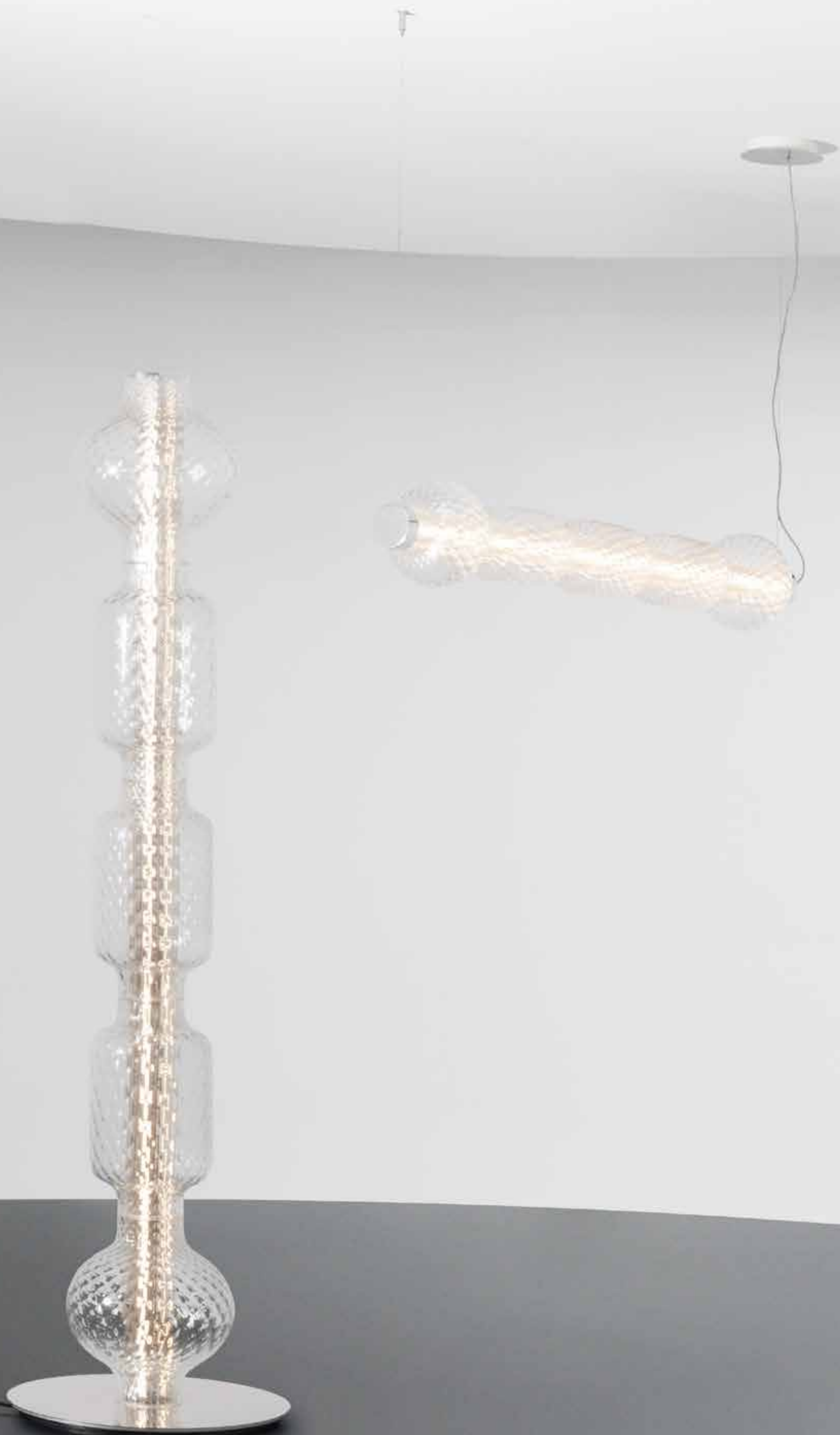



Each piece is unique, animated by reflections due to the varying thicknesses of the glass and the texture that follows the geometries of the diffusers, opening and closing the mesh of the design.

The glass diffusers have two shapes and two dimensions. Alambicco combines the craftsmanship and uniqueness of glass with the modularity of the composition, allowing the creation of a family of solutions and opening the perspective to develop proposals tailored to specific projects.

**Two blown glass dimensions**  
Alambicco Ø190 mm  
Alambicco XL Ø270 mm

**Horizontal or vertical structure**

# Somnium

# Carlotta de Bevilacqua

PATENT OF  
INVENTION



"Light is a pure element that lives by its transparency, like air and water, it has no pretence of presence, it has a scientific reason."

Carlotta de Bevilacqua

Somnium is a system born from the fusion of optical, structural and production principles, brought to life through transparency. At its core there is an optical cell, engineered for maximum efficiency and optimal perception. Much like a cell, it reproduces and collaborates within the system, creating a seamless flow.

The optical calculation daringly embraces the material's transparency, achieving a flawless blend of all the elements typically found in a lighting control system.

The lens, the primary tool for gathering and directing light, combines with the anti-glare, typically used to shield vision for increased comfort. These two elements, traditionally contrasting in material, converge into a single component.

The louvre is no longer an accessory but an integral part of the optics itself. The result is perfectly within all parameters of comfort and correct perception, it even achieves a UGR<16.

The resulting emission is a soft, comfortable light that opens up into the space with a controlled beam of 2x35°. It is combined with a diffused indirect emission.

The optical element, crafted from a singular material, embodies sustainable industrial intelligence in its design. It reduces material diversity, minimises weight and simplifies production steps.

Through linear, curved modules and now a 90° angle, it is possible to create continuous lines up to 15m long.

**Open platform**  
Engineered for a replicable perfect coincidence  
among optics, mechanics and electronics

**Spatial dialogue**  
Systemic composition





High efficiency  
93%

High efficacy  
160 lm/W

Direct emission & Extreme glare control  
UGR<16

## Optical Control through Transparency

Refractive lens  
and TIR (total internal reflection) antiglare  
Collect 100% of the LED luminous flux  
and reflect secondary rays  
maximizing the flux output

A perfect sustainable synthesis  
of the optical control elements  
Antiglare & Lens, usually made by contrasted  
materials, come together in a single  
miniaturized transparent component

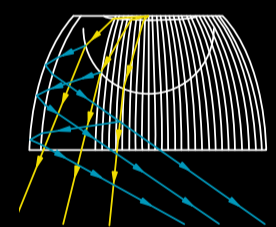

Materic convergence  
between lens and antiglare  
Optical PMMA

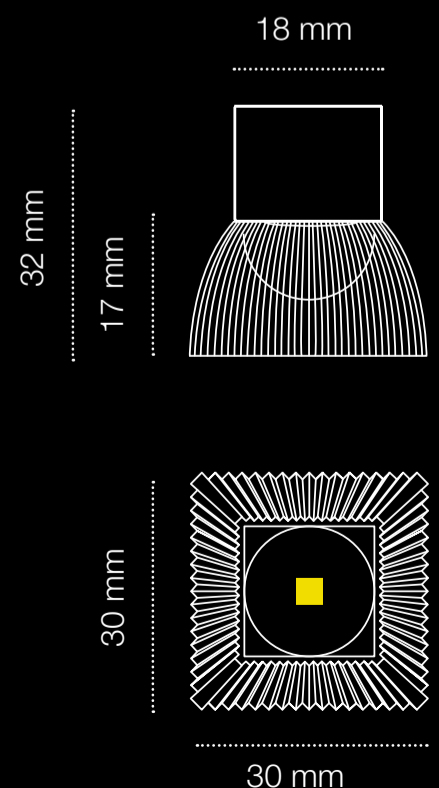



Linear module 420  
5,4W - 829 lm



Linear module 840  
10,5W - 1659 lm



Linear module 1260  
16W - 2488 lm



Linear module 2100  
24W - 3710 lm



Angular module 90°  
5,4W - 829 lm

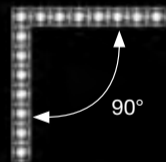

225 mm

ARTEMIDE  
APP

Round module 90°  
5,4W - 829 lm

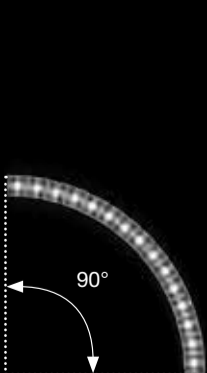

R282,5 mm

Round module 60°  
5,4W - 829 lm

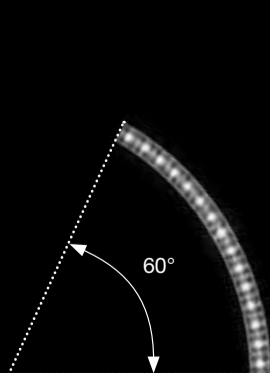

R416 mm

Round module 120°  
10,5W - 1659 lm

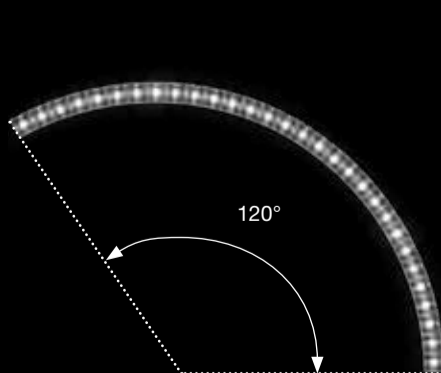

R416 mm

Round module 45°  
5,4W - 829 lm

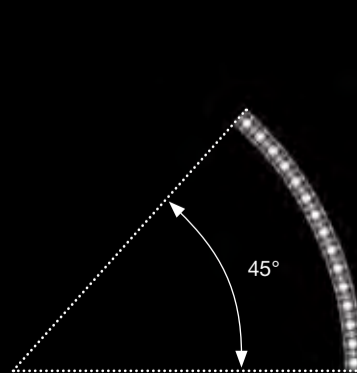

R550 mm

Round module 90°  
10,5W - 1659 lm

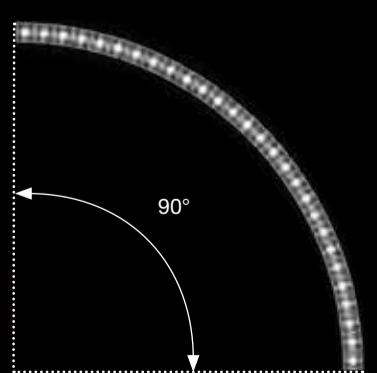

R550 mm

Photo by Pierpaolo Ferrari



# Vea

## Foster+Partners

### Industrial Design

"Vea explored the themes of poise and balance. Here, the concept has been translated into a light fixture capable of providing a wide pool of light from above that can be adjusted and lowered to create a more intimate lighting effect."

Mike Holland, Foster+Partners Industrial Design

Vea is a floor lamp designed for both indoor and outdoor use. It comes in two heights, accommodating both interior settings and larger outdoor areas.

Vea embodies a light, minimalist and elegant design that plays with the balance of its base. Its structure allows the light to be raised or lowered to various heights, illuminating areas of different sizes.

It combines a long, slender stem with a V-shaped base, the centrepiece of the design.

The V-shaped base cradles the stem, allowing it to incline from a vertical position up to the desired degrees. This is achieved through a clever play of balance and support, seemingly simple in appearance and use, yet complex in the design definition to achieve the perfect equilibrium.

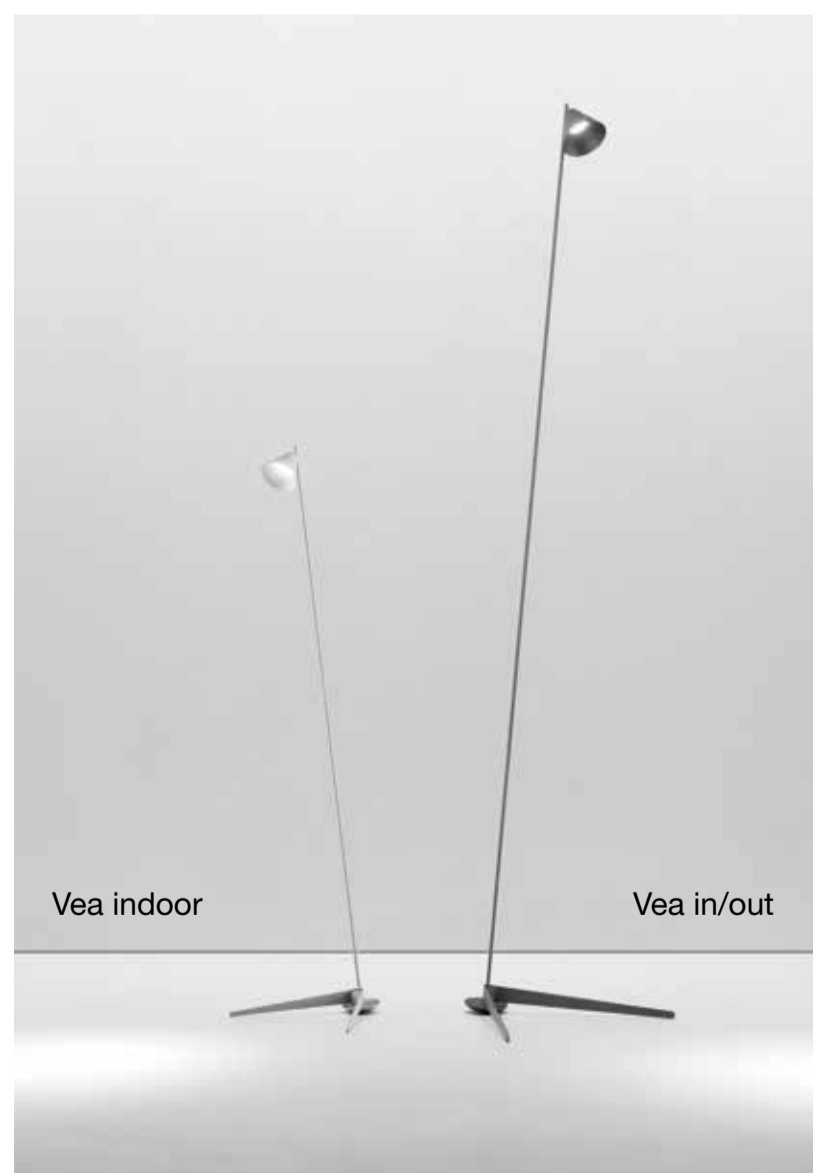

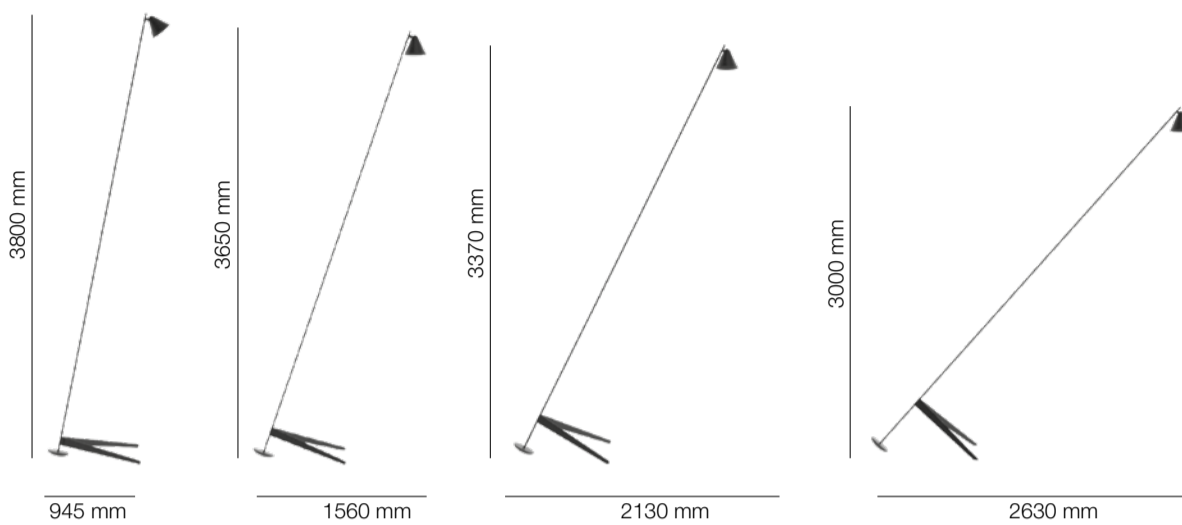

Vea floor in/out  
 V base 1120 x 795 mm  
 h 3850 mm  
 Total power: 10W  
 3000K  
 IP65

● Black grey



### Reverse Fresnel Lens

**Patented optical design**  
 Optical micro-grooves oriented toward the light source and perfectly flat output surface

Geometry designed to protect the optical element from atmospheric agents

**High performances**  
 Perfect light beam control  
 No glaring  
 High efficiency  
 High uniformity



# VEA FLOOR INDOOR

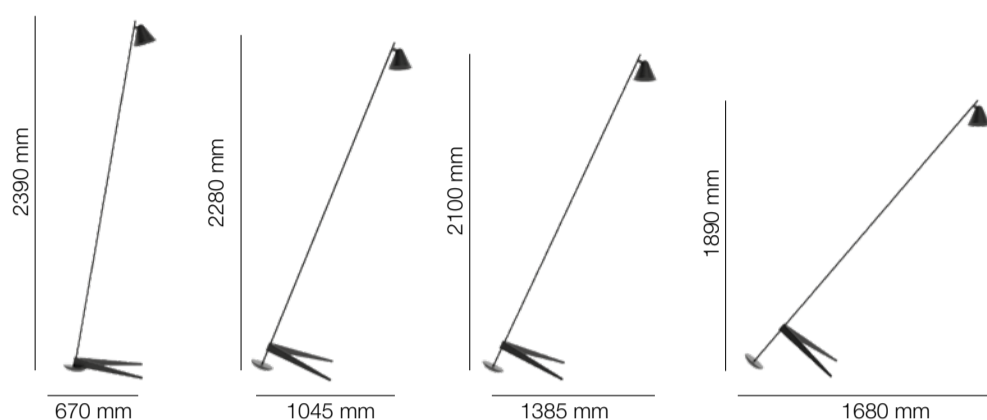

**Vea floor indoor**  
V base 730 x 585 mm  
h 2405 mm  
Total power: 11W  
2700K / 3000K  
IP20

- Black grey
- White
- Platinum grey



## Free light movement

Unrestricted stem lean  
Stem and head rotation 360°  
Head tilting 130°





## VEA SUSPENSION



**Vea suspension 19**  
Ø195 x 120 mm  
cable max 1700 mm  
Total power: 7,5W  
Dim to warm  
IP20

**Vea suspension 55**  
Ø550 x 360 mm  
cable max 1700 mm  
Total power: 18,5W  
Dim to warm  
IP20

**Vea suspension 89**  
Ø890 x 595 mm  
cable max 1700 mm  
Total power: 44W  
Dim to warm  
IP20

- Anthracite
- White
- Platinum grey

### Internal surface

- China clay yellow

**Dim to warm**  
**1800K~3000K**

**ARTEMIDE**  
**APP**



Vea suspension features a simple conical form that enhances its perceptual richness.

With a dim to warm technology it creates an even warmer and more inviting atmosphere as the intensity is adjusted.

The recessed diffusing surface is designed to ensure comfortable light emission.

Colour choices play a key role in defining Vea suspension: the exterior shade is paired with a warm-toned interior, softening the light output and ensuring Vea retains its presence even when switched off.

A versatile solution bridging public and private spaces, with three different dimensions to be used alone or combined in a landscape of elegant elements.





## VEA BOLLARD

From Veia's iconic head emerges a versatile family of lights designed to illuminate indoor and outdoor spaces in a variety of settings.

The conical head also extends to two bollard versions of different heights, providing uniform illumination for green spaces and pathways.

**Veia bollard 45**  
Ø150 x h 455 mm  
Total power: 9W  
3000K  
IP65

● Black grey

**Veia bollard 90**  
Ø150 x h 905 mm  
Total power: 9W  
3000K  
IP65

# Conus OBR



Conus is a collection of simple and functional outdoor lighting solutions, offering various installation types and a range of optical performances to provide the right illumination for multiple scenarios.

The collection includes a pole, two bollards of different heights and a stake, catering to diverse outdoor needs: marking pathways, creating expansive pools of light for gathering spaces, highlighting architectural features, details and natural focal points.

With its range of optical solutions and beam angles, Conus allows for dynamic lighting schemes tailored to architectural settings, green spaces and pathways.

Its design is iconic in the simplicity of its geometries, perfectly balanced for functional performance and

proportional aesthetics. The luminaire heads scale in size with their mounting height, available in diameters of 48, 60, and 80 mm, ensuring appropriate illumination levels.

Each head can rotate freely on two axes, allowing 360° light orientation in the space. The system offers a broad scope for lighting design, accommodating both regular and more visually striking arrangements.

The structure is minimal yet highly durable, making it ideal not only for private outdoor spaces but also for public environments.

The pole is suitable for different urban applications, like cycling or pedestrian paths.



**Conus spike**

head Ø48 x 85 mm

h 315 mm

Total power: 3,5W

S 20°, W 34°, WW 56°

3000K

IP65

**Conus bollard 45**

head Ø60 x 115 mm

h 460 mm

Total power: 7W

S 12°, W 34°, WW 55°

3000K

IP65

**Conus bollard 90**

head Ø60 x 115 mm

h 900 mm

Total power: 7W

S 12°, W 34°, WW 55°

3000K

IP65

● Black matte

○ Silver

● Black green

● Red



**Conus pole**

head Ø80 x 150 mm

h 2500 mm

Total power: 1 x 15W

asymmetric lens

3000K

IP65

**Conus pole 2 heads**

head Ø80 x 150 mm

h 2500 mm

Total power: 2 x 15W

asymmetric lens

3000K

IP65

○ Black matte

● Silver

● Black green

● Red



# Sintesi, 1975

## Ernesto Gismondi



### Sintesi wall

head 210 x 105 mm

130 x 270 x h 500 mm

wall accessory 15 x 130 x h 30 mm

Total power: 1 x 20W E27 LED

First introduced in 1975, the Sintesi lamp was the first Artemide product signed by its founder Ernesto Gismondi. Conceived as an intelligent system, it is built around simple, shared components that form a versatile family of designs. The table version serves as the foundation from which the entire system evolves.

A small bracket is added to the table version to fix it on the wall. The freedom of movement allows light to be brought into the space. A simple accessory opens up new functionality.

The table lamp structure is minimal yet adjustable in both angle and height, consisting of a few bent metal elements. Two C-shaped pieces of different lengths form the frame, with the shorter one connecting midway along the longer piece to create a Y-shaped support. By opening and closing, this structure allows the lamp to tilt.

○ White

● Blue

● Green

● Red

A frame surrounds the light source, holding and directing it. It features a universal E27 socket, ensuring adaptability over time and compatibility with evolving lighting technologies.

The frame also supports a reflector and a protective grid to shield the light source. Sintesi can be positioned in various ways to direct the light and can fold into itself for compact, flat packaging. Its project is direct and functional, shaped by a hands-on approach that lies at the heart of Ernesto Gismondi's design philosophy.

As an entrepreneur, engineer and designer, Gismondi approached each project with a broad perspective: he considered functionality, quality and measured design, along with mechanical aspects, efficient production and easy assembly.

Photo by Aldo Ballo



"It's like a magic formula and finding it is never guaranteed. You have to understand the needs of a particular moment in time. A product must be appreciated, meeting standards of beauty and harmony. But it also has to be manufactured and distributed, with the right price and market positioning."

Ernesto Gismondi

Photo by Pierpaolo Ferrari



**Sintesi**

head 210 x 105 mm  
130 x 270 x h 500 mm  
Total power: 1 x 20W E27 LED

- White
- Green
- Blue
- Red



Photo by Pierpaolo Ferrari

