

# Collection

**astep<sup>®</sup>**



Astep was founded in 2014 by Alessandro Sarfatti to create and curate timeless inventions projecting innovative ideas into the future. In the **Tribute Collection**, Astep reissues selected lighting designs as the timeless masterpieces of Gino Sarfatti in the Gino Sarfatti Collection and the works of established architects and designers who worked for Arteluce, the lighting company he founded. Acknowledging the importance of continuously redefining, refining and remembering timeless designs, Astep retains its edge by reintroducing new products with advancing technologies in the **Evolution Collection**.





Founder Alessandro Sarfatti by the family villa on Lake Como

**005 A Sarfatti Story**  
**006 The Astep Identity**

**Evolution Collection**

012 Isol  
018 Ublo  
022 Pepa  
026 Nox  
030 Candela

**Tribute Collection**

034 LT8  
038 VV Cinquanta  
056 SB Cinquantotto  
060 Model 2050

Gino Sarfatti Collection

066 Model 2065  
076 Le Sfere  
078 Le Sfere Transparent edition  
084 Le Sfere Model 237 / 238  
086 Le Sfere Model 2042  
092 Le Sfere Model 2109  
100 Le Sfere 1081  
102 Model 537  
106 Model 548  
110 Model 566  
114 Model 1095

**118 Designers**  
**122 Typologies**  
**124 Specifications**

I like to think of the essence of evolution as the capacity to capture the best of what has been and let it evolve into the heart of what is to come. Thus, Astep continues on the path devised by two great entrepreneurs. Like all good Italian tales, mine is also a family affair and draws from father to son.

In 1939, Gino Sarfatti, my grandfather, took the first step by founding Arteluce, a company that pioneered the use of design in the lighting business. In 1978 my father Riccardo went a step further. Together with my mother Sandra Severi and architect Paulo Rizzato he created Luceplan, a company that tied together design and technological research. This two-folds innovative and evolutionary legacy, together with an acute attention to sustainability, is what defines Astep. A company that looks into the future by reworking the meaning of history.

Astep is an international company. Based in Denmark, it has its roots and manufacturing capabilities in Italy. Merging the past and the future we revisit the most ground-breaking designs by Italian Masters and introduce new technologies into original ideas.

Because what made good design in the past is what continues to inspire us every day.

**Alessandro Sarfatti**  
Founder of Astep



## A Sarfatti Story

## Design

We believe that good design is timeless. It is made to outlive trends by expressing superior quality, beauty, and functionality in one, single idea. Good design is also about relationships. Behind a good project there is always a good relationship between all the people involved in the creative process of conception, development, manufacturing, marketing, and sale. A relationship of mutual trust and respect, fostered through the continuous exchange of ideas and visions and a joint goal of developing new solutions to add to the quality of life. We cherish our relations with those who work for us, with us, and who select our products. Each piece in the Astep Collection is connected in time by this bond of virtues, expressing the defining relationship between objects, people, and the spaces they inhabit.

## Sustainability

We are committed to circular design. Our products are designed to last and be loved for a lifetime. But also, to be repaired or refurbished if needed and, only as a last resort, recycled. We aim to, wherever possible, reduce the carbon footprint of our activities and act on it accordingly. By optimizing the use of cardboard, we have eliminated more than 90% of plastics in our packaging. We select materials that are good for our planet and use recycled and recyclable plastic in our lamps. We thrive to continuously seek new ways of improving and being more sustainable to cause minimal residual impact. Astep formally sent in the application of becoming a B Corp in March 2022 to add social and environmental good to profit. Our work ethic prizes clean manufacturing, artisanal quality, and social responsibility. For us good design and sustainable action essentially complement each other.

## Technology

We fuse design with technological advancement. Applying innovation at every step of the creative process, we aim to create products that represent a real evolution in the world of lighting. There was a time in which technological innovation was a privilege of large companies. In the last 20 years, though, digitalization and miniaturization have progressively changed the rules of the game. As the Maker's culture has demonstrated, innovation is now pervasive, affordable, ubiquitous, depending on people's wits and desire to change. Astep was born to merge the agility of new technologies with good design, to turn interventive innovation into aesthetically distinctive design devised from careful engineering.

# The Astep Identity

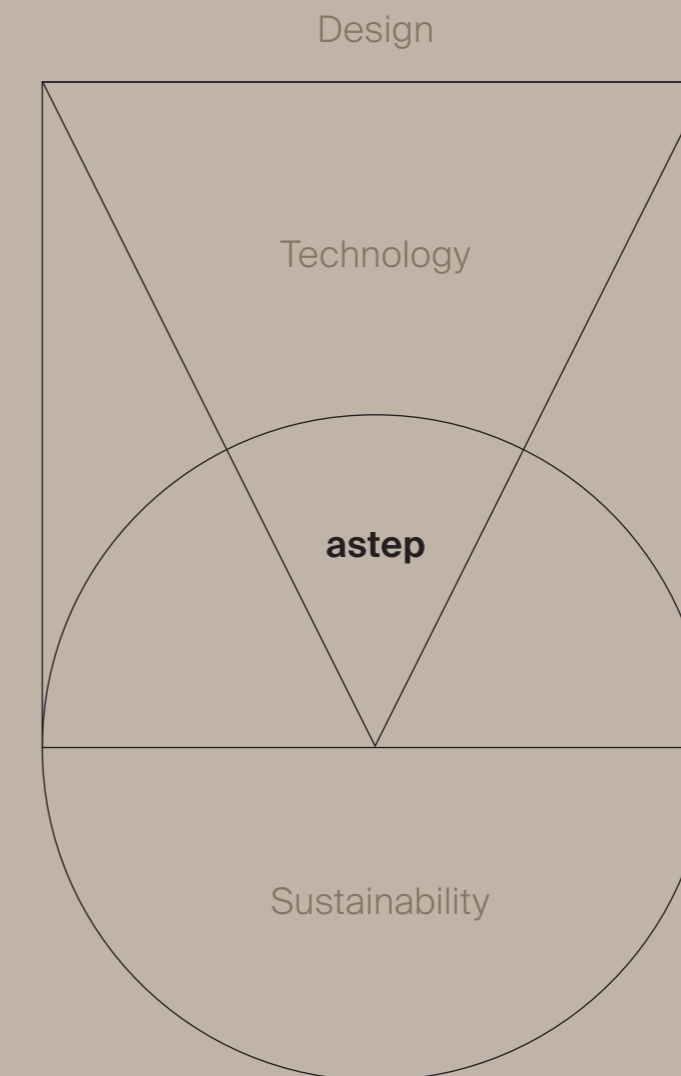

Good design feels eternally contemporary. As familiar as the past, as relevant as the present and as inventive as the future.

Good design is timeless. It draws from a relentless effort to go beyond what is possible. To excel, create, engineer.



This is where Astep moves, back and forth, bringing to life timeless designs and investing in contemporary inventions. An untiring quest into the innovative potentials of light and the sense of possibility each new piece may inspire.

The inventions of the past that are the icons of today meeting the icons of tomorrow that are the inventions of today.



# Evolution

Engaging the most forward-thinking designers, building on years of research, the Evolution Collection brings forward solutions that were not there before. Products with a prolonged life cycle for generations and with a refined aesthetic and manufacturing root in Italy. Merging innovation and high-end design to create new classics of today.

# Collection



David Thulstrup  
2021

# Isol







Designed by David Thulstrup with Snowsound® technology embracing the shape of a cylinder, Isol, offers elegant functionality pared down to its simplest expression.

Produced in Italy, the lamp is the result of high-precision work and technological advancement. The patented Snowsound® Fiber textile lends the lamp outstanding sound-absorbing qualities and acoustic performance. The fabric is completely recyclable and has a Greenguard Gold certification for being a low emitting product that contributes to improve indoor air quality.

Part sculpture and part light source, Isol can be used in a variety of combinations and in private and public environments as an aesthetic way of bringing acoustic properties into a space. Alone, it convinces through quiet authority offering a sense of privacy. In multiples, its distinctive character is enhanced by connecting the rings to extend lighting and noise-absorbing power.

A sound-absorbing acoustic high performance lamp developed with Snowsound® technology





David Thulstrup  
2023

# Ublo





Conceived for The Office Group in London, Ublo embodies architect David Thulstrup's impeccable visual and technical language within interior design.

Envisioned as an architectural element it expresses purity in form and function with clean geometric lines and smooth materiality that will gracefully fit all spaces.

The piece is meticulously engineered. Custom CNC-milled from solid aluminum, it is cut in one block that seamlessly conceals all technique while supporting the opal shade of injection molded polycarbonate. A sophisticated and high precision look and feel of quality deduced from function.

Expanding the small market of wet room fixtures, Ublo carries an IP44 rating to offer a distinct design choice for bathrooms and other environments where water spray is a risk factor. Supporting Astep's sustainability vision the lamp is further fully repairable and using replaceable G9 bulbs as light source.

Ublo is IP44 rated and offers a distinct design choice for bathrooms or other wet rooms

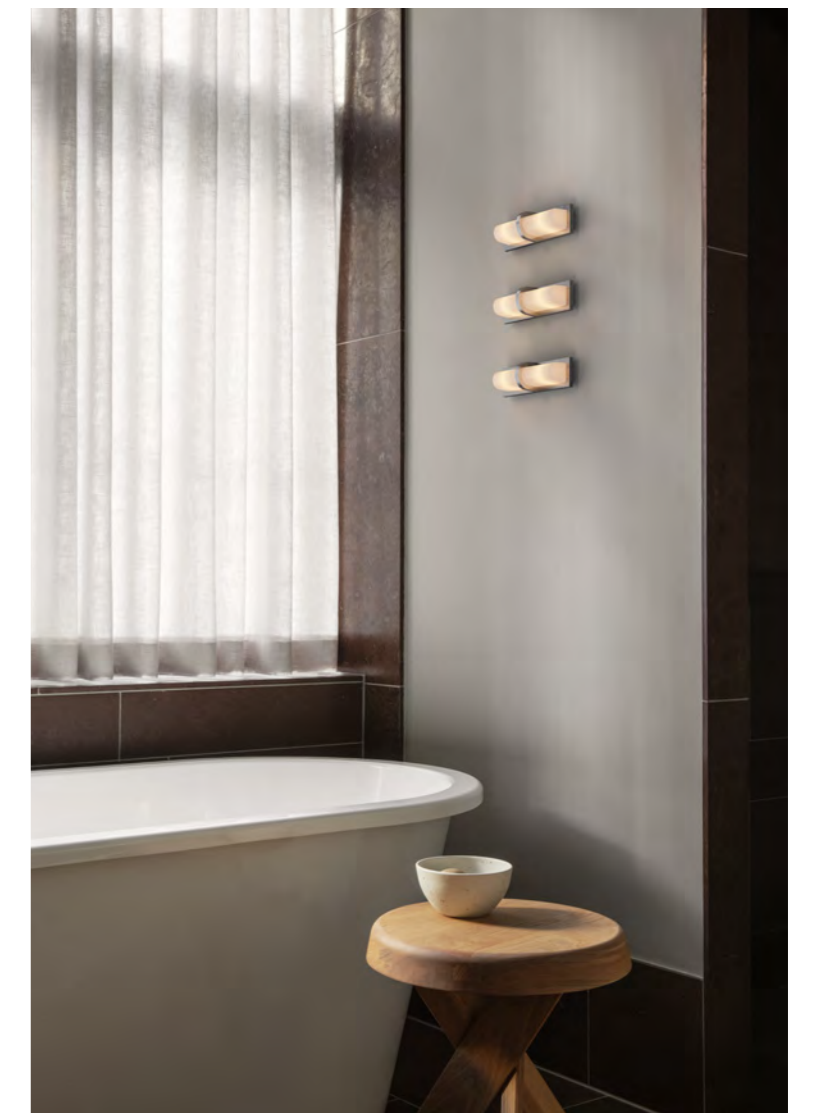



Francesco Faccin  
2020

Pepa



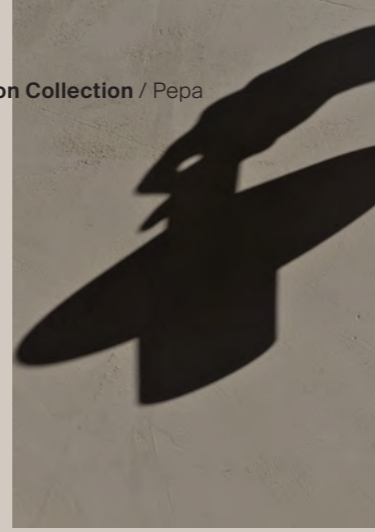

With a strong body of solid ash wood and powered by a technological heart, Pepa is a portable luminaire that marries traditional craft with modern technology. Pepa was born from the intuition of Italian designer Francesco Faccin to create a light that needs to be touched to be seen. Inspired by a pepper grinder, Pepa is held and twisted, up to 360°, to create a light that is finely adjusted and discreet or decisive whereas needed. Inside the beautifully finished wooden form, Pepa incorporates sophisticated multi-axis magnetic field sensor technology, which elegantly eliminates all wires inside and outside the product.

The thoughtful simplicity of construction ensures that Pepa has the longest life possible, making it a highly sustainable object. Unlike most other portable lamps, it is powered with USB-C connectivity through standard rechargeable batteries that can be purchased in any grocery store. Its parts, assembled with only four screws are all detachable and repairable, the circuit board can be easily substituted as it is not glued. At the end of the life cycle, all parts can be dismantled and recycled.

The distinctive shape and lantern-like dimensions of Pepa give it the versatility to adapt to diverse spaces and situations: on the dining table, next to the bed, on the balcony ... a humble wooden luminaire with long-lasting utility and premier elegance.





Alfredo Häberli  
2017

# Nox



Named for 'night' in Latin, Nox in its very essence invites being moved around to embellish and brighten up everyday life, both indoors and outdoors. The portable luminaire embodies the playful and innovative energy of Argentinian designer Alfredo Häberli in a softly beautiful shape that looks and feels precious.

Made and assembled in Italy of high-quality materials, Nox perfectly combines the artisan tradition of mouth-blown opal glass diffusers with advanced technology. The Lamp has an exceptional long duration due to its sophisticated wireless induction charging system. When fully charged at full intensity Nox provides up to twenty hours of light. At minimum intensity, it reaches astonishingly 336 hours (two entire weeks) of light. This performance makes it a unique case in the panorama of portable lamps.

Nox is simply recharged when set on its induction base or on any other charging base with Qi technology – a way to limit the excess of ad hoc charging tools and leave a sustainable imprint.



Distinctive to Nox is its wireless charging system with induction technology. Nox provides up to 336 hours of light when fully charged

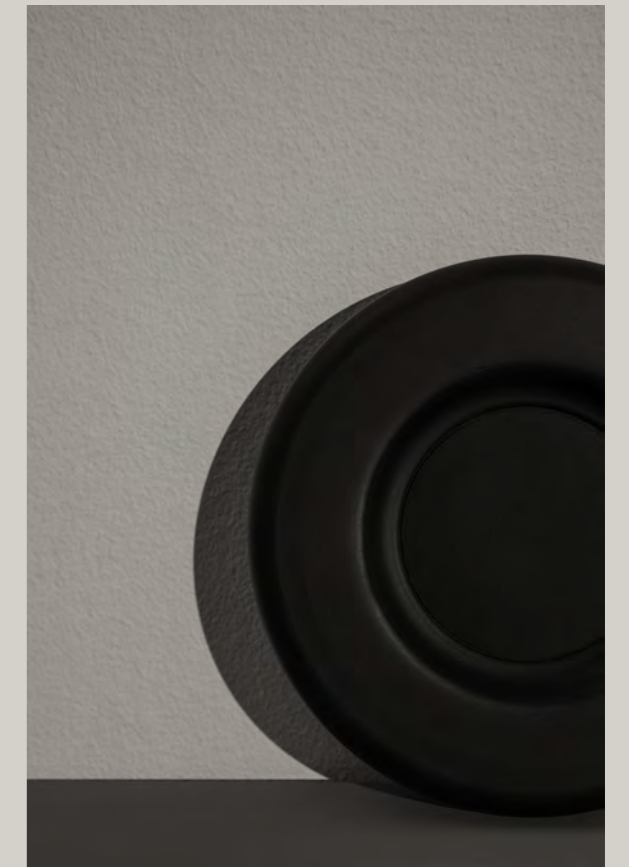





Exploring the essence of light, the flame, Candela perpetuates the tradition of Scandinavian oil lanterns by advancing the product with 21st century technology. The lamp expresses visionary designer Francisco Gomez Paz' inventive and curious approach to lighting. Igniting timeless rituals while pushing the limits of technology, to pursue a profound sense of beauty.

For Candela, Astep has crafted a novel energy harvesting system that generates electricity from the heat of the flame. Building on the thermoelectric Seebeck effect discovered in the 19th century, the lamp creates its own electricity to provide cosy LED illumination while charging mobile devices via USB.

Candela is powered by bioethanol, a clean, natural, and renewable fuel made from plants. Responsibly produced in Italy, the lamp is designed with recyclable materials such as aluminum and high-temperature advanced thermal materials. The wick is made from ceramic fibres coated with aluminium to prolong its life span. When lit, Candela generates a smokeless flame rising within the elegant shape of the hand-blown opal glass.

The portable lantern can be used both indoors and outdoors, ideal for a variety of spaces, such as cafés, restaurants, waiting rooms, and private homes.

Combining the oldest and newest forms of lighting in one piece, Candela is a manifesto that speaks to evolution in design and technology, and a heartfelt respect for the environment.

Francisco Gomez Paz  
2016

## Candela



A modern lantern harvesting energy  
from the flame of bioethanol

# Tribute

The lamps of the Tribute Collection celebrate the unrepeatable season of Italian masters who have combined design, technology, and manufacturing in a unique leeway. The lamps by Gino Sarfatti, Vittoriano Viganò, Osvaldo Borsani, Carlo Santi & Vittorio Borachia and Franco Albini & Franca Helg are a reference point for premium lighting design. They continue to be highly sought after due to their sophisticated, versatile soul and timeless looks. Astep pays homage to the tradition from which it draws inspiration to evolve by bringing back these iconic timeless pieces of the past enriched with today's technological advancements.

# Collection



LT8

Oswaldo Borsani  
1954 / 2023





An elegant and evocative presence of light enriching the space around it. LT8 is a stoic masterpiece of Italian modernist designer Osvaldo Borsani and a testament to his visionary ingenuity, that has continued to inspire designers up until this day.

LT8 was conceived in 1954 for Borsani's new company Tecno, that would come to revolutionize the world of contract furniture, and presented at the X Triennale in Milan. The lamp is a pioneering piece being one of the first hybrids of its kind, held in place suspended ceiling-to-floor. The extruded aluminium structure elegantly complements the legs in natural brass and highlights Borsani's acute attention to detail, both technical and aesthetic.

LT8 paved the way for later iconic suspended lighting designs. In 1957 the design of LT8 was deposited by Tecno S.p.A. as an ornamental and utility model to the Patent Office (release 09/11/1957, n. 64737) with the following description 'Lighting device with fluorescent tubes on support-diffuser adjustable around a longitudinal axis.' In Astep's re-edition the fluorescent tubes have been updated with an embedded dimmable LED module.

The design is as flexible as it is beautiful. You can direct the light source in any angle and orient it to where you want against the wall. The lamp comes in two heights to fit a wide range of spaces, public and private. Alone it stands as a sculpture, in pairs it becomes a landscape of light.



Born in 1951, the lamps of the VV Cinquanta family are among the greatest examples of timeless elegance and versatility of a product with Made in Italy design and manufacturing, a feature that they maintain unchanged in these re-editions.

Designed by the architect Vittoriano Viganò, whom Gino Sarfatti trusted for the art direction of Arteluce, they are characterized by essential and refined lines and maximum functionality. The light of VV Cinquanta can be direct or indirect. By rotating or tilting the diffuser, the lamp meets the most diverse needs, from work and reading to ambient lighting.

The Floor model stands gracefully on a slim black aluminum frame. The spun aluminum reflector is mounted on an articulated stem that can rotate and tilt, allowing for different lighting scenarios. The Wall model is mounted on a brass device that allows the reflector to rotate 350° and can be angled 160°. The Twin model is an elegant wall lamp with two brass arms: mounted on a bracket of the same material, they extend in opposite directions, defining a sculptural design with multiple luminous compositions. In the Suspension model, the versatility of lighting becomes maximum thanks to a dynamic and playful design that invites you to act on the double stem defining infinite compositions, like real domestic architectures that stretch from the ceiling. Each of the two stems culminates with two different turned aluminum reflectors available in the colors designed by Viganò, one narrow and one wide.

They can all assume multiple and ever-changing positions, for both downward and upward lighting, direct or indirect, finding their own equilibrium.

Vittoriano Viganò  
1951 / 2016

## VV Cinquanta





Vittoriano Viganò  
1951 / 2016

# VV Cinquanta Wall







Vittoriano Viganò  
1951 / 2017

# VV Cinquanta Twin





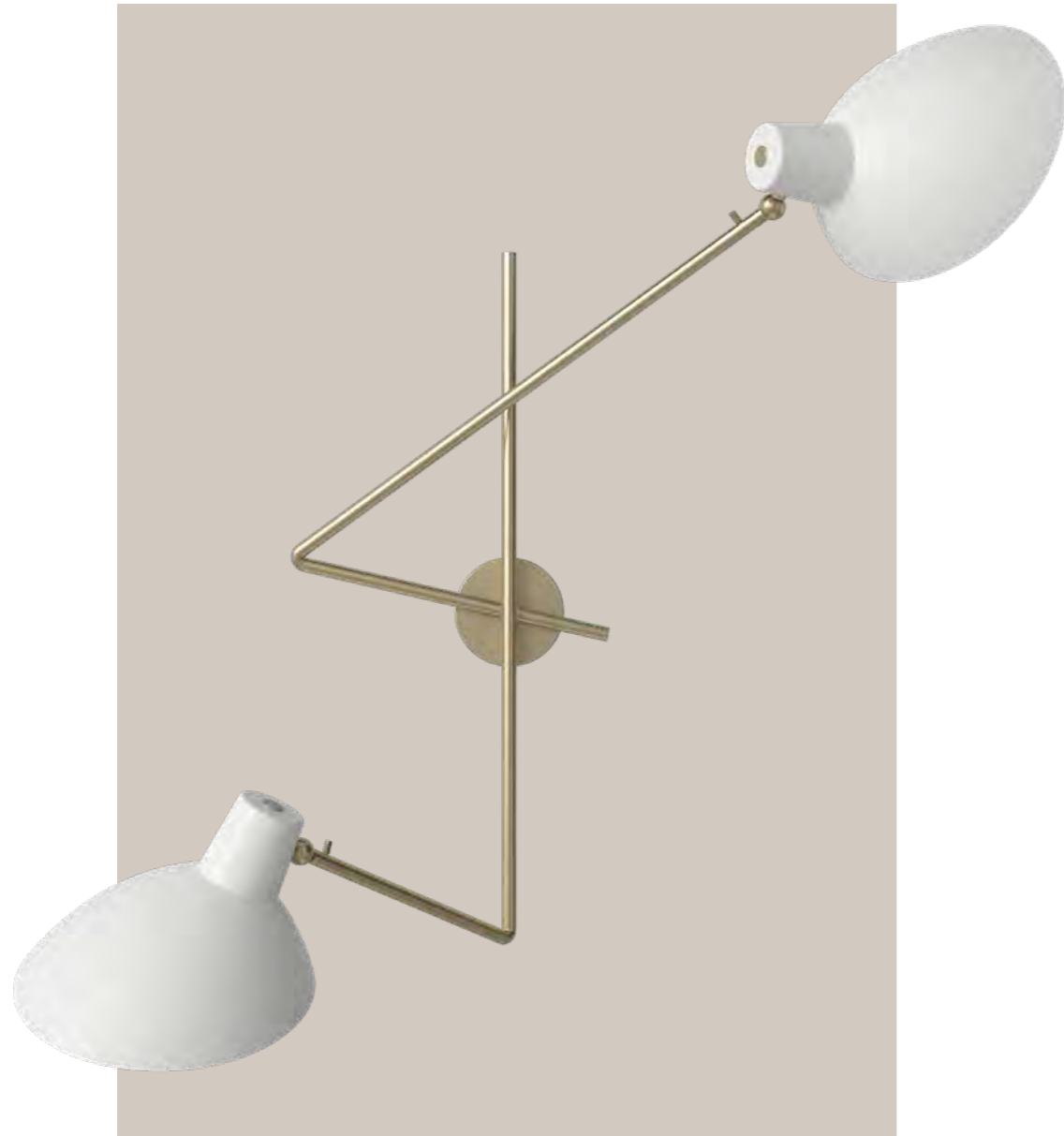

A sculptural wall lamp with multiple lighting compositions



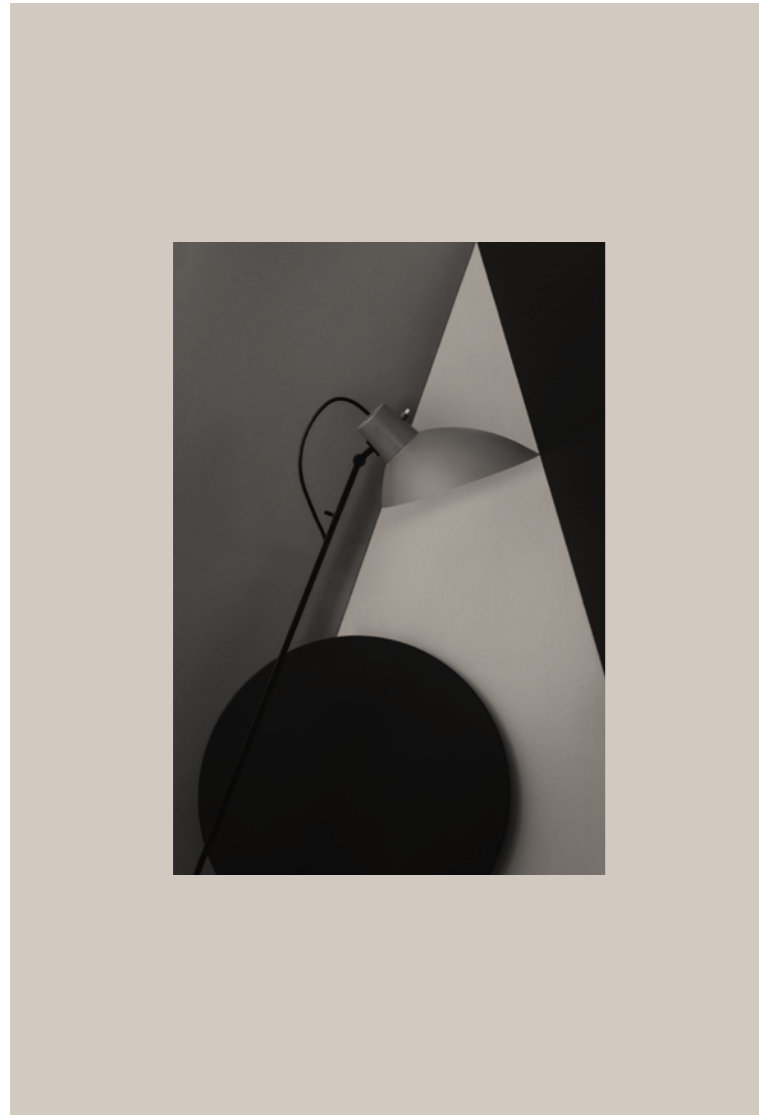

Vittoriano Viganò  
1951 / 2016

# VV Cinquanta Floor



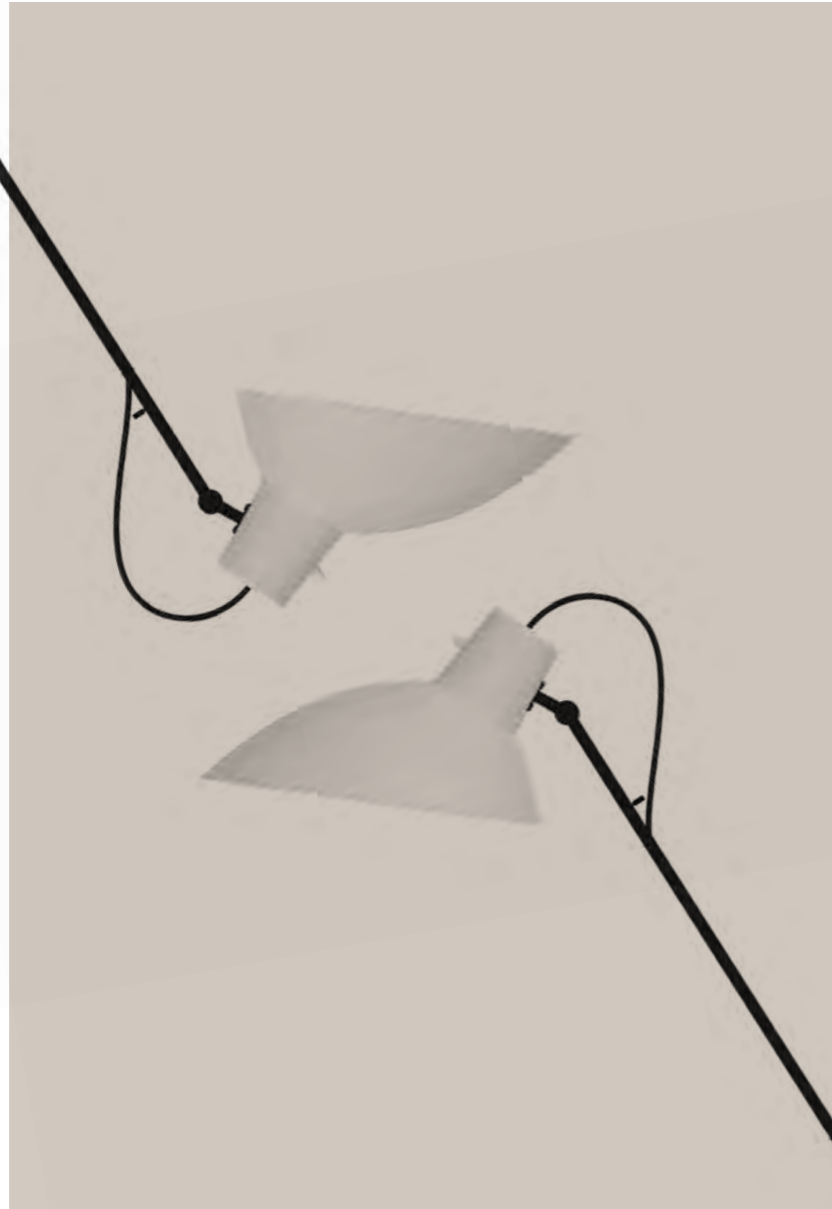



Vittoriano Viganò  
1951 / 2016

## VV Cinquanta Suspension



Carlo Santi & Vittorio Borachia  
1958 / 2019

# SB Cinquantotto



SB Cinquantotto is a design masterpiece that comes from afar and brings the emotion of a family history into the contemporary world.

Designed in 1958 for Arteluce by the architects Carlo Santi and Vittorio Borachia, the prototype of this perfect example of the finest Italian manufacturing has for years embellished the Lake Como home of Gino Sarfatti, founder of Arteluce and grandfather of Alessandro, Astep's founder. Recovered by Alessandro, who knew of its design qualities and its manufacturing of excellence since he was a child, it is re-proposed following the original design, like a suspension in satin opal glass hand blown in Italy.

The timeless aesthetic of the thin diffuser, perfect for elegantly illuminating any environment, meets the mounting system based on the pattern generated by a black cable that runs freely next to an almost transparent aluminum wire.

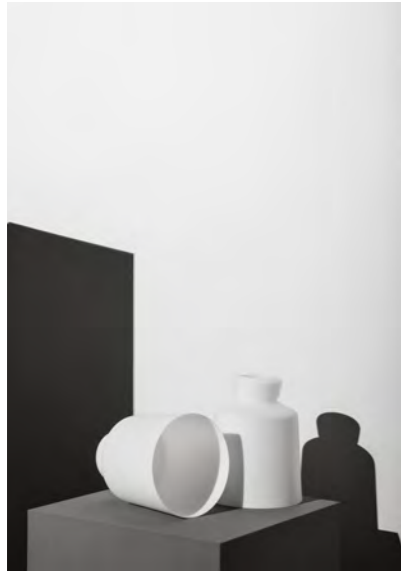

Franco Albini & Franca Helg  
1963 / 2021

# Model 2050







In 1963, Franco Albini and Franca Helg started experimenting with plastics in lighting for Arteluce. Summoned by Gino Sarfatti to research the possibilities that new technologies and materials were providing, the two designers came up with a suspension lamp that summed up the two souls of the Arteluce brand: the love for glass, which they used for the opal diffuser, and the daring use of methacrylate, a (then new) lighter and more resistant material, perfect to interpret modernity by combining craftsmanship and industry.

With the re-edition of this iconic lamp, Astep continues its work of rediscovery of great Italian masters of light while also pursuing the same pioneering spirit in materials research that animated Albini, Helg and Sarfatti. It does so by bringing environmental sensitivity into the equation through using Green Cast, a material that is 100% recycled and recyclable, patented and made in Italy, featuring identical properties of classic methacrylate. With its brushed finish, the Green Cast used for the new 2050 diffuser restores a timeless elegance. For Astep sustainability is also about guaranteeing performance and aesthetics.







Gino Sarfatti  
1950 / 2016

# Model 2065



A timeless masterpiece of lightness and elegance, Model 2065 is the result of Gino Sarfatti's desire to experiment with materials.

Gino Sarfatti came across methacrylate samples between 1949 and 1950. This convinced him to create a suspension lamp with this plastic polymer which is much lighter and more resistant than glass. The 2021 version adds to these features in terms of sustainability: it is made of Green Cast®, a 100% recycled and recyclable PMMA (polymethyl methacrylate) – patented and made in Italy – that has exactly the same aesthetic and functional quality of the original methacrylate. Model 2065 consists of a diffuser made up of two opalescent plates joined and suspended from the ceiling with a black painted aluminum rosette. A simple design played on the elliptical shape and the lightness of the materials which, together, seem to give life to a weightless creation.

The lamp was relaunched by Astep in 2016 in also a second black version, in which the upper plate is finished with a soft-touch coating with a strong graphic expression. Five E14LED bulbs provide illumination in all versions of the lamp.







Gino Sarfatti  
1955 / 2021

# Model 2065 Wall



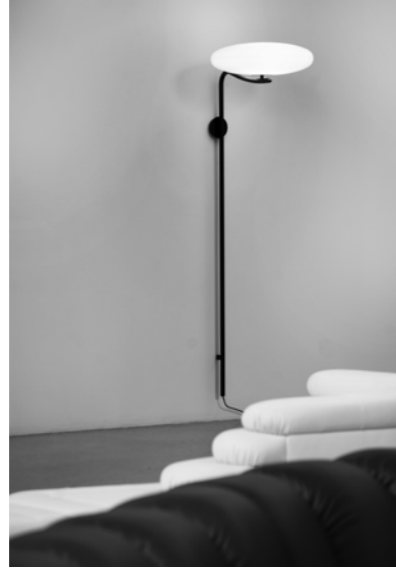

The ceiling Model 2065 was already an innovative statement in the world of lighting of the 50s. The Wall Model added the extraordinary capacity to re-write the formal status quo for its category: with the cables fitting inside its tube, it was stuck to the wall yet also nomadic and required no architectural or electrical intervention.



Throughout his life, Gino Sarfatti was fascinated by the sky, and especially by the perfect light emanating from the moon. Le Sfere Collection is a testament to this special attraction of his.

Conceived from 1959, it is a family of opaline glass lamps revolving around a single blown luminous sphere held in place by a painted aluminium ring. A simple, yet elegant principle and a refined embrace that lends the luminaire a graphic expression to bring forth its distinctive aesthetic.

From Model 237, consisting of a single sphere, to Model 2109, that of the iconic twenty-four-sphere chandelier, this family of luminaires, the largest designed by Sarfatti, was gradually expanded to fit larger commissioned projects. Among them is the famous Teatro Regio in Turin, Italy, designed by architect Carlo Mollino, where Le Sfere can still be seen in a variety of compositions, including generous 'cloudlike' cascades and columns, curated by Sarfatti, which emphasize the genius and beauty of the system.

But above all, Le Sfere is a multifaceted and open lighting system, suitable for all types of spaces, created from the same fundamental principle: a beautiful interpretation of the perfect luminous sphere.



Le Sfere

Gino Sarfatti







## Introducing Le Sfere Transparent

Bringing back a classic design we introduce Le Sfere in clear glass. Originally conceived by Gino Sarfatti as part of the Sfere family of luminaires this addition adds to the luxurious depth and versatility of the collection. The sophisticated airiness of the transparent glass combined with the distinctive black finish makes it a beautiful accent light in any space.







Gino Sarfatti  
1959 / 2018

Model 237  
Model 238  
1 or 2 Spheres





Gino Sarfatti  
1963 / 2020

Model 2042 <sup>3 spheres</sup>

Gino Sarfatti  
1963 / 2019

# Model 2042 6 spheres





Model 2042 6 spheres

Gino Sarfatti  
1963 / 2019

Model 2042 9 spheres





Gino Sarfatti  
1959 / 2018

Model 2109 <sup>12/14</sup>





Gino Sarfatti  
1959 / 2018

# Model 2109 <sup>16/14</sup>



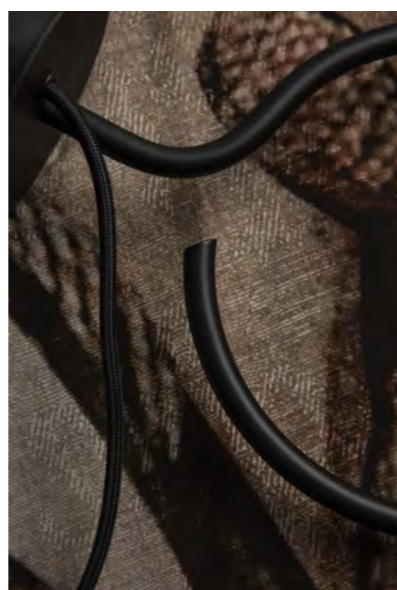

Gino Sarfatti  
1959 / 2018

# Model 2109 <sup>24/14</sup>





Gino Sarfatti  
1959 / 2018

Model 2109 <sup>16/20</sup>





Gino Sarfatti  
1959 / 2023

# Model 1081





Gino Sarfatti  
1950 / 2019

# Model 537





At the origin of any model of portable lamp, there is this exceptional creation which reflects the genius and mastery of Gino Sarfatti, well ahead of his time. Model 537, designed around 1950, is a masterpiece reintroduced by Astep.

In its simplicity, this lamp stands out for the combination of fine materials and its ingenious and ironic design. The large aluminum reflector is mounted asymmetrically on a burnished or polished brass stem, which is carefully twisted, coming to rest on the marble base. The stem extends through the reflector and beyond with a backward movement, giving the upper part of the stem a dual function of playful element and practical handle that anticipates the integrated handle of contemporary portable lights by years.

Model 537 is easily carried by hand from the desk to the living room, to the bedroom to any other environment, illuminating it with genius and design.



A lamp that anticipates and suggests the idea of portability



Gino Sarfatti  
1951 / 2013

# Model 548



Lighting conceived as a sophisticated game of screens, in perfect balance between direct and indirect light. Gino Sarfatti designed the Model 548 in 1951 giving vent to one of the themes that were most dear and congenial to him.

For this table lamp, he used a spotlight that can be oriented towards a reflective screen formed by the large diffuser in methacrylate. The interaction between spotlight and screen defines a sophisticated effect, poised between lighting and perception. The spotlight in white painted aluminum is mounted on a tubular stem in polished or burnished brass, while a small brass bar at the base acts as a counterweight in the beautiful balancing of the individual elements.

The re-edition is repairable, and the original incandescent bulb has been replaced by an LED source and an optical dimmer switch is discretely integrated into the original design.







Gino Sarfatti  
1956 / 2020

# Model 566





A simple and iconic task lamp. Designed in 1956, Model 566 by Gino Sarfatti is a masterpiece of minimalism and refinement, a tribute to the simplicity of the light bulb. The classic Cornalux bulb (no longer in production) has been replaced for this re-edition with a special and modern low energy consumption and long lasting LED technology.

Playing on the geometry designed by the inclined stem and the tube that mounts the bulb, the Model 566 generates a perfect light for working, studying or reading.

The tube is supported by a rubber ring that allows it to be oriented in infinite positions. The switch positioned on the base, faithful to the original model, is a further note from the past that returns in a contemporary key.





Gino Sarfatti  
1968 / 2023

Model 1095



Astep reintroduces the iconic floor lamp Model 1095 designed by Gino Sarfatti in 1968 in a reengineered and repairable version true to its original design.

The lamp is slender, graceful, and intriguing in its disproportions between head and base. The design of the small reflective cup was strongly influenced by the then-new halogen light bulb, which Gino Sarfatti explored and celebrated in Model 1095 from both a functional and a dimensional perspective.

In this re-edition the lamp is now dimmable. Offering indirect light in a subtle design, the luminaire is made up of a tubular aluminium stem available in three different heights and painted slate grey. The small reflective cup with its thin shape is made of white-painted aluminium, and so is the base with the appealing soft shape.





## Gino Sarfatti

Designer (1912-1985)

Gino Sarfatti is one of the most significant figures in the history of Italian industrial design. Throughout his career he developed more than 700 luminaires as the creative engine behind Arteluce, the company he founded in 1939 which brought lighting into the 20th century combining innovative ideas with groundbreaking design.

Born in Venice in 1912, Gino Sarfatti studied to become an aeronautical engineer until family circumstances compelled him to relocate to Milan where he had his first encounter with lighting, an engineering project to transform a glass vase into a lamp. This encounter with lighting design and engineering shaped the path of his life.

Throughout his career, Gino Sarfatti explored and was inspired by new product typologies, innovative materials, lighting technologies, and production techniques. His hybrid and entrepreneurial talent as a designer and engineer enabled him to create refined products in both aesthetics and function.

In 1973 Gino Sarfatti retired to the family villa on Lake Como, home to many of the original designs.



## Carlo Santi and Vittorio Borachia

Architects and designers (1925-2004 / 1920-2015)

Carlo Santi (1925-2004) and Vittorio Borachia (1920-2015), who make up the architectural duo Santi Borachia, met while they were both students at the Polytechnic School in Milan during the 1940s and found common ground for exploring the world of architecture and design.

Among other collaborations, the duo was involved in the lighting company Arteluce, which at the time attracted the most talented architects and designers due to the visionary and experimental approach of its founder, Gino Sarfatti. Later, Carlo Santi's and Vittorio Borachia's spheres of interest moved on to urban planning, but from time to time they continued the exploration of lighting and furniture design, both as a duo and under their own names. Carlo Santi and Vittorio Borachia were guided by the logical and formal principles of the most recent industrial techniques and materials and aimed for an essential elegance in their design, whether in plastic, wood or glass.



## Vittoriano Viganò

Architect and designer (1919-1996)

For Vittoriano Viganò all design practices shared the same similarities, being vehicles for human development and a social commitment to improve the quality of life for all. Bridging various scales: from industrial design to architecture, from interior design to urban planning, Viganò's multidisciplinary talent has acquired international resonance, unanimously considered by critics the most important Italian exponent of the 'Brutalism' current.

Growing up in a creative environment as the son of the painter and engraver Vico Viganò, Vittoriano would himself turn towards architecture during his studies, graduating from the Politecnico di Milano in 1944. When opening his studio, he started a close cooperation with his friend Gino Sarfatti, first as advisor and later as Art Director of Arteluce, the company founded by Sarfatti. During this time, he designed the flagship store in Via della Spiga in Milan and made important design contributions to Arteluce, such as the VV Cinquanta family of luminaires with metal cones projecting ambient light along articulated arms. In 1991 the San Luca Academy awarded him the Italian Republic President Prize for Architecture.



## Franco Albini & Franca Helg

Architects (1905-1977 / 1920-1989)

Franco Albini (1905-1977) was a great Italian architect, a leading figure of Rationalism, one of the undisputed fathers of industrial design. His projects, the result of the partnership with Franca Helg (1920-1989), range from large to small scale, from the arrangement of the stations of the Milan Metro line 1 together with graphic designer Bob Noorda to the realization of urban, building and museum interventions all Italy.

In design, Albini and Helg have linked their name to timeless furnishings and accessories, innovative in their design approach and in the choice of materials. Their production represents an internationally recognized cornerstone of the innovation of design culture at the beginning of the twentieth century.



## Osvaldo Borsani

Architect and designer (1911-1985)

A creative pioneer, visionary entrepreneur, and technological innovator. Designing products until the early 1980s, Borsani is widely regarded as one of the most prominent figures in the era of Italian modernism.

Growing up in a creative environment, being the son of a cabinet maker, he would study Beaux-Arts and train as an architect in Milan while the city was a flourishing artistic center of design and technological progress, merging craftsmanship and modern manufacturing.

In 1953 Borsani founded Tecno together with his twin brother Fulgenzio. A company that would take a leading position and change the world of contract furniture in the 20th century with distinctively elegant designs, using innovative technology to express original ideas.



## Alfredo Häberli

Designer (1964)

For many years, Zurich has been home to Alfredo Häberli and his playful design developments. Before resettling in Switzerland with his family in 1977, Alfredo grew up in Argentina, and his work is strongly influenced by his childhood experiences and native country.

He works with great emotion, energy and curiosity and benefits from having a visionary mindset, a serious attitude and a keen sense of details. The result is a collected work imbued with a strong expression and inherent emotionality and beauty.

Alfredo Häberli graduated, with distinction, as an industrial designer in 1991 and effortlessly combines tradition and innovation in every aspect of his work. He has been granted numerous awards and honours, including 'Guest of Honour' at the 20th Biennale of Design in Kortrijk (2006) and the 'Swiss Grand Prix of Design' (2014) by the Swiss Federal Office of Culture.



## Francesco Faccin

Designer (1977)

Constantly shifting the area of application between industrial production, independent production, community design and gallery work, Francesco Faccin, believes in design without boundaries or limits: "I am interested in design that sparks connections, thought and debate, above all those that are a product of in-depth studies beyond the object itself. Design is a fantastic opportunity to deepen our relationship with the world around us."

Born in Milan in 1977. In 2004, after a collaboration lasting almost 2 years with Enzo Mari, he began to work with the lute-maker Francesco Rivolta. In 2007 he started his own studio in Milan. From 2009 to 2015 he was consultant for Michele De Lucchi.

Studio Francesco Faccin collaborates on a regular basis with Italian and international clients such as design galleries (Rossana Orlandi, Nilufar), private companies, public institutions, and NGOs.



## Francisco Gomez Paz

Designer (1975)

Born in Salta in Argentina in 1975, Francisco Gomez Paz moved to Milan after completing studies in Industrial Design at the Universidad Nacional de Cordoba. In 2004 he opened his design studio in Milan.

Driven by a curiosity and knowledge of technology and materials, and complimented by his highly experimental hands-on creative process, Francisco Gomez Paz has developed products for a wide range of leading design companies.

His work has received several international recognitions including the Good Design Award and the Red Dot Award, both in 2010. Together with Alberto Meda, Francisco Gomez Paz was awarded the First Prize of the Index Award for the Solar Bottle, which has also been selected for the Study Collection at MOMA. In 2011 he won the Prize of Prizes to Innovation in Design for the Hope chandelier, followed by the prestigious Compasso d'Oro 2011. Works and lives between Milan and Salta.



## David Thulstrup

Architect and designer (1978)

The award-winning Danish designer David Thulstrup brings his extensive experience as an architect and interior designer to furniture and lighting design. Honest thoughtful use of materials and clarity of purpose are paramount.

Using architecture and context as a starting point he creates simple well-crafted pieces that are distinctive in their form and fit harmoniously in the overall space. Applying a holistic approach to his practice, David often creates furniture and lighting for specific projects but always with the intention that they can belong anywhere. Although contemporary in their expression they are designs that will stand the test of time, combining his Scandinavian heritage with a modern design language.

# Typologies

## Portable

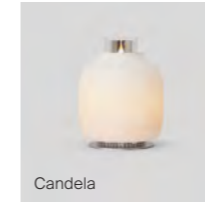

Candela



Nox



Pepa

## Table



Model 548



Model 537



Model 566

## Floor



VV Cinquanta Floor

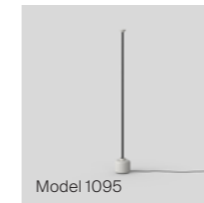

Model 1095



Model 1081



LT8

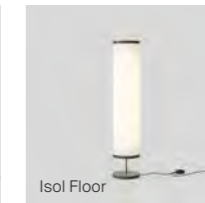

Isol Floor

## Suspension

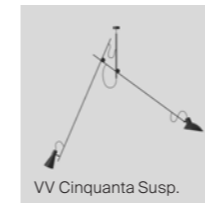

VV Cinquanta Susp.



Model 2065

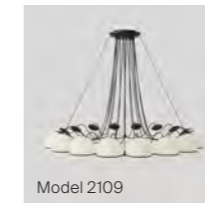

Model 2109

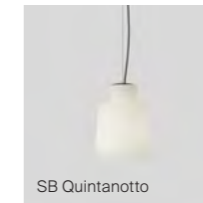

SB Quintanotto

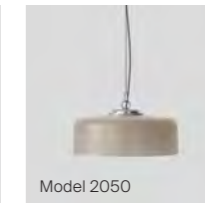

Model 2050



Isol

## Ceiling



Model 2042 / 3



Model 2042 / 6



Model 2042 / 9

## Wall



VV Cinquanta Wall



VV Cinquanta Twin



Model 237/238 / 1



Model 237/238 / 2

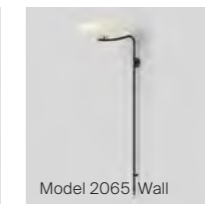

Model 2065 Wall



Ublo Wall

# Specifications

## Isol 30

David Thulstrup, 2021

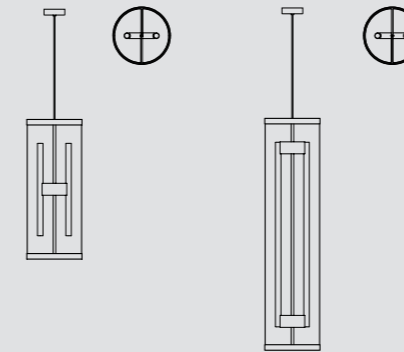

**Typology** Suspension  
**Materials** Aluminium Structure, Acoustic Absorbent Fabric  
 Diffuser with Snowsound® Technology  
**Dimensions** ø 300 x 760mm / ø 300mm x 1260mm  
**Diffuser Diameter** ø 300mm  
**Cable Length** 3000mm

Bulbs Not Included



Item Code	Description	Weight	Light Source
A04-S51-S00B	30/76 Black	3.00kg	2 x S14d (8W Max)
A04-S51-S00C	30/76 Cream	3.00kg	2 x S14d (8W Max)
A04-S61-S00B	30/126 Black	4.70kg	2 x S14s (12W Max)
A04-S61-C00C	30/126 Cream	4.70kg	2 x S14s (12W Max)

## Isol 30 Floor

David Thulstrup, 2023

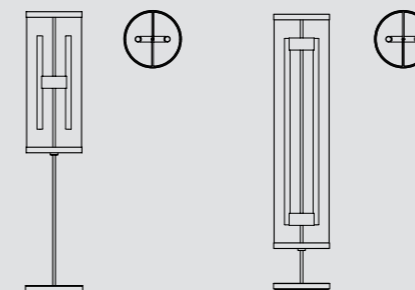

**Typology** Suspension  
**Materials** Aluminium Structure, Acoustic Absorbent Fabric  
 Diffuser with Snowsound® Technology  
**Dimensions** ø 300 x H1480mm  
**Diffuser Diameter** ø 300  
**Control** Foot Dimmer

Bulbs Not Included



Item Code	Description	Weight	Light Source
A04-F51-S00B	30/76 Black	7.50kg	2 x S14d 500mm (8W Max)
A04-F51-S00C	30/76 Cream	7.50kg	2 x S14d 500mm (8W Max)
A04-F61-S00B	30/126 Black	8.00kg	2 x S14s 1000mm (12W Max)
A04-F61-S00C	30/126 Cream	8.00kg	2 x S14s 1000mm (12W Max)



## Candela

Francisco Gomez Paz, 2016

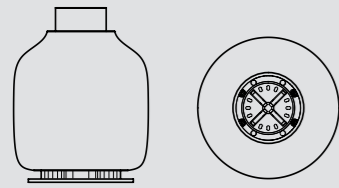

<b>Typology</b>	Table
<b>Materials</b>	Opaline Glass Diffuser, Aluminium Body
<b>Dimensions</b>	ø 186 x 241mm
<b>Diffuser diameter</b>	ø 186mm
<b>Weight</b>	2.70kg
<b>Light source</b>	Integrated LED 1.5W 2200K
<b>Charging system</b>	Bioethanol Fuel
<b>Connector</b>	USB Type A
<b>Battery</b>	3400mAh Lithium Polymer
<b>Fuel Capacity</b>	260 ml
<b>Duration</b>	5hrs



Item Code	Description
A01-T10-200W	Light & Charge

## Pepa

Francesco Faccin, 2020

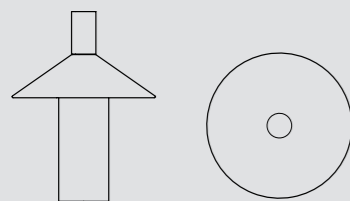

<b>Typology</b>	Table
<b>Materials</b>	Solid Ash Wood, Stainless Steel
<b>Dimensions</b>	ø 206 x 273mm
<b>Cable length</b>	1500mm
<b>Weight</b>	1.40kg
<b>Control</b>	Rotary Dimmer
<b>Light source</b>	Integrated LED 2W 330lm 2200K
<b>Charging System</b>	USB Cable
<b>Connector</b>	USB Type C
<b>Battery</b>	6 x AA Rechargeable NiMH 2600mAh Batteries Recommended Batteries Not Included
<b>Duration</b>	7hrs



Item Code	Description
A03-T12-00T0	Natural Ash Wood

## Ublo Wall

David Thulstrup, 2023

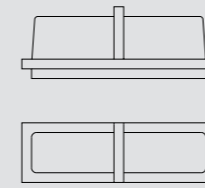

<b>Typology</b>	Wall
<b>Materials</b>	Opaline Polycarbonate Diffuser, Raw or Anodized Aluminum Structure
<b>Dimensions</b>	W62 x D200 x H74mm
<b>Light source</b>	2 x G9 (6W Max)
<b>Weight</b>	0.60kg
	Bulbs Not Included



Item Code	Description
A05-W71-200A	White Diffuser, Raw Aluminum Structure
A05-W71-200B	White Diffuser, Black Structure

## Nox

Alfredo Häberli, 2017

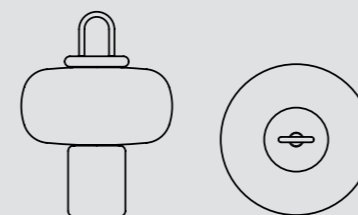

<b>Typology</b>	Table
<b>Materials</b>	Opaline Glass Diffuser, Aluminium Body
<b>Dimensions</b>	ø 224 x 305mm
<b>Diffuser diameter</b>	ø 224mm
<b>Weight</b>	2.50kg
<b>Control</b>	Touch dimmer
<b>Light source</b>	Integrated LED 5W 400lm 2200K
<b>Charging system</b>	Wireless Induction Requires Charging Base
<b>Battery</b>	16000mAh Lithium Polymer
<b>Duration</b>	20-336hrs Requires Accessories



Item Code	Description
A02-T12-000B	Black
A02-T12-000G	Silver

## Nox Charging Base

Optional accessory

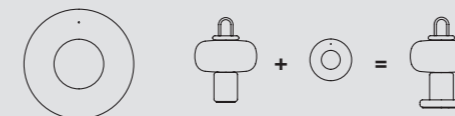

Item Code	Description
A02-A01-000B	Black
A02-A01-000G	Silver

## SB Cinquantotto

Carlo Santi & Vittorio Borachia, 1958/2019

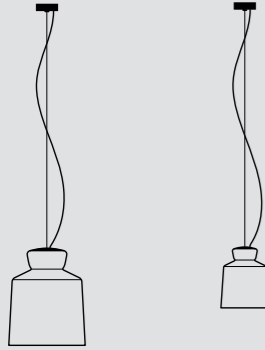

<b>Typology</b>	Suspension
<b>Materials</b>	Opaline Glass Diffuser, Steel Structure
<b>Dimensions</b>	ø 320 x H410mm / ø 200 x H260mm
<b>Cable Length</b>	2000mm
<b>Weight</b>	4.10kg / 1.30kg
<b>Light source</b>	1 x LED Bulb Complimentary Bulb Included *



Item Code	Description	Installed Height	Weight	Socket	Wattage Max
T10-S21-00BW	32cm Diffuser Diameter	610-2350mm	2.62kg	E27	60W
T10-S31-S0BW	20cm Diffuser Diameter	480-2200mm	1.45kg	E14	40W

## LT8

Oswaldo Borsani, 1954/2023



<b>Typology</b>	Floor
<b>Materials</b>	Extruded Aluminum Structure, Brass Legs
<b>Dimensions</b>	W128 x D119 x H2300-2900mm
<b>Cable Length</b>	3500mm
<b>Control</b>	Rotary Dimmer
<b>Light source</b>	Integrated LED 3000K



Item Code	Description	Installed Height	Weight	Illumination Lumens	Illumination Wattage
T13-F11-011W	2030mm White Structure	2300-2900mm	11.0kg	2508lm	23W
T13-F11-021W	2030mm White Structure	2900-3500mm	13.5kg	3450lm	31.7W

## Model 2050

Franco Albini & Franca Helg, 1963/2021

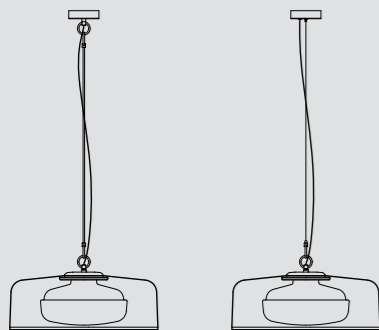

<b>Typology</b>	Suspension
<b>Materials</b>	Opaline Glass Diffuser, Methacrylate Diffuser, Steel Structure
<b>Dimensions</b>	ø 590 x 296mm
<b>Diffuser diameter</b>	ø 590mm
<b>Weight</b>	5.25kg
<b>Light source</b>	1 x E27 (LED 11W Max) 1521lm 2700K Complimentary Bulb Included *



Item Code	Description	Installed Height	Cable Length
T12-S21-000N	Rod Suspension, Smoke Diffuser	1250mm	
T12-S21-000W	Rod Suspension, Pearl Diffuser	1250mm	
T12-S21-W00N	Wire Suspension, Smoke Diffuser	450-3400mm	3000mm
T12-S21-W00W	Wire Suspension, Pearl Diffuser	450-3400mm	3000mm

## VV Cinquanta / Wall

Vittoriano Viganò, 1951/2016

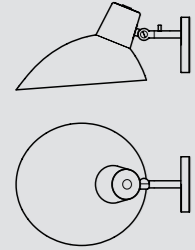

<b>Typology</b>	Wall
<b>Materials</b>	Spun Aluminium Reflector, Brass Mount
<b>Dimensions</b>	W256 x D364 x H183mm
<b>Reflector diameter</b>	ø 274mm
<b>Weight</b>	0.70kg
<b>Control</b>	Available with On/Off Switch
<b>Light source</b>	1 x E27 LED 7W (53W Max) 806lm 2700K Complimentary Bulb Included *



Item Code	Description	Control
T02-W21-00BB	Black Mount, Black Reflector	None
T02-W21-00BW	Black Mount, White Reflector	None
T02-W21-00BR	Black Mount, Red Reflector	None
T02-W21-00BY	Black Mount, Yellow Reflector	None
T02-W21-0018	Brass Mount, Black Reflector	None
T02-W21-001W	Brass Mount, White Reflector	None
T02-W21-S0BB	Black Mount, Black Reflector	On/Off Switch
T02-W21-S018	Brass Mount, Black Reflector	On/Off Switch
T02-W21-S01W	Brass Mount, White Reflector	On/Off Switch

## VV Cinquanta / Twin

Vittoriano Viganò, 1951/2016

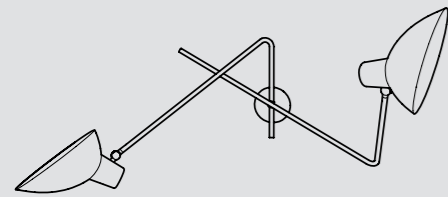

<b>Typology</b>	Wall
<b>Materials</b>	Spun Aluminium Reflectors, Brass Structure
<b>Dimensions</b>	W1130 x D538 x H524mm
<b>Reflector diameter</b>	ø 274mm
<b>Weight</b>	5.80kg
<b>Light source</b>	2 x E27 LED 7W (53W Max) 806lm (1612lm Total) 2700K Complimentary Bulbs Included *



Item Code	Description
T02-W21-1BBB	Black Mount, Black Reflectors
T02-W21-11BB	Brass Mount, Black Reflectors
T02-W21-11WW	Brass Mount, White Reflectors

## VV Cinquanta / Floor

Vittoriano Viganò, 1951/2016

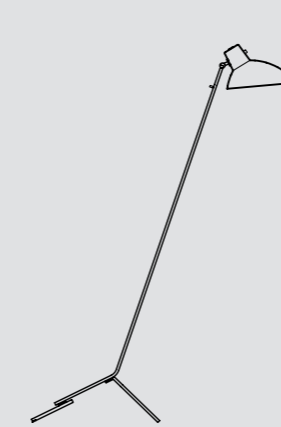

<b>Typology</b>	Floor
<b>Materials</b>	Spun Aluminium Reflector, Steel or Brass Frame
<b>Dimensions</b>	W487 x D1035 x H1470mm
<b>Reflector diameter</b>	ø 274mm
<b>Cable Length</b>	2000mm
<b>Control</b>	On/Off Switch
<b>Light source</b>	1 x E27 LED 7W (53W Max) 806lm 2700K Complimentary Bulbs Included *



Item Code	Description	Weight
T02-F21-00BB	Black Frame, Black Reflector	2.30kg
T02-F21-00BW	Black Frame, White Reflector	2.30kg
T02-F21-00BR	Black Frame, Red Reflector	2.30kg
T02-F21-00BY	Black Frame, Yellow Reflector	2.30kg
T02-F21-01BY	Mondrian Frame, Yellow Reflector	2.30kg
T02-F21-001B	Brass Frame, Black Reflector	1.80kg
T02-F21-001W	Brass Frame, White Reflector	1.80kg

## VV Cinquanta / Suspension

Vittoriano Viganò, 1951/2016

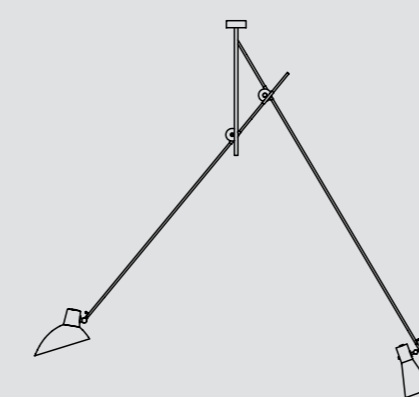

<b>Typology</b>	Suspension
<b>Materials</b>	Spun Aluminium Reflectors, Steel Structure
<b>Dimensions</b>	W250 x D1900 x H1800mm approx.
<b>Reflector diameter</b>	ø 274mm
<b>Rec. Ceiling Height</b>	330cm
<b>Weight</b>	3.00kg
<b>Control</b>	On/Off Switch
<b>Light source</b>	2 x E27 LED 7W (53W Max) 806lm (1612lm Total) 2700K Complimentary Bulbs Included *



Item Code	Description
T02-S21-00BB	Black Structure, Black Reflectors
T02-S21-00WB	Black Structure, White and Black Reflectors
T02-S21-00BR	Black Structure, Black and Red Reflectors
T02-S21-01LY	Mondrian Structure, Blue and Yellow Reflectors

## Model 237/1

Gino Sarfatti, 1959/2018

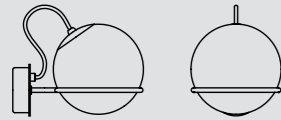

<b>Typology</b>	Wall
<b>Materials</b>	Opaline or Transparent Glass Diffuser, Steel Structure
<b>Dimensions</b>	W140 x D203 x H150mm
<b>Diffuser diameter</b>	ø 140mm
<b>Control</b>	Available with On/Off Switch
<b>Light source</b>	1 x E14 LED 4.5W (60W Max) 470lm 2700K Complimentary Bulb Included *



Item Code	Description	Weight
T08-W31-S1B0	1 Opaline Sphere, Black Mount	0.85kg
T08-W31-S1BT	1 Transparent Sphere, Black Mount	0.85kg
T08-W31-S1D0	1 Opaline Sphere, Champagne Mount	0.85kg
T08-W3S-S1B0	1 Opaline Sphere, Black Mount with Switch	1.02kg
T08-W3S-S1D0	1 Opaline Sphere, Champagne Mount with Switch	1.02kg

## Model 237/2

Gino Sarfatti, 1959/2018

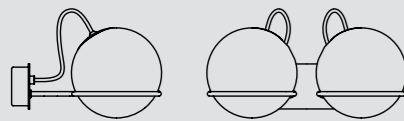

<b>Typology</b>	Wall
<b>Materials</b>	Opaline or Transparent Glass Diffuser, Steel Structure
<b>Dimensions</b>	W310 x D230 x H150mm
<b>Diffuser diameter</b>	ø 140mm
<b>Weight</b>	1.60kg
<b>Light source</b>	2 x E14 LED 4.5W (60W Max) 470lm (940lm Total) 2700K Complimentary Bulbs Included *



Item Code	Description
T08-W31-S2B0	2 Opaline Spheres, Black Mount
T08-W31-S2BT	2 Transparent Spheres, Black Mount
T08-W31-S2D0	2 Opaline Spheres, Champagne Mount

## Model 238/1

Gino Sarfatti, 1959/2018

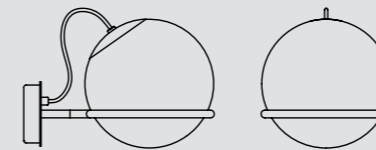

<b>Typology</b>	Wall
<b>Materials</b>	Opaline or Transparent Glass Diffuser, Steel Structure
<b>Dimensions</b>	W200 x D300 x H210mm
<b>Diffuser diameter</b>	ø 200mm
<b>Control</b>	Available with On/Off Switch
<b>Light source</b>	1 x E27 LED 7W (60W Max) 806lm 2700K Complimentary Bulb Included *



Item Code	Description	Weight
T08-W21-M1B0	1 Opaline Sphere, Black Mount	1.55kg
T08-W21-M1BT	1 Transparent Sphere, Black Mount	1.55kg
T08-W21-M1D0	1 Opaline Sphere, Champagne Mount	1.55kg
T08-W2S-M1B0	1 Opaline Sphere, Black Mount with Switch	1.75kg
T08-W2S-M1D0	1 Opaline Sphere, Champagne Mount with Switch	1.75kg

## Model 238/2

Gino Sarfatti, 1959/2018



<b>Typology</b>	Wall
<b>Materials</b>	Opaline or Transparent Glass Diffuser, Steel Structure
<b>Dimensions</b>	W450 x D320 x H210mm
<b>Diffuser diameter</b>	ø 200mm
<b>Weight</b>	3.00kg
<b>Light source</b>	2 x E27 LED 7W (60W Max) 806lm (1612lm Total) 2700K Complimentary Bulbs Included *



Item Code	Description
T08-W21-M2B0	2 Opaline Spheres, Black Mount
T08-W21-M2BT	2 Transparent Spheres, Black Mount
T08-W21-M2D0	2 Opaline Spheres, Champagne Mount

## Model 2109/12/14

Gino Sarfatti, 1959/2021

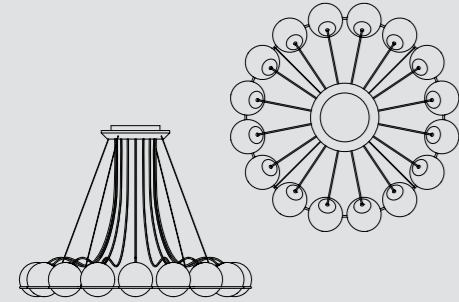

<b>Typology</b>	Suspension
<b>Materials</b>	Opaline or Transparent Glass Diffuser, Steel Structure
<b>Dimensions</b>	ø 740
<b>Diffuser diameter</b>	ø 140mm
<b>Installed Height</b>	700-1600mm
<b>Weight</b>	11.40kg
<b>Cable Length</b>	1800mm
<b>Light source</b>	12 x E14 4.5W (60W Max) 470lm (5640lm Total) 2700K Complimentary Bulbs Included *



Item Code	Description
T08-S31-SCBO	12 Opaline Spheres, Black Structure
T08-S31-SCBT	12 Transparent Spheres, Black Structure
T08-S31-SCDO	12 Opaline Spheres, Champagne Structure

## Model 2109/24/14

Gino Sarfatti, 1959/2018

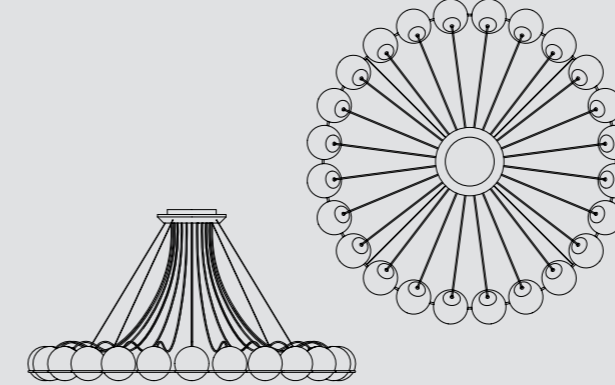

<b>Typology</b>	Suspension
<b>Materials</b>	Opaline or Transparent Glass Diffuser, Steel Structure
<b>Dimensions</b>	ø 1340
<b>Diffuser diameter</b>	ø 140mm
<b>Installed Height</b>	700-1600mm
<b>Weight</b>	21.20kg
<b>Cable Length</b>	1800mm
<b>Light source</b>	24 x E14 LED 4.5 W (60W Max) 470lm (11280lm Total) 2700K Complimentary Bulbs Included *



Item Code	Description
T08-S31-SOBO	24 Opaline Sphere, Black Structure
T08-S31-SOBT	24 Transparent Spheres, Black Structure
T08-S31-SODO	24 Opaline Spheres, Champagne Structure

## Model 2109/16/14

Gino Sarfatti, 1959/2018

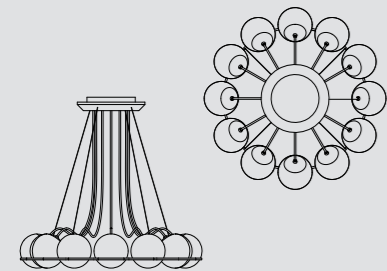

<b>Typology</b>	Suspension
<b>Materials</b>	Opaline or Transparent Glass Diffuser, Steel Structure
<b>Dimensions</b>	ø 950
<b>Diffuser diameter</b>	ø 140mm
<b>Installed Height</b>	700-1800mm
<b>Weight</b>	14.80kg
<b>Cable Length</b>	1800mm
<b>Light source</b>	16 x E14 LED 4.5W (60W Max) 470lm (7520lm Total) 2700K Complimentary Bulbs Included *



Item Code	Description
T08-S31-SGBO	16 Opaline Spheres, Black Structure
T08-S31-SGBT	16 Transparent Spheres, Black Structure
T08-S31-SGDO	16 Opaline Spheres, Champagne Structure

## Model 2109/16/20

Gino Sarfatti, 1959/2018

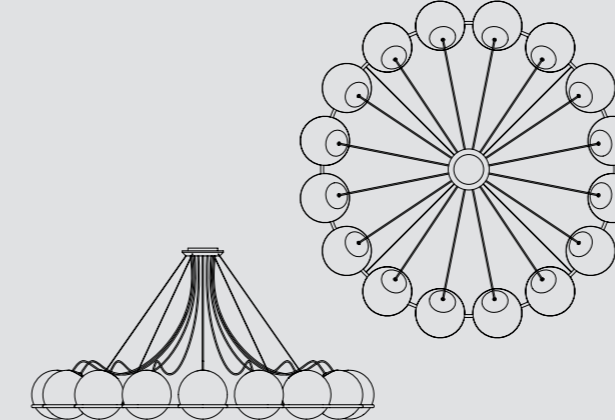

<b>Typology</b>	Suspension
<b>Materials</b>	Opaline or Transparent Glass Diffuser, Steel Structure
<b>Dimensions</b>	ø 1400
<b>Diffuser diameter</b>	ø 200mm
<b>Installed Height</b>	700-1600mm
<b>Weight</b>	26.20kg
<b>Cable Length</b>	1800mm
<b>Light source</b>	16 x E27 LED 7W (60W Max) 806lm (12896lm Total) 2700K Complimentary Bulbs Included *



Item Code	Description
T08-S21-MGB0	16 Opaline Spheres, Black Structure
T08-S21-MGBT	16 Transparent Spheres, Black Structure
T08-S21-MGDO	16 Opaline Spheres, Champagne Structure

## Model 2042/3

Gino Sarfatti, 1963/2020

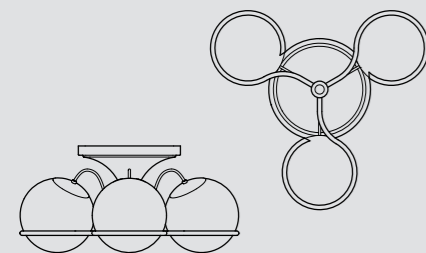

<b>Typology</b>	Ceiling
<b>Materials</b>	Opaline or Transparent Glass Diffuser, Steel Structure
<b>Dimensions</b>	ø 650 x H290mm
<b>Diffuser Diameter</b>	ø 200mm
<b>Light source</b>	3 x E27 LED 7W (60W Max) 806lm (2418lm Total) 2700K Complimentary Bulbs Included *



Item Code	Description
T08-C21-M6B0	6 Opaline Spheres, Black Mount
T08-C21-M6BT	6 Transparent Spheres, Black Mount
T08-C21-M3D0	3 Opaline Spheres, Champagne Mount

## Model 2042/9

Gino Sarfatti, 1963/2019

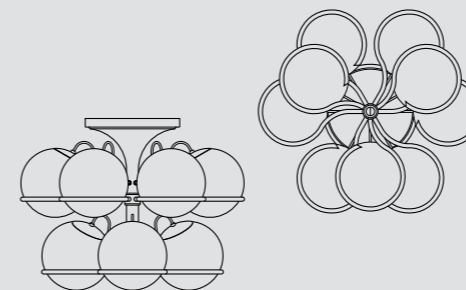

<b>Typology</b>	Ceiling
<b>Materials</b>	Opaline or Transparent Glass Diffuser, Steel Structure
<b>Dimensions</b>	ø 650 x H500mm
<b>Diffuser diameter</b>	ø 200mm
<b>Light source</b>	9 x E27 LED 7W (60W Max) 806lm (7254lm Total) 2700K Complimentary Bulbs Included *



Item Code	Description
T08-C21-M9B0	9 Opaline Spheres, Black Mount
T08-C21-M9BT	9 Transparent Spheres, Black Mount
T08-C21-M9D0	9 Opaline Spheres, Champagne Mount

## Model 2042/6

Gino Sarfatti, 1959/2019

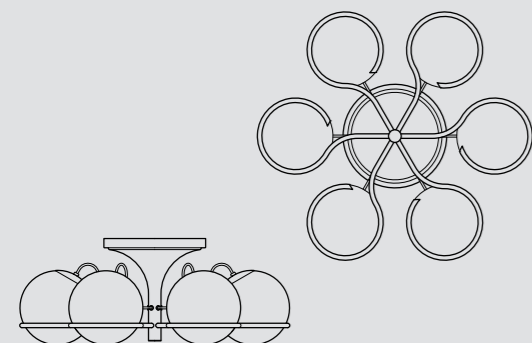

<b>Typology</b>	Ceiling
<b>Materials</b>	Opaline or Transparent Glass Diffuser, Steel Structure
<b>Dimensions</b>	ø 650 x H290mm
<b>Diffuser diameter</b>	ø 200mm
<b>Weight</b>	9.40kg
<b>Light source</b>	6 x E27 LED 6W 806lm (4836lm Total) 2700K Complimentary Bulbs Included *



Item Code	Description
T08-C21-M6B0	6 Opaline Spheres, Black Mount
T08-C21-M6BT	6 Transparent Spheres, Black Mount
T08-C21-M6D0	6 Opaline Spheres, Champagne Mount

## Model 1081

Gino Sarfatti, 1963/2019



<b>Typology</b>	Floor
<b>Materials</b>	Opaline Glass Diffuser, Steel Structure
<b>Dimensions</b>	200 x 1680-1820mm
<b>Diffuser diameter</b>	ø 200mm
<b>Control</b>	Foot Dimmer
<b>Light source</b>	9 x E27 LED 7W (60W Max) 806lm 2700K Complimentary Bulbs Included *



Item Code	Description	Height	Weight
T08-F21-100B	Opaline Sphere, Black Structure	1680mm	7.90kg
T08-F21-200B	Opaline Sphere, Black Structure	1820mm	8.00kg

## Model 2065

Gino Sarfatti, 1950/2016



<b>Typology</b>	Suspension
<b>Materials</b>	Opaline Methacrylate Diffusers, Aluminium Hardware
<b>Dimensions</b>	ø 538 x 546mm
<b>Diffuser diameter</b>	ø 538mm
<b>Weight</b>	2.70kg
<b>Cable Length</b>	3000mm
<b>Light source</b>	5 x E14 LED 4.5W (12W Max) 470lm (2350lm Total) 2700K Complimentary Bulbs Included *



Item Code	Description
T01-S31-0BBW	Black & White Diffuser, Black Hardware, Black Cable
T01-S31-0BWW	White Diffuser, Black Hardware, Black Cable
T01-S31-0WWW	White Diffuser, Black Hardware, White Cable

## Model 537

Gino Sarfatti, 1950/2019

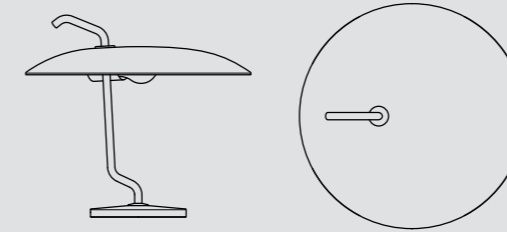

<b>Typology</b>	Table
<b>Materials</b>	Spun Aluminium reflector, Brass Structure, Marble Base
<b>Dimensions</b>	ø 400 x H360mm
<b>Reflector diameter</b>	ø 400mm
<b>Weight</b>	2.45kg
<b>Control</b>	On/Off Switch
<b>Light source</b>	1 x E27 LED 4.5W (60W Max) Complimentary Bulb Included *



Item Code	Description
T09-T21-001B	Brass Structure, Black Reflector, White Marble Base
T09-T21-001W	Brass Structure, White Reflector, White Marble Base
T09-T21-00BB	Black Structure, Black Reflector, Black Marble Base

## Model 2065 Wall

Gino Sarfatti, 1955/2021

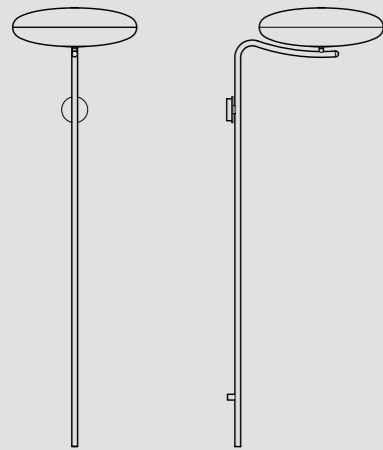

<b>Typology</b>	Wall
<b>Materials</b>	Opaline Methacrylate Diffusers, Steel Structure
<b>Dimensions</b>	W538 x D680 x H1900mm
<b>Diffuser diameter</b>	ø 538mm
<b>Light source</b>	5 x E14 LED 4.5W (12W Max) 470lm (2350lm Total) 2700K Complimentary Bulbs Included *



Item Code	Description	Weight	Cable Length
T01-W31-0BWW	White Diffuser, Black Structure	5.10kg	2400mm
T01-W31-POWW	White Diffuser, Black Structure with plug	5.30kg	2400mm

## Model 548

Gino Sarfatti, 1951/2013

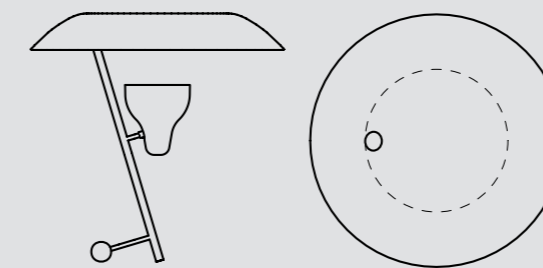

<b>Typology</b>	Table
<b>Materials</b>	Brass Structure, Opaline Methacrylate Diffuser
<b>Dimensions</b>	ø 500 x 500mm
<b>Diffuser diameter</b>	ø 500mm
<b>Weight</b>	3.10kg
<b>Control</b>	Touch Dimmer
<b>Light source</b>	Integrated LED 11W 730lm 2700K



Item Code	Description
T03-T12-00BG	Dark Burnished Brass with Grey Diffuser
T03-T12-00BO	Dark Burnished Brass with Orange Diffuser
T03-T12-00BY	Dark Burnished Brass with Yellow Diffuser
T03-T12-001A	Polished Brass with Azure Diffuser
T03-T12-001G	Polished Brass with Grey Diffuser

## Model 566

Gino Sarfatti, 1956/2020

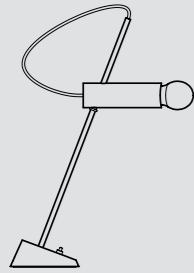

<b>Typology</b>	Table
<b>Materials</b>	Aluminum Body, Steel Stand, Cast Alloy Base
<b>Dimensions</b>	W140 x D374 x H506mm
<b>Cable length</b>	1500mm
<b>Weight</b>	2.10kg
<b>Control</b>	On/Off Switch
<b>Light source</b>	1 x B22 LED 8W (8W Max) 700lm 2700K Complimentary Bulb Included *



Item Code	Description
TII-T41-000B	Black
TII-T41-000G	Polished

## Model 1095

Gino Sarfatti, 1968/2023

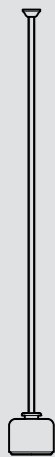

<b>Typology</b>	Floor
<b>Materials</b>	Aluminium Stem, Spun Steel Base
<b>Dimensions</b>	ø 200 x 1700-2000mm
<b>Reflector Diameter</b>	ø 80mm
<b>Control</b>	Foot Dimmer
<b>Light source</b>	Integrated LED 2700K



Item Code	Description	Height	Weight
T06-F12-210B	1700mm Height, Black Stem, White Base	1700mm	6.20kg
T06-F12-220B	1850mm Height, Black Stem, White Base	1850mm	6.30kg
T06-F12-230B	2000mm Height, Black Stem, White Base	2000mm	6.50kg

\* The bulbs included in our products are offered on a complimentary basis, as a service that Astep provides. Due to the complexity of electrical systems, we cannot guarantee that bulbs will function in all scenarios. We cannot guarantee that bulbs included with our products are compatible with all lighting systems.



Astep is a lighting company built on design, innovation and sustainability carefully balancing purpose and profits. With an eye firmly focused on minimizing its impact on the environment and on caring for its stakeholders, Astep brings back to life timeless, revolutionary lamps of the past while envisaging new classics of today.

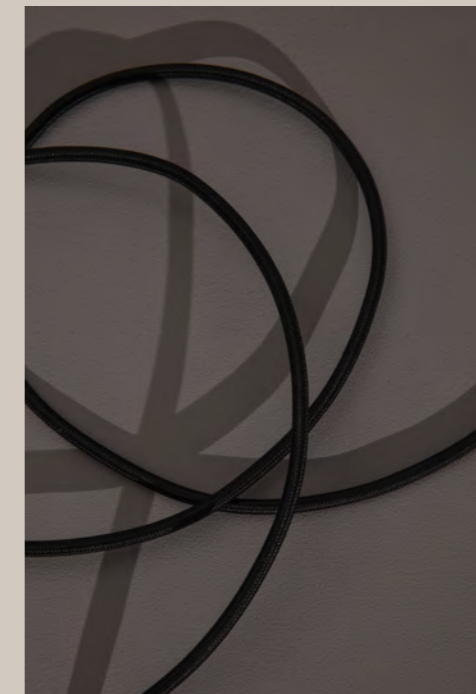

Astep ApS  
Esplanaden 6  
1263 Copenhagen  
Denmark  
  
+45 70 70 50 01  
  
www.astep.design

Astep reserves the right to introduce any changes  
to its own models without prior notice

For sales inquiries please contact sales@astep.design

Copyright Astep 2023

Photography Heidi Lerkenfeldt  
  
Ditlev Rosing (p. 2, 26, 58, 66, 72, 84, 88, 109, 115)  
Hasse Nielsen (p. 4)  
Mikkel Vigholt (p. 22, 26, 102)  
Sistema Manifesto (p. 24, 25)  
Alistair Philip Wiper (p. 87, 99)  
Jonas Bjerre-Poulsen (p. 108, 114)

Styling Pernille Vest  
  
Sofie Brünner (p. 108, 114)

Project Director Yasmin Edgecombe

Graphic Design Sigrid Gry Laursen

#### Special Thanks

Af Jord, Aytm, Anna C. N. Meyer, Anne Brandhøj, Anne Bystrup, Birute Si, C/RO  
Copenhagen, Carl Hansen & Søn, Chandler Mclellan, Daniel Westers, Doriana  
De Petris, Birgitte Due Madsen, FDB Møbler, Fjord Interior, Fora Projects, Frama,  
Hanne Lereim, Henrik Glahn, Jonas Trampedach, Josefine Winding, Karakter,  
Karen Bennicke, Katrine Blinkenberg, Kia Handler, Kirsten Schrøder, Kusiner  
Carpets, Layered, Lerkenfeldt Gallery, Linnea Ek Blæhr, Lone Grønder, Louise  
Roe, Massproductions, Maria Enæs, Menu, Vang Stensgaard, Montana, Munk  
Collective, New Works, Niels Hvass, Objekte unserer tage, Ole Mynster Herold,  
Patrizia Cassina, Paustian, Pierre Chapo, Project 213a, Robynn Storgaard, Room  
by Sarah, Rue Verte, Sacre Coeur, Salvatori, Society Limonta, Stine Mikkelsen,  
Stine Regild, Studio 0405, Søren Jacobsen, Thonet, The Posterclub, Thomas  
Granslev, Thora Finnsdóttir, Tine K Home, Viki Weiland, Wabi Sabi Nordic.

# Timeless

# Inventions

## **Collection**

Gino Sarfatti

Vittoriano Viganò

Carlo Santi

Vittorio Borachia

Franco Albini

Franca Helg

Oswaldo Borsani

Alfredo Häberli

Francisco Gomez Paz

Francesco Faccin

David Thulstrup

**astep®**