



book 2017



caccaro

Ascoltiamo

**le esigenze
e le passioni.**

We listen

***to needs
and passions.***

Cerchiamo

We seek

l'intuizione

the intuition

**che costruisce
un dialogo positivo con
la casa e le persone.**

***to build up
a positive dialogue with
homes and people.***

Rispondiamo

**con soluzioni concrete
per l'oggi e il domani**

aperte

**all'espressione
personale.**

We answer

***with concrete solutions
for today and tomorrow***

all open

***to personal
expression.***

Uno spazio pieno di risposte.
A space full of answers.

Ogni casa è composta da spazi diversi, in relazione fluida l'uno con l'altro e spesso commisti. Caccaro interpreta le nuove esigenze dell'abitare, lasciando piena libertà di interpretare i prodotti rispetto alla loro destinazione d'uso: dalla zona giorno, alla zona notte, con versatilità nell'utilizzo e continuità nello spazio.

Every home is made up of different spaces, in fluid relationship with one another and often mixed together. Caccaro interprets new living requirements by allowing total freedom in interpreting the products with respect to their intended use: from the day area to the night area, with versatility of use and space continuity.

day

night



roomy living



brick multimedia

brick

side, sideview
• news 2017 p.12



groove+side
• news 2017 p.12, 40



lineare

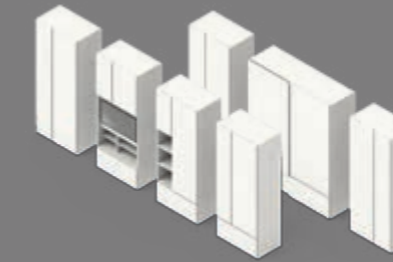

grafik

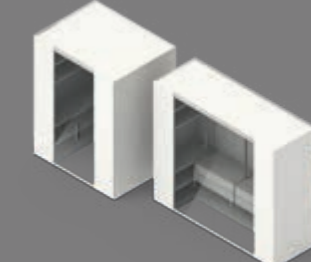

camerino



flat

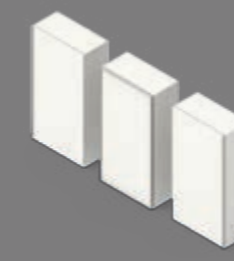

loom

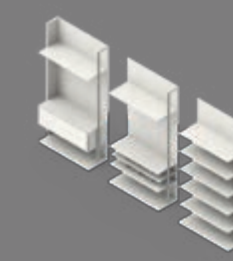

cabina

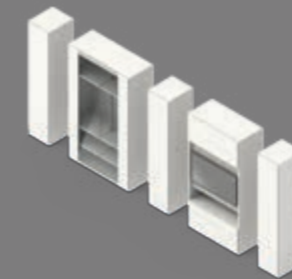

roomy night



view, side
• news 2017 p.12

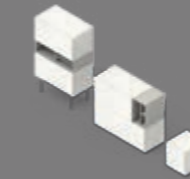

brick



filnox



fill



fildress



filbook



groove
• news 2017 p.40



tune
• news 2017 p.56



bag
• news 2017 p.56



opus



pliè

armadi e cabine
wardrobes and walk-in-cabinets

sistemi abitativi
furnishing system

contenitori
storage units

letti
beds

12

Suddividere, mantenendo la continuità.
Dividing up, maintaining continuity.

side, sideview, view



40

Interpretare lo spazio con un pensiero versatile.
Interpreting space with a versatile thought.

groove

56

Scegliere la giusta sintonia.
Choosing the perfect sync.

tune, bag

side, sideview, view
design Monica Graffeo

Suddividere, mantenendo la continuità.
Dividing up, maintaining continuity.

side madia con piedistallo 202x48xh72 cm, noce e laccato nero stout /
sideboard with pedestal cm 202x48xh72, walnut and nero stout
lacquered sideview madia con separè 170x54xh203 cm, laccato
opaco sabbia e nero stout, telo screen grigio pietra / sideboard with
partition cm 170x54xh203, sabbia matt lacquered and nero stout,
grigio pietra screen fabric



side, sideview, view

13





questa pagina e pagina precedente *this page and previous page*
sideview madia con separè 170x54xh203 cm, laccato opaco sabbia e nero stout, telo screen grigio antracite / *sideboard with partition cm 170x54xh203, sabbia matt lacquered and nero stout, grigio antracite screen fabric*

a destra *on the right*
view separè con accessori ingresso 100 cm, altezza max 305 cm realizzato a misura da pavimento a soffitto, laccato opaco nero stout, telo screen grigio antracite / *partition with cm 100 entrance accessories, max height cm 305 made to measure from floor to ceiling, nero stout matt lacquered, grigio antracite screen fabric*

Suddividere, mantenendo la continuità.

Come una quinta teatrale o una tenda, **view** può separare e creare privacy, lasciando filtrare dolcemente la luce e facendo intravedere gli spazi e le cose. Le linee arrotondate dei contenitori **side**, sono accoglienti, amichevoli e permettono inaspettati abbinamenti e situazioni. **sideview** unisce le funzioni di madia e separè in un unico elemento. Un progetto completo che si veste di tessuti e colori diversi, interpretando molteplici ruoli.

Dividing up, maintaining continuity.

Like a theatre or home curtain, **view** can separate and create privacy, allowing the light to gently filter through and making it possible to see spaces and things. The rounded lines of the side storage units are appealing, friendly and permit unexpected matches and situations. **sideview** combines the functions of a sideboard and a partition in a single element. A complete project dressed in different fabrics and colours, which interprets numerous different roles.

intuizione *intuition*

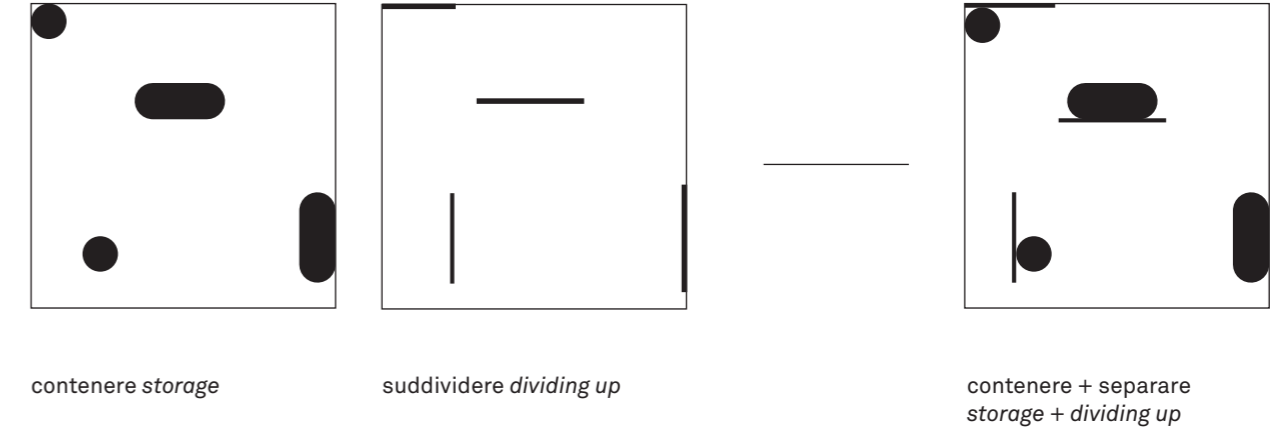

logica di collezione *collection logic*

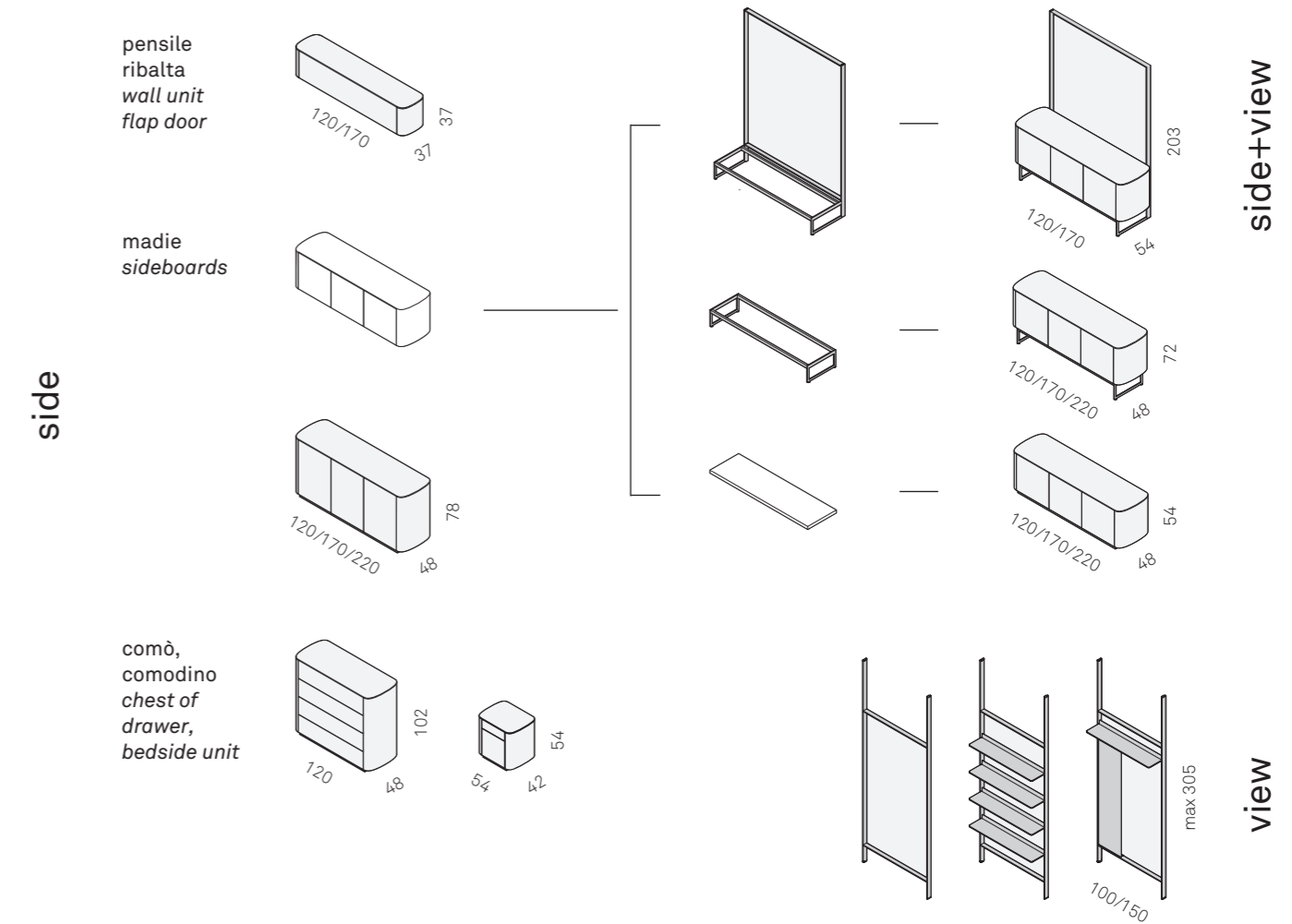

cucina+living
kitchen+living area

Negli open space, piccoli o grandi che siano, le separazioni fisiche fra gli ambienti vengono annullate, ma le diverse funzioni rimangono. **sideview** si inserisce in questo concetto di casa, rispettandone lo spirito e soddisfacendo le sue esigenze.

*In open-plan areas, whether small or large, physical partitions between environments are eliminated, but the different functions remain. **sideview** belongs to this home concept, in tune with its spirit and satisfying its requirements.*

01

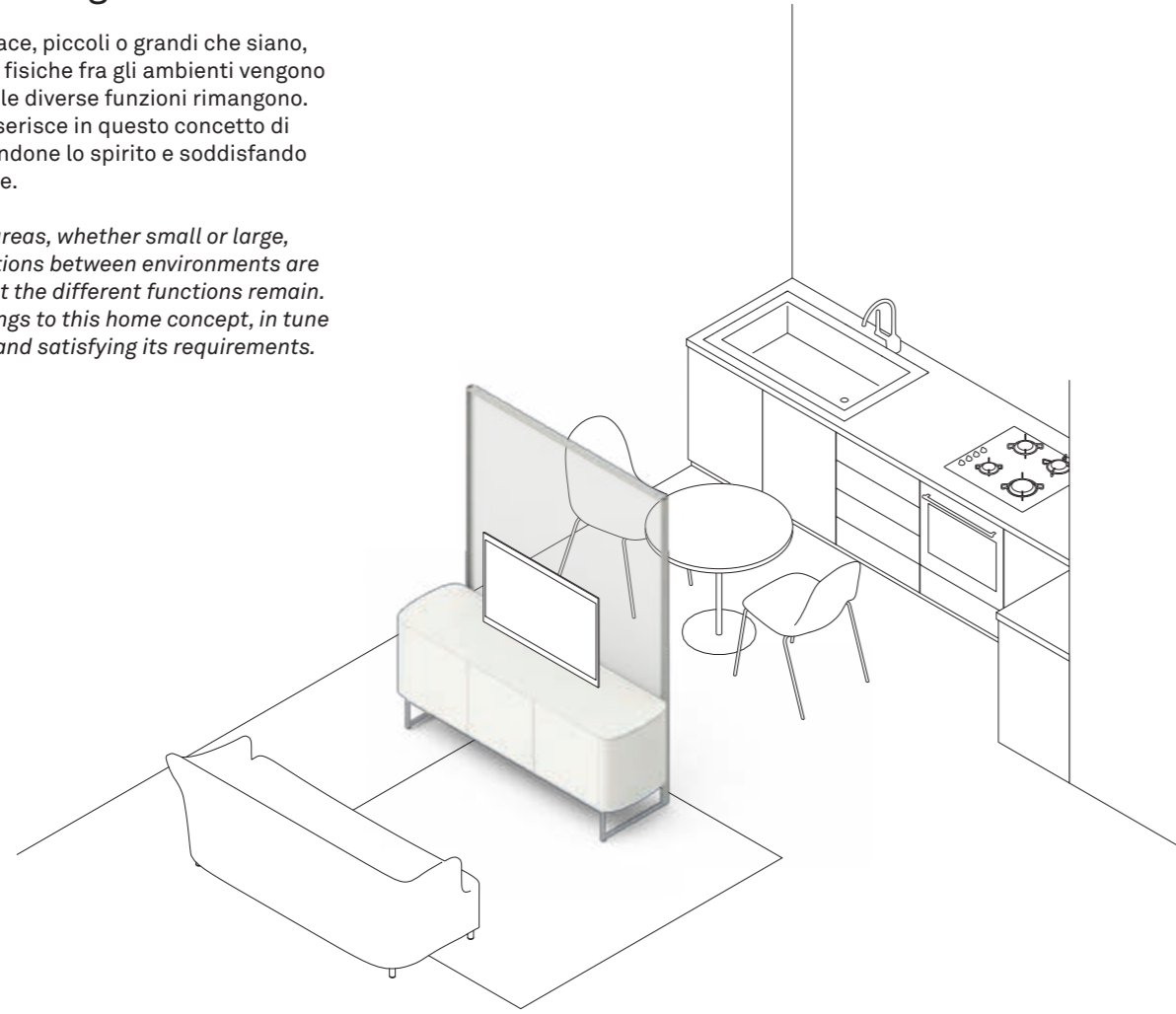

02

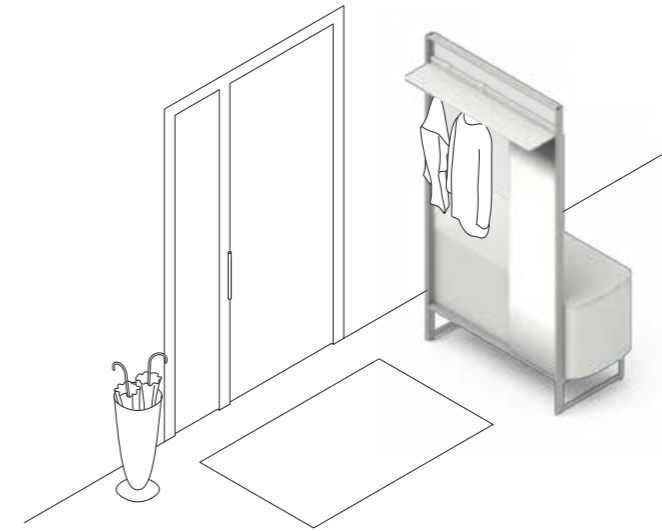

ingresso *entrance*

sideview può creare un accenno di separazione nella zona ingresso, offrendo delle utili funzioni, con leggerezza visiva.

***sideview** can create an idea of partition in the entrance area, providing useful functions and a lightness of vision.*

notte+studio
night+study

Una possibilità interessante è creare con **view** una zona studio, collocata in una situazione notte oppure in un ambiente living, senza creare una situazione di isolamento fra gli spazi.

***view** provides an interesting opportunity to create a study area within a night area or in a living environment, without generating a situation of isolation between spaces.*

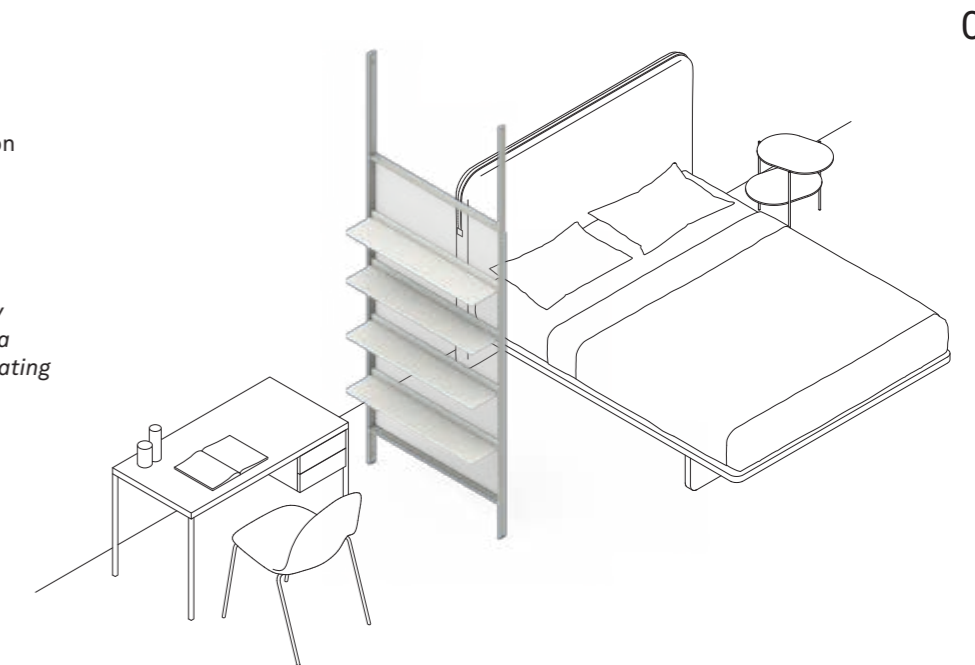

03



sideview madia con separè e accessori ingresso 170x54xh203 cm,
noce e laccato opaco nero stout, telo screen grigio pietra / sideboard
with partition and entrance accessories cm 170x54xh203, walnut and
nero stout matt lacquered, grigio pietra screen fabric





Dettagli che fanno la differenza: le linee morbide della collezione **side**, la struttura in alluminio della base e del separè **view** / *details that make the difference: the soft lines of the **side** collection, the aluminium structure of the base and of the **view** partition*



side pensile 170x37xh37 cm, laccato opaco bianconeve /
cm 170x37xh37 wall unit, bianconeve matt lacquered **groove** barra
pensile 183 cm con illuminazione e appendini, laccato opaco rugiada /
cm 183 wall bar with lighting and hangers, rugiada matt lacquered



side pensile, l'anta si apre a ribalta e svela un capiente spazio dedicato al contenimento / *wall unit, the door features flap opening reveals a spacious storage compartment*



side madia con piedistallo 202x48xh72 cm, laccato opaco cenere e nero stout / sideboard with pedestal cm 202x48xh72, *cenere and nero stout matt lacquered*



side madia 202x48xh54 cm in noce e laccato opaco nero stout / cm 202x48xh54 *sideboard in walnut and nero stout matt lacquered*



side madia 170x48xh78 cm, laccato opaco rugiada / cm 170x48xh78 *sideboard, rugiada matt lacquered*



L'interno delle madie *side* è dotato di un ripiano in cristallo di forma asimmetrica, per consentire l'alloggio di oggetti anche di altezza maggiore rispetto a quella dei vani interni / *the inside of the side sideboards features an asymmetric-shaped glass shelf, for housing even taller objects than in the inside compartments*





side comò 120x48xh102 cm e comodino 54x42xh54 cm noce / walnut
chest of drawer cm 120x48xh102 and cm 54x42xh54 bedside unit

side comò 120x48xh102 cm e comodino 54x42xh54 cm laccato opaco
cenero / cenero matt lacquered chest of drawer cm 120x42xh54
and cm 54x24xh54 bedside unit



side madia con piedistallo 202×48×h72 cm, noce e laccato opaco nero stout / *sideboard with pedestal cm 202×48×h72, walnut and nero stout matt lacquered*

Linee essenziali e avvolgenti, creano una sensazione di naturale armonia / *essential and wrap-around lines create a feeling of natural harmony*





view è proposto nella variante con specchio, mensola e appendiabiti, ideale per un ingresso, oppure con mensole, utilizzabile come libreria, o in versione separé semplice, laccato opaco nero stout e telo screen disponibile nei colori grigio antracite e grigio perla / it is available in version with mirror, shelf and clothes hanger, ideal for an entrance, or with shelves, usable as a bookcase, or in simple partition version, nero stout matt lacquered and screen fabric available in grigio antracite and grigio perla colours

Interpretare lo spazio con un pensiero versatile.
Interpreting space with a versatile thought.

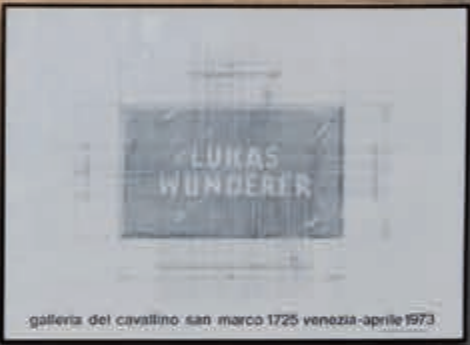

groove barra 183 cm con luce led superiore e inferiore, laccato opaco
rugiada / *cm 183 bar with top and bottom LED light, rugiada matt*
lacquered brick panca laccato opaco quarzo e cuscini in tessuto
step 01 / *quarzo matt lacquered bench and cushions in step 01 fabric*



groove barra pensile con luce led superiore e inferiore, laccato opaco
rugiada / wall bar with top and bottom LED light, rugiada matt lacquered



abitare living

day

01

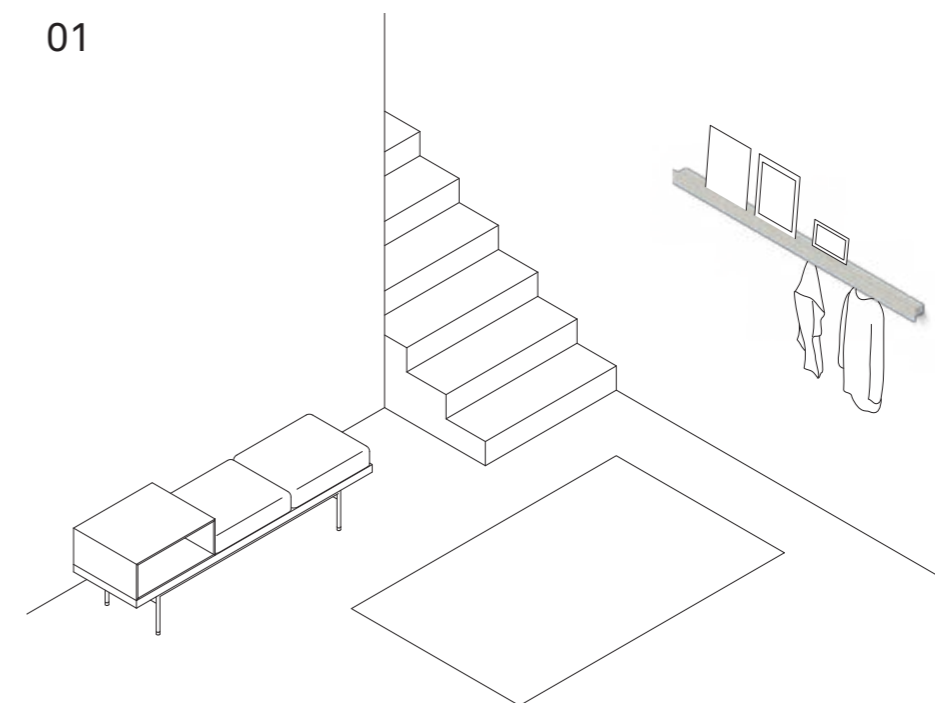

parete wall

groove trova collocazione in diversi ambiti della casa, ad esempio per decorare una parete altrimenti spoglia, o al contrario per valorizzarne le qualità materiche, con un'illuminazione radente e regolabile.

groove can be positioned in various parts of the home, e.g., to decorate an otherwise bare wall, or on the other hand to enhance the material qualities of a wall with grazing and adjustable lighting.

living living area

In soggiorno, **groove** può essere utilizzata per accompagnare la zona relax, creando un'esposizione di oggetti da collezione, foto ricordo, quadri e poster.

In the lounge, groove can be used to accompany the relaxation area, creating a display of collector's items, souvenir photos, paintings and posters.

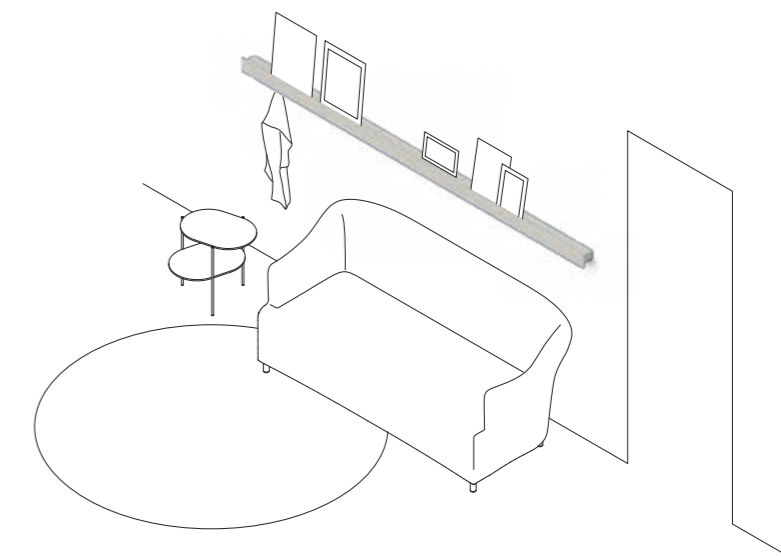

02

Interpretare lo spazio con un pensiero versatile.

groove è un'idea che riunisce più funzioni, risolvendo e personalizzando diversi ambienti della casa. Una sintesi di design e tecnologia per svolgere le normali esigenze di illuminazione, appoggio, ma anche per valorizzare una parete, creare un'atmosfera, organizzare un museo domestico di oggetti artistici, preziosi o legati alla memoria, oppure dare vita a situazioni accoglienti e inedite nello spazio notte.

Interpreting space with a versatile thought.

groove is an idea which combines several functions, fitting into and personalizing different home environments. A synthesis of design and technology to cater to normal supporting light requirements, but also to enhance a wall, create an atmosphere, organize a home museum of art or precious objects or objects tied to memories, or to give life to cosy and original situations in the night area.

logica di collezione *collection logic*

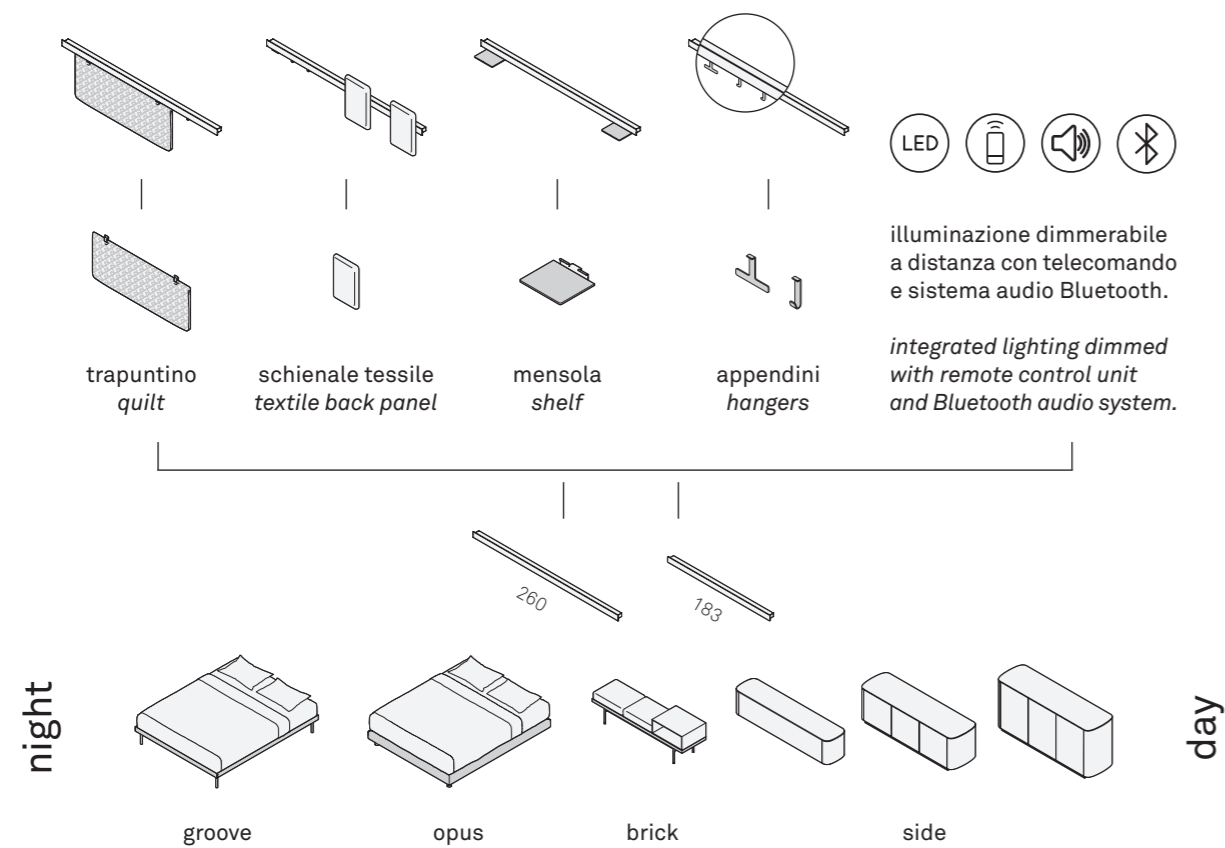

Le collezioni Caccaro prendono forma dall'osservazione delle nuove tendenze che si creano spontaneamente nell'universo dell'abitare. Anche groove nasce da una ricerca sulle immagini di ambienti domestici reali, pubblicate sul web da riviste di arredamento e design, blogger, portali di case in affitto. Questa analisi ha evidenziato un diffuso processo di destrutturazione della testiera del letto, con soluzioni più libere, originali e integrate con forme essenziali di contenimento e di illuminazione.

Caccaro collections take shape by observing new trends created spontaneously in the home living universe. groove too is the upshot of research into real home images, published on the web by furnishing and design magazines, bloggers, home rental portals. This analysis has pointed to a widespread process of bed headboard deconstructing, with freer, original and integrated solutions featuring essential storage and lighting shapes.

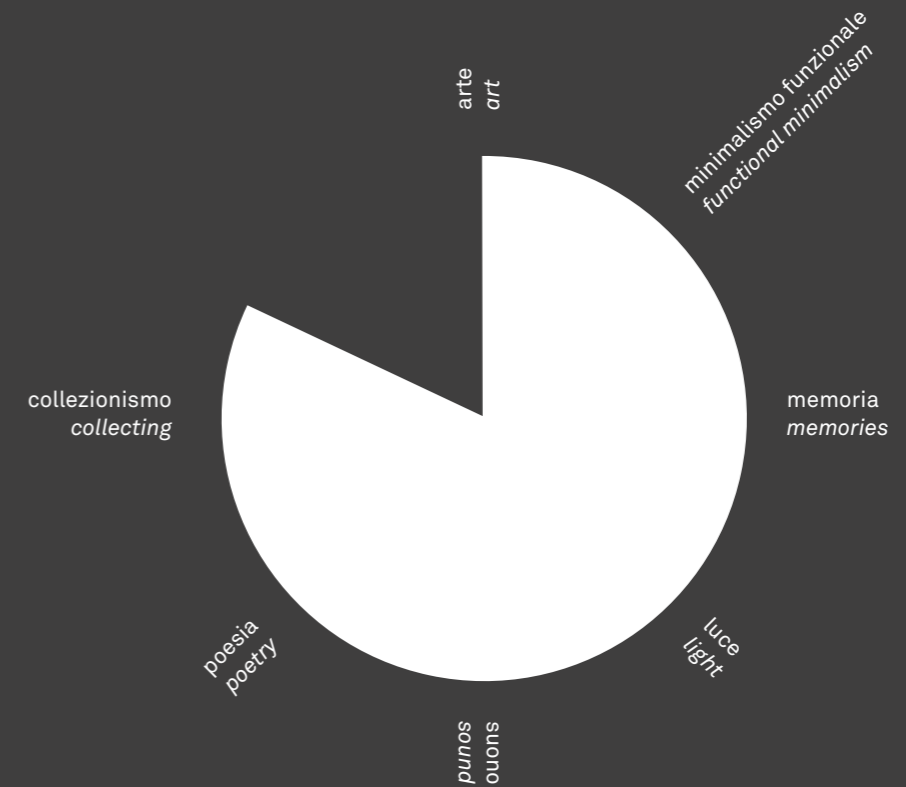

testiera destrutturata per esigenze scenografiche
headboard dismantled for scenographic purpose



contenimento minimo
ring invisible
minimum containment
invisible ring

night

groove si presta a interpretare in maniera personale e inattesa la tradizionale testiera con un elemento multifunzionale, in versione laccata o rivestita in tessuto. Il sistema di illuminazione regolabile, può creare un'atmosfera sognante oppure agevolare la lettura; la barra può essere utilizzata per appoggiare foto, quadri, libri e altri oggetti, in maniera studiata o casuale.

groove is perfect for interpreting the traditional headboard in a personal and unexpected way with a multifunctional element in lacquered or fabric upholstered version. The adjustable lighting system can create a dreamy atmosphere or make reading easier; the bar can be used to support photos, pictures, books and other objects in a studied or casual way.



illuminazione dimmerabile
a distanza con telecomando
e sistema audio Bluetooth.

*integrated lighting dimmed with
remote control unit
and Bluetooth audio system.*



03

parete *wall*

Collocabile dietro il letto all'altezza desiderata, in posizione simmetrica oppure asimmetrica, **groove** si presta ad essere utilizzato sia come mensola che come aggancio per abiti, collane e borse, grazie agli appositi accessori.

groove can be positioned behind the bed at the desired height, in symmetric or asymmetric position, and is perfect for use as a shelf or a hanger for clothes, necklaces and bags, thanks to specific accessories.

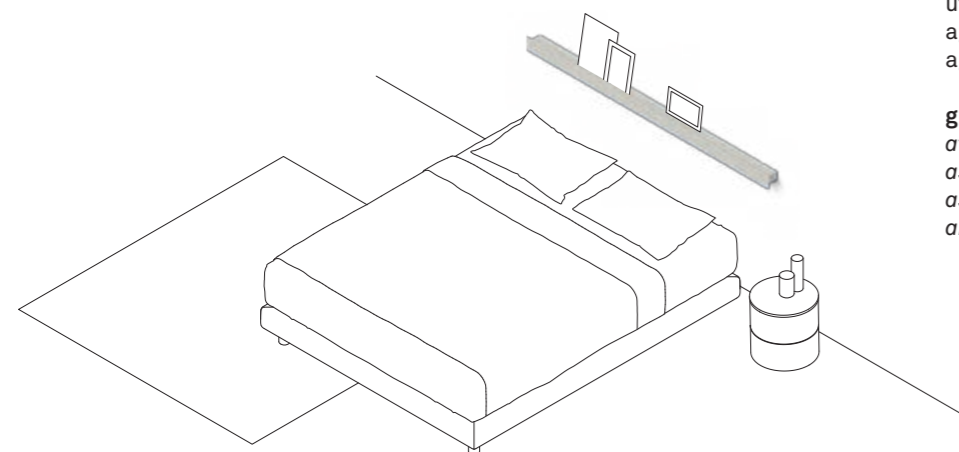

angolo *corner*

groove può rendere interessanti e funzionali spazi ristretti, posizionandosi per esempio anche di lato al letto, per offrire una comoda base d'appoggio.

groove can make confined spaces interesting and functional, by positioning itself, for example, at the side of the bed, to provide a comfortable supporting base.

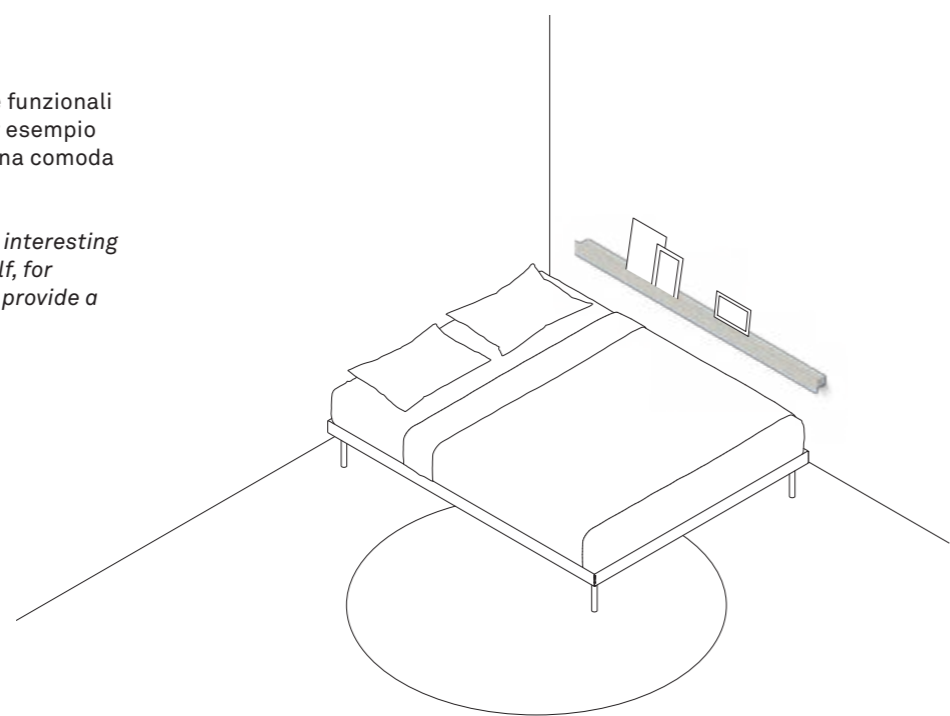

04

groove barra pensile con luce led superiore e inferiore e appendini, laccato opaco ardesia / *wall bar with top and bottom LED light and hangers, ardesia matt lacquered*



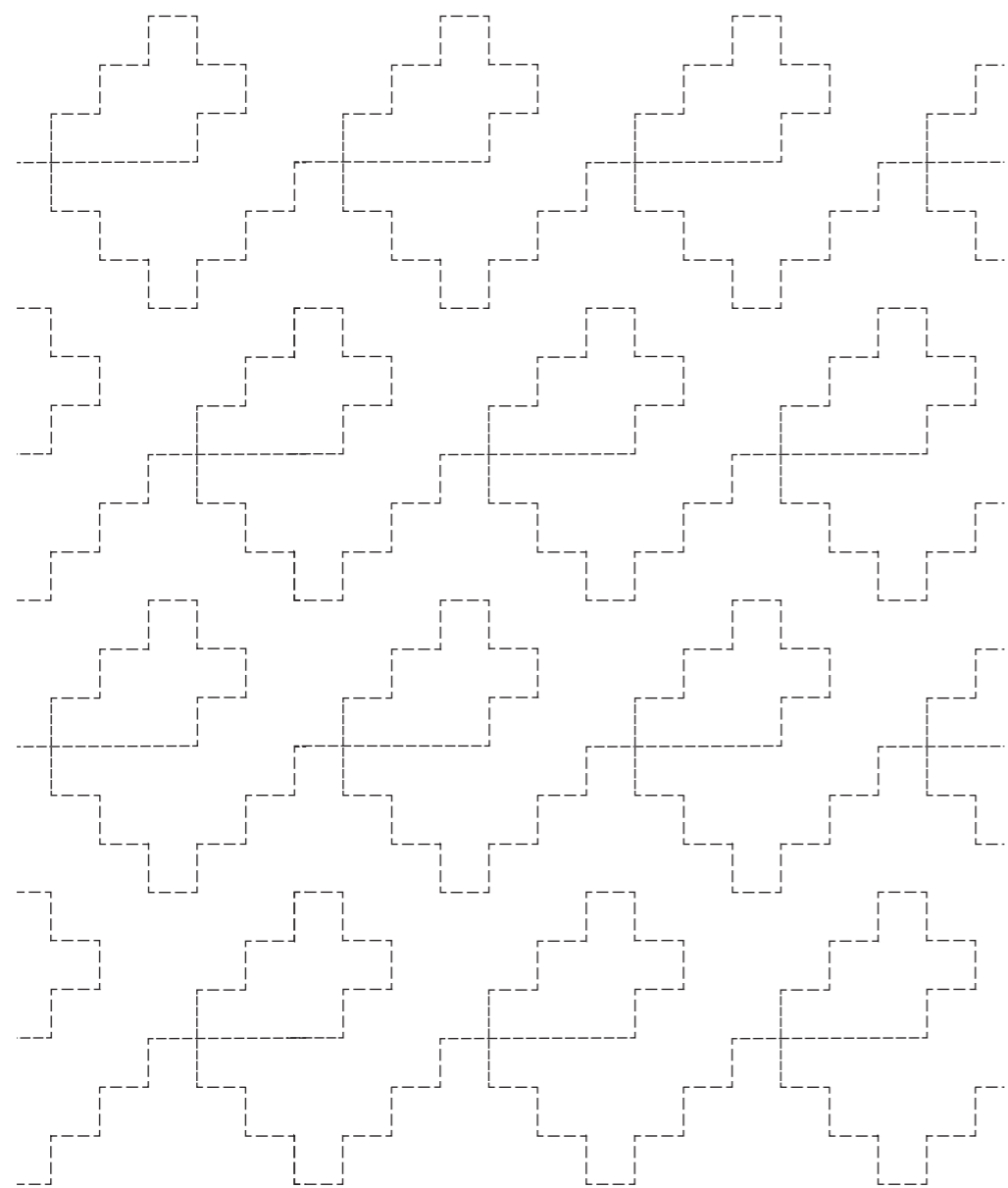

quilt

quilt è una trapunta con un affascinante disegno a impuntura, ideato in esclusiva per Caccaro traendo ispirazione dalla tradizionale tecnica giapponese Sashiko. La ripetizione del singolo tratto geometrico, crea un effetto ricco e delicato.

quilt is a fascinating quilted design, conceived exclusively for Caccaro and which takes its inspiration from the traditional Japanese Sashiko technique. The repetition of the individual geometric stroke creates a rich and delicate effect.

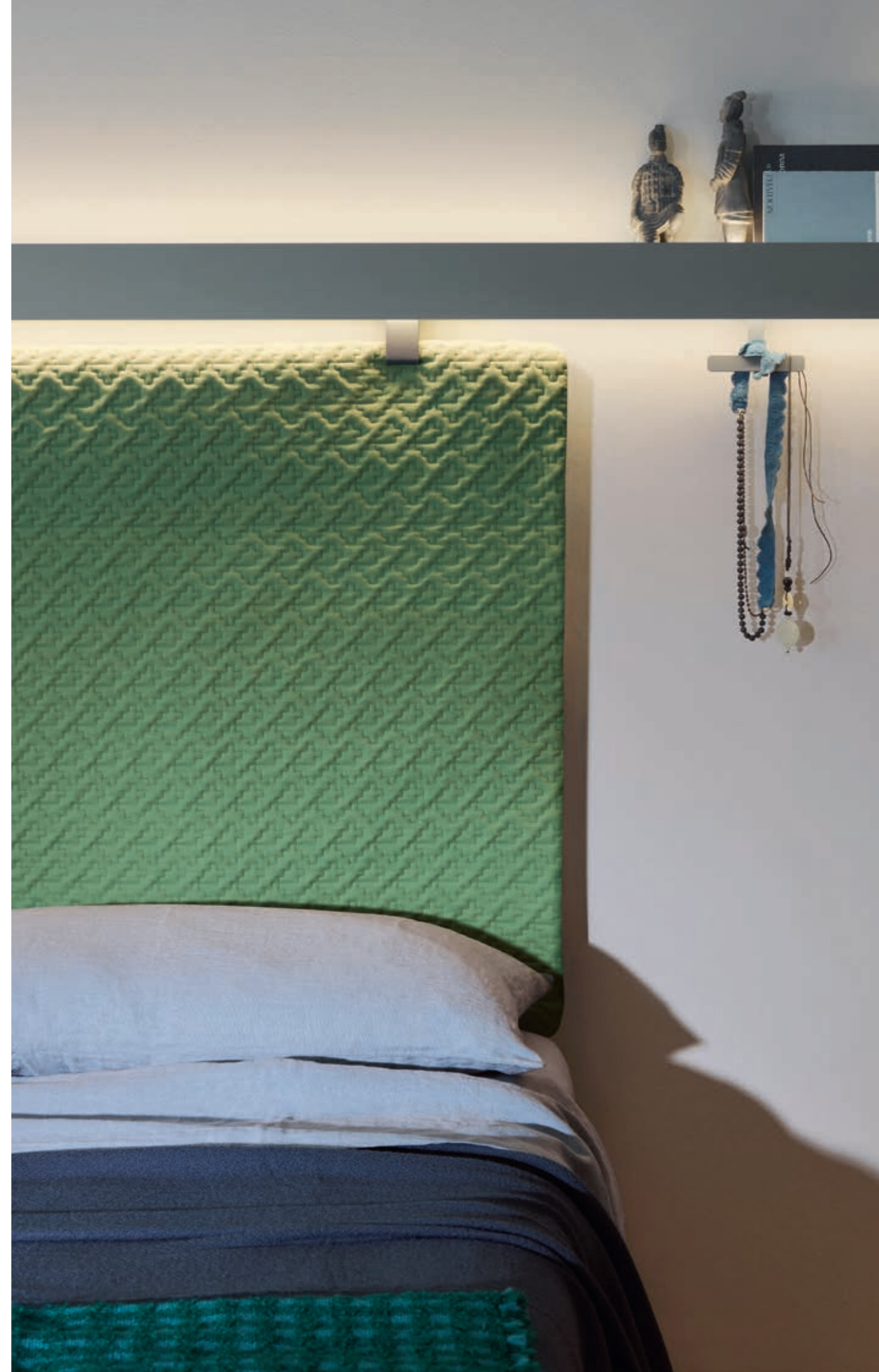

groove barra pensile 260 cm accessoriata con appendini e trapunta quilt in tessuto 03, dotata di luce led superiore ed inferiore. In abbinamento, base letto opus in tessuto step 01 / cm 260 wall bar accessorized with hangers and quilt in fabric 03, complete with top and bottom LED light. Matching opus bed base in fabric step 01



tune, bag
design Monica Graffeo

Scegliere la giusta sintonia
Choosing the perfect sync.

tune, bag



56 **tune** letto con bande elastiche, laccato opaco sabbia / *bed with elastic bands, sabbia matt lacquered*

book 2017

57

tune letto 166x208xh125 cm con bande elastiche e trapunta quilt
in tessuto 07, laccato opaco sabbia / cm 166x208xh 125 cm with elastic
bands and quilt in fabric 07, sabbia matt lacquered





tune è accessoriabile anche con un capiente cassettone estraibile dotato di ruote / *it can also be accessorized with a large spacious pull-out drawer featuring wheels*



tune è accessoriabile anche con un capiente cassettone estraibile dotato di ruote / *it can also be accessorized with a large spacious pull-out drawer featuring wheels*



tune, bag

design Monica Graffeo

Scegliere la giusta sintonia.

Pochi elementi dai profili arrotondati, per realizzare tante configurazioni diverse, con un unico concetto di versatilità e accessibilità. La testiera laccata tune è accessoriabile con la trapunta quilt e con le bande elastiche Belt, ispirate alla copertina di un'agenda. La testiera bag è rivestita in tessuto ed ha una comoda tasca interna, come una grande pochette.

Choosing the perfect sync.

Just a few elements with rounded profiles, to create lots of different configurations, with a single concept of versatility and accessibility. The lacquered tune headboard is available with a quilt and belt elastic bands inspired by the cover of an agenda. The bag headboard is upholstered in fabric and has a convenient inner pocket, like a large pochette.

logica di collezione *collection logic*

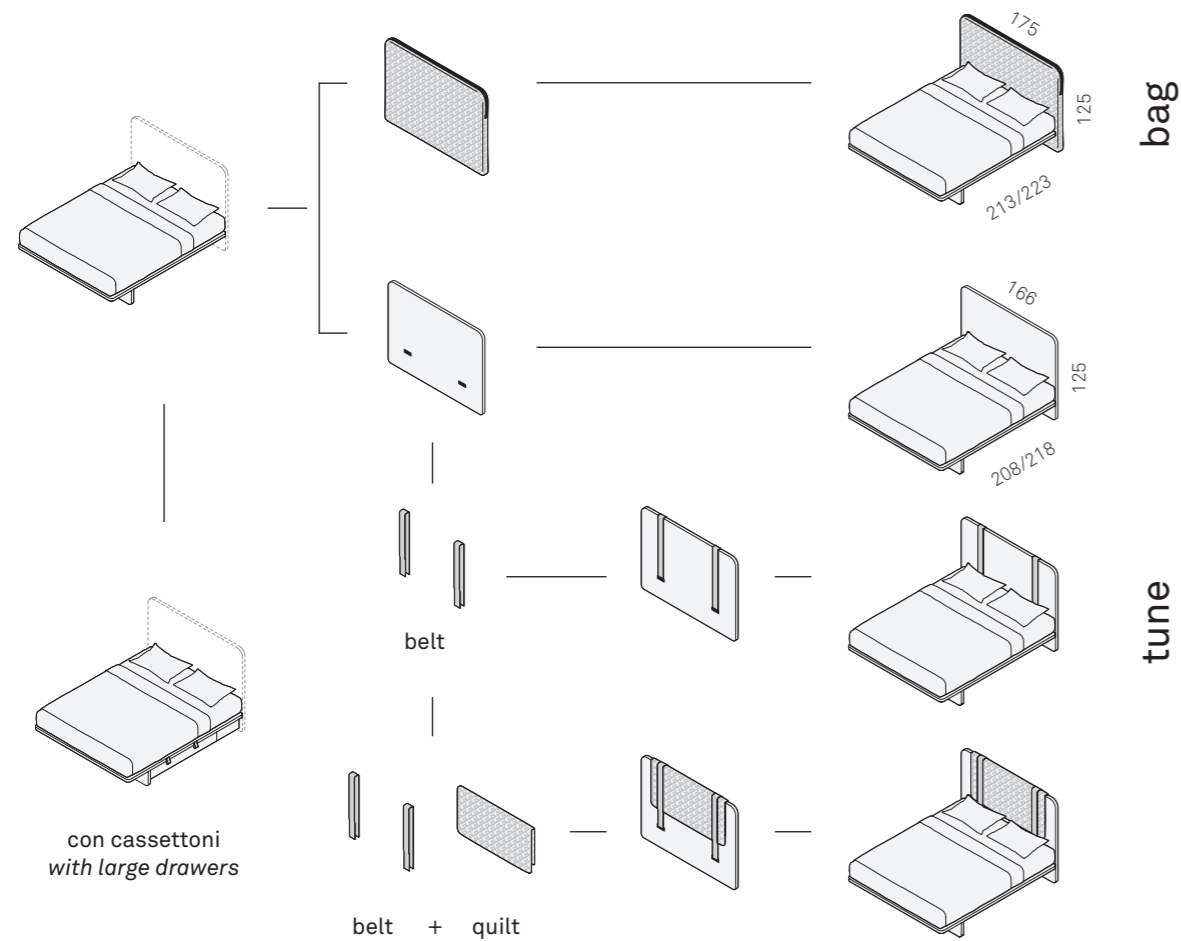

tune letto laccato opaco sabbia 166x208xh125 cm nelle varianti con e senza bande elastiche, trapuntino e cassettoni / cm 166x208xh125 sand matt lacquered bed in versions with and without elastic bands, quilt and large drawers

bag letto 175x213xh125 cm con testiera in tessuto quilt 10, base
in laccato opaco cenere / bed cm 175x213xh125 with quilt 10 fabric
headboard, base in ash matt lacquered





bag la tasca della testiera è un'idea semplice e intelligente,
per tenere sempre a portata di mano un piccolo mondo di oggetti /
*the pocket of the headboard is a simple and smart idea, to keep
a small world of objects always handy*

persone *people*

Condividiamo la nostra tradizione con un team di persone che lavorano insieme, valorizzando il patrimonio di conoscenza, ricerca e creatività di ognuno.

We share our tradition with a team of people who work together to promote the heritage of know-how, research and creativity of each of them.

idee *ideas*

Analizziamo l'evoluzione degli spazi domestici e collaboriamo con designer in sintonia con la nostra idea di progetto, come risposta alle nuove tendenze e intuizione di quelle future.

We analyze the evolution of home spaces and collaborate with designers in tune with our idea of project, as an answer to new trends and anticipation of future ones.

tecnologia *technology*

Siamo all'avanguardia nello *smart manufacturing*, con una gestione digitale dell'intero processo, dal progetto al prodotto finito, tutto all'interno dei nostri stabilimenti in Italia.

We are in the forefront when it comes to smart manufacturing, with digital management of the entire process, from the project through to the finished product, all inside our facilities in Italy.

affidabilità *reliability*

La durata nel tempo è il valore tangibile che nasce dalla nostra attenzione per la qualità, in ogni dettaglio: dalla scelta dei materiali, alla cura nella progettazione e nella realizzazione.

Long life is the tangible value that stems from our attention for quality, in every detail: from the choice of materials to care for design and manufacture.

sostenibilità *sustainability*

Rispettiamo la natura e proteggiamo il benessere delle persone, attraverso il rispetto per l'ambiente, l'utilizzo di materiali e processi sicuri per la salute, la riduzione dei consumi di energia.

We respect nature and protect the well-being of individuals, through environmental friendliness, the use of materials and processes which are safe for health and a reduction in energy consumption.

credits

art direction,
set design
Monica Graffeo

graphic design
Chiara Torelli

photo
Andrea Garuti
pp 48-49
Davide Lovatti

styling
Fulvia Carmagnini

pre-press,
printing
Lucegroup

thanks to

Discipline
Green Sounds
Lladró
Maria La Rosa
Prandina
Rosenthal

aprile *april* 2017

Caccaro srl
via Corse, 13 – 35010
Villa del Conte (Pd) Italy
+39 049 9318920
info@caccaro.com
caccaro.com



Spazi che parlano di te.
caccaro.com

