

 contardi

indoor



BLENDING
TECHNOLOGY
& CREATIVE
DESIGN

“Mentre mio padre stava dando forma alla luce, stavo imparando come modellare un’azienda”

Achille Carcano, Titolare



Paola & Achille Carcano

1. La nostra storia, la nostra famiglia *Our history, our family*

Contardi, una giovane azienda con una lunga storia. Il primo prodotto a marchio Contardi è stato lanciato nel 2006. Successivamente, l'azienda ha iniziato una crescita costante anno dopo anno, che si è consolidata negli ultimi anni a livello internazionale. Contardi è ora una solida realtà con sede produttiva ed amministrativa in Brianza, il cuore pulsante della manifattura Made in Italy. Tutto comincia grazie al genio creativo di Michele Carcano, che aveva una grande passione per la prototipazione. La sua esperienza nell'azienda Stilnovo gli consentì di sviluppare una notevole competenza nell'illuminazione. Da quel momento, gli eredi di Michele, Achille e Paola Carcano, hanno preso le redini dell'azienda e sono ora supportati da un team unito e compatto. Come in una famiglia allargata, alcuni dei suoi membri sono parte di Contardi sin dagli albori. Contardi è oggi sinonimo di servizio, qualità e flessibilità. Queste caratteristiche hanno consentito all'azienda di guadagnarsi la fiducia di architetti, interior designer e consulenti di illuminazione, figure professionali sempre alla ricerca di originalità e design decorativo e funzionale, oltre che di esperienza e servizio di alto livello.

We are a young company with a long history. Our first Contardi branded product dates back to 2006, thereafter the company began to constantly grow year after year, and the expansion has consolidated in the last six years. Contardi is now a well-established company headquartered in the Brianza district - the beating heart of the "Made in Italy" manufacturing. Before then, Contardi had a 30-year history of successful collaborations, providing its lighting expertise to some of the most iconic companies on the Italian design scene. It all started from the creative genius of Michele Carcano, who had a real passion for prototyping and worked for Stilnovo - one of the first companies to build a reputation in lighting design. Fast-forward to today, and Michele Carcano's heirs - Achille and Paola Carcano - have taken the reins of the company, supported by a very close-knit team, more similar to an extended family working together, with some of its members having been part of it since its inception. Contardi is now synonymous with service, quality and flexibility, having become a reliable reference point for architects, interior decorators and lighting consultants who are in search of original and well-designed decorative and functional lighting as well as an unparalleled expertise and service.

1a. Contardi USA

Il percorso aziendale di Contardi ha portato l'azienda ad affacciarsi sul mercato statunitense già nel 2015. Questo mercato ha oggi una grande importanza per il brand. Con l'apertura e presenza della filiale americana, Contardi risponde in tempo reale alle esigenze provenienti da questo mercato.

L'apertura della filiale americana ci garantisce un presidio diretto in uno dei punti nevralgici del mondo, con una forte presenza nell'e-commerce e l'ottenimento della certificazione ETL.

Contardi's business path led the company to enter the US market as early as 2015. Today this market is of great importance for the brand. With the opening and presence of the American branch, Contardi responds in real time to the needs of this market.

The American branch, which is ETL certified, guarantees our brand a direct participation in one of the key regions of the world, with a strong presence in e-commerce.

“While dad was giving a shape to light, I was learning how to shape a company”

Achille Carcano, Owner

2. Contardi Contract Division

Lavoriamo fianco a fianco con architetti, interior designer e consulenti di illuminazione. Grazie a questo, Contardi ha sviluppato la capacità sia di tradurre i concetti dei designer, che di soddisfare le richieste del cliente e di rispettare il budget dei progetti. **Hotels, ristoranti, e yacht** diventano il palcoscenico della versatilità dei nostri prodotti, che si uniscono perfettamente all'ambiente circostante, indipendentemente dallo stile e dalle caratteristiche del progetto stesso. La Divisione Contract Contardi offre un servizio mirato in base alle richieste del cliente:

*We work closely with architects, interior decorators and lighting designers, so we are able to catch and translate the designer's concepts, meeting the client's needs and the budget of the project. **Hotels, restaurants and yachts** become stages where the versatility of products blends perfectly with the surroundings, independently from the style and the characteristics of the project itself. Contardi Contract Division offers a dedicated service on customer requests:*

**BESPOKE
MODIFIED STOCK
VALUE ENGINEERED**



The Hoxton, Rome



Shangri La, Hong Kong



Mayfair Townhouse, London



The Address Downtown, Dubai



Lutetia Hotel, Paris



The Carlyle, New York

3. Sartorialità e tecnologia *Tailoring and avant-garde technology*

Per Contardi è stato più volte usato l'appellativo di **"Couturier della Luce"**. Nel corso degli anni, siamo riusciti a guadagnarci questa reputazione per il nostro approccio sartoriale, per la varietà dei materiali usati, per l'eleganza delle finiture e per la loro combinazione con le più innovative tecnologie LED. La nostra collezione è disegnata per assicurare che la qualità dell'illuminazione risponda alle esigenze contemporanee.

Internationally renowned as the "Couturier of Contemporary Lighting", we have earned this reputation over the years for our skilful sartorial approach, for the variety of materials used, as well as the elegance of the finishes combined with the most innovative LED technology, all designed to ensure that the quality of the lighting responds to contemporary requirements.

4. Flessibilità *Flexibility*

La flessibilità è la nostra forza. Ci contraddistingue. L'ampia varietà di stile rappresenta la capacità di interpretare le diverse personalità dei nostri clienti e di adattarsi a molteplici contesti.

Flexibility is our strength and what distinguishes us from the rest. Style variety does not mean a lack of identity though. On the contrary, it means a capacity to interpret different styles and to adapt to different settings.

5. Sostenibilità *Sustainability*

Il nostro impegno per un business sempre più sostenibile è costante. Siamo ora pronti per la nuova sfida di ridurre ulteriormente il nostro impatto ambientale con una serie di obiettivi che miriamo a raggiungere e che rappresentano il nostro orientamento in termini di sostenibilità.

Our commitment to an increasingly sustainable business has emerged over the course of the last few years and, after obtaining some great achievements, we are now ready for a new challenge to further reduce our environmental impact with a clear set of targets, which constitute our Pole Star in terms of sustainability.

6. Certificazioni *Certification*

La presenza di un Brand sul mercato internazionale non può oggi prescindere dalle certificazioni. Contardi risponde a questa esigenza investendo risorse e competenza. Oggi l'azienda è certificata ETL per il mercato americano e CCC per il mercato cinese. Grazie all'ufficio tecnico interno, Contardi riesce a soddisfare le richieste di certificazioni quali: SABER per l'Arabia Saudita, CoC per il Marocco, EAC per il mercato russo.

Today, a Brand's presence on the international market requires the ability to provide certifications. Contardi responds to this need by investing resources and expertise. Our company is ETL certified for the American market, and CCC for the Chinese market. Thanks to the internal technical office, Contardi is able to satisfy requests for certifications such as SABER for Saudi Arabia, CoC for Morocco, and EAC for the Russian market.



A	12 AIR 20 ARCIPELAGO so, ta 28 ASIA so, ap, ta, pl 38 AUDREY so, ta, fl
B	46 BEAM 52 BOGOTÀ
C	58 CALYPSO so, fl 76 CLESSIDRA 80 CUBE
D	84 DISCUS so, ap, pl 94 DORIAN so, fl
E	102 ECLISSE 2.0 106 EMMA ap, ta, pl
F	114 FLEXILED ap, fl 120 FLY so, ap, picture
G	132 G+T so, ap, reading, battery
K	146 KUBRIC
M	150 MANHATTAN 154 MELANOCETUS 160 MIKADO so, ap, ta, fl 172 MUSE LANTERN
O	176 ONGO battery

S	180 SOLITARIO so, ap, pl 190 STARDUST 194 STICK so, ap
T	206 TENEBRA wired, battery
U	212 UP ap, ta, fl
V	218 VEGAS

CONTARDI SARTORIA

Contardi Tailoring

A	2i ATHENA
C	6i CIRCUS so, pl 12i COCO MEGA & DELUXE ap, ta 16i COCO & COCONETTE
O	22i OVALE ta, fl
T	26i TONDA ap, ta, fl

Lampada a sospensione
Suspension lamp



Air
12

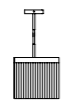

Arcipelago
20



Asia
28



Audrey
38



Bogotá
52



Calypso
58

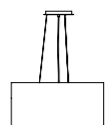

Circus & Circus LED
6i



Discus
84



Dorian
94

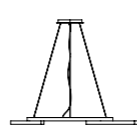

Eclisse 2.0
102

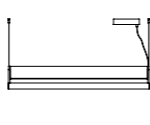

Fly
120



G+T
132



Kubric
146

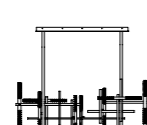

Mikado
160



Solitario
180

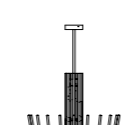

Stardust
190

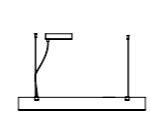

Stick
194

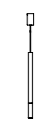

Tenebra
206



Vegas
218

Lampada a parete
Wall lamp

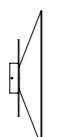

Asia
28

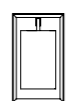

Coco Mega & Deluxe
12i

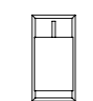

Coco & Coconette
16i



Discus
84



Emma
106



Flexiled
114



Fly
120



Fly picture
120



G+T
132



Manhattan
150

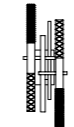

Mikado
160



Solitario
180



Stick
194



Tonda
26i



Up
212

Lampada da lettura
Reading lamp



Flexiled
114



G+T
132



Manhattan
150



Tonda
26i



Up
212

Lampada a soffitto
Ceiling lamp



Asia
28

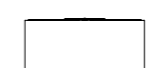

Circus & Circus LED
6i

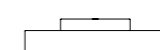

Discus
84



Emma
106



Melanocetus
154



Solitario
180

Lampada da terra
Floor lamp



Audrey
38

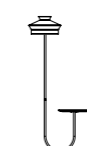

Calypso
58



Cube
80



Dorian
94



Flexiled
114



Mikado
160



Muse Lantern
172



Ovale
22i



Tonda
26i



Up
212

Lampada da tavolo
Table lamp



Arcipelago
20



Asia
28



Athena
2i



Audrey
38



Beam
46



Clessidra
76

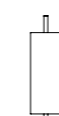

Coco Mega & Deluxe
12i



Emma
106



Mikado
160



Ongo
176



Ovale
22i

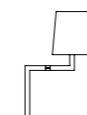

Tonda
26i



Up
212

Lampada a batteria
Battery lamp



G+T battery
132



Ongo
176



Tenebra
206

Air
Adam Tihany





DOPPIA EMISSIONE: LUCE DIRETTA E INDIRETTA
DOUBLE EMISSION: DIRECT AND INDIRECT LIGHT

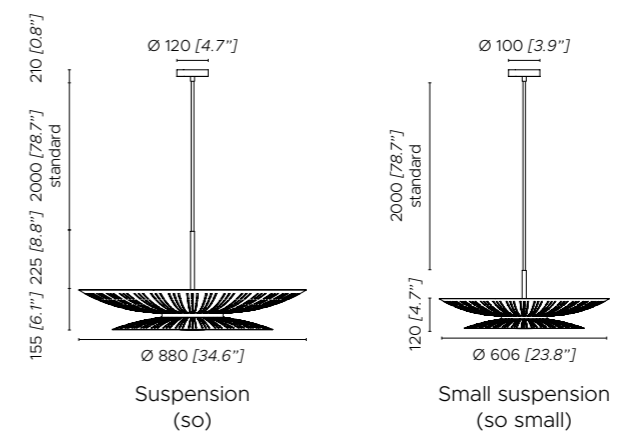

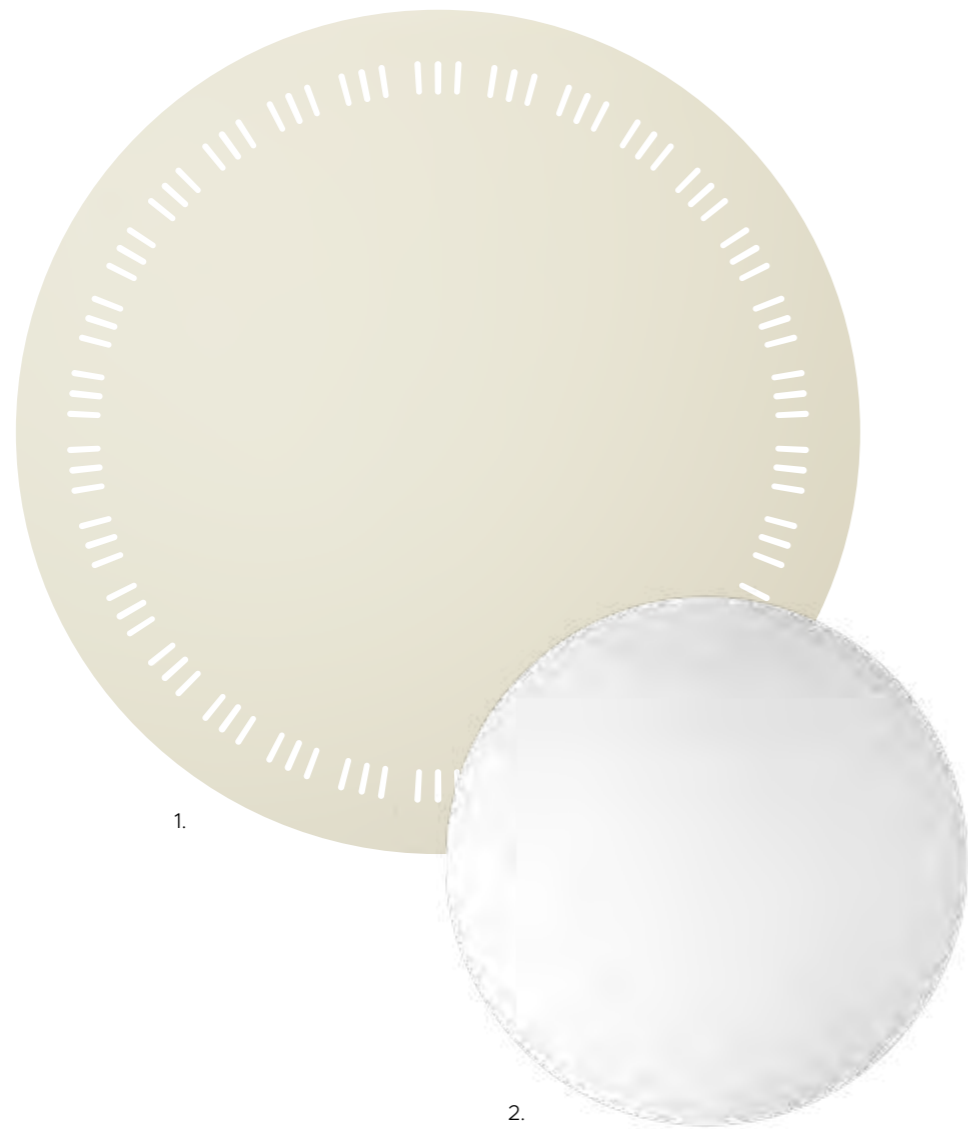

1. "GREEN CAST®" color crema

2. Diffusore "GREEN CAST®" bianco opale

ⓘ Disponibile su richiesta "GREEN CAST®" colore nero
Quantità minima: 5 pezzi per dimensione

1. Cream-coloured "GREEN CAST®"

2. Opal white "GREEN CAST®" diffuser

ⓘ Black-coloured "GREEN CAST®" available on demand
Minimum quantity: 5 pieces for size





WHAT'S AIR?

The eco-friendly AIR suspension light, conceived by the renowned **Adam Tihany**

Cos'è il materiale "GREEN CAST®"?

- **100%** granuli di PMMA provenienti da prodotti pre e post consumer
- Materia prima **100%** rigenerata

Quali sono i vantaggi del "GREEN CAST®"?

- **100%** riciclabile
- **Rispetto** delle risorse primarie
- **Riduzione** dell'uso di materie prime
- **Ri-utilizzo** di ciò che è considerato un rifiuto

What is "GREEN CAST®" material?

- **100%** PMMA granules from pre and post consumer
- **100%** regenerated raw material

Which are "GREEN CAST®" advantages?

- **100%** recyclable
- **Respect** of primary resources
- **Reduction** in the use of raw materials
- **Re-use** of what is considered waste

AIR FOR A MORE SUSTAINABLE IMPACT ON THE WORLD OF DESIGN

PER UN **IMPATTO PIÙ SOSTENIBILE NEL MONDO DEL DESIGN**



Fonte luminosa - Light source

220 - 240V:

So superiore/upper 1 x 7.5W Strip LED;
inferiore/lower 1 x 14.3W LED module; 2700 K; CRI: >90
So small superiore/upper 1 x 3.5W Strip LED;
inferiore/lower 1 x 9W LED module; 2700 K; CRI: >90

Dimmerazione a taglio di fase/Triac - altri sistemi di dimmerazione (DALI e 1-10V) disponibili su richiesta
Phase cut/Triac dimming - alternative dimming systems (DALI and 1-10V) available on demand

110V:

So superiore/upper 1 x 7.5W Strip LED;
inferiore/lower 1 x 14.3W LED module; 2700 K; CRI: >90
So small superiore/upper 1 x 3.5W Strip LED;
inferiore/lower 1 x 9W LED module; 2700 K; CRI: >90

Dimmerazione a taglio di fase/Triac - dimmerazione 1-10V disponibile su richiesta
Phase cut/Triac dimming - 1-10V dimming system available on demand

Arcipelago

Servomuto



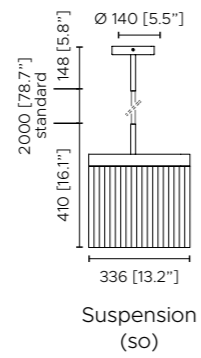



1. Struttura ottone satinato

- 2. Frange verde salvia
- 3. Frange blu nebbia
- 4. Frange cognac
- 5. Frange sabbia
- 6. Frange aragosta
- 7. Frange ruggine

Fonte luminosa - Light source

220 - 240V:
1 x 12W Custom LED; 3000 K; CRI: >90

1. Satin brass frame

- 2. Sage green colour fringes
- 3. Fog blue colour fringes
- 4. Cognac colour fringes
- 5. Sand colour fringes
- 6. Aragosta colour fringes
- 7. Rust colour fringes

110V:
1 x 12W Custom LED; 3000 K; CRI: >90

Ta
Dimmerabile a tre intensità sulla base (100% - 70% - 30%)
Dimmable with three intensity levels on the base (100% - 70% - 30%)

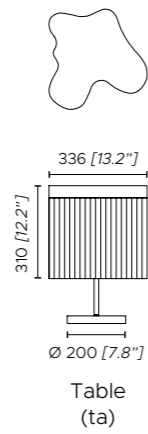

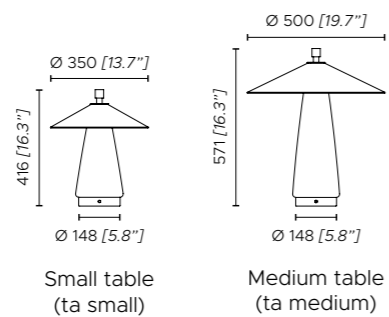

Small table
(ta small)Medium table
(ta medium)

1. Struttura nickel dorato satinato
2. Struttura bronzo-nickel spazzolato
3. Vetro trasparente

4. Paralume cotone bianco (esterno e interno)
5. Paralume cotone antracite (ta - so: esterno; ap - pl: interno) e cotone bianco (ta - so: interno; ap - pl: esterno)

6. Diffusore vetro bianco opale

1. Satin golden nickel frame
2. Brushed bronze-nickel frame
3. Transparent glass

4. White cotton shade (inside and outside)
5. Anthracite cotton shade (ta - so: outside; ap - pl: inside) and white cotton (ta - so: inside; ap - pl: outside)

6. Opal white glass diffuser

Fonte luminosa - Light source

220 - 240V:

- Ta small 1 x 13W Strip LED; 2700 K; CRI: >90
- Ta medium 1 x 20W Strip LED; 2700 K; CRI: >90
- Ap - pl small 1 x 32W COB LED; 2700 K; CRI: >90
- Ap - pl - so medium 1 x 37W COB LED; 2700 K; CRI: >90
- Ap - pl - so large 1 x 40W COB LED; 2700 K; CRI: >90

Ta

Dimmerabile, interruttore push sulla base
Dimmable, push switch on the base

Ap - pl - so

Dimmerazione a taglio di fase/Triac - altri sistemi di dimmerazione (DALI e 1-10V) disponibili su richiesta
Phase cut/Triac dimming - alternative dimming systems (DALI and 1-10V) available on demand

110V:

- Ta small 1 x 13W Strip LED; 2700 K; CRI: >90
- Ta medium 1 x 20W Strip LED; 2700 K; CRI: >90
- Ap - pl small 1 x 32W COB LED; 2700 K; CRI: >90
- Ap - pl - so medium 1 x 37W COB LED; 2700 K; CRI: >90
- Ap - pl - so large 1 x 40W COB LED; 2700 K; CRI: >90

Ta

Dimmerabile, interruttore push sulla base
Dimmable, push switch on the base

Ap - pl - so

Dimmerazione a taglio di fase/Triac - dimmerazione 1-10V disponibile su richiesta
Phase cut/Triac dimming - 1-10V dimming system available on demand



DOUBLE-SIDED SHADE,
**ANTHRACITE
& WHITE
COTTON**

DIFFUSORE BIFACCIALE, COTONE ANTRACITE E BIANCO



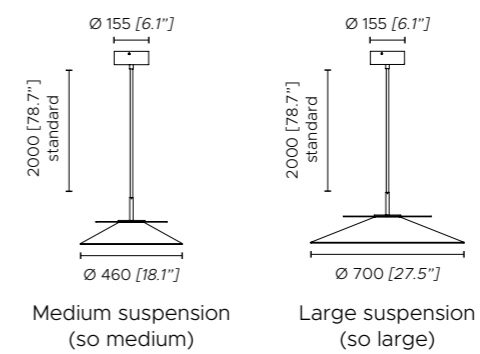
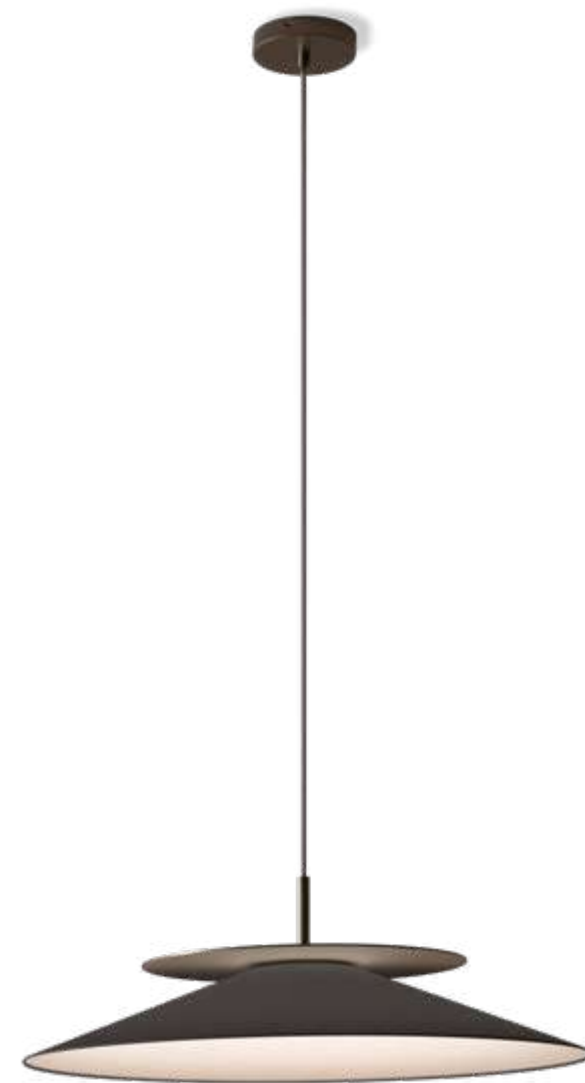

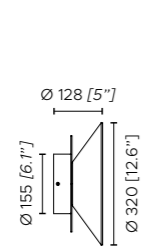

Small wall/ceiling
(ap/pl small)

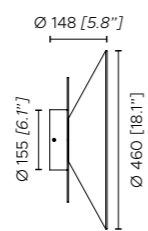

Medium wall/ceiling
(ap/pl medium)

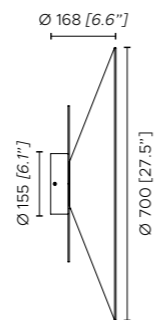

Large wall/ceiling
(ap/pl large)



Audrey

Massimiliano Raggi



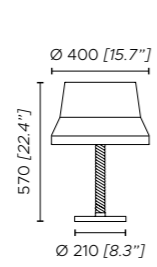

Medium table
(ta medium)

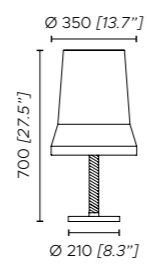

Large table
(ta large)



- 1. Base laccato nero lucido
- 2. Stelo in corda di seta intrecciata nera
- 3. Paralume cotone bianco
- 4. Bouclé color sabbia
- 5. Passamaneria in velluto senape
- 6. Passamaneria in velluto arancione
- 7. Passamaneria in velluto blu avio
- 8. Passamaneria in velluto nera

- 1. Glossy black lacquered base
- 2. Stem in black braided silk rope
- 3. White cotton shade
- 4. Sand colour bouclé
- 5. Mustard colour velvet trim
- 6. Orange colour velvet trim
- 7. Aviation blue colour velvet trim
- 8. Black colour velvet trim

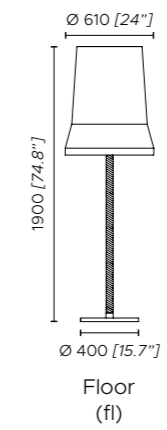

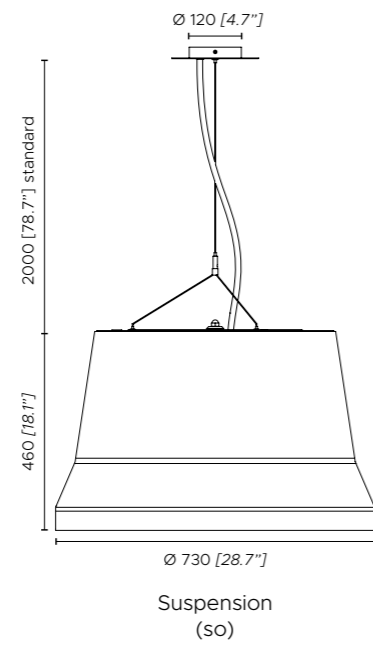

Fonte luminosa - Light source

220 - 240V:
Ta 1 x 13W E27 LED
FI - so 3 x 14W E27 LED

110V:
Ta 1 x 13W E26 LED
FI - so 3 x 14W E26 LED

Ta
Disponibile su richiesta versione con dimmer su cavo, compatibile solo con lampadine LED dimmerabili
Dimmer switch on the cable available on demand, compatible with dimmable LED light bulbs only

So
Compatibile con sistemi di controllo remoto in caso di utilizzo di lampadine LED dimmerabili
Compatible with remote control systems when dimmable LED bulbs are used



Beam

MKV Design





1. Laccato arancione scuro
2. Laccato bianco perla

ⓘ Altri colori disponibili su richiesta

Fonte luminosa - Light source

220 - 240V:
2 x 4W Strip LED; 2700 K; CRI: >90

1. Dark orange lacquered
2. Pearl white lacquered

ⓘ Other colours available on demand

110V:
2 x 4W Strip LED; 2700 K; CRI: >90

Luce orientabile (180°), tre posizioni: sinistra, destra, centrale - comando sulla base
Adjustable light (180°), three positions: left, right and central - switch on the base



1.



2.



3.

NON MUOVERE LA LAMPADA, MUOVI LA LUCE

DO NOT
MOVE THE
LAMP,
**MUOVE
THE
LIGHT**

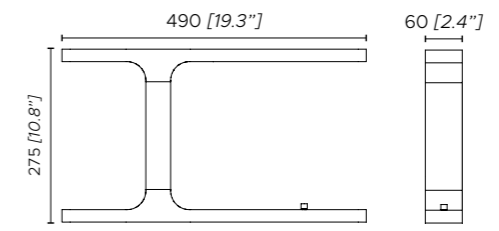

Bogotá

Massimiliano Raggi



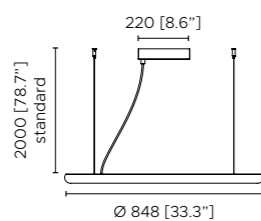

Small suspension
(so small)

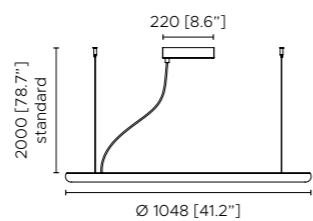

Large suspension
(so large)

1. Anello in legno tinto nero

- 2. Rivestimento diffusore in cotone bianco
- 3. Rivestimento diffusore in tessuto effetto marmo bianco Calacatta
- 4. Rivestimento diffusore in paglia di Vienna

1. Black stained wooden ring

- 2. White cotton diffuser
- 3. White Calacatta marble printed fabric diffuser
- 4. Vienna straw diffuser

Fonte luminosa - Light source

220 - 240V:

Small 1 x 39W Panel LED; 3000 K; CRI: >90
Large 1 x 48W Panel LED; 3000 K; CRI: >90

Dimmerazione a taglio di fase/Triac - altri sistemi di dimmerazione (DALI e 1-10V) disponibili su richiesta
Phase cut/Triac dimming - alternative dimming systems (DALI and 1-10V) available on demand

110V:

Small 1 x 39W Panel LED; 3000 K; CRI: >90
Large 1 x 48W Panel LED; 3000 K; CRI: >90

Dimmerazione a taglio di fase/Triac - dimmerazione 1-10V disponibile su richiesta
Phase cut/Triac dimming - 1-10V dimming system available on demand



EFFETTO **MARMO STAMPATO** SU TESSUTO
PRINTED MARBLE EFFECT ON FABRIC



PAGLIA DI VIENNA LAVORATA A MANO
HANDCRAFT VIENNA STRAW

Calypso

Servomuto







Suspension
(so)



- 1. Struttura ottone satinato
- 2. Corda in seta intrecciata verde muschio
- 3. **Paralume so:** Antigua, Guadaloupe, Martinique
- 4. Diffusore vetro trasparente

Fonte luminosa - Light source

220 - 240V:
1 x 14W E27 LED

- 1. Satin brass frame
- 2. Moss green braided silk rope
- 3. **So shade:** Antigua, Guadaloupe, Martinique
- 4. Transparent glass diffuser

110V:
1 x 14W E26 LED

Compatibile con sistemi di controllo remoto in caso di utilizzo di lampadine LED dimmerabili
Compatible with remote control systems when dimmable LED bulbs are used

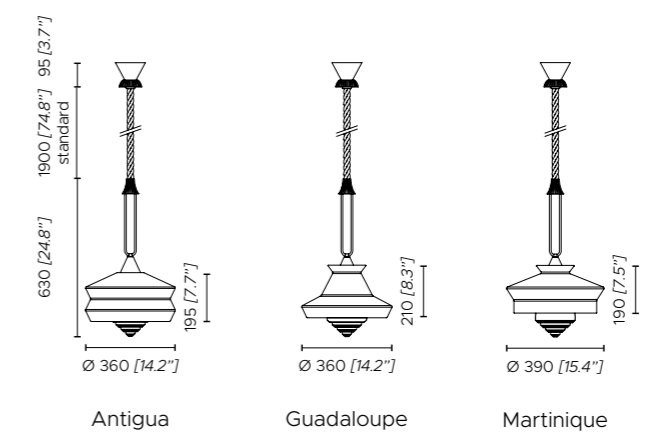





CALYPSO SO XL

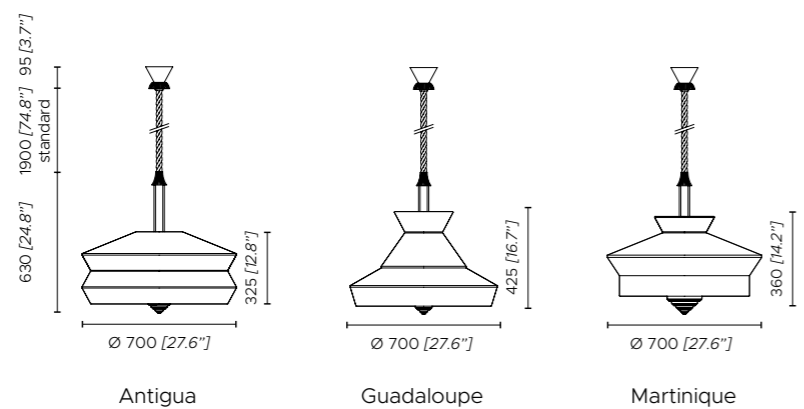

CALYPSO SO

CALYPSO SO XL



Antigua
Mint



Guadeloupe
Mint



Martinique
Yellow



Antigua
Mint



Antigua
Black



Guadeloupe
Black



Martinique
Black



Guadeloupe
Sale & Pepe



Antigua
Sale & Pepe



Guadeloupe
Sale & Pepe



Martinique
Building



Martinique
Yellow



CALYPSO
**FLOOR
+TABLE**

Servomuto

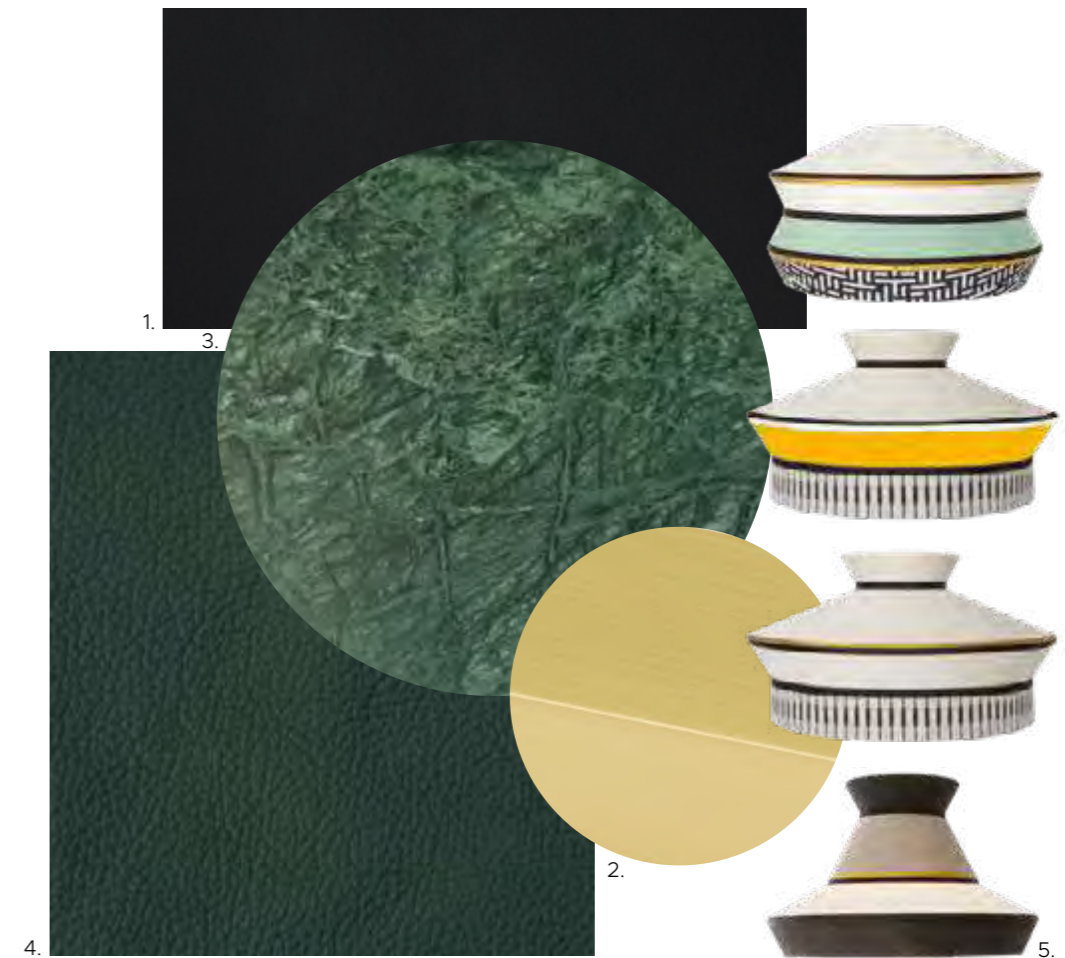
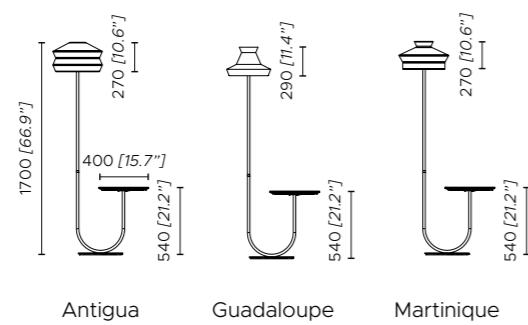

- 1. Struttura laccato nero seta opaco
- 2. Anello in ottone satinato
- 3. Marmo verde Guatemala
- 4. Pelle verde
- 5. **Paralume fl:** Antigua, Guadeloupe, Martinique

- 1. Matt black silk lacquered frame
- 2. Satin brass ring
- 3. Green Guatemala marble
- 4. Green leather
- 5. **FI shade:** Antigua, Guadeloupe, Martinique

Fonte luminosa - Light source

220 - 240V:
1 x 14W E27 LED dimmerabile - *dimnable*

110V:
1 x 14W E26 LED dimmerabile - *dimnable*

Dimmerabile a piede
Dimmable with foot control



DETAILS
MATTER:
**LEATHER,
MARBLE,
BRASS**

I DETTAGLI CONTANO: PELLE, MARMO, OTTONE

Clessidra

Massimiliano Raggi



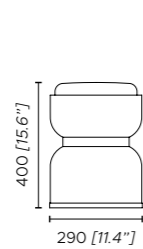

Kronos

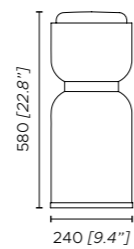

Kayros

1. Struttura bronzo-nickel spazzolato
2. Vetro soffiato metallizzato bronzo
3. Diffusore top superiore: vetro bianco lucido

Fonte luminosa - Light source

220 - 240V:
1 x 12W E27 LED + 1 x 10W E27 Filament LED

Doppio interruttore su cavo
Double switch on the cable

1. Brushed bronze-nickel frame
2. Bronze metallized blown glass
3. Upper top diffuser: glossy white glass

110V:
1 x 12W E26 LED + 1 x 10W E26 Filament LED



Cube

Massimiliano Raggi



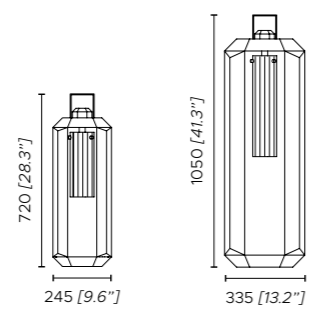

Small floor
(fl small)

Large floor
(fl large)



- 1. Struttura bronzo spazzolato
- 2. Interno laccato oro
- 3. Diffusore plexiglass rigato

Fonte luminosa - Light source

220 - 240V:
1 x 14W E27 LED dimmerabile - *dimnable*

Dimmerabile a piede
Dimmable with foot control

- 1. Satin bronze frame
- 2. Gold lacquered inside
- 3. Striped plexiglass diffuser

110V:
1 x 14W E26 LED dimmerabile - *dimnable*



Discus

MKV Design

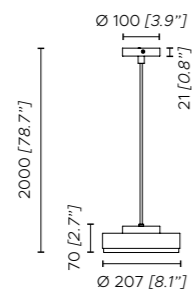
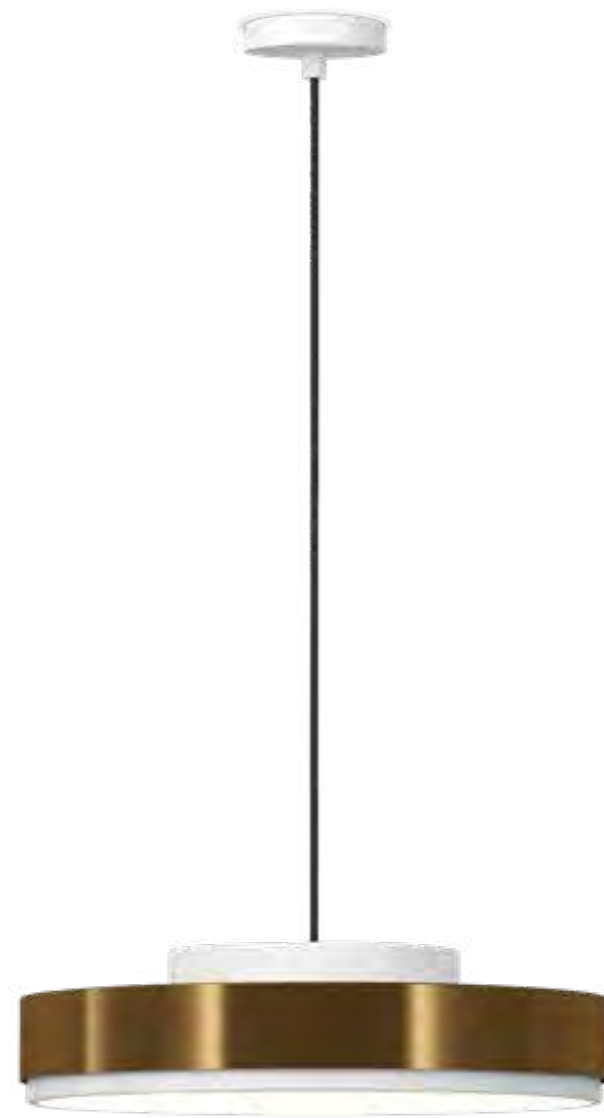

Small suspension
(so small)

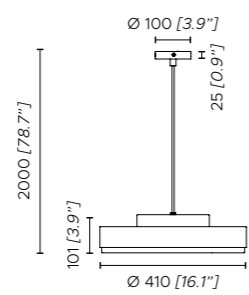

Large suspension
(so large)



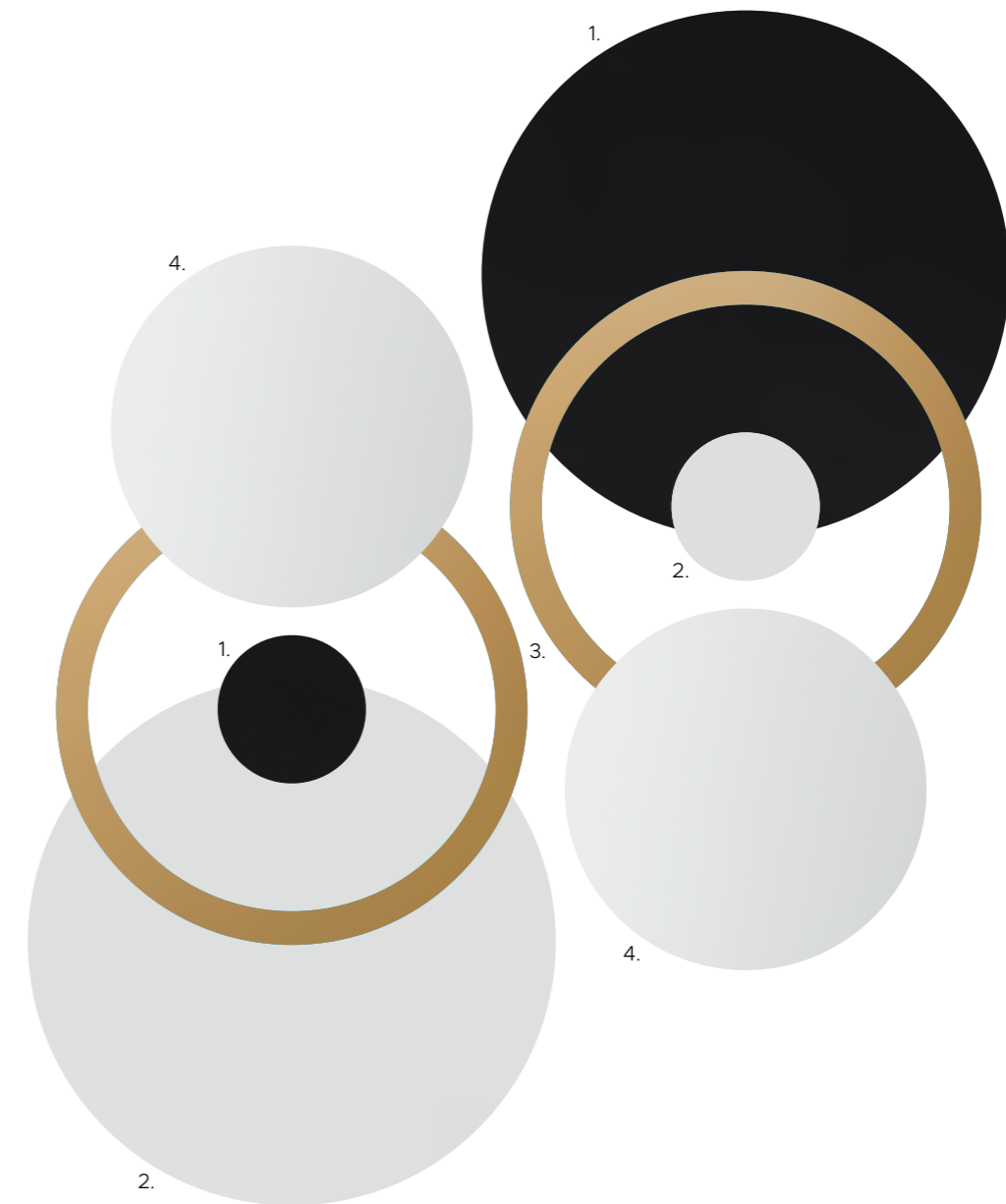
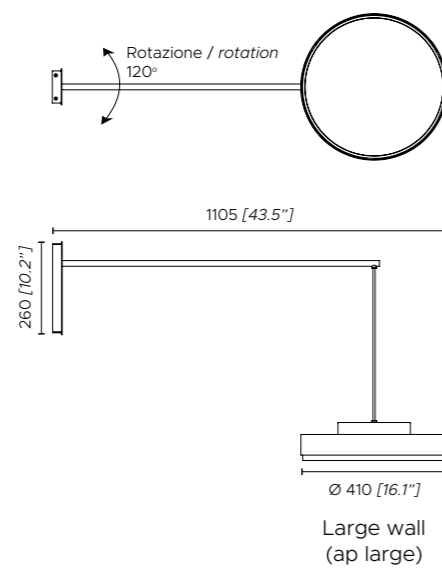

1. Laccato nero seta opaco
2. Laccato bianco opaco
3. Ottone semi-lucido
4. Diffusore bianco opaco

Fonte luminosa - Light source

220 - 240V:
So - ap - pl small 1 x 14.3W LED module; 2700 K; CRI: >90
So - ap - pl large 1 x 36W LED module; 2700 K; CRI: >90

Dimmerazione a taglio di fase/Triac - altri sistemi di dimmerazione (DALI e 1-10V) disponibili su richiesta
Phase cut/Triac dimming - alternative dimming systems (DALI and 1-10V) available on demand

1. Matt black silk lacquered
2. Matt white lacquered
3. Semi-polished brass
4. Opal white diffuser

110V:
So - ap - pl small 1 x 14.3W LED module; 2700 K; CRI: >90
So - ap - pl large 1 x 36W LED module; 2700 K; CRI: >90

Dimmerazione a taglio di fase/Triac - dimmerazione 1-10V disponibile su richiesta
Phase cut/Triac dimming - 1-10V dimming system available on demand

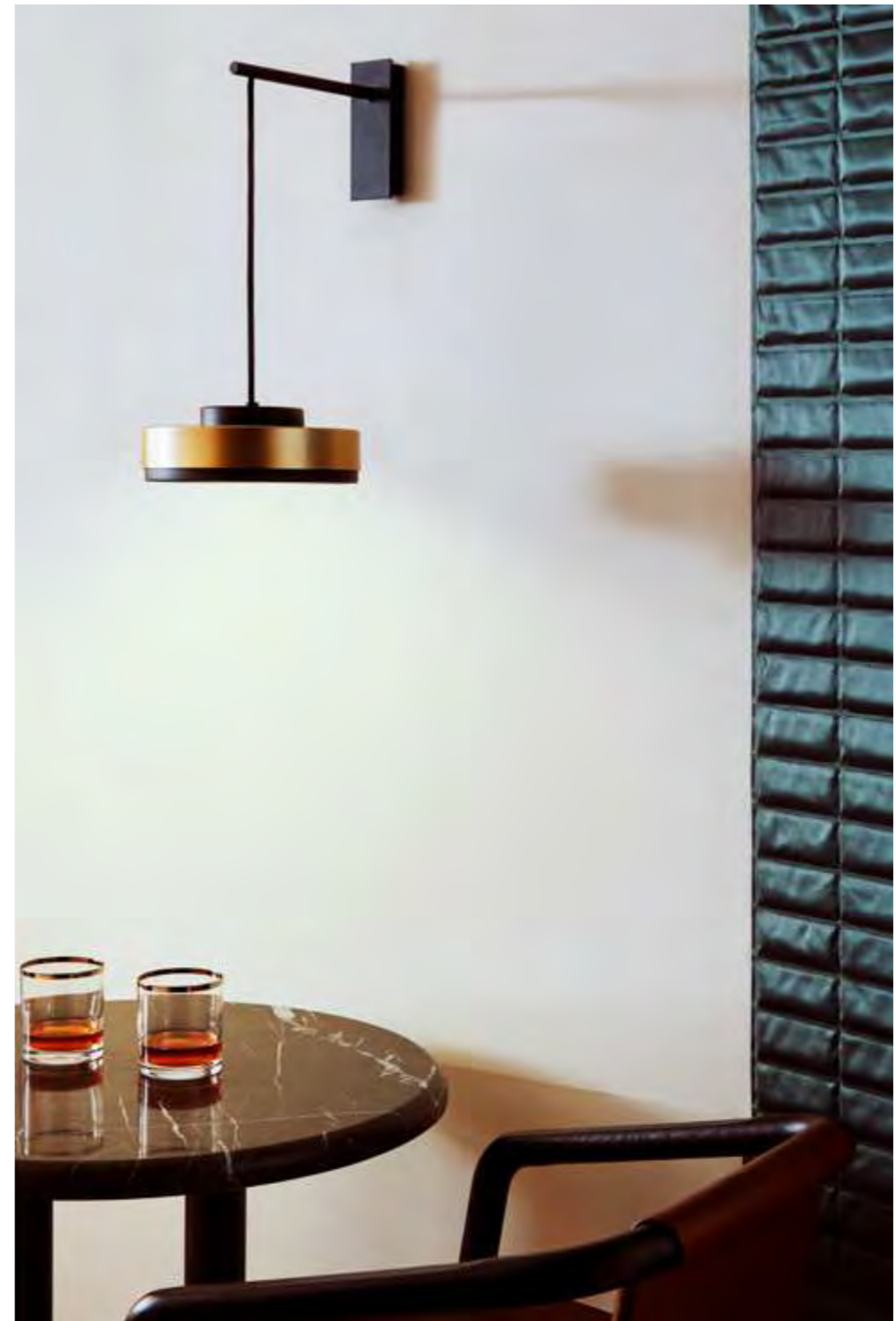
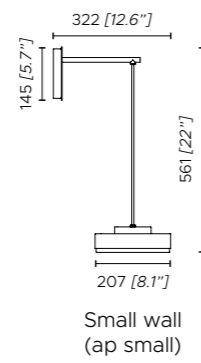

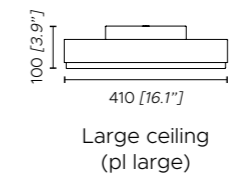
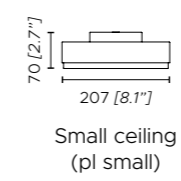

Dorian
Marcello Colli





1. Struttura bronzo spazzolato chiaro opaco
2. Struttura laccato nero seta opaco
3. Diffusore: specchio fumè, plexiglass con serigrafia a nido d'ape

Fonte luminosa - Light source

220 - 240V:

FI 1 x 55W Custom LED; 3000 K; CRI: >90
So small 1 x 17W Custom LED; 3000 K; CRI: >90

FI
Dimmerabile a piede
Dimmable with foot control

So small
Dimmerazione a taglio di fase/Triac - altri sistemi di dimmerazione (DALI e 1-10V) disponibili su richiesta
Phase cut/Triac dimming - alternative dimming systems (DALI and 1-10V) available on demand

1. Matt light satin bronze frame
2. Matt black silk lacquered frame
3. Diffuser: smoked coloured mirror, plexiglass with honeycomb effect screen printing

110V:

FI 1 x 55W Custom LED; 3000 K; CRI: >90
So small 1 x 17W Custom LED; 3000 K; CRI: >90

FI
Dimmerabile a piede
Dimmable with foot control

So small
Dimmerazione a taglio di fase/Triac - dimmerazione 1-10V disponibile su richiesta
Phase cut/Triac dimming - 1-10V dimming system available on demand



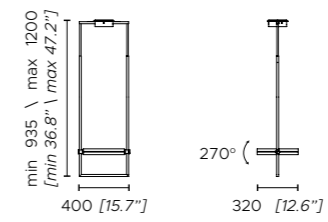

Small suspension
(so small)

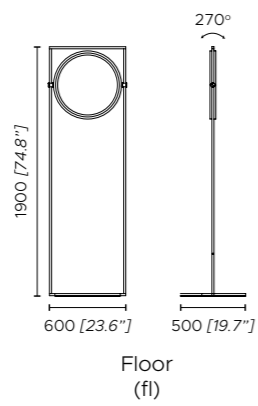

Eclisse 2.0

Massimiliano Raggi





1. Rosone bronzo spazzolato
2. Anello grande in legno bronzo scuro
3. Anelli piccoli in legno bronzo chiaro
4. Dischi diffusori in alicrite effetto alabastro

Fonte luminosa - Light source

220 - 240V:
1 x 28W Panel LED + 1 x 17W Panel LED;
3000 K; CRI: >90

Dimmerazione a taglio di fase/Triac - altri sistemi di dimmerazione (DALI e 1-10V) disponibili su richiesta
Phase cut/Triac dimming - alternative dimming systems (DALI and 1-10V) available on demand

1. Satin bronze canopy
2. Larger ring in dark bronze painted wood
3. Smaller rings in light bronze painted wood
4. Alabaster effect alycrite discs diffusers

110V:
1 x 28W Panel LED + 1 x 17W Panel LED;
3000 K; CRI: >90

Dimmerazione a taglio di fase/Triac - dimmerazione 1-10V disponibile su richiesta
Phase cut/Triac dimming - 1-10V dimming system available on demand

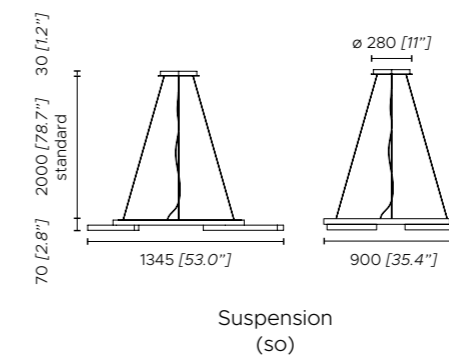

Emma
Contardi Studio



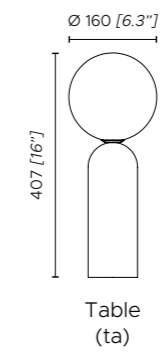

Fonte luminosa - Light source

220 - 240V:

Ap - pl 1 x 7W G9 LED

Ta 1 x 7W G9 LED dimmerabile - *dimnable*

110V:

Ap - pl 1 x 7W G9 LED

Ta 1 x 7W G9 LED dimmerabile - *dimnable*

Ap - pl

Compatibile con sistemi di controllo remoto in caso di utilizzo di lampadine LED dimmerabili
Compatible with remote control systems when dimmable LED bulbs are used

Ta

Dimmerabile su cavo
Dimmable on the cable

1. Marmo verde Guatemala
2. Marmo bianco Calacatta
3. Diffusore sfera bianca opale

1. Green Guatemala marble
2. White Calacatta marble
3. Opal white globe diffuser

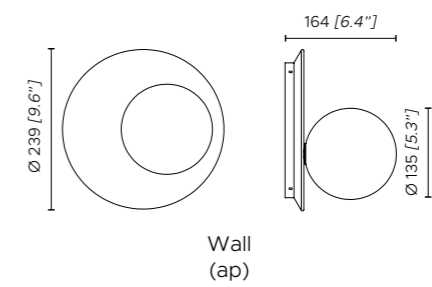
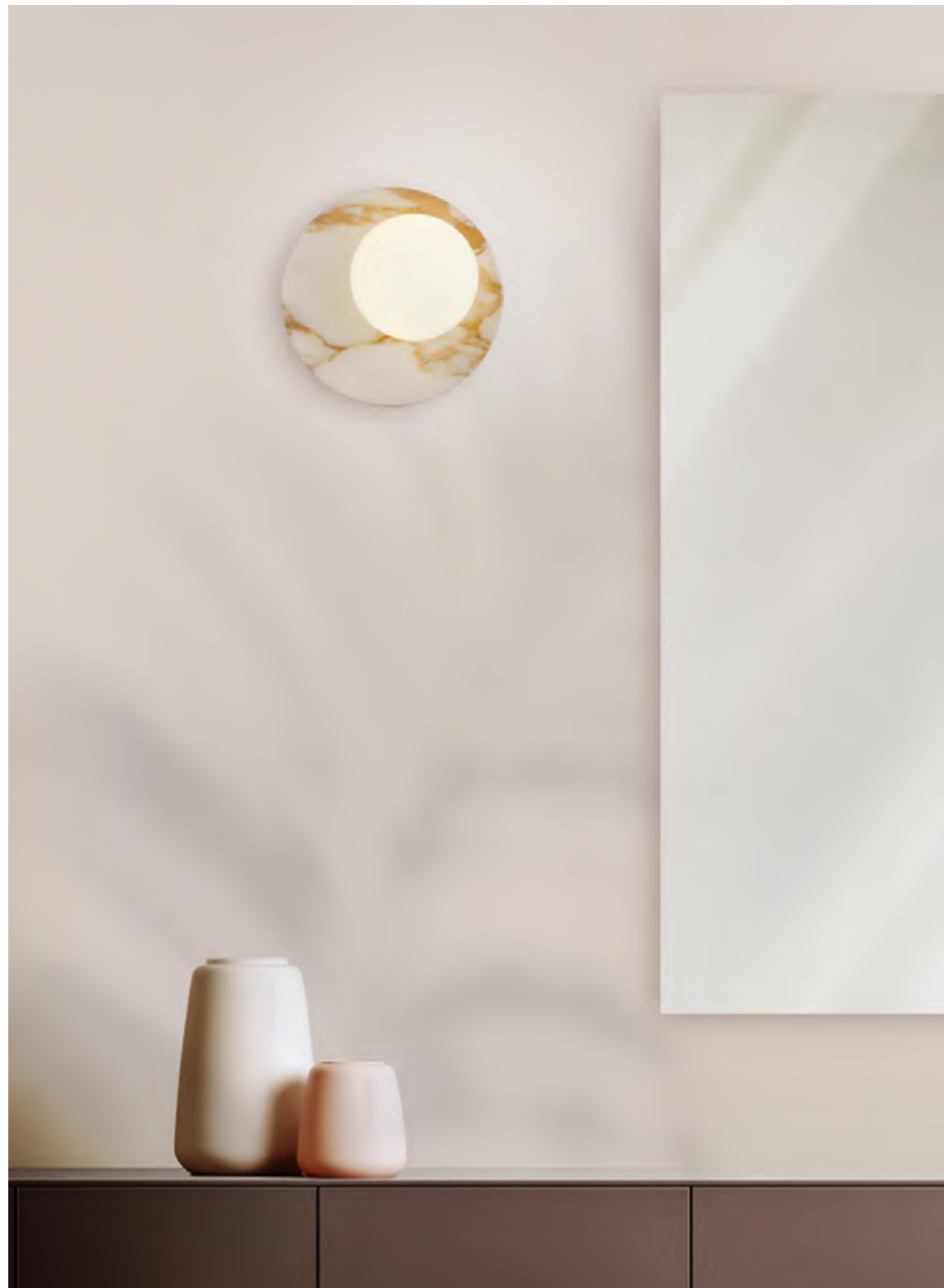

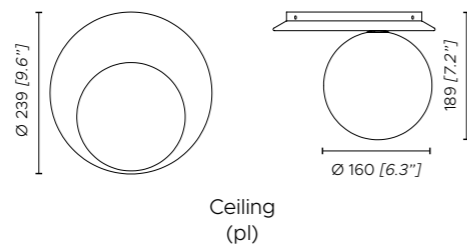

Flexiled

King & Roselli



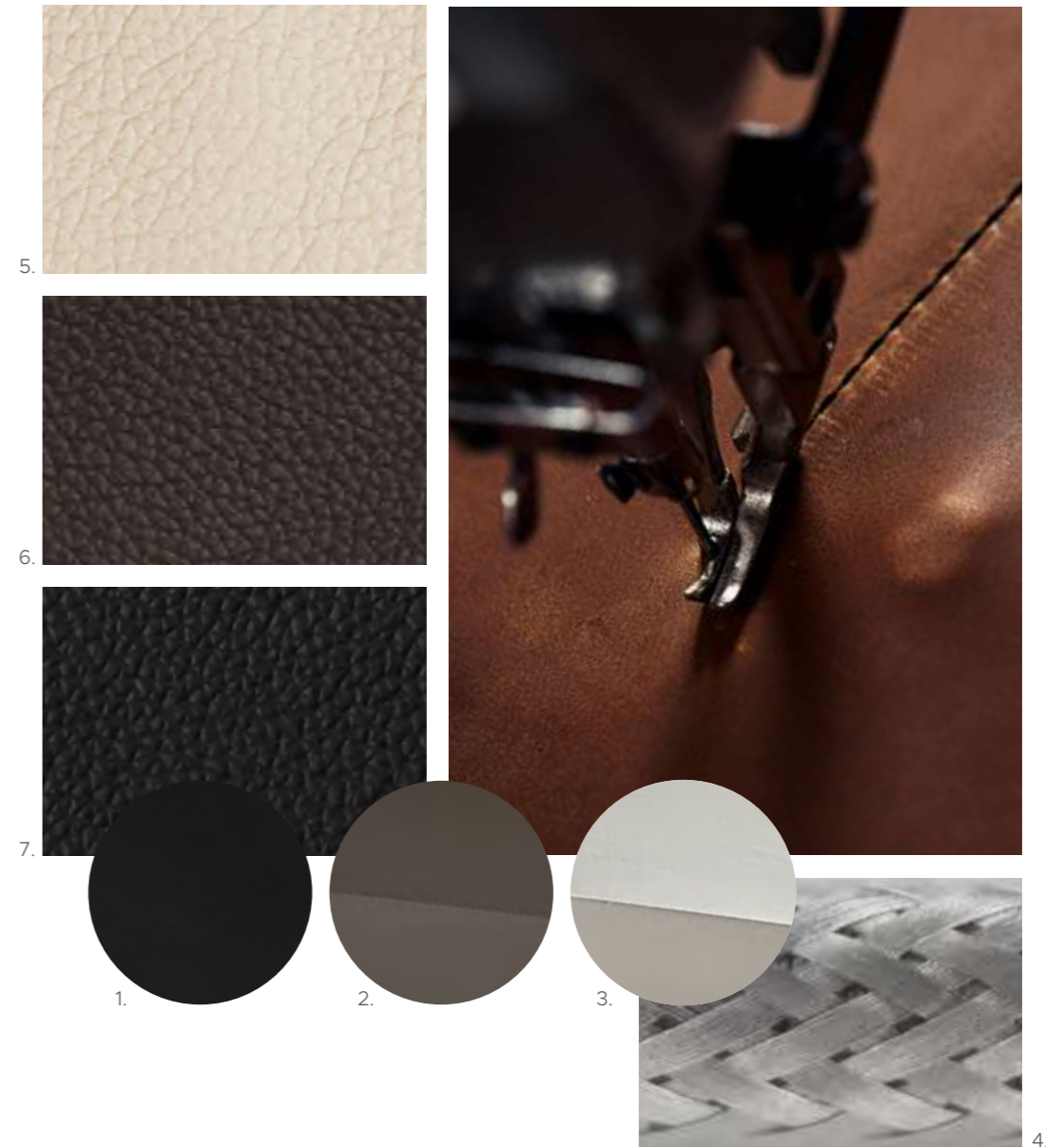
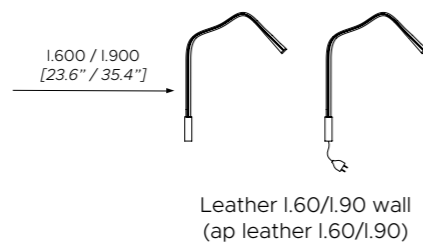

- 1. Base laccato nero seta opaco (floor lamp)
- 2. Base bronzo spazzolato (wall lamp)
- 3. Base nickel satinato (wall lamp)
- 4. Maglia d'acciaio intrecciato (wall lamp)
- 5. Pelle avorio
- 6. Pelle marrone testa di moro
- 7. Pelle nera

Fonte luminosa - Light source

220 - 240V:
Ap 1 x 3W LED module; 2700 K; CRI: >90
Fl 1 x 7W LED module; 2700 K; CRI: >90

FI
Dimmerabile a piede
Dimmable with foot control

- 1. Matt black silk lacquered base (floor lamp)
- 2. Satin bronze base (wall lamp)
- 3. Satin nickel base (wall lamp)
- 4. Braided steel mesh (wall lamp)
- 5. Ivory leather
- 6. Dark brown leather
- 7. Black leather

110V:
Ap 1 x 3W LED module; 2700 K; CRI: >90
Fl 1 x 7W LED module; 2700 K; CRI: >90

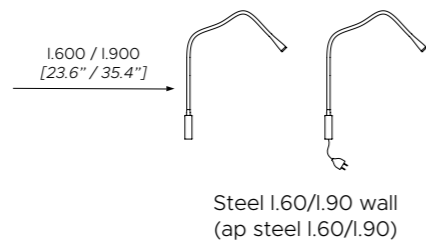
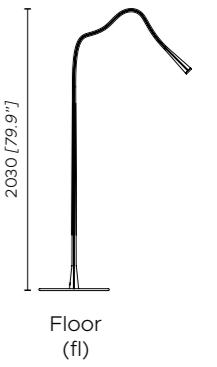

Fly

Massimiliano Raggi



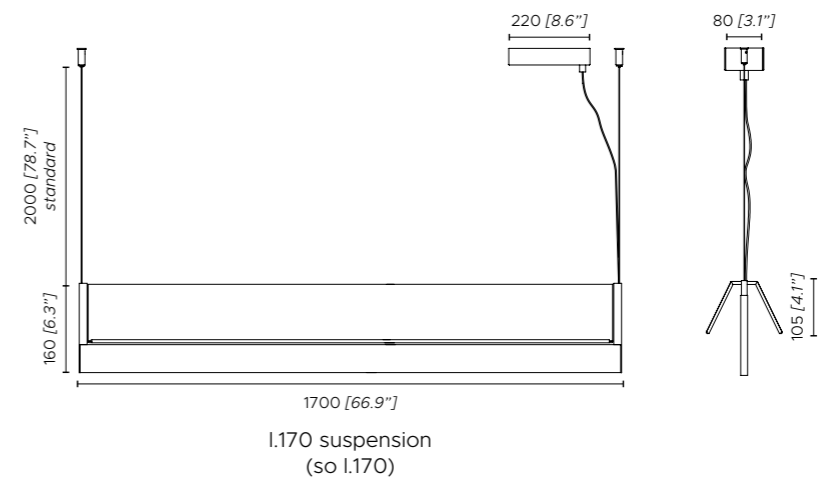
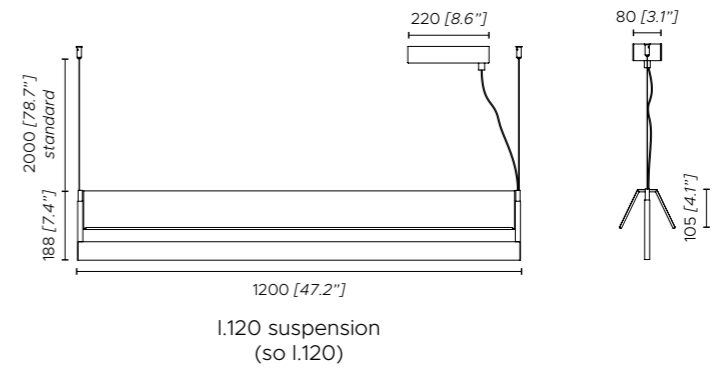
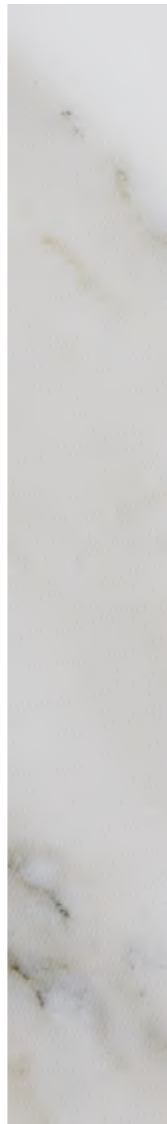

DOPPIA EMISSIONE: LUCE DIRETTA E INDIRETTA
DOUBLE EMISSION: DIRECT AND INDIRECT LIGHT



Fonte luminosa - Light source

220 - 240V:

So I.120 superiore/*upper* 1 x 17W Strip LED;
 inferiore/*lower* 1 x 23W Strip LED; 2700 K; CRI: >90
 So I.150 superiore/*upper* 1 x 24W Strip LED;
 inferiore/*lower* 1 x 30W Strip LED; 2700 K; CRI: >90

Dimmerazione a taglio di fase/Triac - altri sistemi
 di dimmerazione (DALI e 1-10V) disponibili su richiesta
Phase cut/Triac dimming - alternative dimming systems
 (DALI and 1-10V) available on demand

110V:

So I.120 superiore/*upper* 1 x 17W Strip LED;
 inferiore/*lower* 1 x 23W Strip LED; 2700 K; CRI: >90
 So I.150 superiore/*upper* 1 x 24W Strip LED;
 inferiore/*lower* 1 x 30W Strip LED; 2700 K; CRI: >90

Dimmerazione a taglio di fase/Triac - dimmerazione
 1-10V disponibile su richiesta
Phase cut/Triac dimming - 1-10V dimming system
 available on demand

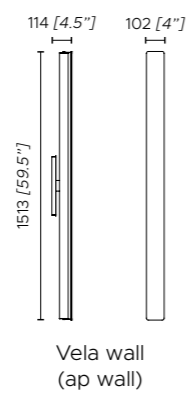
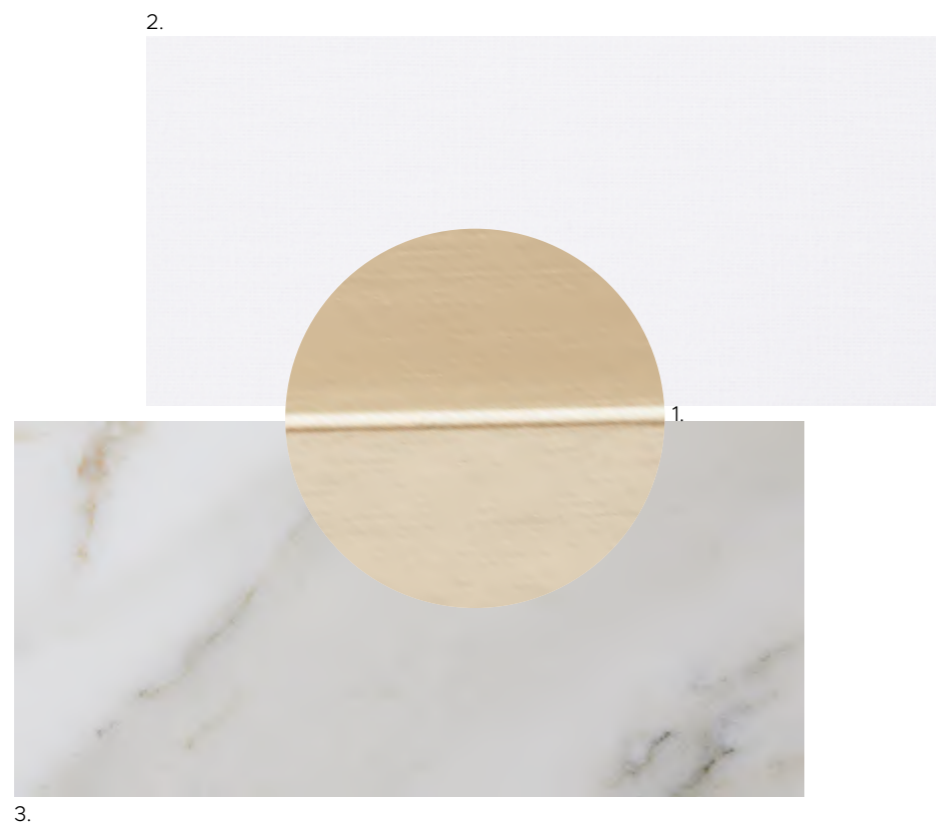

- 1. Struttura nickel dorato satinato
- 2. Cotone bianco
- 3. Tessuto effetto marmo bianco Calacatta

Fonte luminosa - Light source

220 - 240V:
Ap - ap vela fronte/front 1 x 20W Strip LED;
 retro/back 1 x 30W Strip LED; 2700 K; CRI: >90

Dimmerazione a taglio di fase/Triac - altri sistemi di dimmerazione (DALI e 1-10V) disponibili su richiesta
Phase cut/Triac dimming - alternative dimming systems (DALI and 1-10V) available on demand

- 1. Satin golden nickel frame
- 2. White cotton
- 3. White Calacatta marble printed fabric

110V:
Ap - ap vela fronte/front 1 x 20W Strip LED;
 retro/back 1 x 30W Strip LED; 2700 K; CRI: >90

Dimmerazione a taglio di fase/Triac - dimmerazione 1-10V disponibile su richiesta
Phase cut/Triac dimming - 1-10V dimming system available on demand

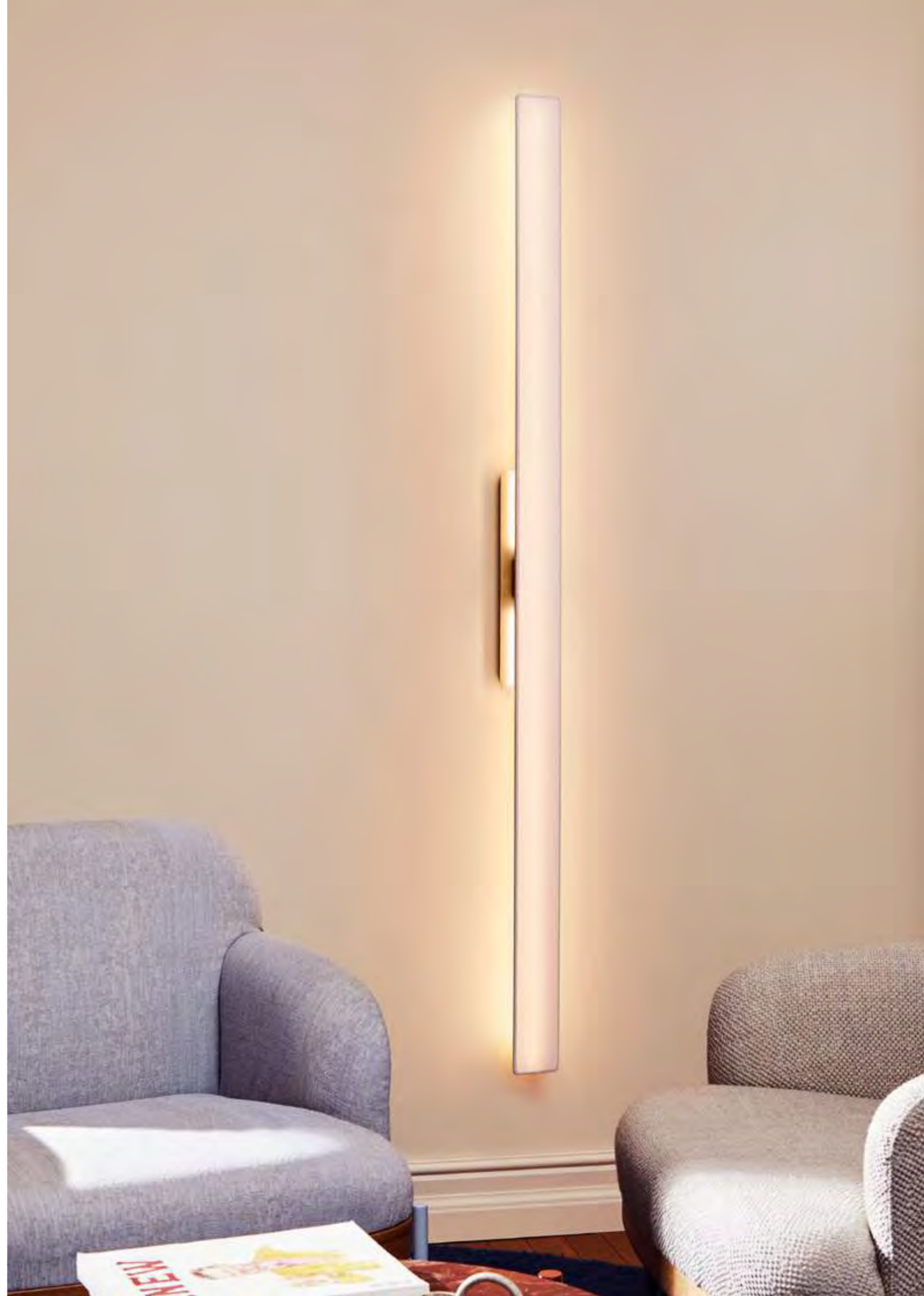

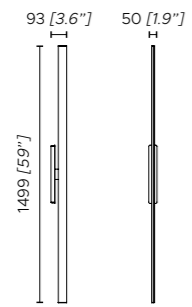

Wall
(ap)

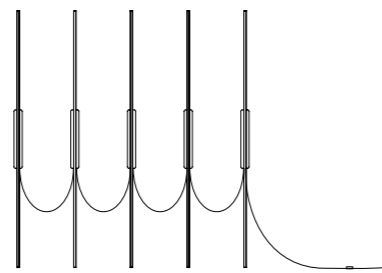

Composizione esempio Fly ap (max. 5 lampade) /
Example of Fly ap modular system (max. 5 lamps)

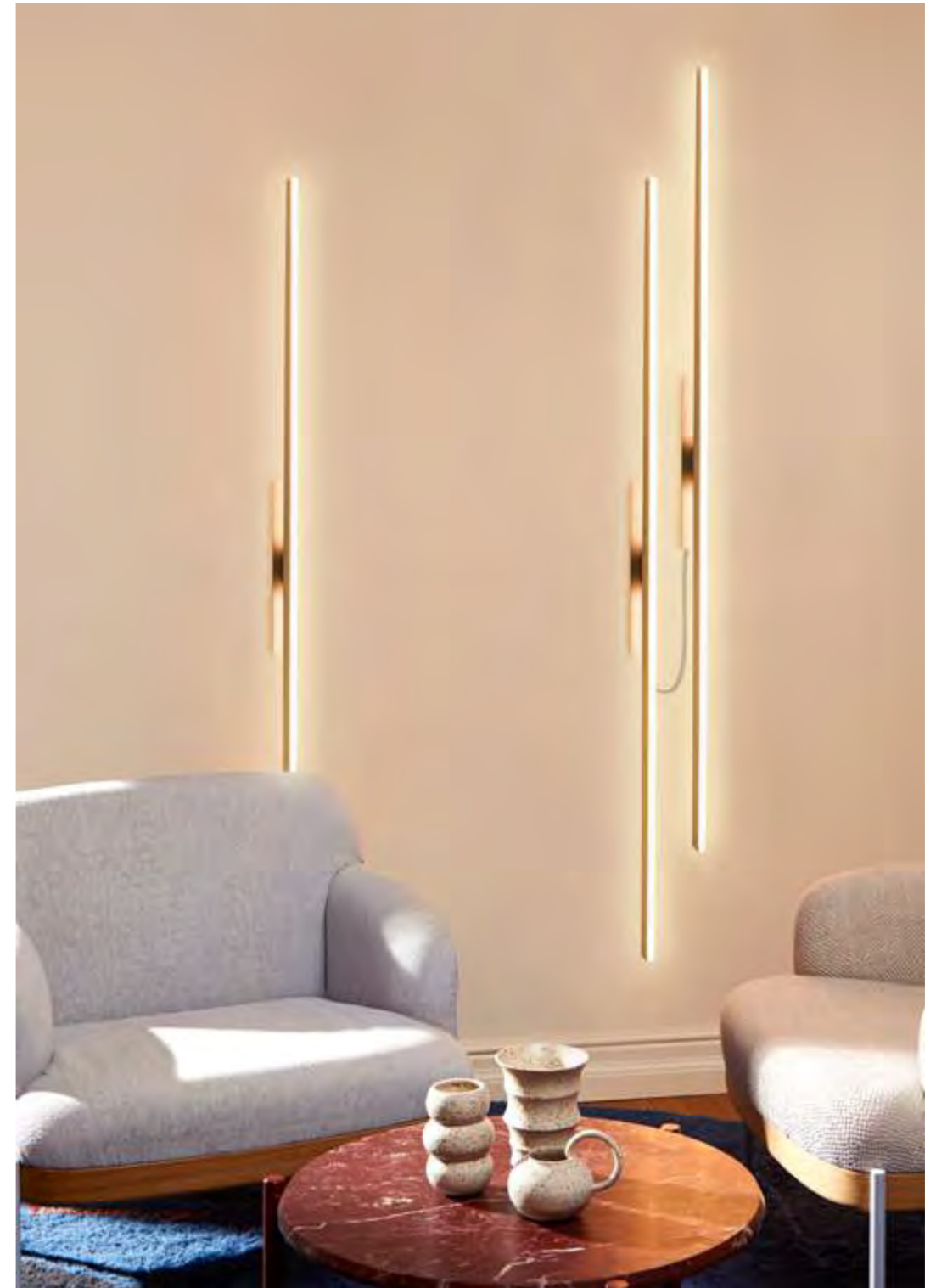

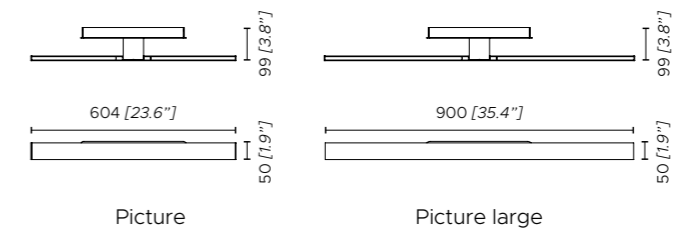

Fonte luminosa - Light source

220 - 240V:

Picture 1 x 12W Strip LED; 2700 K; CRI: >90
 Picture large 1 x 18W Strip LED; 2700 K; CRI: >90

Dimmerazione a taglio di fase/Triac - altri sistemi di dimmerazione (DALI e 1-10V) disponibili su richiesta
 Phase cut/Triac dimming - alternative dimming systems (DALI and 1-10V) available on demand

110V:

Picture 1 x 12W Strip LED; 2700 K; CRI: >90
 Picture large 1 x 18W Strip LED; 2700 K; CRI: >90

Dimmerazione a taglio di fase/Triac - dimmerazione 1-10V disponibile su richiesta
 Phase cut/Triac dimming - 1-10V dimming system available on demand

G+T

Jan Van Lierde



2000 [78.7"] 80 [3.1"]
standard
404 [15.9"]
50 [1.9"]
Suspension
(so)



VERSIONE **CABLATA** / **WIRED VERSION**



Porta USB per ricaricare dispositivi elettronici
USB port for charging electronic devices

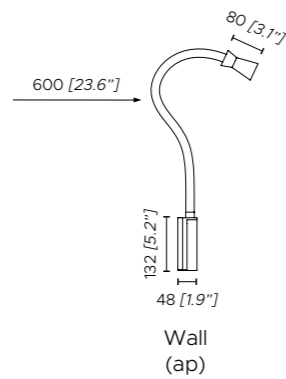

- 1. Laccato nero seta opaco (suspension lamp - reading lamp)
- 2. Bronzo rame lucido
- 3. Nickel lucido

- 4. Pelle intrecciata marrone testa di moro

Fonte luminosa - Light source

220 - 240V:
1 x 3W LED module; 2700 K; CRI: >90

Ap - battery
Dimmerabile, comando a tre livelli (100% - 70% - 30%)
Dimmable, three levels control (100% - 70% - 30%)

- 1. Matt black silk lacquered (suspension lamp - reading lamp)
- 2. Polished copper bronze
- 3. Polished nickel

- 4. Dark brown braided leather

110V:
1 x 3W LED module; 2700 K; CRI: >90



VERSIONE **A BATTERIA** / **BATTERY OPERATED VERSION**

FISSAGGIO PER **TAVOLO**

TABLE FIXING ACCESSORY

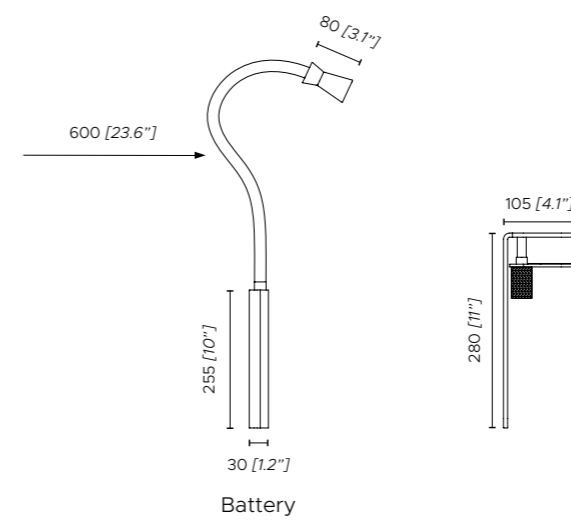

Battery

Dimmerabile: 3 intensità (100% - 70% - 30%)
Dimmable: 3 steps (100% - 70% - 30%)

VERSIONE A BATTERIA / BATTERY OPERATED VERSION



FISSAGGIO A PARETE

WALL FIXING ACCESSORY

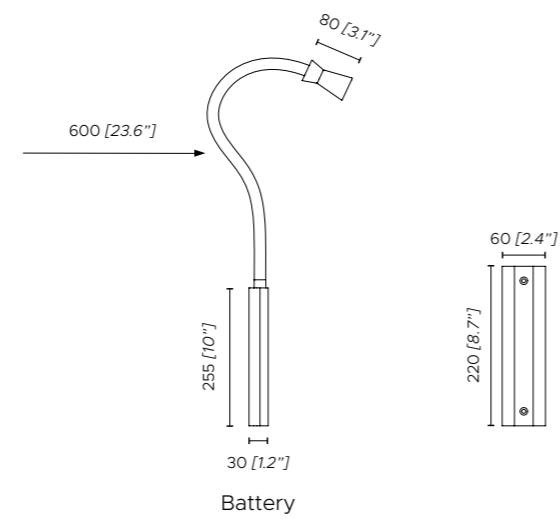

Dimmerabile: 3 intensità (100% - 70% - 30%)
Dimmable: 3 steps (100% - 70% - 30%)





VERSIONE A BATTERIA / BATTERY OPERATED VERSION

FISSAGGIO PER POLTRONE E DIVANI

SEATS & SOFAS FIXING ACCESSORY

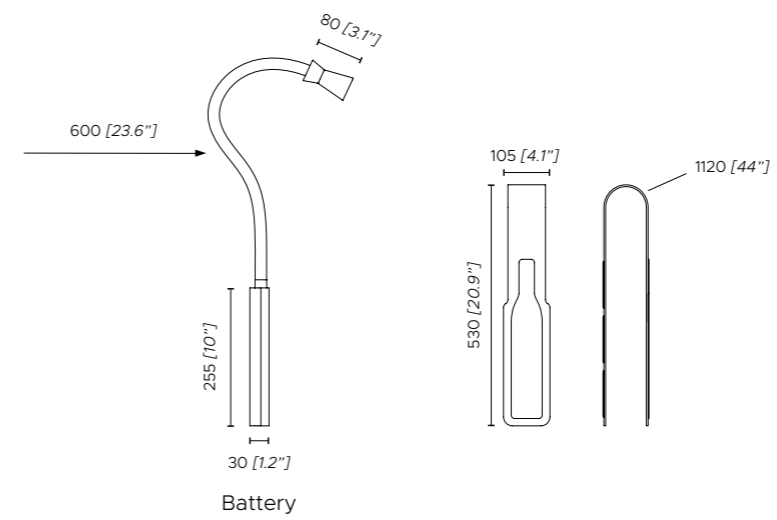

Dimmerabile: 3 intensità (100% - 70% - 30%)
Dimmable: 3 steps (100% - 70% - 30%)

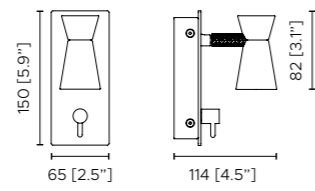

Reading



Kubric

Massimiliano Raggi



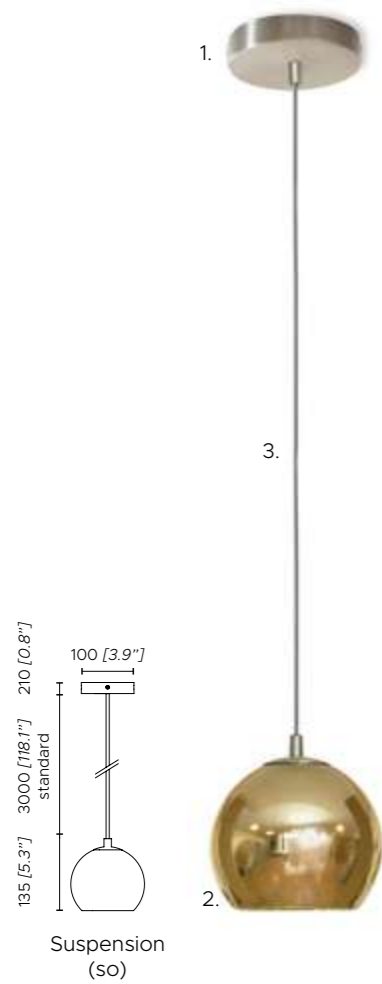

- 1. Struttura nickel dorato satinato
- 2. Vetro bronzo lucido con interno oro
- 3. Cavo tessuto color sabbia

(i) Altri colori su richiesta

Fonte luminosa - Light source

220 - 240V:
1 x 5W LED module; 2700 K; CRI: >90

Dimmerazione a taglio di fase/Triac
Phase cut/Triac dimming

- 1. Satin golden nickel frame
- 2. Polished bronze glass with gold painted inside
- 3. Sand colour fabric cable

(i) Other colours available on demand

110V:
1 x 5W LED module; 2700 K; CRI: >90

Dimmerazione a taglio di fase/Triac - dimmerazione 1-10V disponibile su richiesta
Phase cut/Triac dimming - 1-10V dimming system available on demand

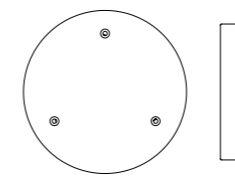

Cluster Ø 300 mm
3 sospensioni
3 suspensions

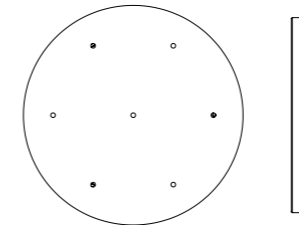

Cluster Ø 500 mm
7 sospensioni
7 suspensions

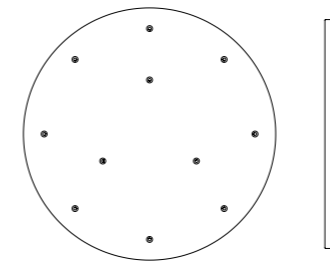

Cluster Ø 700 mm
11 sospensioni
11 suspensions

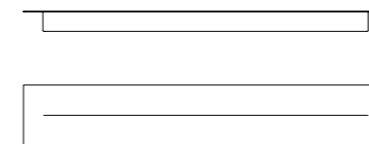

Cluster L.900 mm
Fino a 6 sospensioni
Up to 6 suspensions

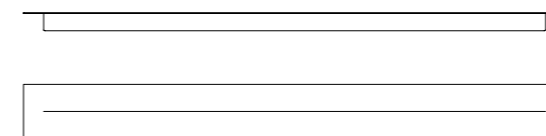

Cluster L.1500 mm
Fino a 10 sospensioni
Up to 10 suspensions

*(i) Altre composizioni su richiesta
Other compositions available on demand*

Manhattan

Contardi Studio



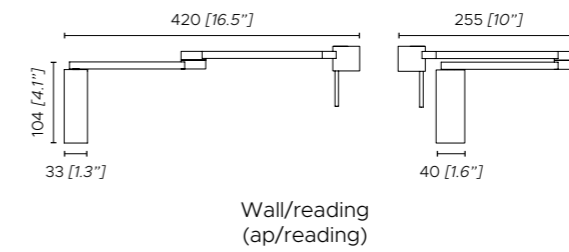
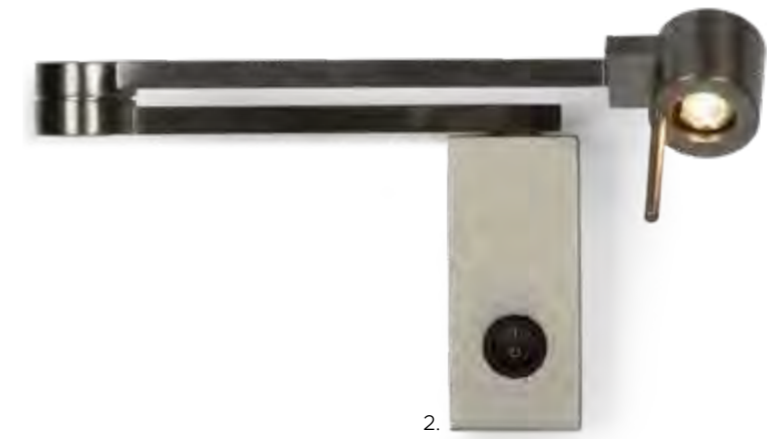
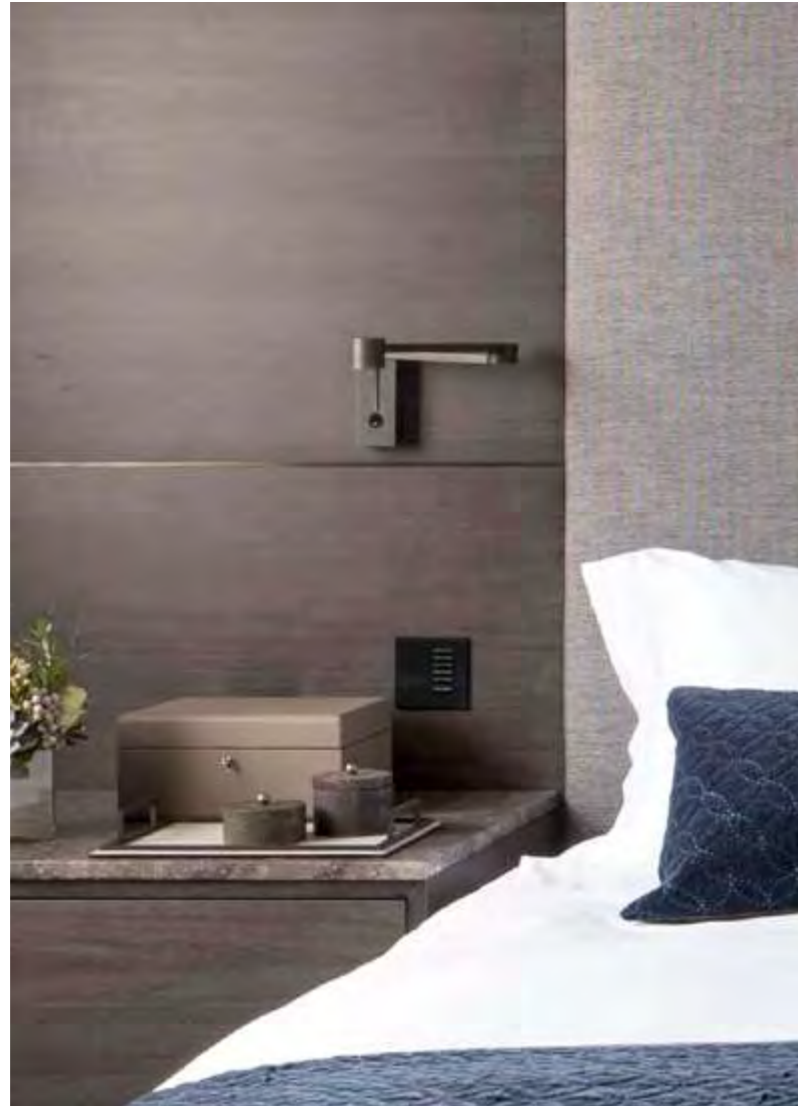

APRI / **OPEN**

RUOTA / **TURN**

CHIUDI / **CLOSE**

- 1. Bronzo spazzolato
- 2. Nickel satinato

- 1. Satin bronze
- 2. Satin nickel

Fonte luminosa - Light source

220 - 240V:
1 x 3W LED module; 2700 K; CRI: >90

110V:
1 x 3W LED module; 2700 K; CRI: >90



Melanocetus

Tristan Auer

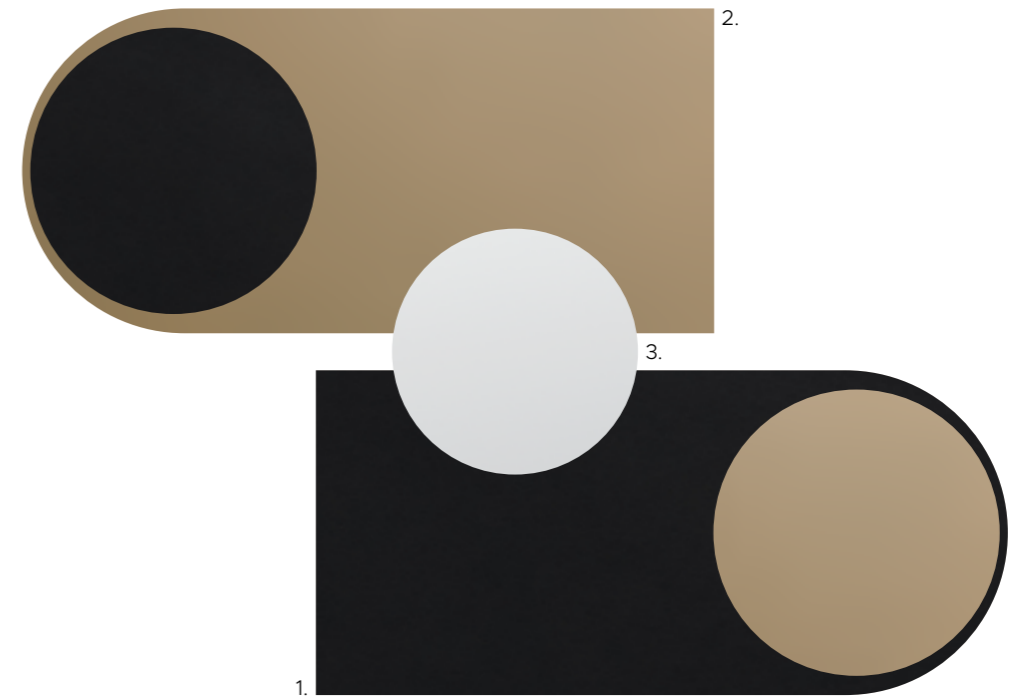

1. Nero opaco con dettagli oro satinato
2. Oro satinato con dettagli nero opaco

3. Diffusore: plexiglass satinato

Fonte luminosa - Light source

220 - 240V:

PI 2 x 7.5W GU10 LED dimmerabile - *dimnable*;
3000 K; CRI: >90

PI double 4 x 7.5W GU10 LED dimmerabile -
dimnable; 3000 K; CRI: >90

1. Matt black lacquered with satin gold details
2. Satin gold with matt black lacquered details

3. Diffuser: satin plexiglass

110V:

PI 2 x 7.5W GU10 LED dimmerabile - *dimnable*;
3000 K; CRI: >90

PI double 4 x 7.5W GU10 LED dimmerabile -
dimnable; 3000 K; CRI: >90

Compatibile con sistemi di controllo remoto in caso di utilizzo di lampadine LED dimmerabili
Compatible with remote control systems when dimmable LED bulbs are used

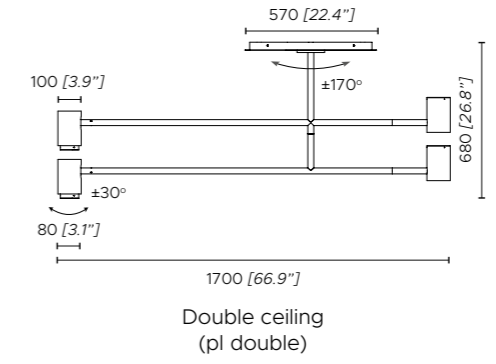
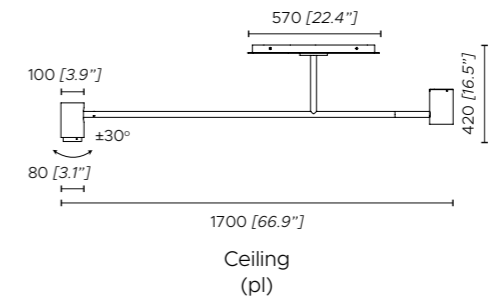

Mikado
Massimiliano Raggi



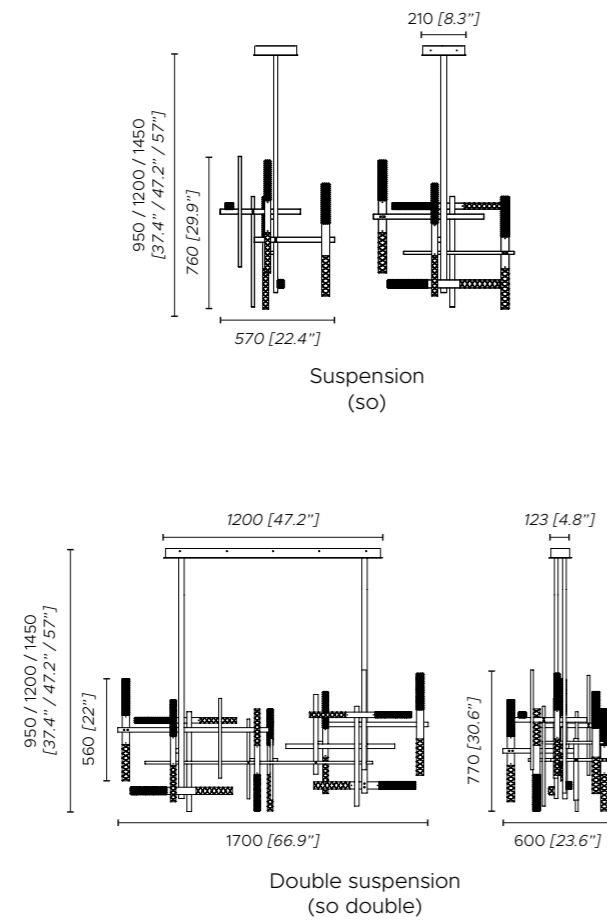

Fonte luminosa - Light source

220 - 240V:

So 10 x 4W LED module; 3000 K; CRI: >90

So double 20 x 4W LED module; 3000 K; CRI: >90

Dimmerazione a taglio di fase/Triac - altri sistemi di dimmerazione (DALI e 1-10V) disponibili su richiesta
Phase cut/Triac dimming - alternative dimming systems (DALI and 1-10V) available on demand

110V:

So 10 x 4W LED module; 3000 K; CRI: >90

So double 20 x 4W LED module; 3000 K; CRI: >90

Dimmerazione a taglio di fase/Triac - dimmerazione 1-10V disponibile su richiesta
Phase cut/Triac dimming - 1-10V dimming system available on demand



1.



3.



2.

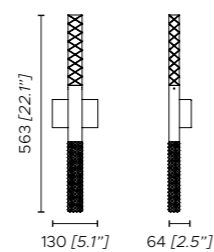

Wall solo/2
(ap solo/2)

- 1. Ottone satinato
- 2. Cristallo trasparente inciso
- 3. Cristallo trasparente prismatico

Fonte luminosa - Light source

220 - 240V:
Ap solo/2 2 x 4W LED module; 3000 K; CRI: >90

Dimmerazione a taglio di fase/Triac - altri sistemi di dimmerazione (DALI e 1-10V) disponibili su richiesta
Phase cut/Triac dimming - alternative dimming systems (DALI and 1-10V) available on demand

- 1. Satin brass
- 2. Transparent engraved crystal diffuser
- 3. Transparent prismatic crystal diffuser

110V:
Ap solo/2 2 x 4W LED module; 3000 K; CRI: >90

Dimmerazione a taglio di fase/Triac - dimmerazione 1-10V disponibile su richiesta
Phase cut/Triac dimming - 1-10V dimming system available on demand

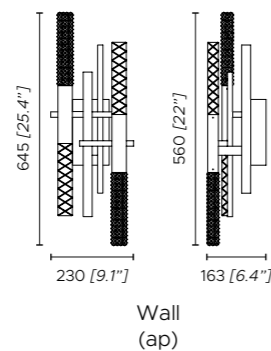

Fonte luminosa - Light source

220 - 240V:
Ap 4 x 4W LED module; 3000 K; CRI: >90

Dimmerazione a taglio di fase/Triac - altri sistemi di dimmerazione (DALI e 1-10V) disponibili su richiesta
Phase cut/Triac dimming - alternative dimming systems (DALI and 1-10V) available on demand

110V:
Ap 4 x 4W LED module; 3000 K; CRI: >90

Dimmerazione a taglio di fase/Triac - dimmerazione 1-10V disponibile su richiesta
Phase cut/Triac dimming - 1-10V dimming system available on demand

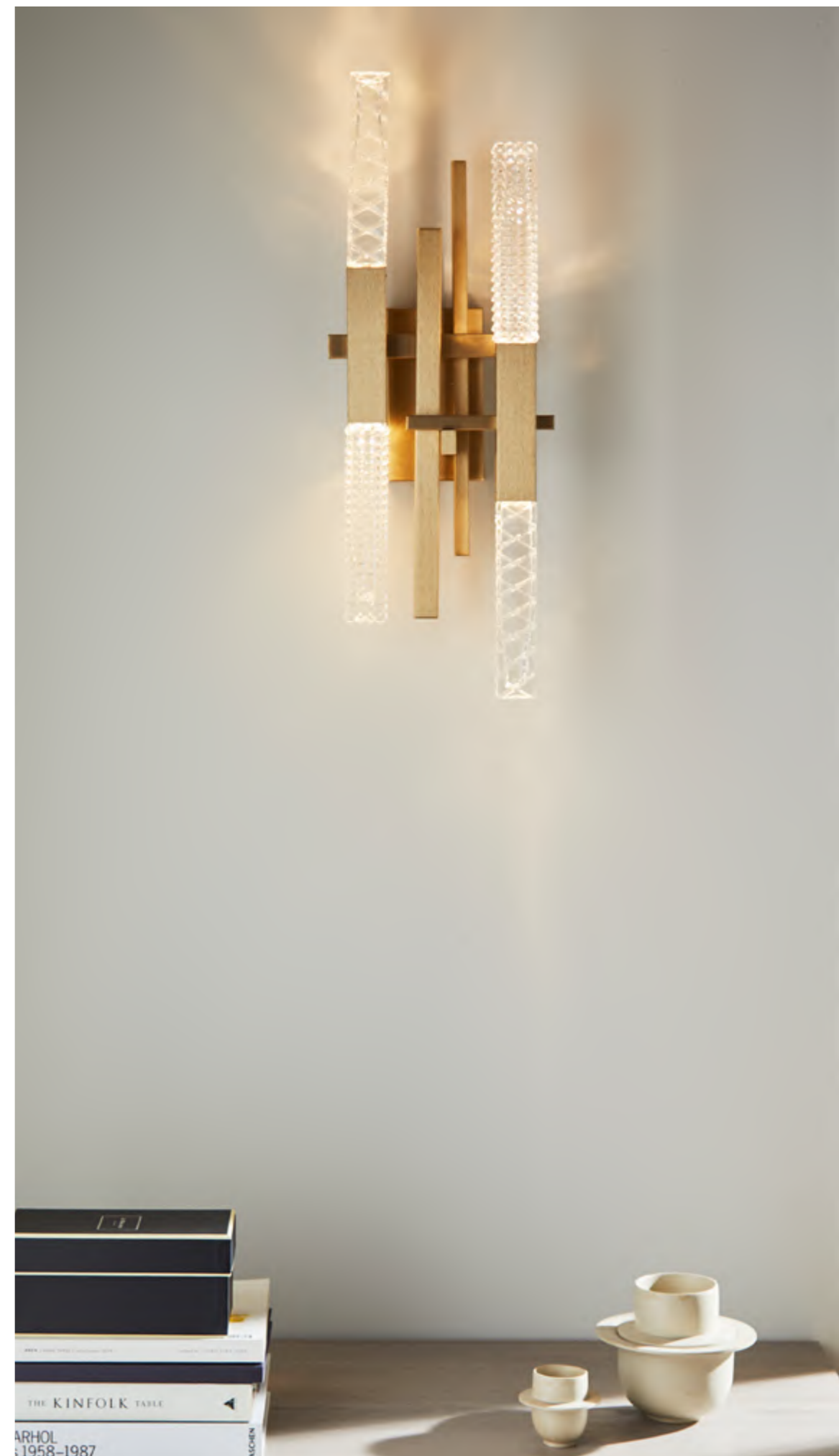

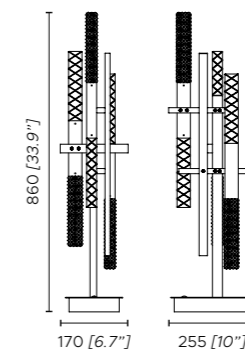

Table
(ta)

Fonte luminosa - Light source

220 - 240V:
Ta 6 x 4W LED module; 3000 K; CRI: >90

110V:
Ta 6 x 4W LED module; 3000 K; CRI: >90

Dimmerabile su base a tre livelli d'intensità (100% - 70% - 30%)
Dimmable with three intensity levels on the base (100% - 70% - 30%)

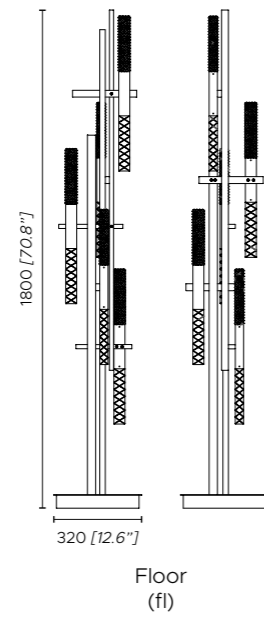

Fonte luminosa - Light source

220 - 240V:
FI 10 x 4W LED module; 3000 K; CRI: >90

110V:
FI 10 x 4W LED module; 3000 K; CRI: >90

Dimmerabile a piede
Dimmable with foot control

Muse Lantern

Tristan Auer





- 1. Struttura bronzo spazzolato
- 2. Maniglia in seta intrecciata color miele
- 3. Diffusore acrilico color ambra

- 1. Satin bronze frame
- 2. Honey-coloured braided silk handle
- 3. Amber acrylic diffuser

Fonte luminosa - Light source

220 - 240V:
1 x 10W E27 Classic Deco LED

110V:
1 x 10W E26 Classic Deco LED

Disponibile su richiesta versione con dimmer a piede, compatibile solo con lampadine LED dimmerabili
Foot dimmer available on demand, compatible with dimmable LED light bulbs only

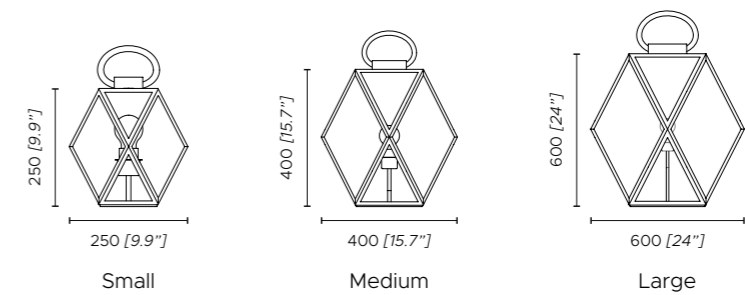

Ongo

Jessica Corr for Tzelan



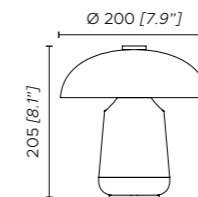

1. Laccato arancione scuro
2. Laccato oro satinato
3. Laccato nickel caldo

1. Dark orange lacquered
2. Satin gold lacquered
3. Warm nickel lacquered

Fonte luminosa - Light source

220 - 240V:
1 x 3.5W LED module; 2800 K; CRI: >90

110V:
1 x 3.5W LED module; 2800 K; CRI: >90

Dimmerabile, due intensità
Dimmable, two intensity levels

Solitario

Marcello Colli & Maurizio Di Mauro





1. Bronzo spazzolato chiaro opaco
 2. Laccato nero seta opaco
 3. Sfera vetro acidato ø 120 / 4.7"
 4. Sfera vetro acidato ø 200 / 7.9"
 5. Lente flood

Fonte luminosa - Light source

220 - 240V:
 Pl - So 1 x 7.5W GU10 LED dimmerabile - *dimnable*;
 3000 K; CRI: >90
 Ap mini 1 x 7W E27 T8 LED
 Ap mini IP44 1 x 5W G9 LED

1. Matt light satin bronze
 2. Matt black silk lacquered
 3. Acid-etched glass sphere ø 120 / 4.7"
 4. Acid-etched glass sphere ø 200 / 7.9"
 5. Flood lens

110V:
 Pl - So 1 x 7.5W GU10 LED dimmerabile - *dimnable*;
 3000 K; CRI: >90
 Ap mini 1 x 7W E26 T8 LED
 Ap mini IP44 1 x 5W G9 LED

Compatibile con sistemi di controllo remoto in caso di utilizzo di lampadine LED dimmerabili
 Compatible with remote control systems when dimmable LED bulbs are used

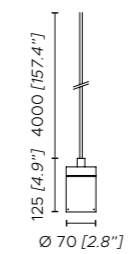

Suspension
 (so)



Composizioni / Compositions

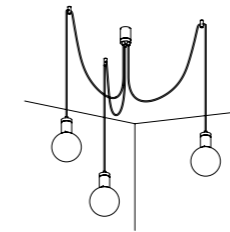

- 1 x Rosone 3x / Canopy 3x
- 3 x Solitario So
- 3 x Kit accessori / Accessories
(Carrucola / Blocca cavo)
(Pulley / Cable clamp)
- 3 x Sfere Ø 200 / Spheres Ø 200 / Ø 7,9"

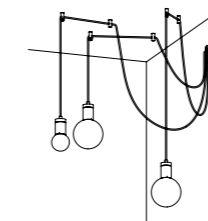

- 1 x Rosone 3x / Canopy 3x
- 3 x Solitario So
- 6 x Kit accessori / Accessories
(Carrucola / Blocca cavo)
(Pulley / Cable clamp)
- 1 x Sfera Ø 120 / Sphere Ø 120 / Ø 4,7"
- 2 x Sfere Ø 200 / Spheres Ø 200 / Ø 7,9"

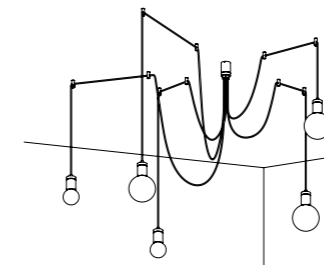

- 1 x Rosone 5x / Canopy 5x
- 5 x Solitario So
- 10 x Kit accessori / Accessories
(Carrucola / Blocca cavo)
(Pulley / Cable clamp)
- 2 x Sfere Ø 120 / Spheres Ø 120 / Ø 4,7"
- 3 x Sfere Ø 200 / Spheres Ø 200 / Ø 7,9"

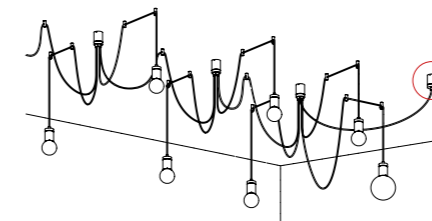

Una sola uscita elettrica per composizioni potenzialmente infinite

Just one electrical output for potentially unlimited compositions

Rosone / Canopy

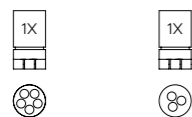

- 1 x rosone 5x / 1 x canopy 5x
- 1 x rosone 3x / 1 x canopy 3x

Sfere / Spheres



- 3 x Ø 200 / 4,7"
- 5 x Ø 120 / 7,8"

8 x Solitario So

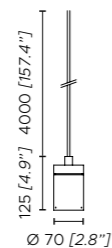

Accessori / Accessories

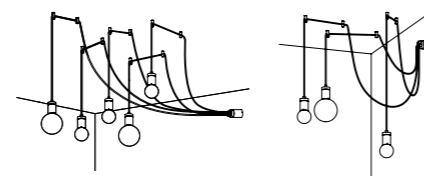
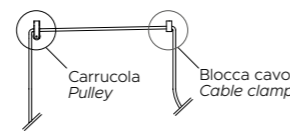

Composizione 5x / Composition 5x

Composizione 3x / Composition 3x

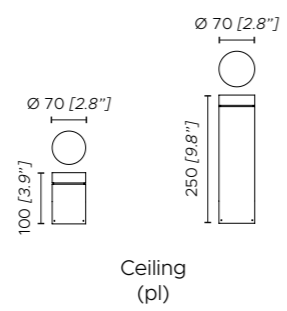

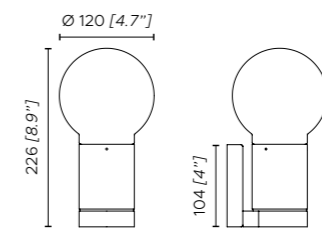

Mini wall/mini IP44 wall
(ap mini/ap mini IP44)

Stardust

Marcello Colli & Maurizio Di Mauro





1. Bronzo spazzolato chiaro opaco

2. Vetro bianco satinato

Fonte luminosa - Light source

220 - 240V:
1 x 14W E27 LED + 20 x 2W LED module;
2700 K; CRI: >90

1. Matt light satin bronze

2. Satin white glass

110V:
1 x 14W E26 LED + 20 x 2W LED module;
2700 K; CRI: >90

Fonte luminosa principale compatibile con sistemi di controllo remoto in caso di utilizzo di lampadine LED dimmerabili
Modulo LED, posizionati sui bracci non sono dimmerabili
Main light source compatible with remote control systems when dimmable LED bulbs are used
LED module located on arms are not dimmable

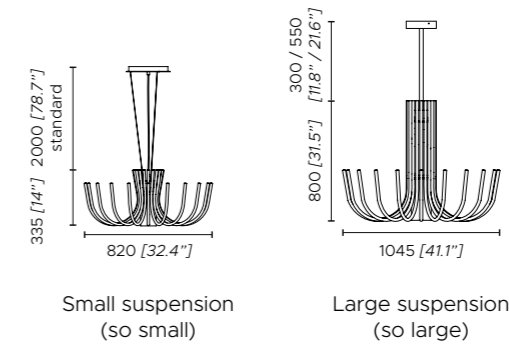
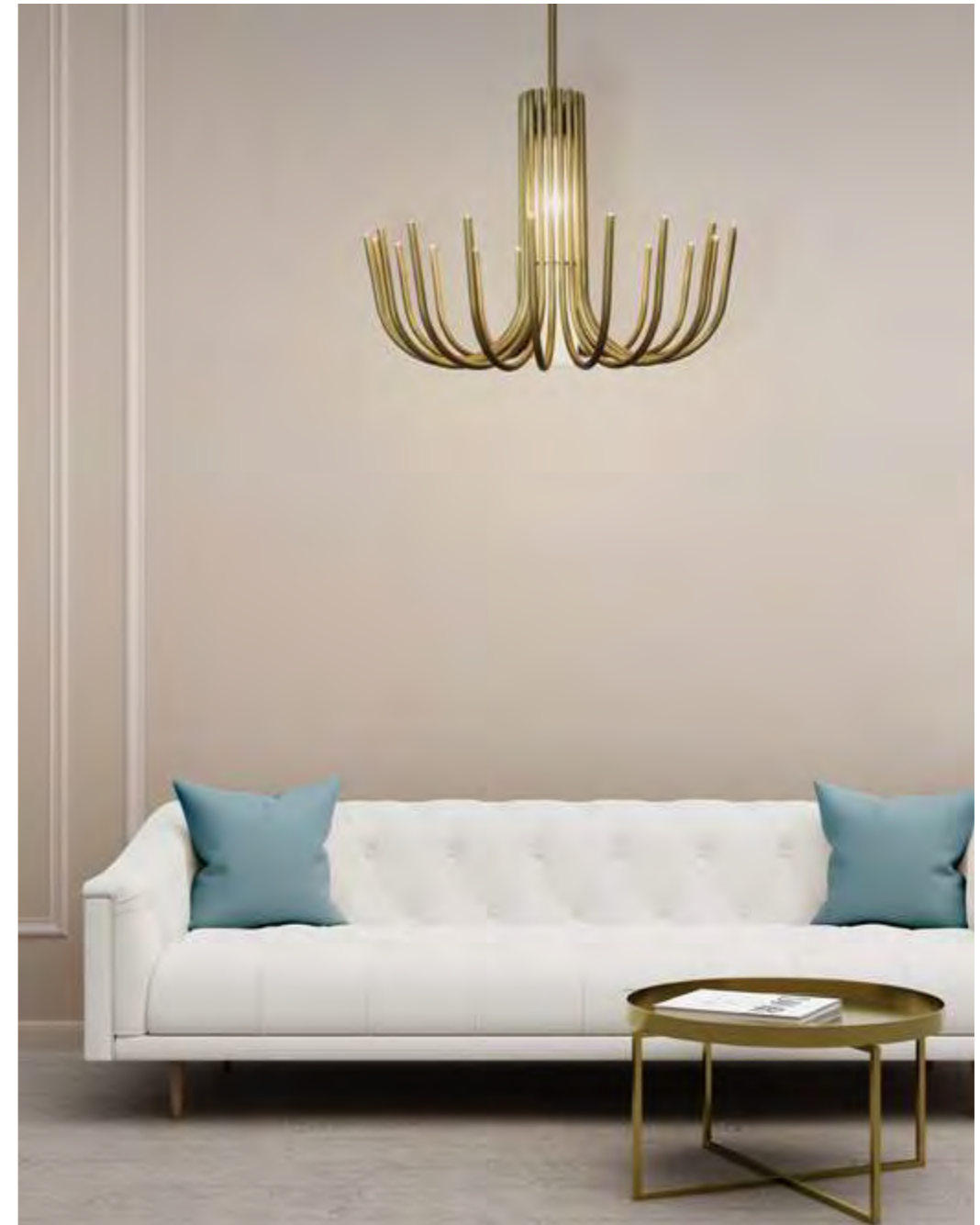

Stick
Studiopepe



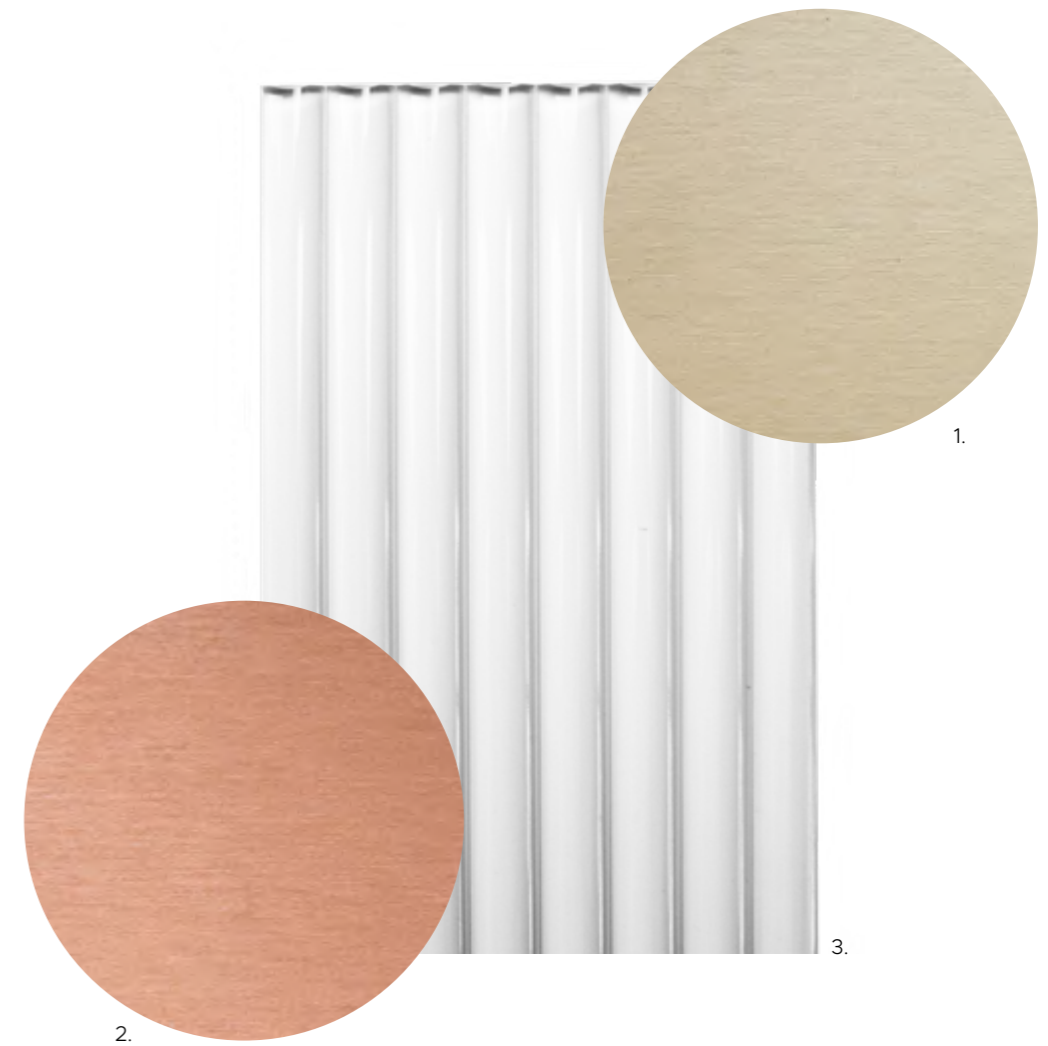
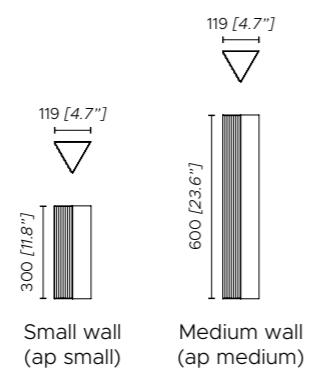

1. Struttura nickel dorato satinato
2. Struttura rame satinato
3. Diffusore plexiglass rigato

Altre finiture disponibili su richiesta

Fonte luminosa - Light source

220 - 240V:
Ap small 1 x 13.5W Custom LED; 2700 K; CRI: >90
Ap medium 1 x 27W Custom LED; 2700 K; CRI: >90

Dimmerazione a taglio di fase/Triac - altri sistemi di dimmerazione (DALI e 1-10V) disponibili su richiesta
Phase cut/Triac dimming - alternative dimming systems (DALI and 1-10V) available on demand

1. Satin golden nickel frame
2. Satin copper frame
3. Striped plexiglass diffuser

Other finishes available on demand

110V:
Ap small 1 x 13.5W Custom LED; 2700 K; CRI: >90
Ap medium 1 x 27W Custom LED; 2700 K; CRI: >90

Dimmerazione a taglio di fase/Triac - dimmerazione 1-10V disponibile su richiesta
Phase cut/Triac dimming - 1-10V dimming system available on demand

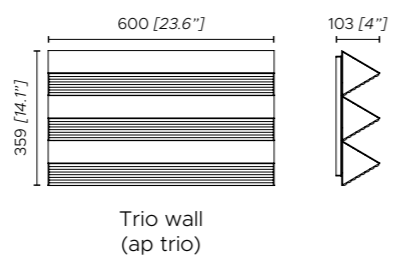

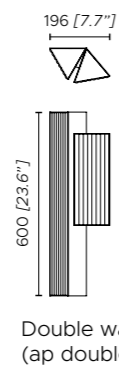

Double wall
(ap double)

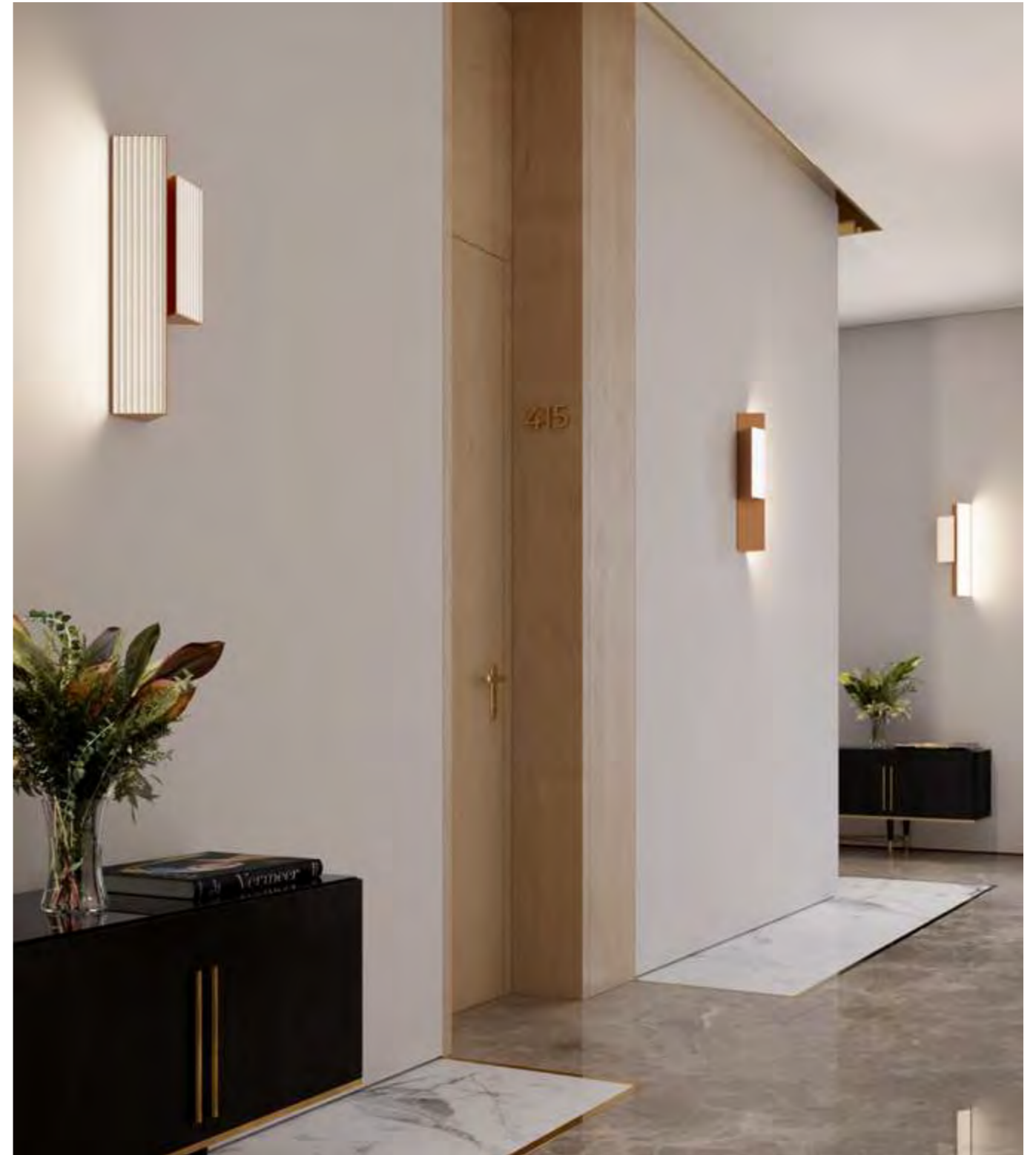

Fonte luminosa - Light source

220 - 240V:

Ap double 1 x 13.5W Custom LED + 1 x 27W Custom LED;
2700 K; CRI: >90

Ap trio 3 x 27W Custom LED; 2700 K; CRI: >90

Dimmerazione a taglio di fase/Triac - altri sistemi
di dimmerazione (DALI e 1-10V) disponibili su richiesta
Phase cut/Triac dimming - alternative dimming systems
(DALI and 1-10V) available on demand

110V:

Ap double 1 x 13.5W Custom LED + 1 x 27W Custom LED;
2700 K; CRI: >90

Ap trio 3 x 27W Custom LED; 2700 K; CRI: >90

Dimmerazione a taglio di fase/Triac - dimmerazione
1-10V disponibile su richiesta
Phase cut/Triac dimming - 1-10V dimming system
available on demand

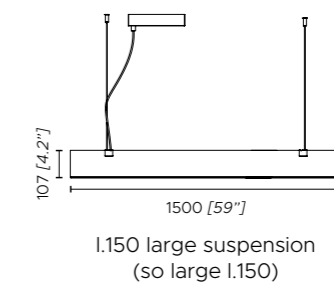
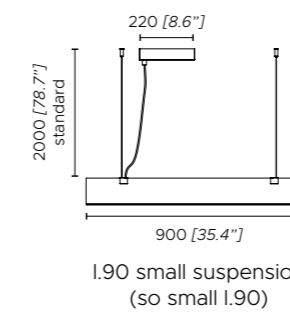

Fonte luminosa - Light source

220 - 240V:
So small I.90 1 x 40W Custom LED; 2700 K; CRI: >90
So large I.150 1 x 65W Custom LED; 2700 K; CRI: >90

Dimmerazione a taglio di fase/Triac - altri sistemi di dimmerazione (DALI e 1-10V) disponibili su richiesta
Phase cut/Triac dimming - alternative dimming systems (DALI and 1-10V) available on demand

110V:
So small I.90 1 x 40W Custom LED; 2700 K; CRI: >90
So large I.150 1 x 65W Custom LED; 2700 K; CRI: >90

Dimmerazione a taglio di fase/Triac - dimmerazione 1-10V disponibile su richiesta
Phase cut/Triac dimming - 1-10V dimming system available on demand

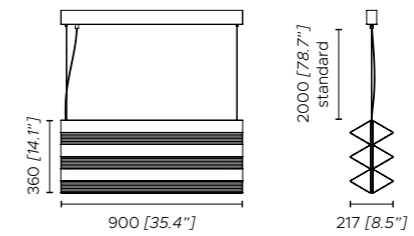

Trio suspension
(so trio)

Fonte luminosa - Light source

220 - 240V:

So trio 6 x 40W Custom LED; 2700 K; CRI: >90

Dimmerazione a taglio di fase/Triac - altri sistemi di dimmerazione (DALI e 1-10V) disponibili su richiesta
Phase cut/Triac dimming - alternative dimming systems (DALI and 1-10V) available on demand

110V:

So trio 6 x 40W Custom LED; 2700 K; CRI: >90

Dimmerazione a taglio di fase/Triac - dimmerazione 1-10V disponibile su richiesta
Phase cut/Triac dimming - 1-10V dimming system available on demand

Tenebra

Jan Van Lierde



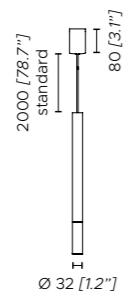

Suspension
(so)

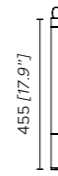

Battery suspension
(so battery)



VERSIONE A BATTERIA,
SENZA ROSONE
**BATTERY OPERATED
VERSION, WITHOUT CANOPY**

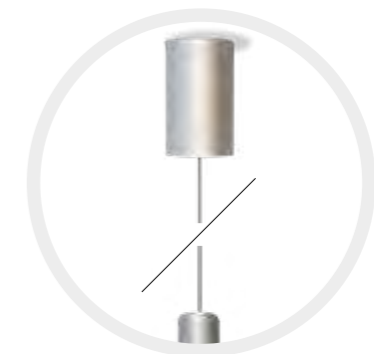

VERSIONE CABLATA,
CON ROSONE
**WIRED VERSION,
WITH CANOPY**

1. Laccato argento
2. Laccato oro rosa
3. Laccato nero opaco

Fonte luminosa - Light source

220 - 240V:
1 x 3W LED module; 2700 K; CRI: >90

IP65

Batteria/battery
Dimmerabile
Dimmable

1. Silver lacquered
2. Rose gold lacquered
3. Matt black lacquered

110V:
1 x 3W LED module; 2700 K; CRI: >90

IP65

ACCESSORI TENEBRA / TENEBRA ACCESSORIES

DIFFUSORI PER VERSIONE CABLATA E A BATTERIA

WIRED & BATTERY OPERATED DIFFUSERS



1.



2.



3.

- 1. Diffusore cristallo sintetico, Venezia ambra
- 2. Diffusore cristallo sintetico, Lente grigio
- 3. Diffusore cristallo sintetico, Crystal Macedonia

- 1. Diffuser synthetic crystal, Venezia Amber
- 2. Diffuser synthetic crystal, Grey lens
- 3. Diffuser synthetic crystal, Crystal Macedonia

ACCESSORI DI FISSAGGIO

PER VERSIONE A BATTERIA (inclusi)

BATTERY OPERATED HANGING ACCESSORIES (included)



Accessori di fissaggio (inclusi)

1 x staffa per attacco a soffitti + 1 x griplock + 1 x bloccacavo + 1 x cavo in acciaio l. 2m + 1 x gancio standard

Hanging accessories (included)

1 x ceiling attachment + 1 x griplock + 1 x screw lock + 1 x steel cable l. 2m + 1 x standard hook

Accessori versione a batteria (non inclusi) / Battery operated version accessories (not included)



ACCESSORI "A" (non inclusi)
1 x cavo in acciaio l. 2m + 1 x gancio design

"A" ACCESSORIES (not included)
1 x steel cable l. 2m + 1 x design hook



ACCESSORI "B" (non inclusi)
1 x tirante + 2 x bloccacavo + 1 x cavo in acciaio l. 10m + 6 x griplock

"B" ACCESSORIES (not included)
1 x tie rod + 2 x screw lock + 1 x steel cable l. 10m + 6 x griplock

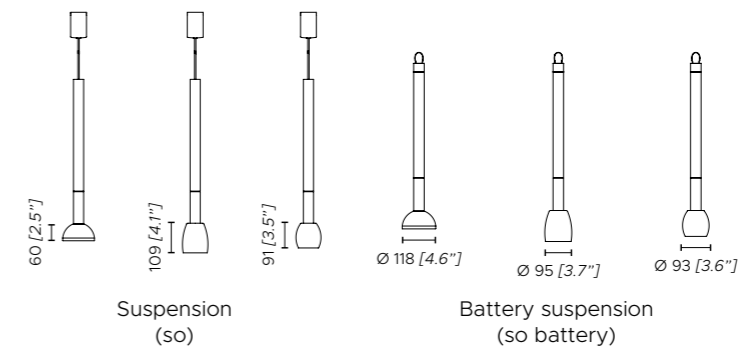

Up

Massimiliano Raggi



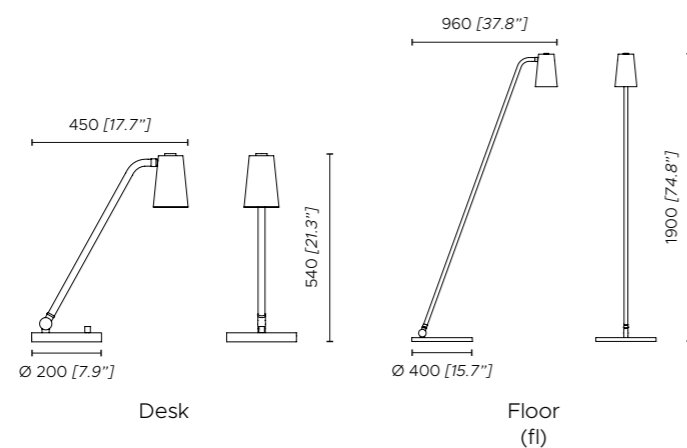

1. Struttura bronzo-nickel spazzolato
2. Cavo in seta color arancione scuro
3. Diffusore esterno: bronzo-nickel spazzolato
4. Diffusore interno: crema lucido

1. Brushed bronze-nickel frame
2. Dark orange silk rope
3. Outside diffuser: brushed bronze-nickel
4. Inside diffuser: polished cream

Fonte luminosa - Light source

220 - 240V:
 Ap 1 x 5W E27 LED
 Desk 1 x 10W E27 LED
 Fl 1 x 14W E27 LED

110V:
 Ap 1 x 5W E26 LED
 Desk 1 x 10W E26 LED
 Fl 1 x 14W E26 LED

Desk - ap
 Interruttore rotativo ON-OFF su base
 Rotary ON-OFF switch on the base

Fl
 Disponibile su richiesta versione con dimmer a piede, compatibile solo con lampadine LED dimmerabili
 Foot dimmer available on demand, compatible with dimmable LED light bulbs only

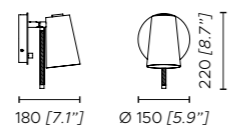

Wall
(ap)

Vegas

Massimiliano Raggi



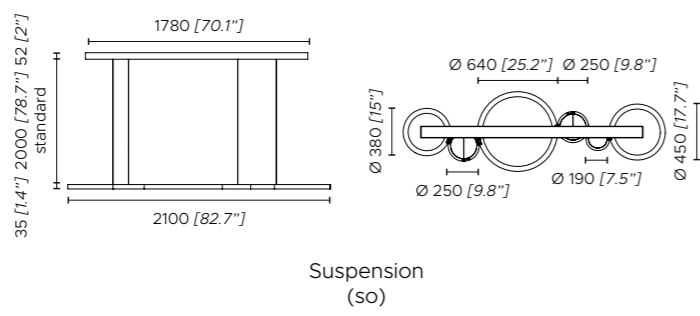

- 1. Rosone bronzo spazzolato
- 2. Anelli grandi in legno bronzo scuro
- 3. Anelli piccoli in legno bronzo chiaro
- 4. Dischi diffusori in alicrite effetto alabastro

- 1. Satin bronze canopy
- 2. Larger rings dark bronze painted wood
- 3. Smaller rings in light bronze painted wood
- 4. Alabaster effect alicrite discs diffusers

Fonte luminosa - Light source

220 - 240V:
 3 x 12W COB LED + 1 x 8W Panel LED
 + 2 x 10W Panel LED; 2700 K; CRI: >90

110V:
 3 x 12W COB LED + 1 x 8W Panel LED
 + 2 x 10W Panel LED; 2700 K; CRI: >90

Dimmerazione a taglio di fase/Triac - altri sistemi di dimmerazione (DALI e 1-10V) disponibili su richiesta
Phase cut/Triac dimming - alternative dimming systems (DALI and 1-10V) available on demand

Dimmerazione a taglio di fase/Triac - dimmerazione 1-10V disponibile su richiesta
Phase cut/Triac dimming - 1-10V dimming system available on demand



**Sartoria
Tailoring**

Athena

Massimiliano Raggi



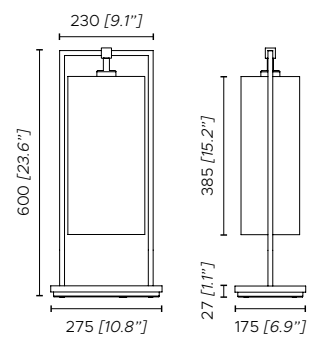

Table
(ta)

Struttura / Frame



1.



2.

1. Nickel lucido / *Polished nickel*
2. Rovere tinto marrone scuro / *Dark brown stained oak*

Paralume / Shade



1.

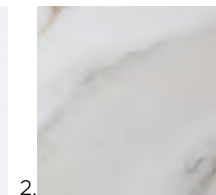

2.

1. Cotone bianco / *White cotton*
2. Tessuto effetto marmo bianco Calacatta / *White Calacatta marble printed fabric*

Fonte luminosa - Light source

220 - 240V:
1 x 13W E27 LED

110V:
1 x 13W E26 LED

Disponibile su richiesta versione con dimmer su cavo, compatibile solo con lampadine LED dimmerabili
Dimmer switch on the cable available on demand, compatible with dimmable LED light bulbs only

Circus & Circus led

Contardi Studio





Struttura / Frame



Laccato bianco / White lacquered

Paralume / Shade

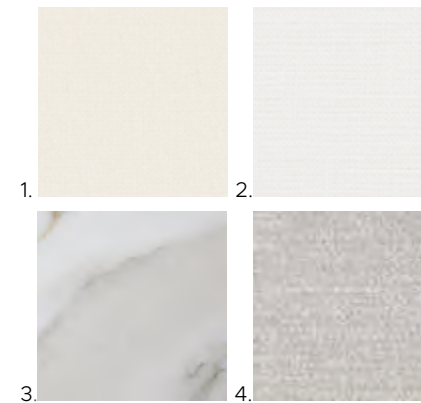

1. Cotone bianco / White cotton
2. Lino bianco / White linen
3. Tessuto effetto marmo bianco Calacatta / White Calacatta marble printed fabric
4. Bouclé color sabbia / Sand colour bouclé

*Altri tessuti sono disponibili su richiesta
Other fabrics available on demand*

Passamaneria opzionale / Optional trim



- | | |
|-------------------------|--------------------------|
| 1. Senape / Mustard | 1. Blu scuro / Dark blue |
| 2. Rosso / Red | 2. Grigio / Grey |
| 3. Azzurro / Light blue | 6. Nero / Black |

*Altri colori di passamanerie sono disponibili su richiesta
Other trim colours available on demand*

Fonte luminosa Circus - Circus light source

220 - 240V:

50 - 75 3 x 14W E27 LED
90 - 120 - 150 4 x 14W E27 LED

110V:

50-75 3 x 14W E26 LED
90 - 120 - 150 4 x 14W E26 LED

Compatibile con sistemi di controllo remoto in caso di utilizzo di lampadine LED dimmerabili
Compatible with remote control systems when dimmable LED bulbs are used

Fonte luminosa Circus LED - Circus LED light source

220 - 240V:

50 - 75 1 x 53W LED custom board;
3000 K; CRI: >90
90 - 120 - 150 1 x 70W LED custom board;
3000 K; CRI: >90

Dimmerazione a taglio di fase/Triac - altri sistemi di dimmerazione (DALI e 1-10V) disponibili su richiesta
Phase cut/Triac dimming - alternative dimming systems (DALI and 1-10V) available on demand

110V:

50 - 75 1 x 53W LED custom board;
3000 K; CRI: >90
90 - 120 - 150 1 x 70W LED custom board;
3000 K; CRI: >90

Dimmerazione a taglio di fase/Triac - dimmerazione 1-10V disponibile su richiesta
Phase cut/Triac dimming - 1-10V dimming system available on demand

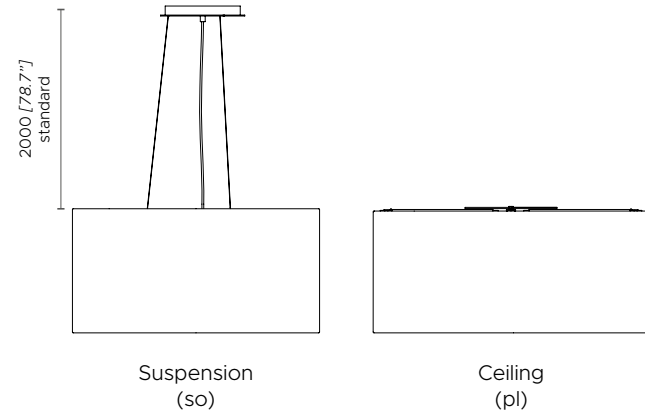

Circus

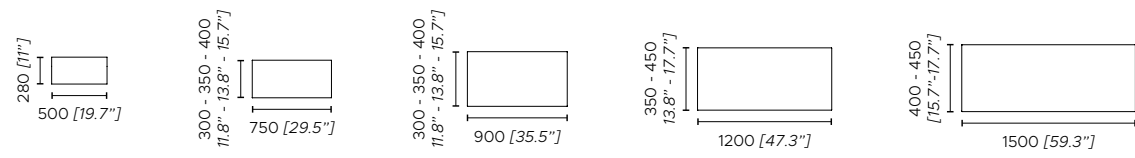

Circus LED

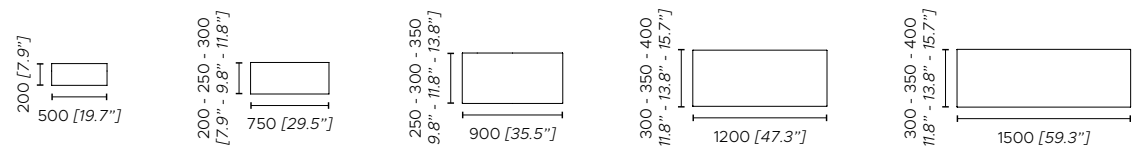

Coco Mega & Deluxe

Coco Mega: Tristan Auer

Coco Deluxe: Tristan Auer & Frédéric Sicard



Struttura / Frame



1. Nickel lucido / Polished nickel

Paralume / Shade

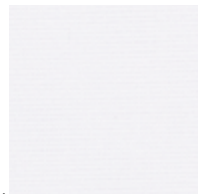

1. Cotone bianco / White cotton
 2. Tessuto effetto marmo bianco Calacatta / White Calacatta marble printed fabric

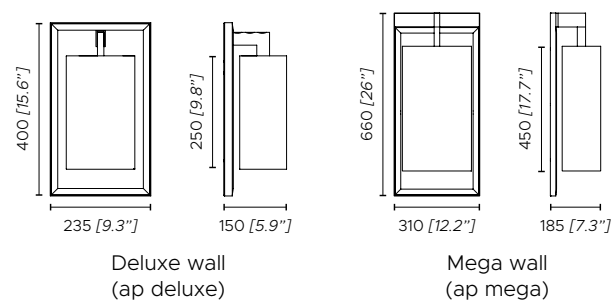
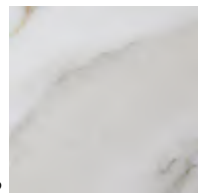

Fonte luminosa - light source

220 - 240V:

Mega ap - ta 1 x 14W E27 LED
 Deluxe ap - ta 1 x 10W E27 LED

110V:

Mega ap - ta 1 x 14W E26 LED
 Deluxe ap - ta 1 x 10W E26 LED

Mega ap - Deluxe ap

Compatibile con sistemi di controllo remoto in caso di utilizzo di lampadine LED dimmerabili
 Compatible with remote control systems when dimmable LED bulbs are used

Mega ta - Deluxe ta

Disponibile su richiesta versione con dimmer su cavo, compatibile solo con lampadine LED dimmerabili
 Dimmer switch on the cable available on demand, compatible with dimmable LED light bulbs only

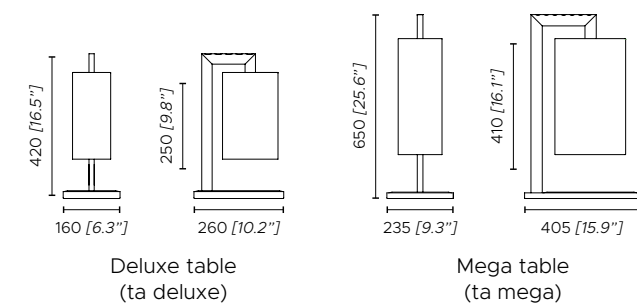



Coco & Coconette

Tristan Auer & Frédéric Sicard

Struttura / Frame

1.



2.

Coco - Coco mini IP441. Nickel lucido / *Polished nickel***Coconette**2. Bronzo spazzolato chiaro opaco / *Matt light satin bronze***Paralume / Shade**

1.



2.



3.

Coco - Coconette1. Cotone bianco / *White cotton*2. Tessuto effetto marmo bianco Calacatta /
*White Calacatta marble printed fabric***Coco mini IP44**3. Tessuto impermeabile bianco / *Waterproof white fabric*

Coconette



Coco

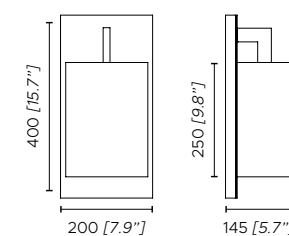

Coconette

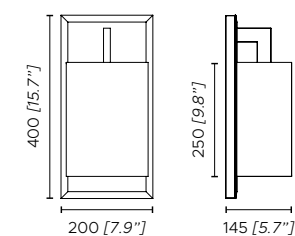

Coco

Fonte luminosa - light source**220 - 240V:**Coco - Coconette 1 x 10W E27 LED
Coco mini IP44 1 x 9W G9 LED**110V:**Coco - Coconette 1 x 10W E26 LED
Coco mini IP44 1 x 9W G9 LEDCompatibile con sistemi di controllo remoto in caso di utilizzo di lampadine LED dimmerabili
Compatible with remote control systems when dimmable LED bulbs are used

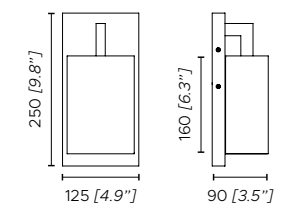

Coco mini IP44



Ovale

Contardi Studio



Table
(ta)

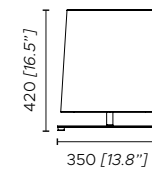

Small table
(ta small)



Struttura / Frame



1.



2.

1. Bronzo spazzolato chiaro opaco / *Matt light satin bronze*
 2. Laccato nero seta opaco / *Matt black silk lacquered*

Paralume / Shade



1.



2.

1. Cotone bianco / *White cotton*
 2. Tessuto effetto marmo bianco Calacatta /
White Calacatta marble printed fabric

① *Passamanerie disponibili su richiesta*
Trims available on demand

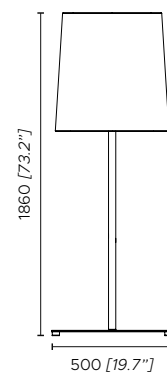

Floor
(f)

Fonte luminosa - Light source

220 - 240V:
 Ta small 1 x 10W E27 LED
 Ta 1 x 13W E27 LED
 FI x 14W E27 LED

110V:
 Ta small 1 x 10W E26 LED
 Ta 1 x 13W E26 LED
 FI x 14W E26 LED

Ta - ta small

Disponibile su richiesta versione con dimmer su cavo, compatibile solo con lampadine LED dimmerabili
Dimmer switch on the cable available on demand, compatible with dimmable LED light bulbs only

FI

Disponibile su richiesta versione con dimmer a piede, compatibile solo con lampadine LED dimmerabili
Foot dimmer available on demand, compatible with dimmable LED light bulbs only





Ap

Ap led

Struttura / Frame



1.



2.

- 1. Bronzo spazzolato chiaro opaco / *Matt light satin bronze*
- 2. Laccato nero seta opaco / *Matt black silk lacquered*

Paralume / Shade



1.



2.

- 1. Cotone bianco / *White cotton*
- 2. Tessuto effetto marmo bianco Calacatta / *White Calacatta marble printed fabric*

 *Passamanerie disponibili su richiesta*
Trims available on demand

Fonte luminosa - Light source

220 - 240V:

- Ap - ta 1 x 10W E27 LED
- Ap LED 1 x 10W E27 LED +
1 x 3W LED module; 2700 K; CRI: >90
- Ta desk 1 x 12W E27 LED
- FI - liseuse x 14W E27 LED

110V:

- Ap - ta 1 x 10W E26 LED
- Ap LED 1 x 10W E26 LED +
1 x 3W LED module; 2700 K; CRI: >90
- Ta desk 1 x 12W E26 LED
- FI - liseuse x 14W E26 LED

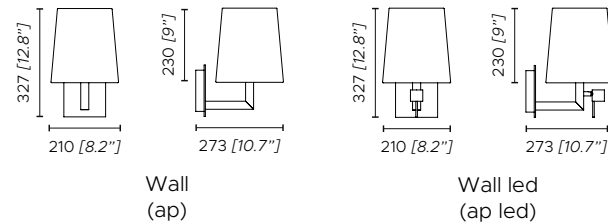

Ap

Compatibile con sistemi di controllo remoto in caso di utilizzo di lampadine LED dimmerabili
Compatible with remote control systems when dimmable LED bulbs are used

Ta - ta desk

Disponibile su richiesta versione con dimmer su cavo, compatibile solo con lampadine LED dimmerabili
Dimmer switch on the cable available on demand, compatible with dimmable LED light bulbs only

FI - liseuse

Disponibile su richiesta versione con dimmer a piede, compatibile solo con lampadine LED dimmerabili
Foot dimmer available on demand, compatible with dimmable LED light bulbs only

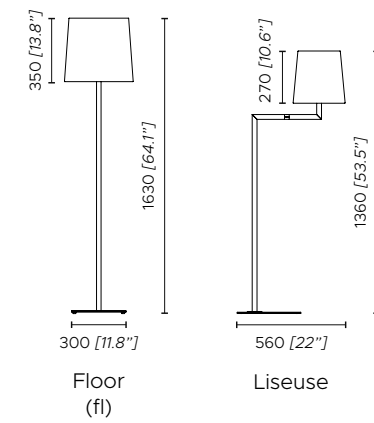
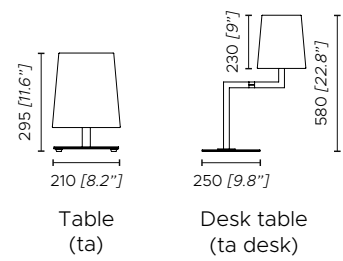
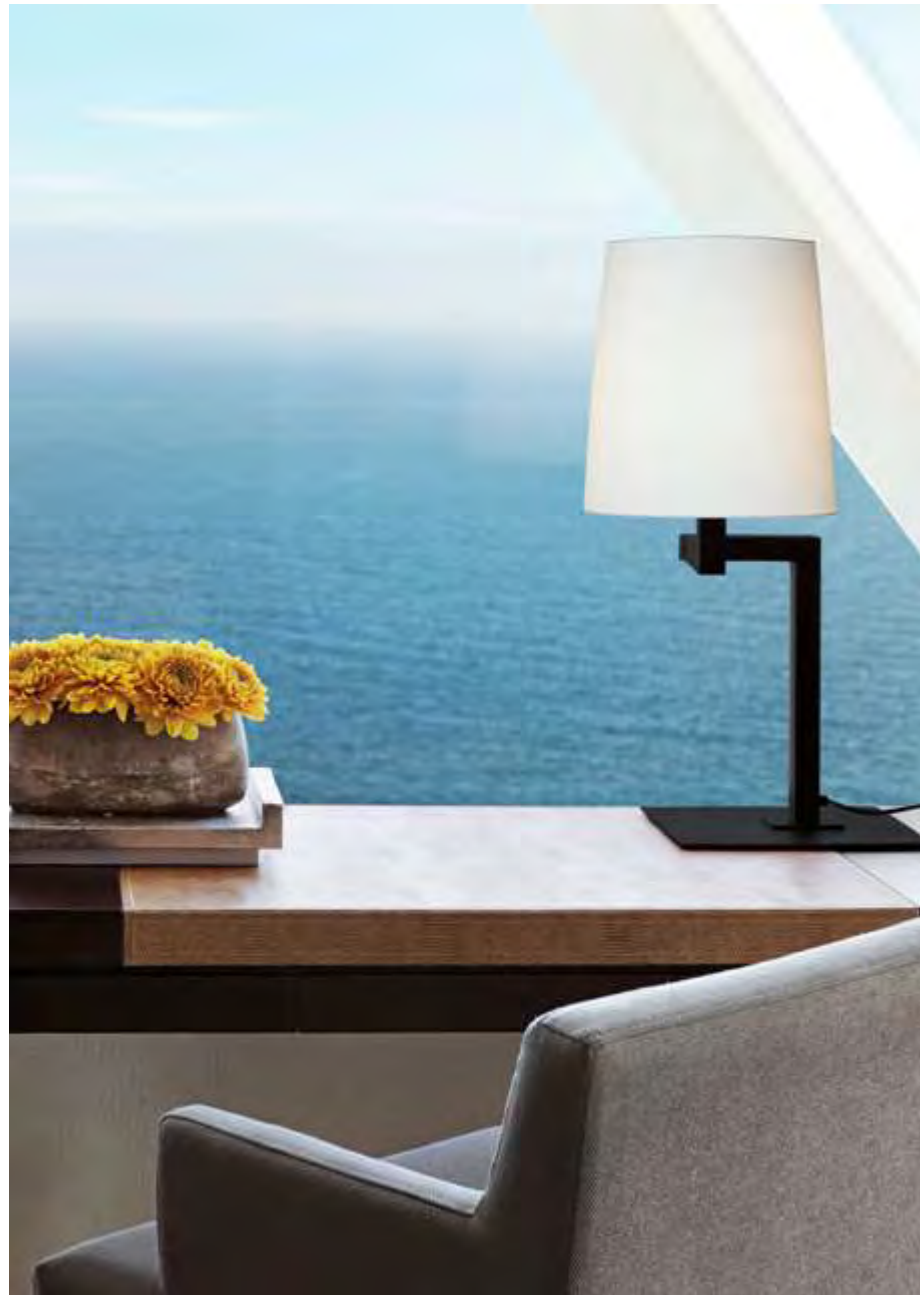

 contardi

outdoor



BLENDING
TECHNOLOGY
& CREATIVE
DESIGN



1. Lo stile incontra la sostanza *Timeless design created in Italy*

La nostra Collezione Outdoor è un chiaro esempio di questa combinazione ideale: un modo per portare all'esterno il mondo indoor, mantenendo le stesse caratteristiche decorative e di qualità del prodotto per interni, senza dimenticare l'aspetto pragmatico relativo alla destinazione d'uso. L'utilizzo di materiali e tessuti decorativi di alta qualità è combinato con finiture e caratteristiche richieste dai più alti standard, tra cui la certificazione IP65 e il trattamento di cataforesi "Marine Grade".

We at Contardi interpret the outdoor collection as a way to bring the interior design to the open-air. The idea is to keep the same decorative and qualitative characteristics of the indoor products without forgetting the pragmatic aspect, specifically the intended use. The use of high-quality decorative materials and fabrics is successfully combined with finishes and regulations required for the highest standards, such as the IP65 and the "Marine Grade".

B

6 **BABU**

C

14 **CALYBABU**
18 **CALYPSO OUTDOOR** so, fl
34 **COCO OUTDOOR**
38 **CUBE OUTDOOR** wired, battery

F

44 **FREEDOM** wired, battery

L

50 **LAGOON**

M

56 **MUSE LANTERN OUTDOOR** so, wired, battery
64 **MUSE OUTDOOR** so, wired, battery

T

72 **TENEBRA** wired, battery

Lampada a parete
Wall lamp

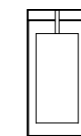

Coco Outdoor
34



Freedom
44

Lampada a sospensione
Suspension lamp



Calypso Outdoor
18



Muse Lantern Outdoor
56



Muse Outdoor
64



Tenebra
72

Lampada da terra & pouf
Floor lamp & pouf



Babu
6



Calypso Outdoor
18



Cube Outdoor
38



Freedom
44

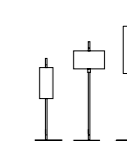

Lagoon
50



Muse Lantern Outdoor
56



Muse Outdoor
64



Calypso
14

Lampada da tavolo
Table lamp



Freedom
44



Muse Lantern Outdoor
56



Muse Outdoor
64

Lampada a batteria
Battery lamp



Cube Outdoor
38



Freedom
44



Muse Lantern Outdoor
56



Muse Outdoor
64



Tenebra
72

Babu

Massimiliano Raggi





1. Acciaio laccato effetto champagne, trattamento cataforesi Marine Grade

2. Stampa Textile digitale 3D su tessuto
3. Stampa Tribal digitale 3D su tessuto

4. Passamaneria in velluto outdoor senape
5. Passamaneria in velluto outdoor arancio
6. Passamaneria in velluto outdoor blu avio

Stampa digitale 3D su tessuto personalizzabile su richiesta

Fonte luminosa - Light source

220 - 240V:
Small 1 x 17W Strip LED; 3000 K; CRI: >90
Medium 1 x 24W Strip LED; 3000 K; CRI: >90
Large 1 x 34W Strip LED; 3000 K; CRI: >90

IP65

1. Champagne lacquered steel, Marine Grade with cataphoresis treatment

2. 3D digital Textile printing on fabric
3. 3D digital Tribal printing on fabric

4. Mustard colour velvet trim for outdoor use
5. Orange colour velvet trim for outdoor use
6. Aviation blue colour velvet trim for outdoor use

3D digital printing fabric customizable fabric on demand

110V:
Small 1 x 17W Strip LED; 3000 K; CRI: >90
Medium 1 x 24W Strip LED; 3000 K; CRI: >90
Large 1 x 34W Strip LED; 3000 K; CRI: >90

IP65

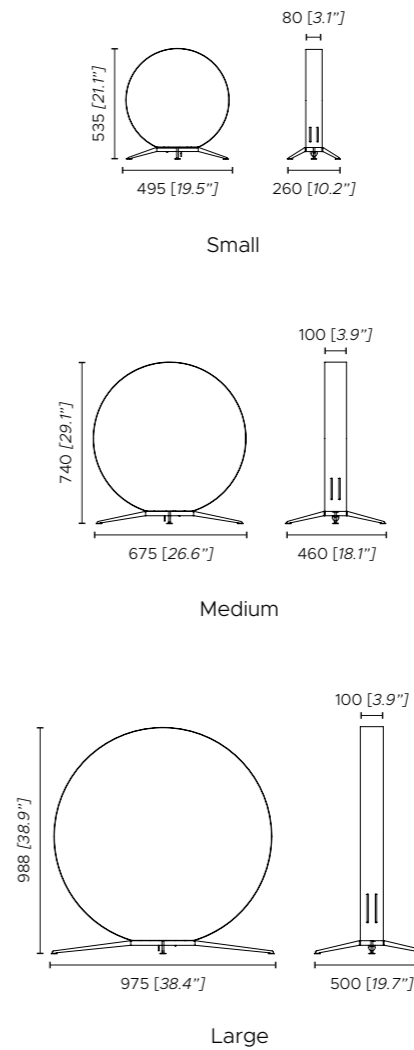

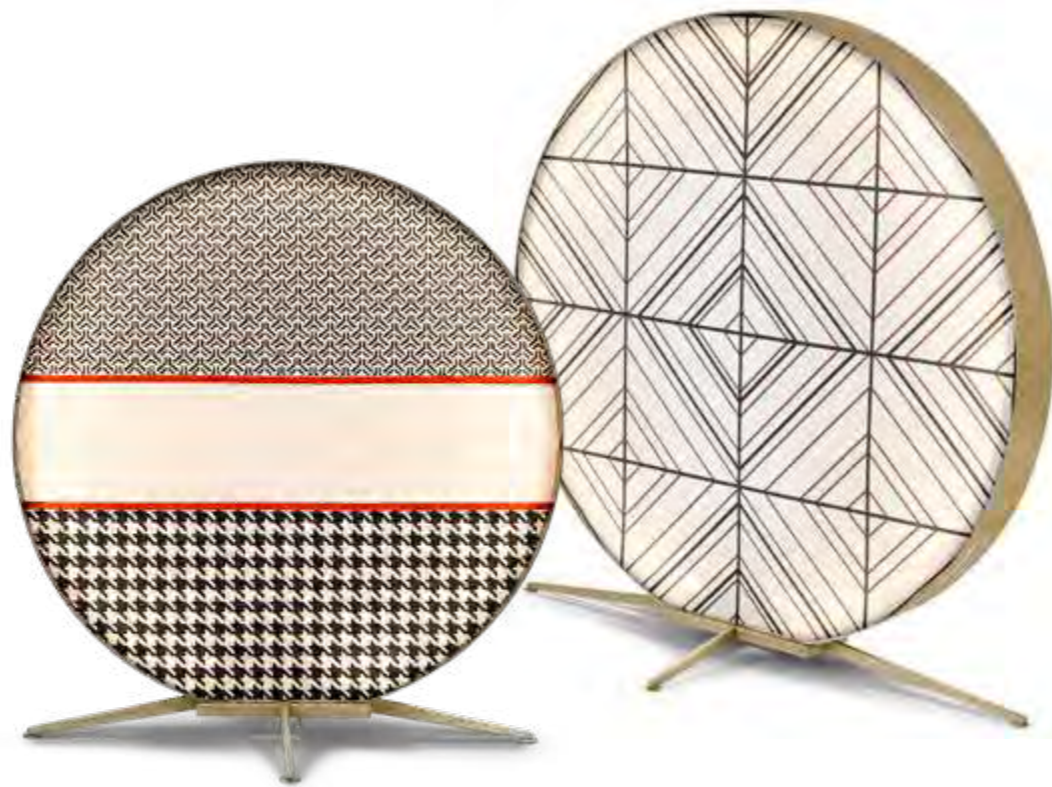

STAMPA 3D **TEXTILE & TRIBAL**
3D PRINT **TEXTILE & TRIBAL**



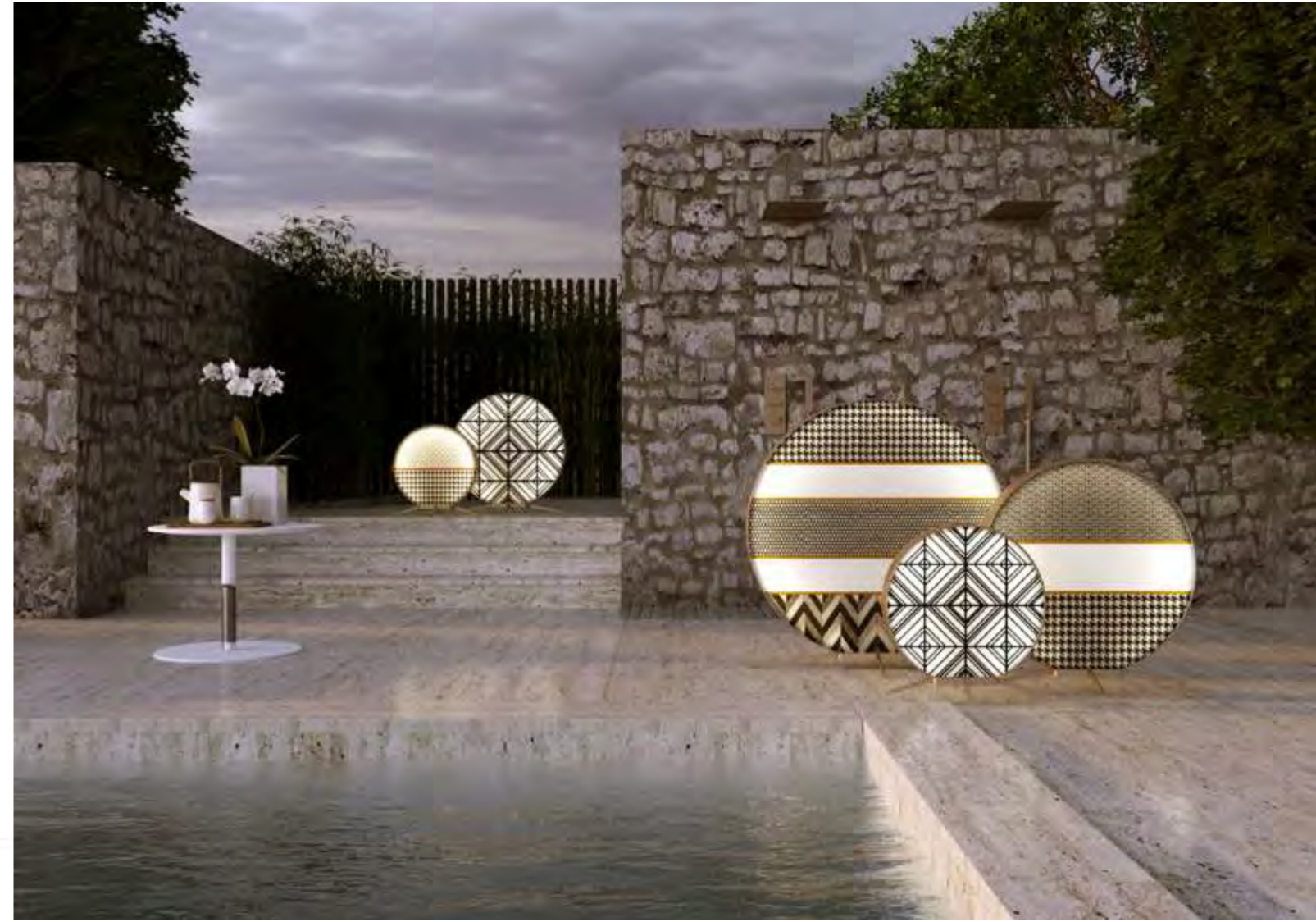
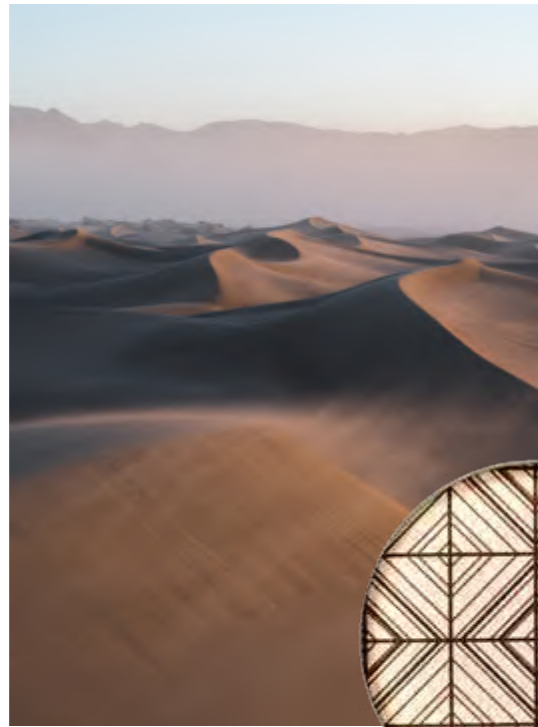

Calybabu

Massimiliano Raggi



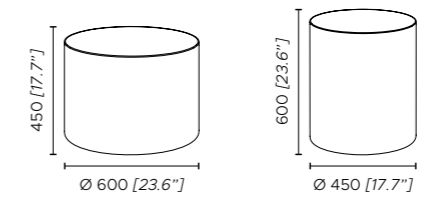
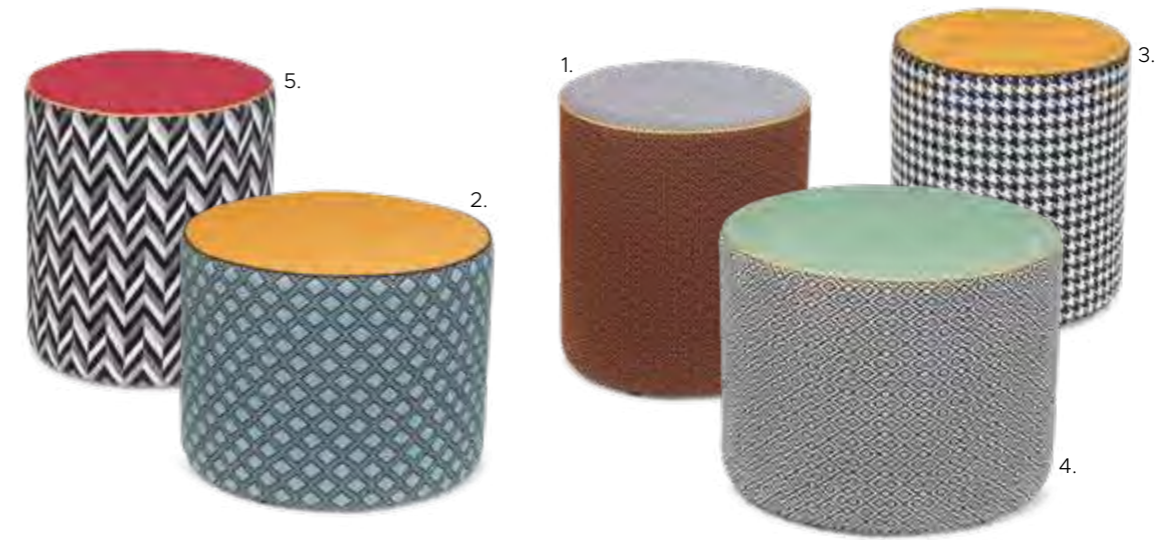

1. Pattern H
2. Pattern I
3. Pattern L

4. Pattern M
5. Pattern N

Calypso outdoor

Servomuto





1. Struttura ottone satinato
2. Corda da marina impermeabile intrecciata in tinta verde
3. **Paralume so:** Antigua, Guadaloupe, Martinique
4. Diffusore vetro trasparente

Fonte luminosa - Light source

220 - 240V:
1 x 9W E27 T8 Tubular LED

IP65

1. Satin brass frame
2. Green waterproof braided rope
3. **So shade:** Antigua, Guadaloupe, Martinique
4. Transparent glass diffuser

110V:
1 x 9W E26 T8 Tubular LED

IP65

Compatibile con sistemi di controllo remoto in caso di utilizzo di lampadine LED dimmerabili
Compatible with remote control systems when dimmable LED bulbs are used



CALYPSO SO



Antigua
Mint



Guadeloupe
Mint



Martinique
Yellow



Antigua
Black



Guadeloupe
Black



Martinique
Black



Antigua
Sale & Pepe



Guadeloupe
Sale & Pepe



Martinique
Building

1900 [74.8"] 95 [3.7"]
standard

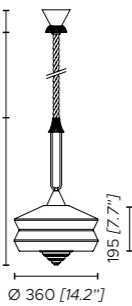

Antigua

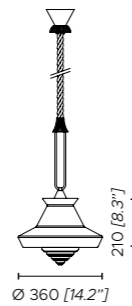

Guadeloupe

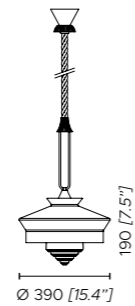

Martinique





CALYPSO SO XL



Antigua
Mint



Guadaloupe
Sale & Pepe



Martinique
Yellow

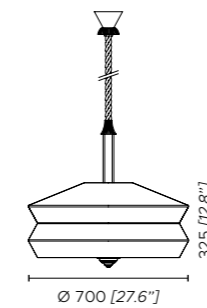

Antigua

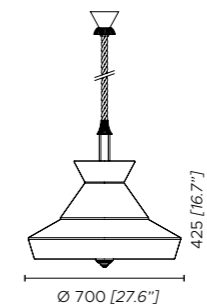

Guadaloupe

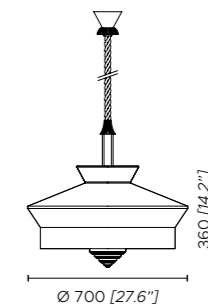

Martinique

Fonte luminosa - Light source

220 - 240V:
1 x 9W E27 T8 Tubular LED

IP65

110V:
1 x 9W E26 T8 Tubular LED

IP65

Compatibile con sistemi di controllo remoto in caso di utilizzo di lampadine LED dimmerabili
Compatible with remote control systems when dimmable LED bulbs are used



CALYPSO
**FLOOR
OUTDOOR**
Servomuto



GEOMETRIC
PATTERNS
& BRIGHT
COLOURS

TRAME GEOMETRICHE & COLORI BRILLANTI

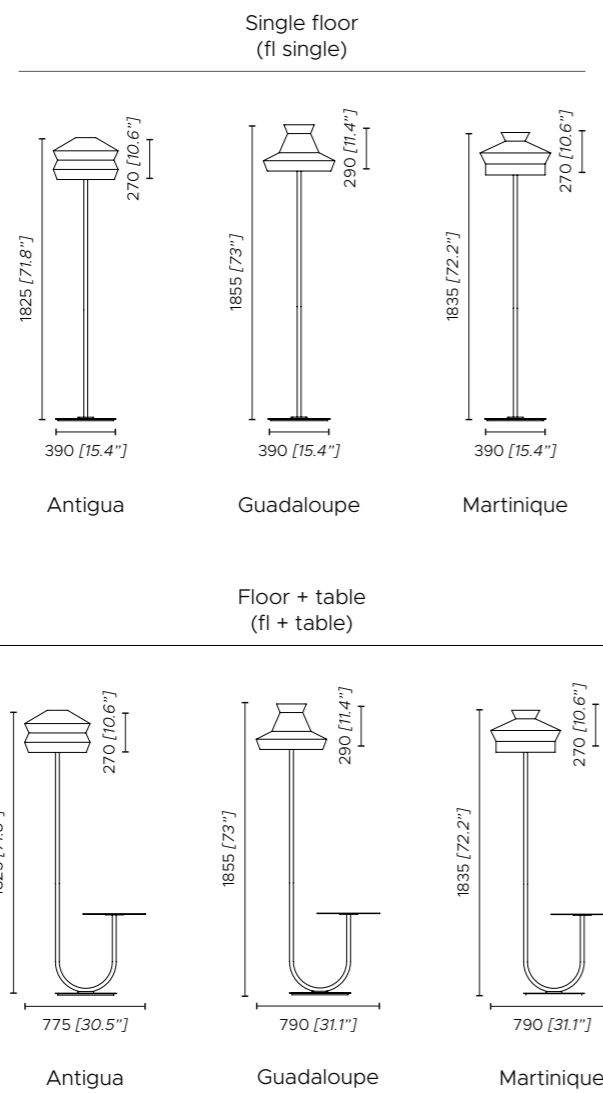

- 1. Laccato nero opaco
- 2. Laccato verde reseda

3. **Paralume fl:** Antigua, Guadaloupe, Martinique

Fonte luminosa - Light source

220 - 240V:
1 x 9W E27 T8 Tubular LED

IP65

- 1. Matt black lacquered
- 2. Reseda green lacquered

3. **Fl shade:** Antigua, Guadaloupe, Martinique

110V:
1 x 9W E26 T8 Tubular LED

IP65

Compatibile con sistemi di controllo remoto in caso di utilizzo di lampadine LED dimmerabili
Compatible with remote control systems when dimmable LED bulbs are used



Coco outdoor

Tristan Auer



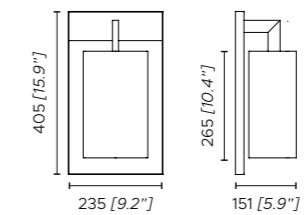

Small

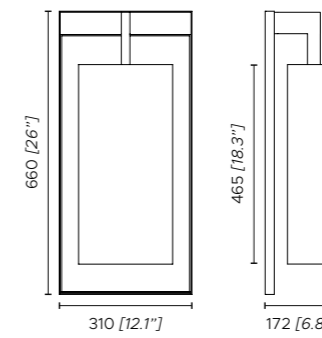

Mega

- 1. Acciaio spazzolato
- 2. Resina effetto legno marino moca scuro con trattamento impermeabilizzante
- 3. Tessuto impermeabile Sale & Pepe

Fonte luminosa - Light source

220 - 240V:
 Small 1 x 10W E27 LED
 Mega 1 x 14W E27 LED

IP65

- 1. Satin steel
- 2. Dark mocha marine wood effect resin with waterproof treatment
- 3. Sale & Pepe waterproof fabric

110V:
 Small 1 x 10W E26 LED
 Mega 1 x 14W E26 LED

IP65

Compatibile con sistemi di controllo remoto in caso di utilizzo di lampadine LED dimmerabili
 Compatible with remote control systems when dimmable LED bulbs are used



Cube outdoor

Massimiliano Raggi

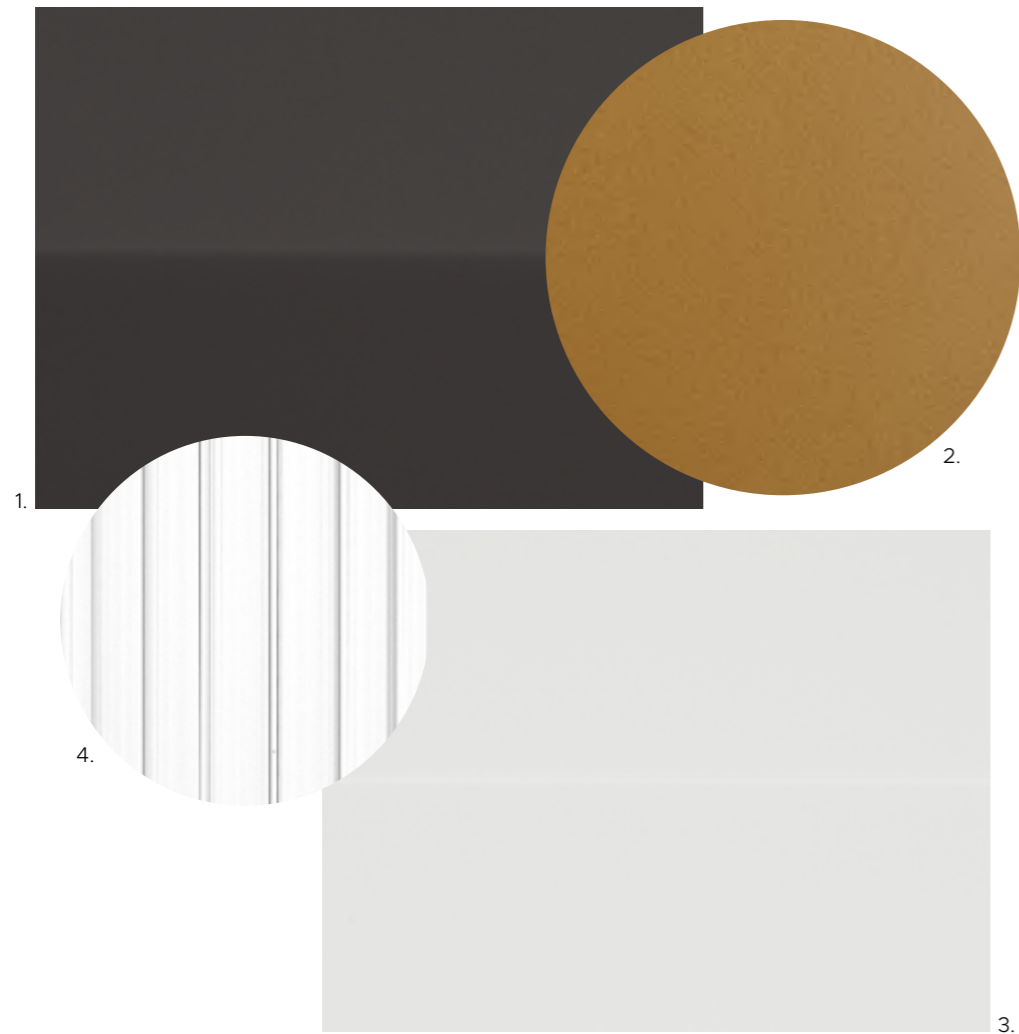

- 1. Esterno: bronzo scuro
- 2. Interno: laccato oro, trattamento cataforesi Marine Grade
- 3. Laccato bianco opaco, trattamento cataforesi Marine Grade
- 4. Diffusore plexiglass rigato

- 1. Outside: dark bronze
- 2. Inside: gold lacquered, Marine Grade with cataphoresis treatment
- 3. Matt white lacquered, Marine Grade with cataphoresis treatment
- 4. Striped plexiglass diffuser

Fonte luminosa - Light source

220 - 240V:
Cablata/wired 1 x 10W E27 LED
Batteria/battery 1 x 4W LED module; 2700 K; CRI: >90

IP65

110V:
Cablata/wired 1 x 10W E26 LED
Batteria/battery 1 x 4W LED module; 2700 K; CRI: >90

IP65

Cablata/wired

Compatibile con sistemi di controllo remoto in caso di utilizzo di lampadine LED dimmerabili
 Compatible with remote control systems when dimmable LED bulbs are used



Cablata / Wired

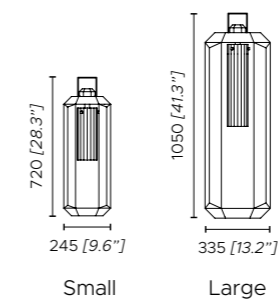

Batteria / Battery

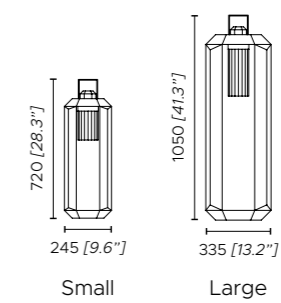



VERSIONE A **BATTERIA**
BATTERY OPERATED VERSION



ACCENSIONE / SPEGNIMENTO
ON / OFF SWITCHING

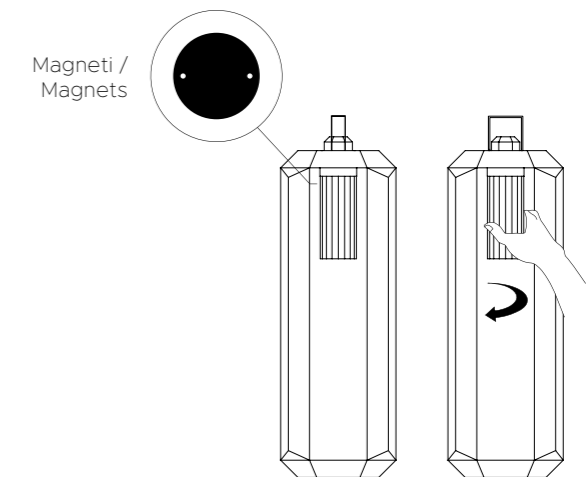

Freedom

Massimiliano Raggi



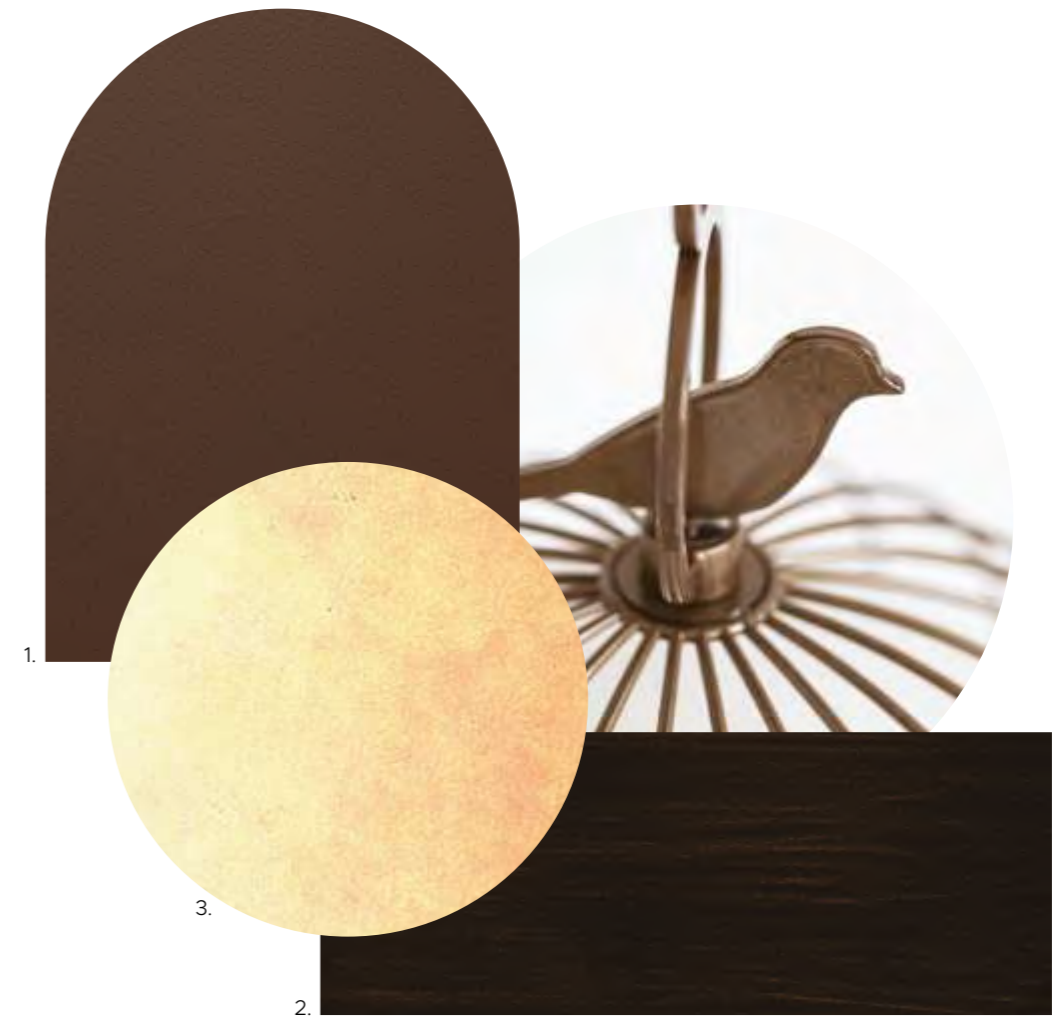

1. Gabbia in metallo verniciato bronzo
2. Base in legno marino marrone scuro con trattamento cataforesi
3. Diffusore vetroresina crema

Fonte luminosa - Light source

220 - 240V:
Cablata/wired 1 x 10W E27 LED
Batteria/battery 1 x 3W LED module; 2700 K; CRI: >90

IP65

Cablata/wired

Compatibile con sistemi di controllo remoto in caso di utilizzo di lampadine LED dimmerabili
 Compatible with remote control systems when dimmable LED bulbs are used

1. Cage in bronze lacquered metal
2. Dark brown marine wood with waterproof treatment for the base
3. Cream-coloured fiberglass diffuser

110V:
Cablata/wired 1 x 10W E26 LED
Batteria/battery 1 x 3W LED module; 2700 K; CRI: >90

IP65



ACCESSORI FREEDOM BATTERY
FREEDOM BATTERY ACCESSORIES



Gancio da parete
Hook for wall

Gancio per piantana
Hook for floor

Piastra da terra
Ground plate

Lagoon

Servomuto



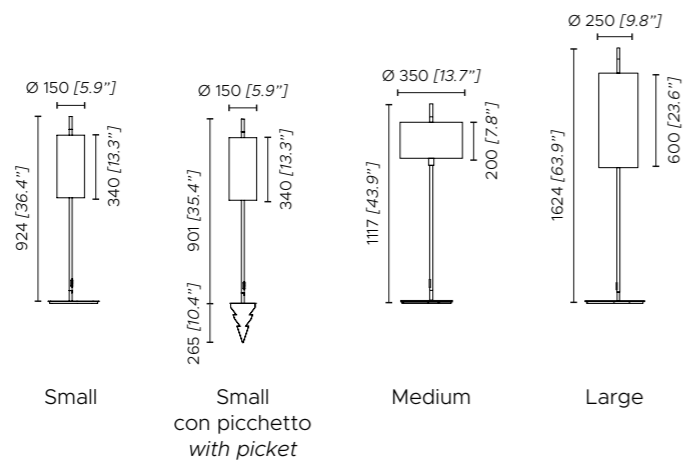

- 1. Laccato nero opaco
- 2. Laccato rame
- 3. Paralume Noumea Goyave (Pierre Frey)
- 4. Paralume Dominica Caraibes (Pierre Frey)
- 5. Paralume Bayamo Mimosa (Pierre Frey)

- 1. Matt black lacquered
- 2. Copper lacquered
- 3. Noumea Goyave shade (Pierre Frey)
- 4. Dominica Caraibes shade (Pierre Frey)
- 5. Bayamo Mimosa shade (Pierre Frey)

Fonte luminosa - Light source

220 - 240V:
1 x 9W E27 T8 Tubular LED

110V:
1 x 9W E26 T8 Tubular LED

IP65

IP65

Compatibile con sistemi di controllo remoto in caso di utilizzo di lampadine LED dimmerabili
Compatible with remote control systems when dimmable LED bulbs are used



Muse lantern outdoor

Tristan Auer



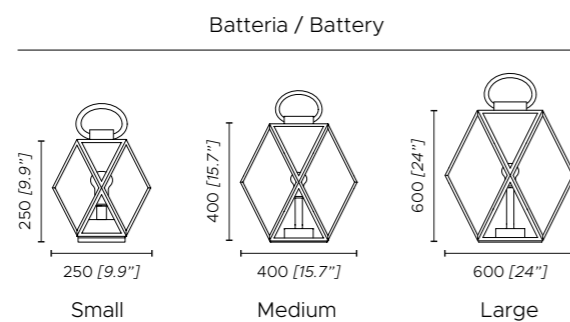

1. Laccato bronzo, trattamento cataforesi Marine Grade

2. Maniglia in cuoio intrecciata marrone

3. Diffusore acrilico color ambra

1. Bronze lacquered, Marine Grade with cataphoresis treatment

2. Brown braided leather handle

3. Amber acrylic diffuser

Fonte luminosa - Light source

220 - 240V:
Cablata/wired - so 1 x 10W E27 LED
Batteria/battery 1 x 3W LED module; 3000 K; CRI: >90

110V:
Cablata/wired - so 1 x 10W E26 LED
Batteria/battery 1 x 3W LED module; 3000 K; CRI: >90

IP65

IP65

Cablata/wired
 Compatible con sistemi di controllo remoto in caso di utilizzo di lampadine LED dimmerabili
 Compatible with remote control systems when dimmable LED bulbs are used



Cablata / Wired

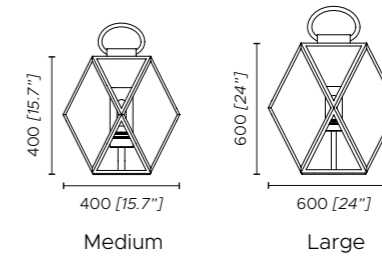

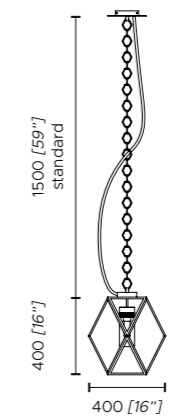

Medium suspension
(so medium)

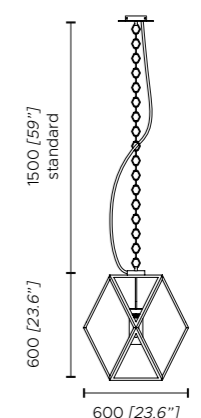

Large suspension
(so large)

Muse outdoor

Tristan Auer



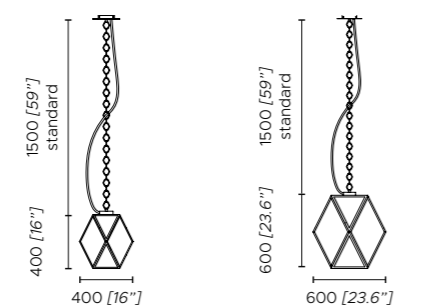

Medium suspension
(so medium)

Large suspension
(so large)

- 1. Laccato bianco opaco, trattamento cataforesi Marine Grade
- 2. Laccato nero opaco, trattamento cataforesi Marine Grade

- 3. Maniglia in cuoio intrecciato bianco/nero

- 4. Diffusore acrilico satinato

Fonte luminosa - Light source

220 - 240V:
Cablata/wired - so 1 x 10W E27 LED
Batteria/battery 1 x 3W LED module; 3000 K; CRI: >90

IP65

Cablata/wired

Compatibile con sistemi di controllo remoto in caso di utilizzo di lampadine LED dimmerabili
 Compatible with remote control systems when dimmable LED bulbs are used

- 1. Matt white lacquered, Marine Grade with cataphoresis treatment
- 2. Matt black lacquered, Marine Grade with cataphoresis treatment

- 3. White/black braided leather handle

- 4. Satin acrylic diffuser

110V:
Cablata/wired - so 1 x 10W E26 LED
Batteria/battery 1 x 3W LED module; 3000 K; CRI: >90

IP65



Cablata / Wired

Batteria / Battery

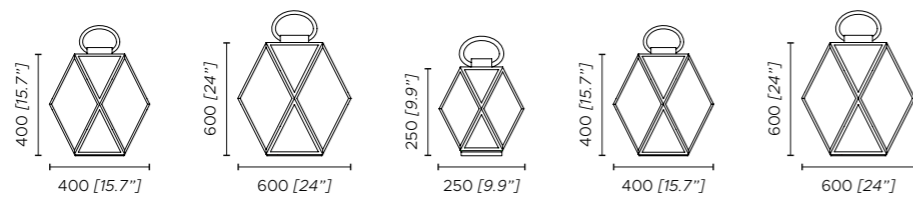



Tenebra

Jan Van Lierde





VERSIONE **A BATTERIA,**
SENZA ROSONE
BATTERY OPERATED
VERSION, WITHOUT CANOPY

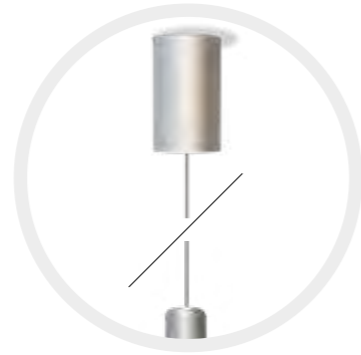

VERSIONE **CABLATA,**
CON ROSONE
WIRED VERSION,
WITH CANOPY

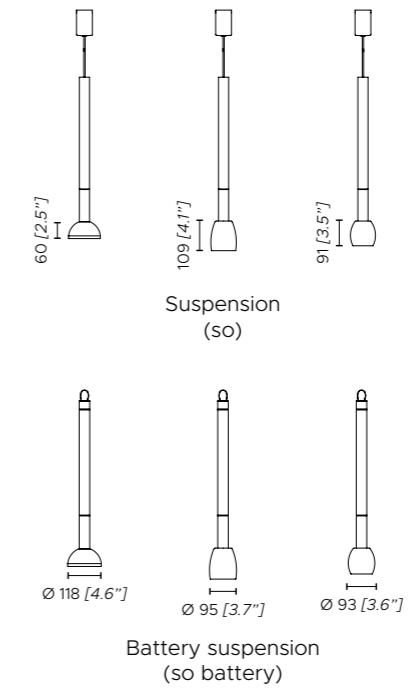

- 1. Laccato argento
- 2. Laccato oro rosa
- 3. Laccato nero opaco

Fonte luminosa - Light source

220 - 240V:
1 x 3W LED module; 2700 K; CRI: >90

IP65

Batteria/battery
Dimmerabile
Dimmable

- 1. Silver lacquered
- 2. Rose gold lacquered
- 3. Matt black lacquered

110V:
1 x 3W LED module; 2700 K; CRI: >90

IP65

ACCESSORI TENEBRA / TENEBRA ACCESSORIES

DIFFUSORI PER VERSIONE
CABLATA E A BATTERIAWIRED & BATTERY OPERATED
DIFFUSERS

1.



2.



3.

1. Diffusore cristallo sintetico, Venezia ambra
2. Diffusore cristallo sintetico, Lente grigio
3. Diffusore cristallo sintetico, Crystal Macedonia

1. Diffuser synthetic crystal, Venezia Amber
2. Diffuser synthetic crystal, Grey lens
3. Diffuser synthetic crystal, Crystal Macedonia

ACCESSORI DI FISSAGGIO
PER VERSIONE A BATTERIA (inclusi)BATTERY OPERATED
HANGING ACCESSORIES (included)

Accessori di fissaggio (inclusi)

1 x staffa per attacco a soffitti + 1 x griplock +
1 x bloccacavo + 1 x cavo in acciaio l. 2m +
1 x gancio standard

Hanging accessories (included)

1 x ceiling attachment + 1 x griplock + 1 x screw lock +
1 x steel cable l. 2m + 1 x standard hook



Accessori versione a batteria (non inclusi) / Battery operated version accessories (not included)



ACCESSORI "A" (non inclusi)
1 x cavo in acciaio l. 2m + 1 x gancio design

"A" ACCESSORIES (not included)
1 x steel cable l. 2m + 1 x design hook



ACCESSORI "B" (non inclusi)
1 x tirante + 2 x bloccacavo + 1 x cavo in acciaio l.10m +
6 x griplock

"B" ACCESSORIES (not included)
1 x tie rod + 2 x screw lock + 1 x steel cable l. 10m +
6 x griplock

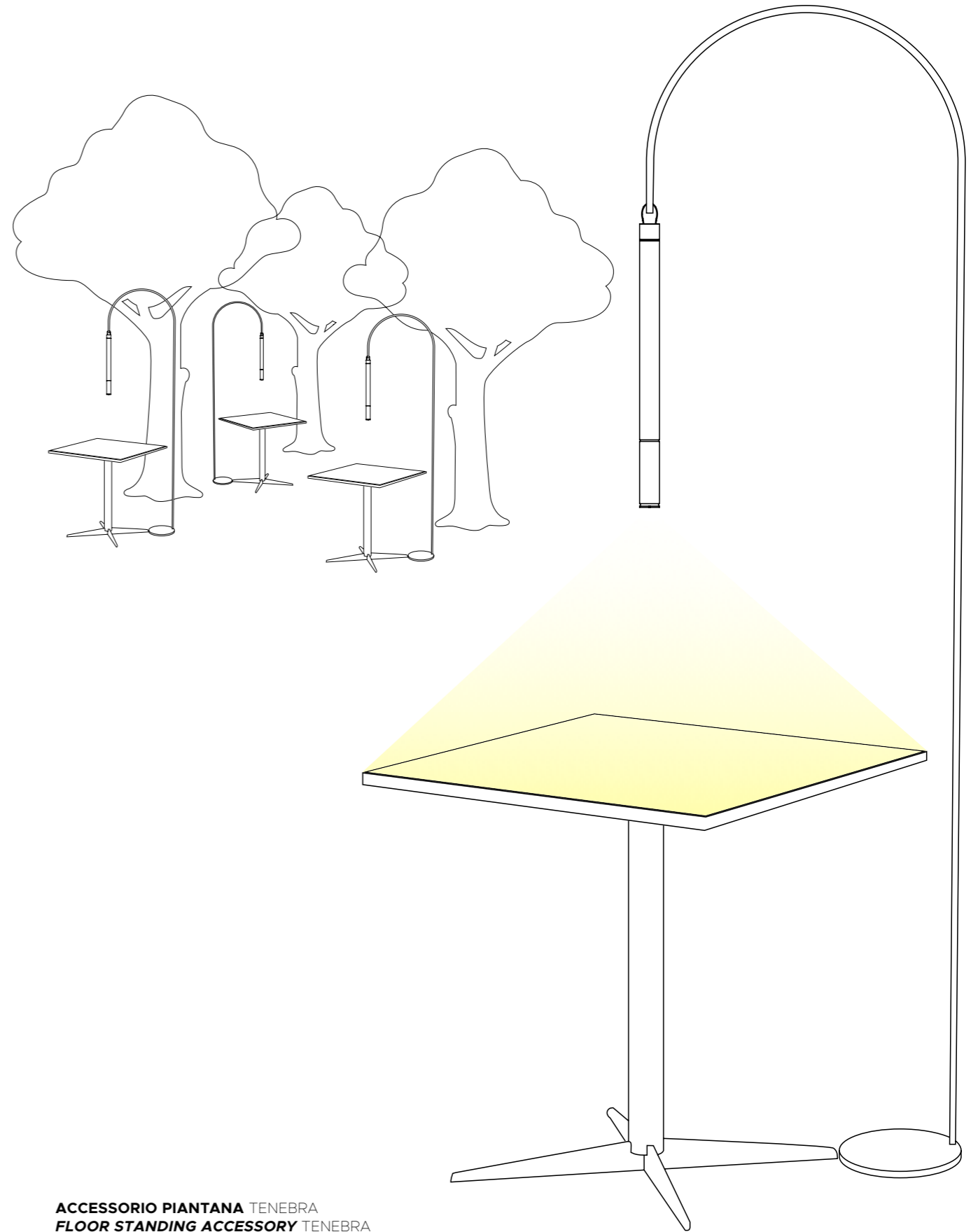

ACCESSORIO PIANTANA TENEBRA
FLOOR STANDING ACCESSORY TENEBRA



THANKS TO

Graphic Project:

Claudia Parisi

Photo Creative Direction:

STUDIOBLUM

Styling:

Martina Caiazzo

Mise en page:

Martina Castiglieri

Photos:

Francesco Romeo

Lakeroom

Marco Reggi

Render:

Operavisual

Studio Massimiliano Raggi

MKV Design

Arché Agency

Photos of page:

Casablanca Fotografia (p. 63)

Fabio Grande (p. 67)

Milène Servelle Photographe (p. 159)

Yvan Grubski Phothographer (p.7_i)

Francis Amiand Photographe (p. 62_out)

Stuart Pearce (p. 71_out)

Styling of page:

John Mac Donald, Tilburg (p. 42, 184)

BenchMark Design, Tilburg (p. 45)

NB-Studio, Moscow (p. 61)

Joaquim Homs (p. 63)

Alessandra Notarangelo Architetto, Italy (p. 67)

Grani Studio, Sochi (p. 98)

Tamma Architecture, Monaco (FR) (p. 147)

Goddard Little Fair, London (p. 178)

Maurizio Di Mauro Architetto, Italy (p. 181)

Maison Numéro 20 / Oscar Lucien Ono, Paris (p. 62_out)

Gunter & Co Interiors, London (p. 69_out)

FM Architettura d'interni, Italy (p. 71_out)

Thanks to:

MONOMIO

Ilya Barton

Jole Lombardini

Marco Billotti

Stefano Mandelli

Pietro Di Pace

Meroni e Colzani

CTS Salotti

Casa Casati

On House Milano

Thesign srl

Buro Tsum Restaurant, Moscow

Cavo Tagoo, Mykonos

Motel One Frankfurt Römer, Frankfurt

Fonteverde Hotel, San Casciano dei Bagni

Bartolo & Sons, Palermo

Egetemeier Wohnkultur, Germany

Sabrina Montecarlo, Monaco (FR)

Four Season Hotel Megeve, France

Print:

Grafiche Antiga, Crocetta del Montello (TV)

©Contardi Lighting srl

02.2023



CONTARDI LIGHTING Srl

Via A. Manzoni, 134/140 - 20811 Cesano Maderno (MB) - Italia
Tel. +39 0362 301381 - Fax +39 0362 307473

sales@contardi-italia.it - contardi-italia.com