



Cultura del vetro

2017

POP
LOLLIPOP
MAGMA
RIME
LANDS
LITWOOD
PLIÉ
EPSYLON
QUADRA
MACRAMÉ
RIALTO TRIS
INORI

La poesia è la vanità
di una materia
capace di riflettere
ciò che ci circonda
e di moltiplicare
i nostri punti di vista
sul reale.

Poetry is the vanity
of a material capable
of reflecting what
is around us increasing
our points of view
on reality.

Vittorio Livi

20 17.

NEW ITEMS



pop
DESIGN
MARCEL WANDERS



lollipop
DESIGN
MARCEL WANDERS



magma
DESIGN
PATRICK JOUIN



rime
BARTOLI DESIGN



lands
DESIGN
STUDIO KLASS

NEW FINISHES



LLT wood
DESIGN DANTE O. BENINI
E LUCA GONZO



plié
DESIGN
STUDIO KLASS



epsylon
DESIGN
FABIO DI BARTOLOMEI



quadra
DESIGN
MATTEO NUNZIATI



macramè
DESIGN
LUCIDIPEVERE



rialto tris
DESIGN
CRS FIAM



inori
DESIGN
SETSU E SHINOBU ITO

FIAM, cultura del vetro

Il vetro è un materiale magico ed eterno, quasi avesse un'intrinseca sacralità. Io ho accolto la sfida di questo materiale sin da quando ero ragazzo facendolo diventare praticamente una missione. Gettando le basi per un progetto che sembrava alle sue origini improbabile; far diventare il vetro in lastra un materiale protagonista nell'arredamento. Incanto e poesia, ecco quello che ancora mi trasmette il vetro. L'incanto di una materia senza tempo. La poesia è la vanità di una materia capace di riflettere ciò che ci circonda e di moltiplicare i nostri punti di vista sul reale.

FIAM, la culture du verre

Le verre est un matériau magique et éternel, qui semble posséder un caractère sacré intrinsèque. Dès mon plus jeune âge, j'ai voulu relever le défi de ce matériau, qui est bientôt devenu pour moi une mission. J'ai ainsi jeté les bases d'un projet qui semblait au départ improbable : conférer au verre en plaque une place de premier plan dans la décoration. Magie et poésie: ce sont les deux sensations que le verre m'a toujours procurées. La magie d'une matière intemporelle. La poésie, ou la vanité d'une matière capable de refléter tout ce qui nous entoure et de multiplier à l'infini nos perspectives sur la réalité.

FIAM, the art of glass

Glass is a magical and ever lasting material, as if it possessed an innate sacredness. I was young when I first accepted the challenge that this material represented and I set the basis for a project that initially seemed so unlikely possible: making glass become a furnishings star. Charm and poetry are still what glass conveys to me. The magic of a timeless material. Poetry is the vanity of a material capable of mirroring all that surrounds it and to multiply our perceptions of reality.

FIAM, die Kultur edles Glases

Glas ist ein zeitlos schönes Material mit magischer Ausstrahlung. Ich habe die Herausforderung dieses geheimnisvollen Materials schon in jungen Jahren angenommen, und in gewisser Weise zu meiner Mission auserkoren. Und damit die Grundlagen für ein Projekt geschaffen das zu Beginn beinahe aussichtslos erschien – die flache Glasscheibe zu einem Protagonisten der Einrichtung zu machen. Und auch heute noch vermittelt mir das Glas Zauber und Poesie. Den Zauber einer zeitlosen Materie. Die Poesie einer Materie, die ihre und unsere Umgebung reflektiert und unsere Blickpunkte auf die Realität vervielfacht.



pop
lollipop

6
16



SPECCHI
MIRRORS
MIROIRS
SPIEGEL



pop

DESIGN MARCEL WANDERS

Specchio rotondo.
Round mirror.

ø 148 x 5 cm
ø 58 1/4" x 2"

pop

DESIGN MARCEL WANDERS

Specchio da terra o da parete con cornice in vetro fuso a gran fuoco da 6 mm retroargentato; specchio piano da 5 mm. Telaio posteriore in metallo verniciato. Possibilità di appendimento verticale od orizzontale.

Wall mirror in 6 mm high temperature fused glass, back-silvered; 5 mm flat mirror. Rear frame in painted metal. It can be hung horizontally or vertically.

Miroir appuyant au sol et accrochable en verre en fusion de 6 mm argenté; miroir plat de 5 mm. Cadre arrière en métal verni. Possibilité d'accrochage en horizontal ou vertical.

Stand-bzw. Wandspiegel aus 6mm geschmolzenem Glas, versilbert; flacher Spiegel 5 mm stark. Hinterer Rahmen aus lackiertem Metall. Kann sowohl horizontal als auch vertikal aufgehängt werden.





Specchio sagomato.
Shaped mirror.
169 x 5 x 109 cm
66 7/16" x 2" x 43"





pop

DESIGN MARCEL WANDERS

Specchio rettangolare.
Rectangular mirror.

116 x 5 x 216 cm
45 11/16" x 2" x 85"

lollipop

DESIGN MARCEL WANDERS

Specchio da terra
o da parete in vetro fuso
da 8 mm retro argentato,
specchio piano da 5 mm.

Wall mirror in 8 mm
-thick fused and
back-silvered glass;
5 mm-thick flat mirror.

Miroir appuyant au sol
et accrochable à accrocher
en verre en fusion
de 8 mm argenté,
miroir plat de 5 mm.

Stand-bzw. Wandspiegel
aus 8 mm geschmolzenem
Glas, versilbert, flacher
Spiegel 5 mm stark.





lollipop

DESIGN MARCEL WANDERS

Specchio da parete.
Wall mirror.

200 x 10 x 90 cm
78 3/4" x 4" x 36 7/16"

Specchio da parete con accessori.
Wall mirror with accessories.

200 x 10 x 90 cm
78 3/4" x 4" x 36 7/16"



magma	24
rime	34
LLT wood	42
plié	46
epsilon	52



TAVOLI
TABLES
TABLES
TISCHE



Piano finitura ambr.
Base in rovere tinto grigio.
Amber finish glass top.
Grey finish oak base.
240 x 106 x 75 cm
94 1/2" x 41 3/4" x 29 1/2"

magma

DESIGN PATRICK JOUIN

Tavolo con piano in vetro da 15mm fuso a gran fuoco e temperato, disponibile nelle tinte trasparenti Fumo, Blu o Ambra. Struttura in legno rovere massello disponibile nelle finiture naturale o tinto grigio.

Table with 15 mm fused and tempered glass top, available in Smoke grey, Blue or Amber finish. Oak solid wood structure available in natural or grey finish.

Table avec plateau en verre en fusion de 15 mm trempé, disponible dans les teintes transparentes Fumée, Bleu ou Ambre. Structure en bois massif de chêne disponible dans les finitions naturelle ou de couleur grise.

Tisch mit Platte aus 15 mm geschmolzenem und gehärtetem Glas in den folgenden Ausführungen erhältlich: Rauch, Blau oder Bernstein. Untergestell aus massivem Eichenholz in den folgenden Ausführungen erhältlich: Natur oder Grau-gefärbt.



Struttura / Structure
Struktur / Structure



legno rovere naturale
natural oak
chêne naturel
Eichenholz

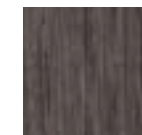

legno rovere tinto grigio
grey finish oak
chêne finition grise
Eichenholz Grau-gefärbt

Piano in vetro / Glass top
Platte aus Glas / Plateau en verre

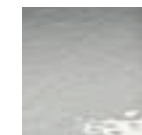

fumo
smoke grey
fumé
rauch



blu
blue
bleu
blau



ambra
amber
ambre
bernstein

Piano finitura fumo.
Base in rovere tinto grigio.

Smoke grey finish top.
Grey finish oak base.

240 x 106 x 75 cm
94 1/2" x 41 3/4" x 29 1/2"







Piáno finitura blu.
Base in rovere naturale.
Blue finish glass top.
Natural oak base.

240 x 106 x 75 cm
94 1/2" x 41 3/4" x 29 1/2"



Piano finitura blu.
Base in rovere naturale.

Blue finish glass top.
Natural oak base.

240 x 106 x 75 cm
94 1/2" x 41 3/4" x 29 1/2"



Piano finitura ecomalta tortora TNR.
Base in vetro extralight fuso.

Dove grey TNR ecomalta finish top.
Fused extralight glass base.

146 (236) x 146 x 75 cm
57 1/2" (93") x 57 1/2" x 29 1/2"

rime

BARTOLI DESIGN

Tavolo fisso o allungabile con piano in vetro temperato da 15 mm. Prolunghe indipendenti in vetro temperato da 12 mm lunghe 50 cm o 45 cm. Disponibile in diverse finiture: vetro extralight, acidato o liscio, retroverniciato bianco, nero o grigio; vetro spatolato a mano con Ecomalta ad effetto materico, disponibile in diversi colori: Avorio TBP, Tortora TNR, Nero Ardesia. Spatolatura tipo fine. Basamento composto da elementi in vetro extralight da 15mm fuso a gran fuoco.

Fix or extendible table with 15 mm tempered glass top. Independent 12 mm tempered glass extensions 50 cm-long or 45 cm-long. Available in various finishes: white, black or grey back-painted extralight glass, etched or smooth; glass hand-finished with Ecomalta for a textured effect, available in various colours: Ivory TBP, Dove-grey TNR, Black Slate. Fine texture finish. 15 mm extralight fused glass base.

Table fixe ou à rallonges avec plateau en verre trempé de 15 mm. Rallonges indépendantes en verre trempé de 12 mm, longueur 50 cm o 45 cm. Différentes finitions disponibles: verre extra light laqué au dos en blanc, noir ou gris, verre extra light dépoli laqué au dos en blanc, noir ou gris; verre enduit à la main avec Ecomalta avec effet matière, disponible dans différentes couleurs: Ivoire TBP, Tourterelle TNR, Noir Ardesia. Finition Texture au grain fin. Base composé d'éléments en verre extralight en fusion de 15 mm.

Tisch oder ausziehbarer Tisch mit gehärtetem Platte, Stärke 15 mm. Glasverlängerungen, Stärke 12 mm., in der Länge 50 cm oder 45 cm. Platte in den folgenden Ausführungen erhältlich: Extra light oder extra light geätztes Glas weiß, schwarz oder grau lackiert, oder mit Ecomalta, handgespachteltem Effekt auf Glas. Ausführungen Ecomalta: Elfenbein TBP, Taubengrau TNR, Schwarz Ardesia. Feine textilhähnliche Bearbeitung. Untergestell aus 15mm geschmolzenem extralight Glas.



Piano in vetro extralight retroverniciato
Back-painted extralight glass top
Plateau en verre extralight laqué au dos
Platte aus extralight Glas, unterlackiert



bianco
white
blanc
weiß

nero
black
noir
schwarz

grigio
grey
gris
grau

Piano in vetro spatolato con Ecomalta
Ecomalta finish glass top
Plateau en verre finition Ecomalta
Ecomalta hanbespachtelte Glasplatte



avorio TBP
ivory TBP
Ivoire TBP
Elfenbein TBP

tortora TNR
dove-grey TNR
tourterelle TNR
Taubengrau TNR

nero ardesia
black slate
Noir Ardesia
Schwarz Ardesia





Piano in vetro extralight acidato
retroverniciato nero.
Base in vetro extralight fuso.

Black back-painted and etched
extralight glass.
Fused extralight glass base.

146 (236) x 146 x 75 cm
57 1/2" (93") x 57 1/2" x 29 1/2"



Piano in vetro extralight acidato
retroverniciato nero.
Base in vetro extralight fuso.

Black back-painted and etched
extralight glass.
Fused extralight glass base.

146 (236) x 146 x 75 cm
57 1/2" (93") x 57 1/2" x 29 1/2"



Piano finitura ecomalta argilla.
Base vetro extralight.

Clay brown ecomalta finish top.
Extralight glass base.

240 x 100 x 74 cm
94 1/2" x 39 3/8" x 29 1/8"

LLT wood

DESIGN DANTE O. BENINI E LUCA GONZO

Tavolo con piano in legno multistrato marino da 40 mm impiallacciato noce canaletto, rovere "old" o rovere termotrattato, oppure in legno spatolato a mano con Ecomalta ad effetto materico, disponibile in diversi colori: Argilla, Fango M25, Calce M42. Spatolatura tipo materica. Struttura in vetro trasparente o extralight stratificato da 30 mm e gambe in vetro trasparente o extralight da 19 mm.

Table with top in 40 mm multilayered marine plywood veneered, canaletto walnut, "old style" oak finish or heat-treated oak finish, or in wood hand-finished with Ecomalta for textured effect, available in various colours: Clay brown, Mud brown M25, Lime grey M42. Rough texture finish. Structure in 30 mm layered glass, transparent or extralight and legs in 19 mm transparent or extralight glass.

Table avec plateau en bois multiplis marine 40 mm, plaqué noyer noir, chêne vieilli ou chêne traité thermiquement ou en bois enduit à la main avec Ecomalta - effet matière, disponible dans différentes couleurs: Argile, Boue M25, Chaux M42. Finition texture irrégulière. Structure en verre transparent ou extralight feuilleté de 30 mm et pieds en verre transparent ou extralight de 19 mm.

Tisch mit Platte aus 40 mm Multiplex-Holz in den folgenden Ausführungen erhältlich: Nussbaumfurnier, Eichenholzfurnier aus alten Eichebalken, Eichenholzfurnier wärmebehandelt oder mit Ecomalta, handgespachteltem Effekt auf Holz. Ausführungen Ecomalta: Tonbraun, Lehmbraun M25, Kalk M42. Textilhähnliche Bearbeitung. Struktur aus 30 mm transparentem oder extralight Verbundglas. Beine aus 19 mm transparentem oder extralight Glas.



Piano in legno / Plywood top
Platte aus Holz / Plateau en bois

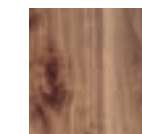

noce canaletto
canaletto walnut
noyer canaletto
Nussbaum-furnier



rovere "old"
"old style"
oak finish
chêne vieilli
"antike"
Eichenholz



rovere termotrattato
heat-treated oak finish
chêne traité thermiquement
Eichenholzfurnier wärmebehandelt

Piano in legno spatolato con Ecomalta / Ecomalta hand-finished wood top
Plateau en bois enduit à la main avec Ecomalta
Ecomalta handgespachtelte Holzplatte

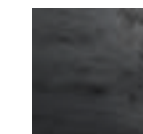

argilla
clay brown
argile
Tonbraun



fango M25
mud brown M25
boue M25
Lehmbraun M25

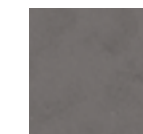

calce M42
lime grey M42
chaux M42
Kalk M42

NUOVE FINITURE / NEW FINISHES



Piano in legno finitura olmo.
Base vetro extralight.
Elm-finish wood top.
Extralight glass base.
240 x 100 x 74 cm
94 1/2" x 39 3/8" x 29 1/8"

plié

DESIGN STUDIO KLASS

Tavolo composto da due basi in vetro sagomato e curvato da 12 mm, disponibili in vetro fumé o extralight; piano disponibile in vetro extralight, oppure in legno impiallacciato finitura rovere termotrattato o finitura olmo, oppure in legno spatolato a mano con Ecomalta ad effetto materico, colore Argilla. Spatolatura tipo materica.

Table consisting of two 12 mm shaped and curved glass bases, available in smoked or extralight glass; top available in extralight glass, or in veneered wood with heat-treated oak or elm finish, or in wood hand-finished with Ecomalta for textured effect, clay colour. Rough texture finish.

Table composée de deux bases en verre, façonné et cintré de 12 mm, disponibles en verre fumé ou extralight; plateau disponible en verre extralight, ou en bois plaqué finition chêne thermotraité ou finition orme, ou en bois enduit à la main avec Ecomalta avec effet matière couleur Argile. Finition texture irrégulière.

Tisch bestehend aus 2 geformten und gebogenen Basiselementen in Rauchglas oder extralight Glas, Stärke 12 mm. Tischplatte lieferbar in 15 mm starkem extralight Glas oder aus furniertem Holz, verfügbar in den folgenden Ausführungen: Holz, Ulme und wärmebehandelte Eiche oder in Ecomalta, hat einen handgespachteltem Effekt. Textilhähnliche Bearbeitung.



Piano in legno
Wood top
Plateau en bois
Holzplatte



rovere
termotrattato
heat-treated
oak finish
chêne traité
thermiquement
Eichenholz furnier
wärmebehandelt



olmo
elm finish
orme
Ulme

NUOVA FINITURA
NEW FINISHES



plié

DESIGN STUDIO KLASS

Tavolo composto da due basi in vetro sagomato e curvato da 12 mm, disponibili in vetro fumè o extralight; piano disponibile in vetro extralight, oppure in legno impiallacciato finitura rovere termotrattato o finitura olmo, oppure in legno spatolato a mano con Ecomalta ad effetto materico, colore Argilla. Spatolatura tipo materica.

Table consisting of two 12 mm shaped and curved glass bases, available in smoked or extralight glass; top available in extralight glass, or in veneered wood with heat-treated oak or elm finish, or in wood hand-finished with Ecomalta for textured effect, clay colour. Rough texture finish.

Table composée de deux bases en verre, façonné et cintré de 12 mm, disponibles en verre fumé ou extralight; plateau disponible en verre extralight, ou en bois plaqué finition chêne thermotraité ou finition orme, ou en bois enduit à la main avec Ecomalta avec effet matière couleur Argile. Finition texture irrégulière.

Tisch bestehend aus 2 geformten und gebogenen Basiselementen in Rauchglas oder extralight Glas, Stärke 12 mm. Tischplatte lieferbar in 15 mm starkem extralight Glas oder aus furniertem Holz, verfügbar in den folgenden Ausführungen: Holz, Ulme und wärmebehandelte Eiche oder in Ecomalta, hat einen handgespachteltem Effekt. Textilhähnliche Bearbeitung.



Piano spatolato in Ecomalta.
Hand-finished Ecomalta wood top.
Plateau en bois enduit
à la main avec Ecomalta.
Ecomalta handbegepachtelte
Holzplatte.

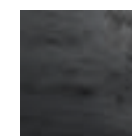

argilla
clay brown
argile
Ton

NUOVA FINITURA
NEW FINISHES

Piano finitura ecomalta argilla.
Base vetro fumè.

Clay brown ecomalta finish top.
Smoked glass base.

240 x 100 x 74 cm
94 1/2" x 39 3/8" x 29 1/8"

epsylon

DESIGN FABIO DI BARTOLOMEI

Tavolo con piano in vetro trasparente, extralight, o bronzo da 10 mm temperato. Struttura in acciaio finitura cromato oppure ottone brunito effetto nuvolato. Piastre di fissaggio in acciaio inox o in ottone. Il tavolo Epsylon è disponibile anche con piani su misura, diametro da 90 a 140 cm.

Table with 10 mm-thick tempered transparent, extralight or bronze glass top. Chromed or burnished brass finish legs; stainless steel or brass fixing plates. The Epsylon table is also available with customized top, diameter from 90 cm to 140 cm.

Tisch mit Platte aus 10 mm gehärtetem Glas in den folgenden Ausführungen erhältlich: transparentes Glas, extralight Glas oder Bronzeglas. Beine aus verchromtem oder getöntem Messing, Befestigungsplättchen aus Edelstahl oder aus Messing. Auch mit maßgefertigter Platte erhältlich, Durchmesser von 90 bis 140 cm.

Table avec plateau en verre trempé de 10 mm, transparent ou en verre extralight ou en verre bronze. Pieds en acier chromé ou finition laiton bruni de 10 mm, plaques de fixation en acier inoxydable ou en laiton. La table Epsylon est également disponible avec de plateau sur mesure, diamètre de 90 à 140 cm.



Piano in vetro bronzo.
Base finitura
ottone brunito.
Bronze glass top.
Burnished brass finish legs.

Ø 120 x 75 cm
Ø 47 1/2 x 29 1/2"



quadra	56
lands	60
macramè	66
rialto tris	68

TAVOLI BASSI
E DI SERVIZIO

COFFEE TABLES
AND SIDE TABLES

TABLES BASSES
ET D'APPOINT

COUCHTISCHE
UND BEISTELLTISCHE

quadra

DESIGN MATTEO NUNZIATI



Base in vetro bronzo
retroargentato.

Back-silvered bronze
glass base.

160 x 80 x 34 cm
32" x 31 1/2" x 13 3/8"

quadra

DESIGN MATTEO NUNZIATI

Tavolino contenitore
composto da 4 elementi
in vetro curvato da 10 mm
interposti tra 2 piani
in vetro da 10 mm.
Piano superiore e divisori
in vetro extralight; basi
nelle seguenti varianti:
vetro extralight
trasparente,
vetro extralight
retroverniciato bianco,
vetro extralight
retroargentato,
vetro bronzo
retroargentato,
vetro Nero95.

Coffee table/storage unit
composed of 4 elements
in 10 mm curved glass
mounted between
two 10 mm glass
racks.
Top and partitions
in extralight glass,
bases available
in extralight glass,
extralight glass
back-painted white,
extralight mirrored glass,
back-silvered bronze
glass, black95 glass.

Table basse de rangement
constituée de 4 éléments
en verre cintré
de 10 mm interposés
entre 2 plateaux
en verre de 10 mm.
Plateau supérieur
et cloisons en verre
extralight transparent;
bases dans les variantes
suivantes: verre extralight
transparent, verre
extralight verni dessous
blanc, verre extralight
argenté, verre bronze
argenté, verre noir 95.

Couchtisch mit Stauraum
aus viern Elementen
aus 10 mm starkem,
gebogenem Glas zwischen
zwei 10 mm starken
Glasplatten. Obere
Platte und Trennelemente
aus Extralight-Glas,
Basis in den folgenden
Ausführungen:
Extralight-Glas, Extralight-
Glas hinterlackiert weiß,
Extralight-Glas
versilbert, Bronzeglas
versilbert, Glas
"Schwarz95".



Base in vetro bronzo
retroargentato.

Back-silvered bronze
glass base.

160 x 80 x 34 cm
32" x 31 1/2" x 13 3/8"





lands

DESIGN STUDIO KLASS

Collezione di tavolini composti da piano in vetro extralight da 6 mm retroverniciato nero, oppure in gres da 6 mm disponibile in diverse finiture. Il piano è applicato ad un pannello strutturale bordato da una fascia verniciata finitura rame satinato. Basi in vetro soffiato artigianalmente disponibili nelle finiture fumè o Ambra.

Collection of coffee tables consisting of 6 mm, black back-painted extralight glass top or in 6 mm stoneware available in various colours. The top is set on a structured panel edged with a painted band, with a satin copper finish. Hand-blown glass base, available in smoked or Amber finish.

Collection de tables basses composées d'un plateau en verre extralight de 6 mm laqué au dos en noir ou en grès de 6 mm, disponible dans différentes finitions. Le plateau est appliqué à un panneau structurel bordé d'une bande peinte avec finition cuivre satiné. Bases en verre soufflé artisanalement, disponibles dans les finitions fumé ou Ambre.

Kollektion von Couchtischen mit Platte Stärke 6mm aus schwarz lackiertem extra light Glas oder auf Steinzeug erhältlich. Die Tischplatte ist auf einer Grundplatte befestigt und mit einer lackierten Kante aus satiniertem Kupfer umrandet. Basis aus handwerklich geblasenem Glas in den Ausführungen Rauch oder Bernstein erhältlich.



Tavolini rettangolari.
Rectangular coffee tables.
Table basse rectangulaires.
Rechteckiger Couchtischen.

90 x 45 x 30 cm
35 7/16" x 17 11/16" x 11 13/16"
90 x 45 x 40 cm
35 7/16" x 17 11/16" x 15 3/4"
130 x 35 x 30 cm
51 3/16" x 13 3/4" x 11 13/16"
130 x 35 x 40 cm
51 3/16" x 13 3/4" x 15 3/4"

Tavolini tondi.
Round coffee tables.
Tables basses rondes.
Runder Couchtischen.

Ø 90 x 30 cm
Ø 35 7/16" x 11 13/16"
Ø 120 x 30 cm
Ø 47 1/4" x 11 13/16"
Ø 120 x 40 cm
Ø 47 1/4" x 15 3/4"

Piano in vetro
Glass top
Plateau en verre
Glasplatte



retroverniciato nero
black back-painted
laqué au dos en noir
schwarz hinterlackiert

Piano in gres
Stoneware top
Plateau en grès
Platte aus Steinzeug



venus

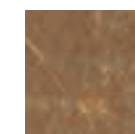

glam bronze

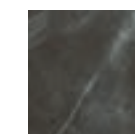

pietra grey

Basi in vetro
Glass base
Bases en verre
Glas Basis



fumè
smoked
fumé
Rauch



ambra
amber
ambre
Bernstein





macramè

DESIGN LUCIDIPEVERE

Collezione di tavolini composti da una base in vetro filato intrecciato in maniera artigianale e da un piano di vetro da 10 mm. La collezione di tavolini prevede le seguenti finiture: piano in vetro extralight con base in vetro extralight, piano in vetro bronzo con base verniciata bronzo, piano in vetro fumè con base verniciata fumè.

Collection of coffee tables comprising hand-interwoven spun glass base and 10 mm-thick glass top. The coffee table collection includes the following finishes: extralight glass top with extralight glass base; bronze glass top with bronze painted base; smoked glass top with smoke grey painted base.

Tables basses composées d'une base en verre filé tressé de manière artisanale et d'un plateau en verre de 10 mm. La collection de tables basses propose les finitions suivantes: plateau verre extralight avec base en verre extralight, plateau en verre bronze avec base peinte coloris bronze, plateau en verre fumé avec base peinte coloris fumé.

Tisch mit Unteruntergestell aus handwerklich gefertigtem Glasfädengeflecht und 10 mm starker Glasplatte. Lieferbar in den Finishes: Glasplatte und Untergestell aus extralight Glas, Bronzeglas Platte mit Untergestell Bronze lackiert, Rauchglas Platte mit Untergestell Rauch lackiert.



Piano in vetro fumè.
Base verniciata fumè.

Smoked glass top.
Smoke grey painted base.

90 x 65 x 33 cm
35 7/8" x 25 9/16" x 12"

130 x 86 x 33 cm
51 3/16" x 33 7/8" x 12"

60 x 60 x 40 cm
23 5/8" x 23 5/8" x 15 3/4"

50 x 50 x 50 cm
19 11/16" x 19 11/16" x 19 11/16"



rialto tris

DESIGN CRS FIAM

Composizione di tavoli bassi in vetro curvato da 10 mm. Disponibile anche in vetro extralight, NERO 95 o in vetro bronzo retroargentato. È possibile realizzare Rialto tris su misura.

Set of coffee tables in 10 mm-thick curved glass. Also available in extralight glass, Black 95 (NERO 95) glass or back-silvered bronze glass and in customized sizes.

Composition de tables basses en verre cintré de 10 mm. Disponible aussi en verre extra-clair, verre Noir 95, verre bronze ou verre bronze dessous argenté.

Komposition von Couchtischen aus gebogenem Glas 10 mm. Auch in den folgenden Ausführungen lieferbar: extralight Glas oder Schwarz 95 Glas oder Bronzeglas oder versilbertes Bronzeglas.



Vetro bronzo retroargentato.

Back-silvered bronze glass.

39,5 x 40 x 37,5 cm
15 9/16" x 15 3/4" x 14 3/4"

47,5 x 45 x 41,5 cm
18 11/16" x 17 11/16" x 16 5/16"

55,5 x 50 x 45,5 cm
21 7/8" x 19 11/16" x 17 15/16"

inori

72

LIBRERIE,
SISTEMI

BOOKSHELVES,
SYSTEMS

BIBLIOTHÈQUES,
SYSTÈMES

BÜCHERREGALE,
SYSTEME





inori

DESIGN SETSU E SHINOBU ITO

Sistema composto da base e ripiani in legno Rovere "Old"; montanti in vetro extralight da 12 mm.

System consisting of base and shelves in "Old Style" oak; uprights in 12 mm extralight glass.

Système composée d'une base et d'étagères en bois Chêne veilli, montants en verre extralight de 12 mm.

System mit Basis und Fachboden aus Eichenholz aus alten Eichebalken. Stützen aus extra light Glas, Stärke 12mm.



Base e ripiani in legno Rovere "Old".
Montanti in vetro extralight.

Base and shelves in "Old Style" oak; uprights in extralight glass



SCHEDE
TECNICHE
TECHNICAL
DATA SHEETS
FICHES
TECHNIQUE
DATENBLÄTTER

SPECCHI _ MIRRORS

pop
DESIGN
MARCEL WANDERS

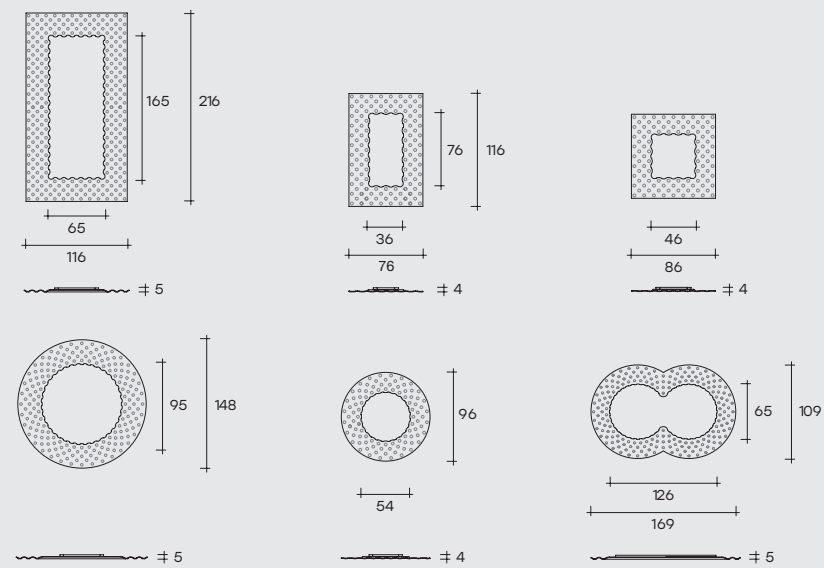

NEW ITEMS

lollipop
DESIGN
MARCEL WANDERS

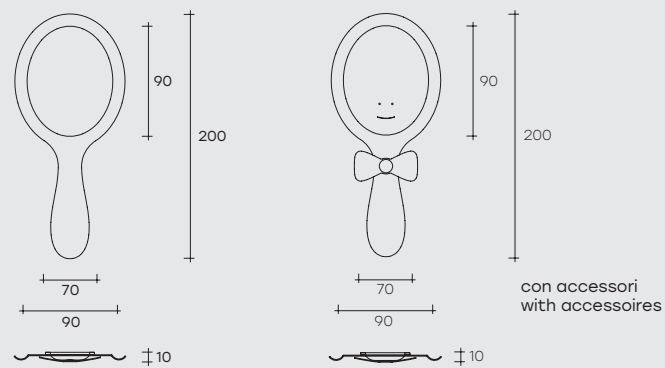

NEW ITEMS

TAVOLI _ TABLES

magma
DESIGN
PATRICK JOUIN

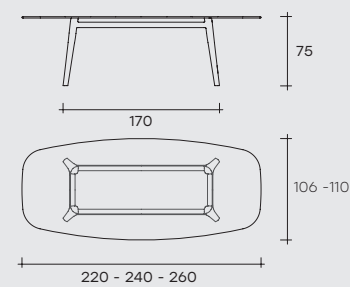

NEW ITEMS

rime
BARTOLI DESIGN

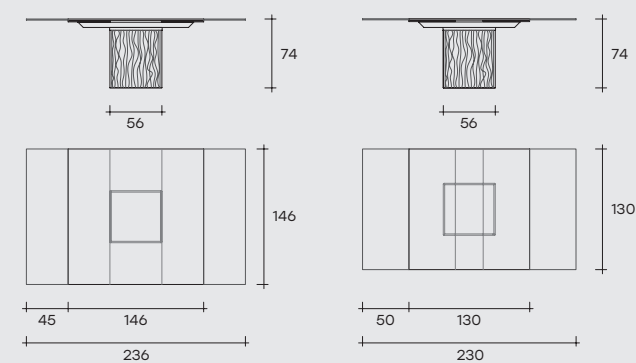

NEW ITEMS

TAVOLI _ TABLES

plié
DESIGN
STUDIO KLASS



Top in legno / Wood top

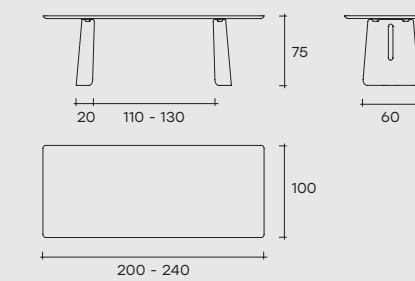

NEW FINISHES

Top in vetro / Glass top

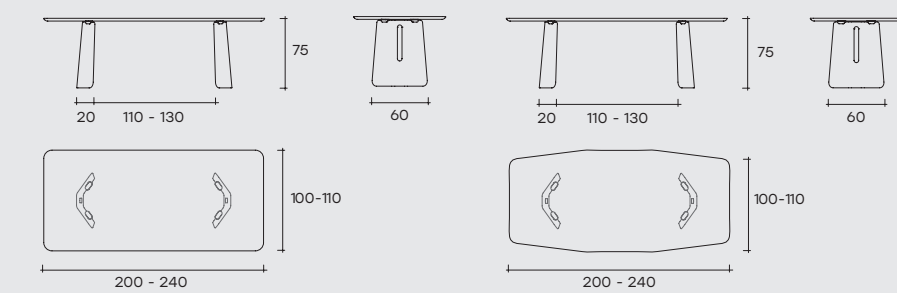

LLT wood
DESIGN DANTE O. BENINI
E LUCA GONZO

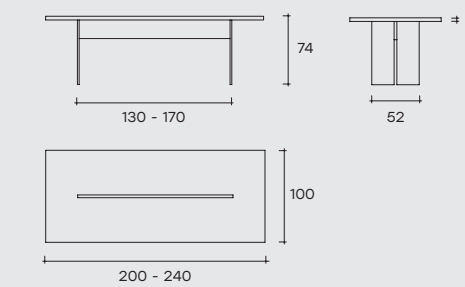

NEW FINISHES

epsilon
DESIGN
FABIO DI BARTOLOMEI

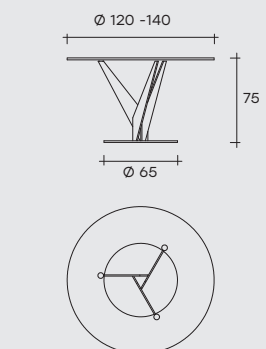

NEW FINISHES

TAVOLI BASSI E DI SERVIZIO _ COFFEE TABLES AND SIDE TABLES

lands

DESIGN
STUDIO KLASS

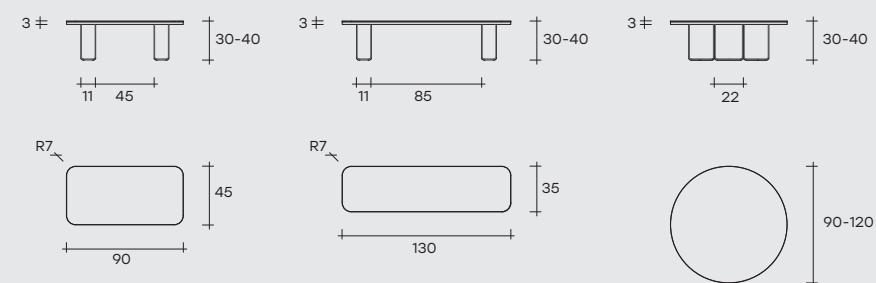

NEW ITEMS

quadra

DESIGN
MATTEO NUNZIATI

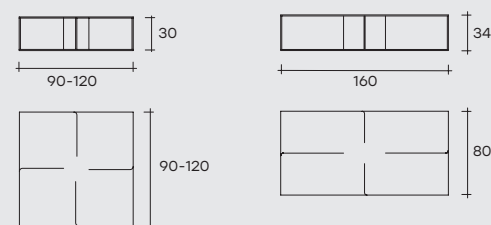

NEW FINISHES

rialto tris

DESIGN
CRS FIAM

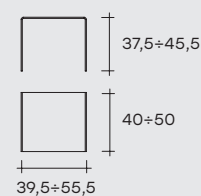

NEW FINISHES

macramè

DESIGN
LUCIDIPEVERE

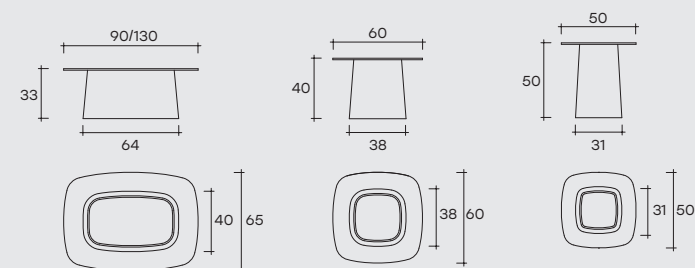

NEW FINISHES

LIBRERIA _ BOOKCASE

inori

DESIGN
SETSU
E SHINOBU ITO

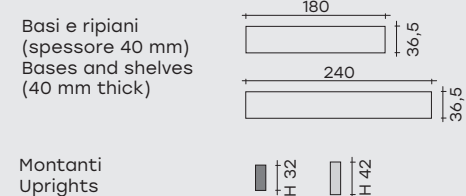

NEW FINISHES

art direction
acanto comunicazione
(carlo piazzesi)

graphic design and layout
acanto comunicazione
(katia fornaroli)

photography
studio leon

styling
candida zanelli
and serenella parri

marketing project
daniele livi

coordination and logistics
lorenzo marzoli

selections
olimpia visual plan

print and packaging
grapho 5

credits

ARTEK
BONACINA 1889
FONTANAARTE
KASTHALL
RINA MENARDI
ATELIER POLYHEDRE
REZINA
ANTONINO SCIORTINO
VITRA

Fiam Italia
Via Ancona 1/b
61010 Tavullia (PU), Italia
Tel. 0039 0721 20051
Fax: 0039 0721 202432

www.fiamitalia.it
info@fiamitalia.it

#fiamitalia



Premio Leonardo
Qualità Italia 2015



fiamitalia.it

