



FIAM

Cultura del vetro

2

TAVOLI  
TABLES

TAVOLI BASSI  
E DI SERVIZIO  
COFFEE TABLES  
AND SIDE TABLES

COMODINI  
BEDSIDE TABLES

CONSOLLE  
CONSOLES

SEDIE  
CHAIRS

La poesia è la vanità  
di una materia  
capace di riflettere  
ciò che ci circonda  
e di moltiplicare  
i nostri punti di vista  
sul reale.

Poetry is the vanity  
of a material capable  
of reflecting what  
is around us increasing  
our points of view  
on reality.

Vittorio Livi

<b>2</b>	Indice generale prodotti General product index	2
	FIAM, Cultura del vetro FIAM, the art of glass	10
	Designer e riconoscimenti Designers and awards	12
	Ecosostenibilità Ecosustainable	16
	Poltrona Ghost Ghost armchair	26
	<b>TAVOLI TABLES</b>	30
	<b>TAVOLI BASSI E DI SERVIZIO COFFEE TABLES AND SIDE TABLES</b>	174
	<b>COMODINI BEDSIDE TABLES</b>	270
	<b>CONSOLLE CONSOLES</b>	290
	<b>SEDIE CHAIRS</b>	320
	Mini collection Mini collection	360
	I Customizzabili The Customizables	362
	Schede tecniche Technical data sheet	372
	Materiali Materials	456
	Garanzia di qualità e certificazioni Guarantee of quality and certifications	462

<b>1</b>	SPECCHI MIRRORS
	SPECCHI TV MIRRORS-TV
	ESPOSITORI, VETRINE, CONTENITORI SHOWCASES, DISPLAY UNITS, CONTAINER CABINETS
	LIBRERIE, SISTEMI BOOKSHELVES, SYSTEMS
	MENSOLE SHELVES
	ACCESSORI ACCESSORIES

<b>3</b>	HOME OFFICE CUSTOM MADE & CONTRACT
----------	--

# INDICE

## INDEX

## SOMMAIRE

## INHALTSVERZEICHNIS

ghost 26  
DESIGN  
CINI BOERI

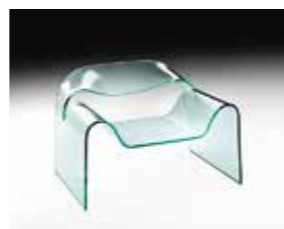

TAVOLI  
TABLES  
TISCHE  
30

atlas 144  
DESIGN  
DANNY LANE



big wave 40  
DESIGN LUDOVICA  
+ ROBERTO PALOMBA



coral beach 32  
DESIGN  
MAC STOPA



corner 156  
DESIGN  
CRS FIAM



epsilon 88  
DESIGN  
FABIO DI BARTOLOMEI



hype 62  
DESIGN  
STUDIO KLASS



kayo 166  
DESIGN  
SATYENDRA PAKHALÉ



kighi 52  
DESIGN  
SETSU & SHINOBU ITO



LLT 116  
DESIGN  
DANTE O. BENINI E LUCA GONZO



LLT wood 124  
DESIGN  
DANTE O. BENINI E LUCA GONZO



luxor 148  
DESIGN  
RODOLFO DORDONI



magma 92  
DESIGN  
PATRICK JOUIN



plié 136  
DESIGN  
STUDIO KLASS



ragno 142  
DESIGN  
VITTORIO LIVI



ray 158  
DESIGN  
BARTOLI DESIGN



ray plus 162  
DESIGN  
BARTOLI DESIGN



rime 108  
DESIGN  
BARTOLI DESIGN



sahara 152  
DESIGN  
BARTOLI DESIGN



theo 80  
DESIGN  
SIMONE BONANNI



waves 48  
DESIGN  
SIMONE BONANNI



# INDICE

## INDEX

## SOMMAIRE

## INHALTSVERZEICHNIS

**TAVOLI BASSI  
E DI SERVIZIO**  
COFFEE TABLES  
AND SIDE TABLES  
TABLES BASSES  
ET D'APPOINT  
COUCHTISCHE  
UND  
BEISTELLTISCHE  
174

**atlas 216**

DESIGN  
DANNY LANE



**cannage 176**

DESIGN  
EMMANUEL GALLINA



**charlotte 254**

DESIGN  
PROSPERO RASULO

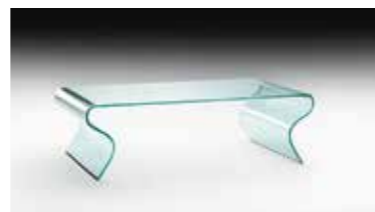

**grillo 262**

DESIGN  
VITTORIO LIVI



**hype 204**

DESIGN  
STUDIO KLASS



**lakes 194**

DESIGN  
STUDIO KLASS



**macramè 240**

DESIGN  
LUCIDI PEVERE



**macramè large 238**

DESIGN  
PAOLO LUCIDI E LUCA PEVERE



**magique 264**

DESIGN  
STUDIO KLASS



**magma 202**

DESIGN  
STUDIO KLASS



**neutra 224**

DESIGN  
RODOLFO DORDONI



**pixel 210**

DESIGN  
VITTORIO LIVI



**ponte 256**

DESIGN  
ANGELO CORTESI

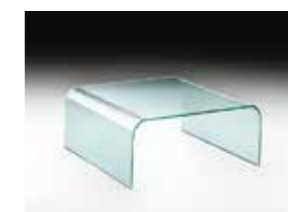

**quadra 228**

DESIGN  
MATTEO NUNZIATI



**rialto 244**

DESIGN  
CRS FIAM



**rialto piano 248**

DESIGN  
CRS FIAM



**rialto side 249**

DESIGN  
CRS FIAM



**rialto tris 250**

DESIGN  
CRS FIAM



**roy 234**

DESIGN  
DORIANA E MASSIMILIANO FUKSAS



**shell 220**

DESIGN  
DANNY LANE



**sigmy 258**

DESIGN  
AQUILI - ALBERG

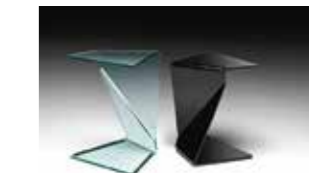

# INDICE

## INDEX

## SOMMAIRE

## INHALTSVERZEICHNIS

**TAVOLI BASSI  
E DI SERVIZIO**  
COFFEE TABLES  
AND SIDE TABLES  
TABLES BASSES  
ET D'APPOINT  
COUCHTISCHE  
UND  
BEISTELLTISCHE  
174

**toki 260**

DESIGN  
SETSU & SHINOBU ITO



**waves 182**

DESIGN LUDOVICA  
+ ROBERTO PALOMBA



**COMODINI**  
BEDSIDE TABLES  
TABLES DE CHEVET  
NACHTTISCHE  
270

**charlotte de nuit 280**

DESIGN  
PROSPERO RASULO



**dino 272**

DESIGN  
CRS FIAM



**grillo 284**

DESIGN  
VITTORIO LIVI



**magique cubo 288**

DESIGN  
STUDIO KLASS



**milo 286**

DESIGN  
ILARIA MARELLI



**rialto night 276**

DESIGN  
CRS FIAM



**toki 282**

DESIGN  
SETSU & SHINOBU ITO



**CONSOLE**  
CONSOLES  
CONSOLES  
KONSOLE  
290

**charlotte 310**

DESIGN  
PROSPERO RASULO



**dama 308**

DESIGN  
PROSPERO RASULO



**elementare 318**

DESIGN  
ENRICO TONUCCI



**hype 296**

DESIGN  
STUDIO KLASS



**let me see 312**

DESIGN  
RODOLFO DORDONI



**LLT consolle 306**

DESIGN  
DANTE O. BENINI E LUCA GONZO



**lunar 302**

DESIGN  
MATTEO NUNZIATI



# INDICE

## INDEX

## SOMMAIRE

## INHALTSVERZEICHNIS

---

**CONSOLLE**  
CONSOLES  
CONSOLES  
KONSOLE  
290

**rialto consolle** 316

DESIGN  
CRS FIAM



**waves** 292

DESIGN LUDOVICA  
+ ROBERTO PALOMBA



**SEDIE**  
CHAIRS  
CHAISES  
STÜHLE  
320

**bacall** 348

DESIGN  
THIS WEBER



**brigitte** 356

DESIGN  
FABIO DI BARTOLOMEI



**callas** 344

DESIGN  
THIS WEBER



**dress** 352

DESIGN  
ARCHIRIVOLTO DESIGN



**easy lloyd** 326

DESIGN  
STUDIO KLASS



**kamy** 340

DESIGN  
SETSU & SHINOBU ITO



**lloyd** 322

DESIGN  
STUDIO KLASS



**magma** 330

DESIGN  
PATRICK JOUIN



**plié** 334

DESIGN  
STUDIO KLASS



## FIAM, cultura del vetro

Il vetro è un materiale magico ed eterno, quasi avesse un'intrinseca sacralità. Io ho accolto la sfida di questo materiale sin da quando ero ragazzo facendolo diventare praticamente una missione. Gettando le basi per un progetto che sembrava alle sue origini improbabile; far diventare il vetro in lastra un materiale protagonista nell'arredamento. Incanto e poesia, ecco quello che ancora mi trasmette il vetro. L'incanto di una materia senza tempo. La poesia è la vanità di una materia capace di riflettere ciò che ci circonda e di moltiplicare i nostri punti di vista sul reale.

## FIAM, la culture du verre

Le verre est un matériau magique et éternel, qui semble posséder un caractère sacré intrinsèque. Dès mon plus jeune âge, j'ai voulu relever le défi de ce matériau, qui est bientôt devenu pour moi une mission. J'ai ainsi jeté les bases d'un projet qui semblait au départ improbable : conférer au verre en plaque une place de premier plan dans la décoration. Magie et poésie : ce sont les deux sensations que le verre m'a toujours procurées. La magie d'une matière intemporelle. La poésie, ou la vanité d'une matière capable de refléter tout ce qui nous entoure et de multiplier à l'infini nos perspectives sur la réalité.

## FIAM, the art of glass

Glass is a magical and ever lasting material, as if it possessed an innate sacredness. I was young when I first accepted the challenge that this material represented and I set the basis for a project that initially seemed so unlikely possible: making glass become a furnishings star. Charm and poetry are still what glass conveys to me. The magic of a timeless material. Poetry is the vanity of a material capable of mirroring all that surrounds it and to multiply our perceptions of reality.

## FIAM, die Kultur edles Glases

Glas ist ein zeitlos schönes Material mit magischer Ausstrahlung. Ich habe die Herausforderung dieses geheimnisvollen Materials schon in jungen Jahren angenommen, und in gewisser Weise zu meiner Mission auserkoren. Und damit die Grundlagen für ein Projekt geschaffen das zu Beginn beinahe aussichtslos erschien - die flache Glasscheibe zu einem Protagonisten der Einrichtung zu machen. Und auch heute noch vermittelt mir das Glas Zauber und Poesie. Den Zauber einer zeitlosen Materie. Die Poesie einer Materie, die ihre und unsere Umgebung reflektiert und unsere Blickpunkte auf die Realität vervielfacht.

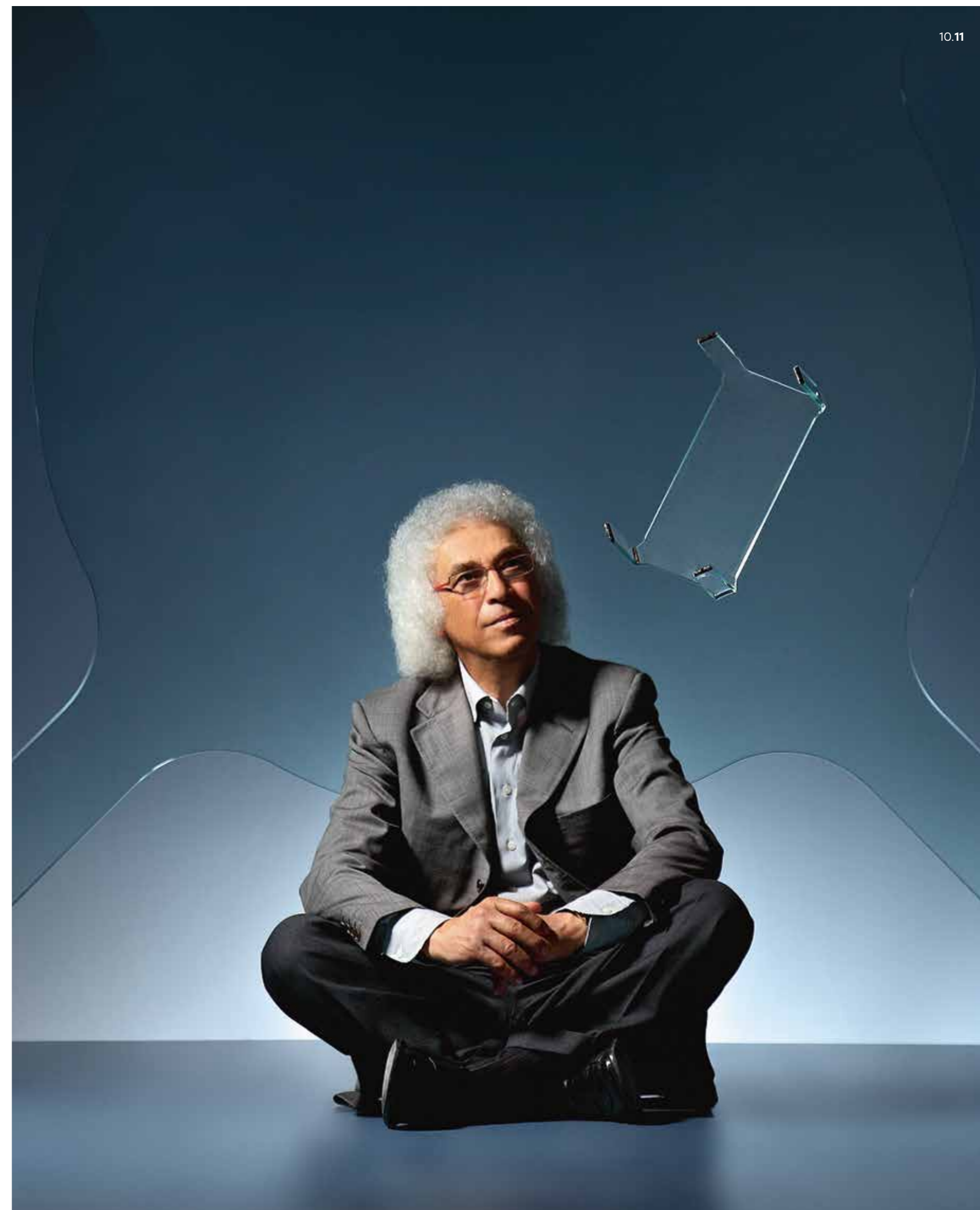



Vittorio Livi

Compasso d'Oro  
alla carrieraPremio Leonardo  
Qualità Italia 2015

## Designer e riconoscimenti

Fiam Italia è stata più volte riconosciuta a livello globale come azienda di eccellenza ed innovazione, come dimostrano i numerosi premi ricevuti nel tempo, tra gli altri, il Premio Compasso d'Oro alla carriera ed il Premio Leonardo Qualità Italia. Il Premio Compasso d'Oro è il più antico e più autorevole premio mondiale di design, istituito nel 1954 da un'idea di Gio Ponti. Fiam lo ha conseguito alla carriera nel 2001, come impresa che si è distinta con riconoscenza e prestigio in ambito progettuale, produttivo e di ricerca. Nel 2015 Il Comitato Leonardo, che da oltre venti anni riconosce e premia il talento di uomini ed imprese per dare rilevanza alle tante straordinarie eccellenze del Made in Italy, ha insignito Fiam del Premio Leonardo Qualità Italia come azienda che si è distinta per innovazione e qualità dei prodotti combinata con una forte proiezione internazionale, commerciale e produttiva.

## Designers et prix

Fiam Italia a été maintes fois reconnue mondialement pour sa vocation à l'innovation et à l'excellence, comme en témoignent les nombreux prix remportés au fil du temps et dont, entre autres, le Prix Compasso d'Oro pour l'ensemble des réalisations et le Prix Leonardo Qualità Italia. Le prix Compasso d'Oro, soit le plus ancien et le plus influent prix international de design, a été créé en 1954 par Gio Ponti. Fiam a remporté le prix pour l'ensemble des réalisations en 2001 en tant qu'entreprise s'étant distinguée dans le domaine de la conception, de la fabrication et de la recherche, se voyant adjudiquer ainsi une des plus prestigieuses marque de reconnaissance du secteur. En 2015, le Comité Leonardo, qui depuis plus de vingt ans, reconnaît et récompense le talent des hommes et des sociétés pour souligner les multiples expressions de l'excellence du Made in Italy, a décerné le Prix Leonardo Qualità Italia à Fiam en tant que une société s'étant distinguée pour son innovation et la qualité exceptionnelle des produits, de son développement commercial et de la fabrication, ainsi que pour son caractère international.

## Designers and awards

Fiam Italia has been repeatedly recognized globally as a company of excellence and innovation, as evidenced by the numerous awards received over time, among them, the Premio Compasso d'Oro (Golden Compass Award) for career and the Premio Leonardo Qualità Italia (Leonardo Award for Quality Italy). The Premio Compasso d'Oro is the oldest and most authoritative global design award, created in 1954 from an idea by Gio Ponti. Fiam has achieved the career award in 2001, as a company that has distinguished itself with gratitude and prestige in design, production, and research. In 2015, the Leonardo Committee, which has been recognizing and awarding the talent of men and companies to give relevance to the many extraordinary excellences of the Made in Italy for more than twenty years, has awarded Fiam with the Premio Leonardo Qualità Italia as a company that has distinguished itself for innovation and quality of products combined with a strong international outlook, for both commerce and production.

## Designer und Preise

Wie die zahlreichen, im Laufe der Zeit von Fiam Italia erhaltenen Preise zeigen, wurde das Unternehmen aufgrund seiner Exzellenz und Innovation mehrfach international ausgezeichnet. Zu den Preisen gehören unter anderem der Preis Compasso d'Oro alla Carriera sowie der Preis Leonardo Qualità Italia. Der Preis Compasso d'Oro ist der älteste und renommierteste Preis für Design weltweit und wurde im Jahr 1954 von Gio Ponti gestiftet. Fiam erhielt diesen Preis nach seiner Erfolge im Jahr 2001 als Unternehmen, das sich durch Anerkennung und Ansehen im Bereich Projektplanung, Produktion und Forschung auszeichnet. Das Komitee Comitato Leonardo, das seit über 20 Jahren das Talent von Menschen und Firmen honoriert und prämiert, um besonders hervorragenden italienischen Produktionen Relevanz zukommen zu lassen, zeichnete Fiam im Jahr 2015 als Unternehmen, das sich durch innovative und qualitativ hochwertige Produkte in Kombination mit einer besonders starken internationalen, kommerziellen und produktiven Position kennzeichnet, mit dem Preis Leonardo Qualità Italia aus.



Archirivolto Design



Aquilì Alberg



Bartoli Design



Cini Boeri



Simone Bonanni



Luca Casini



Valerio Cometti



Angelo Cortesi



Fabio Di Bartolomei



Marzia e Leo Dainelli



Rodolfo Dordoni



Doriana e Massimiliano Fuksas



Emmanuel Gallina





Chafik Gasm



Massimo Iosa Ghini



Dante O. Benini e Luca Gonzo



Makio Hasuike



Patrick Jouin



Setsu & Shinobu Ito



studio Klass



Danny Lane



Daniel Libeskind



Lanzavecchia + Wai



Luca Lo Bianco



Xavier Lust



Vico Magistretti



Ilaria Marelli



Enzo Mari



Francesco Mansueto



Massimo Morozzi



Matteo Nunziati



Davide Oppizzi



Satyendra Pakhalé



Ludovica + Roberto Palomba



Roberto Paoli



Lucidi Pevere



Christophe Pillet



Prospero Rasulo



Marta Laudani e Marco Romanelli



Gerussi - Sartoris



Philippe Starck



Mac Stopa



Enrico Tonucci

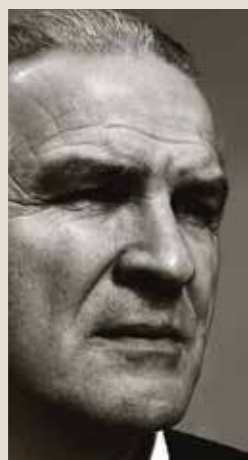

Elio Vigna



Marcel Wanders



This Weber



Helidon Xhixha

## Il vetro: un simbolo dell'ecosostenibilità del futuro

Il vetro è natura. È costituito prevalentemente di sabbia e calce. È asettico, atossico e non rilascia alcuna sostanza nociva.

Il vetro è eterno e può essere riciclato all'infinito senza scarto. FIAM Italia valorizza le virtù del vetro attraverso i suoi processi produttivi che si svolgono nel pieno rispetto dell'ambiente.

## Le verre: un symbole de l'avenir du développement durable

Le verre est naturel. Il est essentiellement composé de sable et de chaux.

Il est aseptique, atoxique et ne dégage pas de substance nocive. Le verre est éternel et peut être recyclé à l'infini sans déchet. FIAM Italia valorise les vertus du verre par des procédés de fabrication qui respectent pleinement l'environnement.

## Glass: symbol of an eco-sustainable future

Glass is nature. It consists mainly of sand and lime. It is aseptic and non-toxic and does not give off any harmful substances. Glass is eternal and can be recycled indefinitely without generating waste. FIAM Italia exploits the benefits of glass to the full through its environment-friendly production processes.

## Glas – ein Symbol für Nachhaltigkeit, Umweltfreundlichkeit und Zukunft

Glas ist ein Stück Natur. Denn es besteht vorwiegend aus Sand und Kalk.

Es ist keimfrei, ungiftig und gibt keine schädlichen Stoffe ab. Glas hält ewig und kann ohne Rückstände immer wieder recycelt werden. FIAM Italia wertet die Vorteile des Glases dank umweltfreundlicher Produktionsverfahren zusätzlich auf.





## Vetro multicolor

Ideato per consentire al vetro di assumere più colori, abbinabili tra loro e con il resto dell'arredo, un vetro con una forte personalità che lo rende protagonista, e che conferisce una grande eleganza a tutto l'ambiente.

## Verre multicolor

Conçu pour conférer au verre la possibilité de prendre plusieurs couleurs, qu'on peut associer entre elles et avec le style du reste de l'ameublement, un verre à la forte personnalité qui le rend protagoniste, et qui confère une grande élégance à tout l'environnement.

## Multicolor glass

Conceived to give several colours to the glass; to match the colors between them but at the same time with the rest of the furniture. The strong personality of this glass makes it the protagonist of the environment, giving elegance to the whole space.

## Das Bunten Glas

Entworfen, um dem Glas die Möglichkeit zu geben, mehr Farben anzunehmen, die miteinander und mit der Einrichtung gut anpassen. Ein Glas mit einer starken Persönlichkeit, das es zum Protagonisten macht, und das verleiht der ganzen Umgebung eine große Eleganz.

## DV Glass®

Nella storia del vetro si è da sempre cercato l'utilizzo di spessori molto alti, purtroppo, per questioni tecniche e dimensionali, questo desiderio non si è mai potuto realizzare. Ora, con il nostro originale prodotto, siamo in grado di produrre vetro di grandi dimensioni, alti spessori e con colorazioni miste. Una tecnica che finalmente ci permette di avere misure e colori variabili e che conferisce al vetro lavorato una forte matericità alla vista ed al tatto.

## DV Glass®

Dans l'histoire du verre, on a toujours essayé d'utiliser de grandes épaisseurs, mais malheureusement, pour des raisons techniques et de dimensions, ce désir n'a jamais pu se réaliser. Désormais, avec notre produit unique, nous sommes en mesure de produire du verre de grandes dimensions, en grandes épaisseurs et avec des colorations combinées. Une technique qui nous permet enfin d'avoir des mesures et des couleurs variables et qui confère au verre travaillé une forte présence à la vue et au toucher.

## DV Glass®

The use of big thickness in glass manufacturing processes has always been a great ambition which, unfortunately, for technical and dimensional matters, has never been reached. But now, with our original product, we are able to produce glass of great dimensions, big thickness and with mixed finishes. We came up with a technique that finally allows variations in measures and colors resulting in a strong "perceptible" design appreciable through sight and touch.

## DV Glass®

In der Geschichte des Glases wurde immer nach einer sehr hohen Stärke gesucht, leider wurde dieser Wunsch aus technischen und dimensional Gründen nie erreicht. Mit unserem Originalprodukt können wir nun ein Glas mit verschiedenen Farben und Stärke und große Dimensionen schaffen. Eine Technik, die uns endlich variable Größen und Farben ermöglicht und gibt dem bearbeiteten Glas eine starke Materialität zum Sehen und Anfassen.



## Goffratura ad alta temperatura

Grazie alle potenzialità dei nostri impianti ed all'abilità manuale dei nostri stampisti, siamo riusciti a dare al vetro un aspetto decorativo su lastre lavorate artigianalmente, ottenendo un risultato impensabile per bellezza e qualità. Sino ad oggi infatti sono sempre state prodotte lastre di vetro con goffrature minime come profondità e con produzioni fortemente industriali. Noi oggi siamo riusciti a realizzare delle lastre con decori goffrati a piacere, anche ad alto rilievo, con misure ampiamente customizzabili. Con l'impiego di speciali smalti si riescono ad aggiungere degli effetti di profondità e tridimensionalità a decori sinuosi ed eleganti, che creano un forte impatto emozionale.

## Gaufrage à haute température

Grâce aux potentialités de nos installations et à l'exécution manuelle de nos imprimeurs, nous avons réussi à donner au verre un aspect décoratif sur vitres travaillés artisanalement, en obtenant ainsi un résultat inimaginable de beauté et de qualité.

En effet, jusqu'à aujourd'hui, on a toujours produit des vitres avec des gaufrages minimales en profondeur et avec des productions fortement industrielles. Aujourd'hui, nous avons réussi à réaliser des vitres avec des décorations gaufrées à volonté, même avec fort relief, sur des mesures largement personnalisables. En utilisant des vernis particulières, on a réussi à ajouter des effets de profondeur et de tridimensionnalité à des décorations sinueuses et élégantes, qui créent un fort impact émotionnel.

## High temperature embossing

Thanks to the potentials of our equipments and the manual ability of our master glassmakers, we have succeeded in giving an ornamental look to the handcrafted glass plates achieving high-quality results. In fact, until now, glass plates have always been produced with minimal embossing and in large quantities for the industrial production. Today, we have succeeded in realizing glass panels with embossed ornaments, also in high relieves, with measures widely customizable. Using specialized glazes we are able to add effects of depth and three-dimensionality to the sinuous and elegant adornments thus creating a strong emotional impact.

## Das Gaufrieren aus Hohen Temperaturen

Dank unseren Anlagen und fähiger Handwerker, konnten wir dem Glas eine dekorative Wirkung auf die von Hand gearbeiteten Platten verleihen, was zu einem undenkbaeren Ergebnis für Schönheit und Qualität führte. Bis jetzt wurden Glasscheiben tatsächlich mit minimalen Prägungen wie Tiefe und mit stark industriellen Produktionen hergestellt. Heute sind wir in der Lage, Platten mit erhabenen Verzierungen zu schaffen, wie gewünscht, sogar im Hochrelief, mit weitgehend anpassbaren Maßen. Mit der Verwendung von speziellen Glasuren können Sie den sinusförmigen und eleganten Dekorationen Effekte der Tiefe und Dreidimensionalität hinzufügen, die eine starke emotionale Wirkung erzeugen.

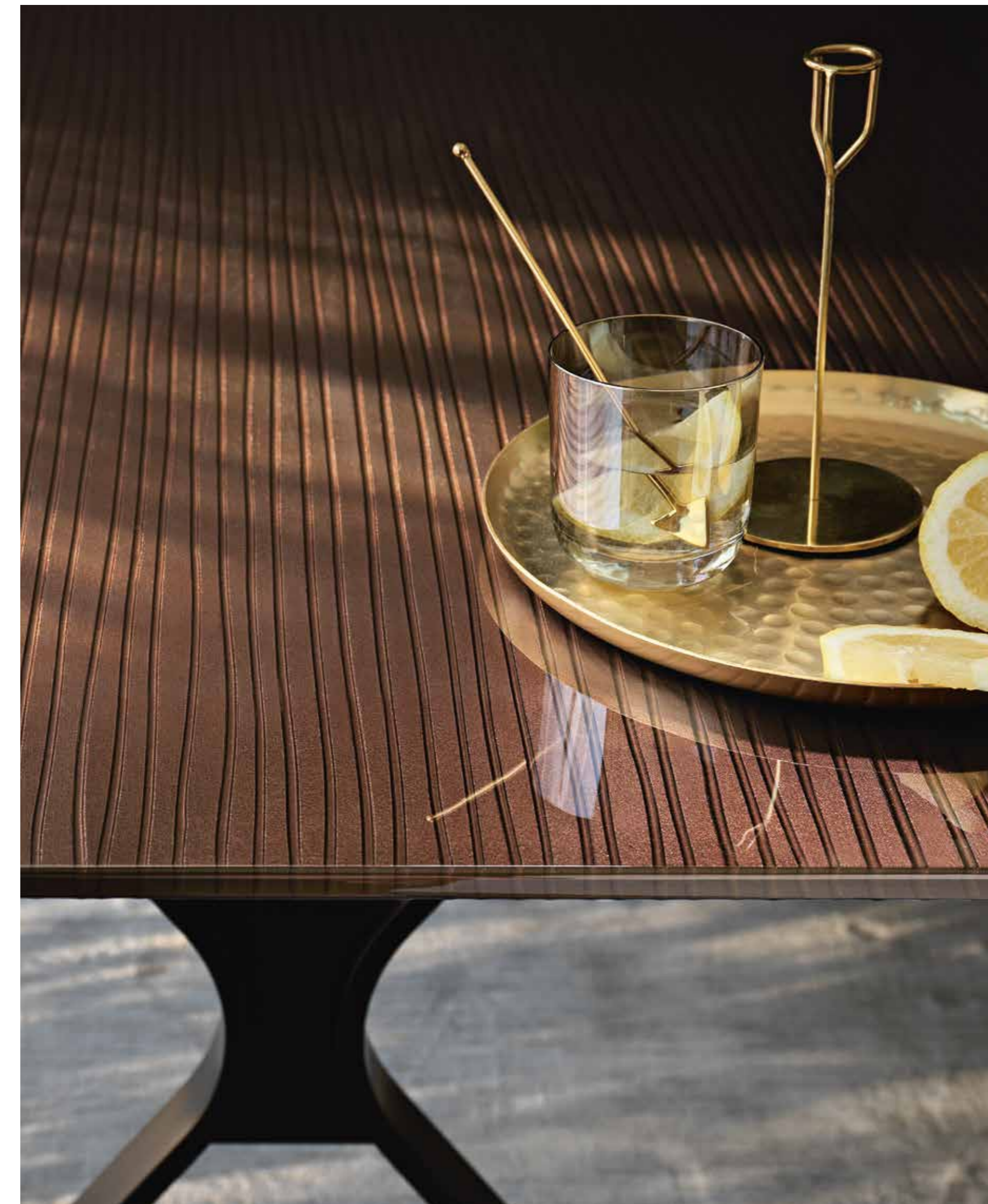

## Il vetro Magma

Il vetro Magma prende ispirazione dall'antica tradizione di colatura del vetro fuso in contenitori metallici e successiva ricottura in apposite fornaci, un processo questo molto lento ed estremamente artigianale. Fiam è riuscita a restituire l'aspetto del vetro colato di forte spessore su lastre di grandi dimensioni, grazie alla tecnologia Magma: il connubio tra una forma sinuosa e la fusione a gran fuoco su speciali refrattari ha la forza di ammorbidire il vetro, per sua natura duro e spigoloso, conferendogli l'aspetto della materia allo stato liquido. Durante la fusione, la superficie irregolare dello stampo forgia la lastra di vetro producendo un effetto grafico molto poetico in quanto casuale e mai perfettamente ripetibile.

## Le verre Magma

Le verre Magma s'inspire de l'ancienne tradition de la coulure du verre fondu dans des récipients métalliques et du recuit ultérieur dans des fours spéciaux, un processus très lent et extrêmement artisanal. Grâce à la technologie Magma, Fiam a réussi à restaurer l'aspect du verre coulé sur des grandes vitres : la combinaison entre une forme sinueuse et la fusion à feu élevé sur des réfractaires spéciaux a la force d'adoucir le verre, pour sa nature dure et droit, en lui donnant l'apparence de la matière à l'état liquide. Pendant la coulée, la surface irrégulière du moule forge la vitre en produisant un effet graphique très poétique car aléatoire et jamais parfaitement reproductible.

## Magma glass

Magma glass takes its inspiration from the ancient tradition of casting molten glass in metal containers and subsequent annealing in appropriate furnaces, a slow and extremely artisanal process. Thanks to the magma skills, Fiam has been able to give a great thickness on big dimensional glass plate: the union between wavy form and the high-temperature melted glass, for its nature hard and edgy, give a liquid aspect to the material. During the fusion, the irregular outside of the mould forges the glass plate producing a random and never the same graphic effect.

## Magma Glas

Magma Glas hat seine Inspiration von der alten Tradition des Gießens von geschmolzenem Glas in Metallbehältern und dem anschließenden Glühen in speziellen Öfen, einem sehr langsamen und äußerst handwerklichen Verfahren. Fiam ist es dank der Magma-Technologie gelungen, das Aussehen von dick gegossenem Glas auf großen Platten wiederherzustellen: die Verbindung zwischen einer gewundenen Form und dem Schmelzen bei großem Feuer auf speziellen Feuerfestmaterialien hat die Stärke, das Glas durch seine harte und eckige Beschaffenheit zu erweichen, wodurch es dem Aussehen des Materials im flüssigen Zustand verliehen wird. Während des Gießens schmiedet die unebene Oberfläche der Form die Glasplatte und erzeugt einen graphischen Effekt sehr poetisch da immer zufällig und nie perfekt wiederholbar.



# ghost

NON AVREI MAI PENSATO DI FARE UNA POLTRONA IN VETRO...  
LA MIA INIZIALE DIFFIDENZA PER UN'IDEA CHE SEMBRAVA  
IRREALE FU SUPERATA DAL DESIDERIO/SFIDA DI VEDERE  
SE FOSSE POSSIBILE CONCRETIZZARLA; E SE FIAM  
SAREBBE STATA COSÌ BRAVA DA RIUSCIRE A REALIZZARLA.

I WOULD NEVER HAVE THOUGHT OF MAKING A CHAIR FROM GLASS...  
MY INITIAL DISTRUST OF AN IDEA WHICH SEEMED QUITE UNREALISTIC  
WAS OVERCOME BY THE DESIRE TO TAKE UP THE CHALLENGE  
AND SEE WHETHER IT COULD ACTUALLY BE MADE, WHETHER FIAM  
WOULD BE CLEVER ENOUGH TO TRANSFORM THE CONCEPT INTO REALITY.

JE N'AURAIS JAMAIS PENSÉ RÉALISER UN JOUR UN FAUTEUIL EN VERRE ...  
MA MÉFIANCE INITIALE À L'ÉGARD D'UNE IDÉE QUI SEMBLAIT IRRÉELLE  
A ÉTÉ SURMONTÉE PAR LE DÉsir/LE DÉFI DE VOIR S'IL ÉTAIT POSSIBLE  
DE LA CONCRÉTISER ET SI FIAM SERAIT À LA HAUTEUR DE LA RÉALISER.

NIE HÄTTE ICH GEDACHT, DASS ICH EINES TAGES EINEN STUHL  
AUS GLAS MACHEN WÜRDE... MEIN ANFÄNGLICHES MISSTRAUEN  
GEGENÜBER EINER IDEE, DIE MIR UNREALISTISCH ERSCHIEN,  
WURDE BALD DURCH DEN WUNSCH UND DEN EHRGEIZ VERDRÄNGT,  
ZU SEHEN, OB ICH DIESE IDEE WIRKLICH UMSETZEN KANN UND OB FIAM  
ES SCHAFFEN WÜRDE, DIE VON MIR UMGESETZTE IDEE ZU REALISIEREN.

**CINI BOERI**



# ghost

DESIGN CINI BOERI

Poltrona in vetro curvato  
da 12 mm.

Monolithic chair  
in 12 mm-thick curved glass.

Fauteuil en verre cintré  
d'une seule dalle  
de verre de 12 mm.

Sessel aus gebogenem  
12 mm-starkem Glas,  
aus einer einzigen  
Glasplatte gefertigt.





atlas	144
big wave	40
coral beach	32
corner	156
epsilon	88
hype	62
kayo	166
kighi	52
LLT	116
LLT wood	124
luxor	148
magma	92
plié	136
ragno	142
ray	158
ray plus	162
sahara	152
theo	80
waves	48



TAVOLI  
TABLES  
TABLES  
TISCHE

## coral beach

DESIGN MAC STOPA

Piano in vetro fuso  
retroverniciato blu notte.  
Fused glass top,  
night blue back-painted.

260 x 120 x 65 cm  
102 3/8" x 47 1/4" x 29 1/2"

Sedia Easy Lloyd  
Easy Lloyd chair

Tavolini Lakes  
Lakes coffee tables





## coral beach

DESIGN MAC STOPA

Tavolo con base in metallo verniciato, finitura Grigio Lava opaco. Piano in vetro da 15 mm fuso a gran fuoco e temperato, disponibile trasparente o retroverniciato con tinte metallizzate.

Table with metal painted base, opaque "Lava Grey" finish. Top in 15 mm fused and tempered glass, available transparent or back-lacquered with metal shades.

Table avec piètement en métal verni, finition Gris Lave opaque. Plateau en verre en fusion et trempé de 15mm, disponible transparent ou vernie dessous avec des teintes métallisées.

Tisch mit Gestell aus lackiertem Metall in der Ausführung "Lava Grey" matt. Platte aus 15 mm aus geschmolzenem und gehärtetem Glas, erhältlich transparent oder mit metallische Farben unterlackiert.



Piano in vetro fuso trasparente.  
Transparent fused glass top.

260 x 120 x 65 cm  
102 3/8" x 47 1/4" x 29 1/2"

Sedia Plié  
Plié chair

# coral beach

DESIGN MAC STOPA

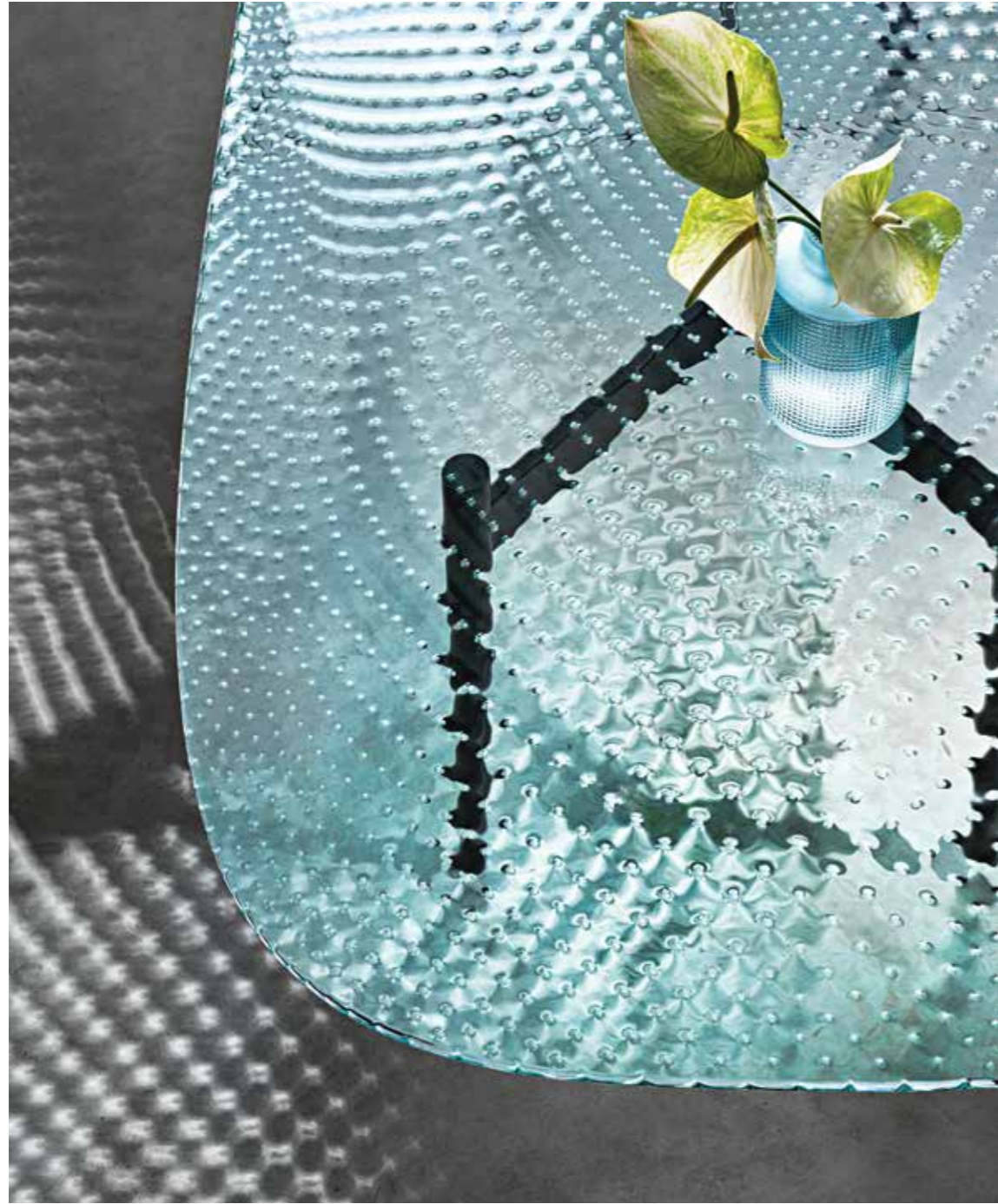

Piano in vetro fuso trasparente.  
Transparent fused glass top.

260 x 120 x 65 cm  
102 3/8" x 47 1/4" x 29 1/2"





Piano in vetro spatolato  
ecomalta nero ardesia.  
Base in DV-Glass colorato.

Ecomalta glass top,  
black slate finish.  
Colored DV-Glass base.

240 x 110 x 75 cm  
94 1/2" x 43 5/16" x 29 1/2"

Sedia Lloyd.  
Lloyd chair.

# big wave

DESIGN LUDOVICA + ROBERTO PALOMBA

Tavolo con base composta da tre, quattro o sei elementi in DV Glass da 30 mm trasparente o a strisce colorate. Piano in vetro da 15 mm trasparente retroverniciato con tinte monocromatiche, oppure ricoperto in Ecomalta, spatolatura tipo fine, oppure in legno impiallacciato noce canaletto finitura antracite opaco.

Table with base made of three, four or six separate 30 mm DV Glass elements, transparent or with colored stripes. Top made of 15 mm transparent glass, back-lacquered with monochrome color or hand-finished with Ecomalta, finer-grained texture finish, or in Canaletto walnut veneered wood, matt anthracite finish.

Table avec base composée par trois, quatre ou six éléments en DV Glass de 30 mm, transparent ou avec bandes colorées. Plateau en verre de 15 mm transparent verni dessous avec teintes monochromes ou enduit finement à la main avec Ecomalta ou en bois plaqué noyer canaletto finition anthracite opaque.

Tisch bestehend aus drei, vier oder sechs Elementen aus DV Glas Stärke 30 mm in der Ausführung transparent oder mit farbigen Streifen. 15 mm Glasplatte in den folgenden Varianten: mit monochromatischen Farben unterlackiert oder mit Ecomalta handgespachteltem Effekt auf Glas, feine Textilähnliche Bearbeitung oder in Canaletto- Nußbaum furniertem Holz in der Farbvariante mattes anthrazit.





Base in DV-Glass fumé e trasparente.  
Piano in legno noce canaletto  
finitura antracite opaco.

Smoked and transparent DV-Glass base.  
Wood top, canaletto walnut  
matt anthracite finish.

300 x 120 x 77 cm  
118 1/8" x 47 1/4" x 30 5/16"

Sedia Lloyd  
Lloyd chair





## big wave

DESIGN LUDOVICA + ROBERTO PALOMBA



# waves

DESIGN LUDOVICA + ROBERTO PALOMBA

Tavolo fisso o allungabile con base composta da due elementi in DV Glass da 30 mm trasparente o a strisce colorate. Piano in vetro da 12 mm o da 15 mm trasparente retroverniciato con tinte monocromatiche, oppure ricoperto in Ecomalta spatolata tipo fine.

Fix or extendible table with base made of two separate 30 mm DV Glass elements, transparent or with colored stripes. Top available in 12 or 15 mm transparent glass, back-lacquered with monochrome finishes, or hand-finished with Ecomalta, finer-grained texture finish.

Table fixe ou à rallonges avec base composée par deux éléments en DV Glass de 30 mm, transparent ou avec bandes colorées. Plateau en verre de 12 ou 15 mm transparent verni dessous avec teintes monochromes, ou enduit finement à la main avec Ecomalta.

Tisch oder ausziehbarer Tisch mit Untergestell bestehend aus zwei Elementen aus DV Glass, Stärke 30 mm, in der Ausführung transparent oder mit farbigen Streifen. 12 mm oder 15 mm Glasplatte in den folgenden Varianten: mit monochromatischen Farben unterlackiert oder mit Ecomalta handgespachteltem Effekt auf Glas, feine Textilähnliche Bearbeitungstextilähnlichen Bearbeitung.

## waves

DESIGN LUDOVICA + ROBERTO PALOMBA

Piano in vetro retroverniciato  
marrone testa di moro.  
Base in DV-Glass colorato.  
Dark brown back-painted glass top.  
DV-Glass colored base.  
200 (300) x 100 x 75 cm  
78 3/4" (118 1/8") x 39 3/8" x 29 1/2"





# kighi

DESIGN SETSU & SHINOBU ITO

Tavolo con base composta da 7 elementi in metallo verniciato, finitura Terra Bruciata o Grigio Platino. Piano in vetro da 15 mm temperato, disponibile nelle seguenti varianti: vetro trasparente retroverniciato con tinte metallizzate; vetro acidato retroverniciato con tinte metallizzate; vetro fuso retroverniciato con tinte metallizzate.

Table with base made of seven lacquered metal elements, available in "Burned Earth" and "Platinum Grey" finishes. Top in 15 tempered glass, available in the following finishes: transparent back-painted glass with metal shades, etched back-painted glass with metal shade, fused back-painted glass with metal shades.

Table avec base composée de 7 éléments en métal verni, finition Terre Brûlée ou Gris Platine. Plateau en verre trempé de 15 mm, disponible dans les variantes suivantes : verre transparent verni dessous avec des teintes métallisées ; verre dépoli verni dessous avec des teintes métallisées ; verre en fusion verni dessous avec des teintes métallisées.

Tisch mit Sockel aus sieben lackierten Metallelementen in „verbranntem Erdfarbe“ oder platingrau Ausführung. Platte aus 15 mm gehärtetem Glas, in den folgenden Varianten erhältlich: transparentes oder geätztes oder geschmolzenes Glas mit metallisierten Farben unterlackiert.



Piano in vetro fuso, finitura grigio lava.  
Base in metallo, finitura grigio platino.  
Fused glass top, lava grey finish.  
Metal base, platinum grey finish.

240 x 110 x 75 cm  
94 1/2" x 43 5/16" x 29 1/2"

Sedia **Kamy**  
Kamy chair

# kighi

DESIGN SETSU & SHINOBU ITO

Piano in vetro fuso, finitura grigio lava.  
Base in metallo, finitura grigio platino.

Fused glass top, lava grey finish.  
Metal base, platinum grey finish.

240 x 110 x 75 cm  
94 1/2" x 43 5/16" x 29 1/2"





Piano in vetro fuso,  
finitura marrone metallizzato.  
Base in metallo,  
finitura terra bruciata.  
Fused glass top,  
metallic brown finish.  
Metal base, burned earth finish.

240 x 110 x 75 cm  
94 1/2" x 43 5/16" x 29 1/2"

Sedia Kamy  
Kamy chair

# kighi

DESIGN SETSU & SHINOBU ITO



Piano in vetro fuso,  
finitura marrone metallizzato.  
Base in metallo, finitura terra bruciata.  
Fused glass top, metallic brown finish.  
Metal base, burned earth finish.

240 x 110 x 75 cm  
94 1/2" x 43 5/16" x 29 1/2"

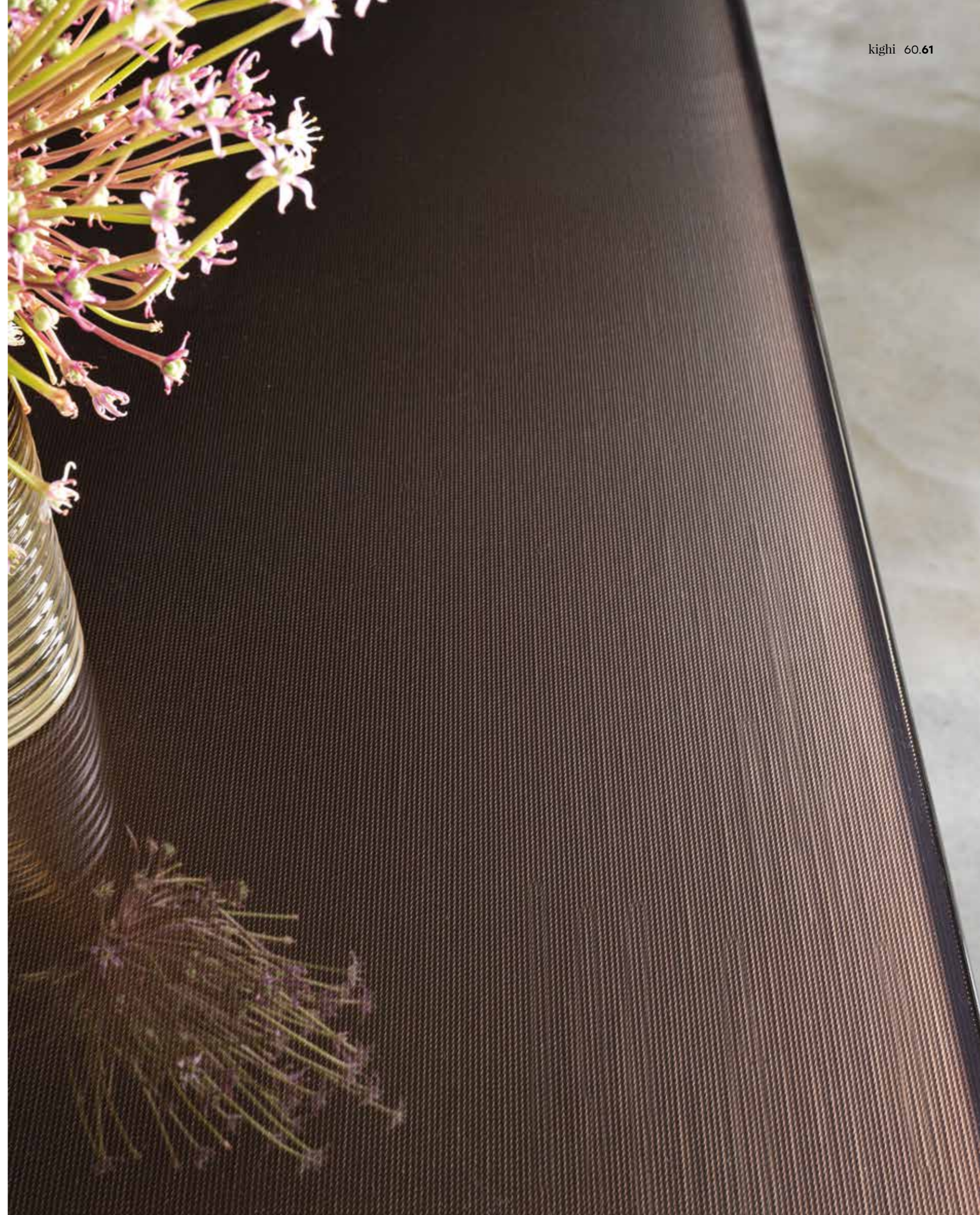





# hype

DESIGN STUDIO KLASS

Tavolo fisso o allungabile con base in metallo verniciato, finitura "Grigio Lava". Piano in vetro da 12 mm o da 15 mm fuso e retroverniciato con tinte metallizzate, oppure in vetro trasparente o extralight retroverniciato con tinte monocromatiche o con tinta speciale effetto materico.

Fix or extendible table with metal painted base, "Lava Grey" finish. Top available in 12 or 15 mm high temperature melted glass, back-lacquered with metal shades, or transparent or extralight glass back-lacquered with monochrome shade or with a textured effect.

Table fixe ou à rallonges avec base en métal verni, finition « Gris Lave ». Plateau en verre en fusion de 12 ou 15 mm verni dessous avec teintes métallisées ou en verre transparent ou extralight verni dessous avec teintes monochromes ou avec une peinture spéciale effet matière.

Tisch oder ausziehbarer tisch mit Untergestell aus lackiertem Metall in der Farbe "Lavagrau". 12 mm oder 15mm Glasplatte in den folgenden Ausführungen erhältlich: \_ geschmolzenes Glas mit metallisierten Farben unterlackiert \_ transparentes oder extralight Glas mit monochromatischen Farben oder mit einer Farbe aus materischem Effekt.

Piano in vetro fuso finitura Grigio Lava.  
Fused glass top, Lava Grey finish.

240 x 110 x 75 cm  
94 1/2" x 43 5/16" x 29 1/2"

Sedia Lloyd.  
Lloyd chair.





hype

DESIGN STUDIO KLASS

Piano in vetro fuso finitura Grigio Lava.  
Fused glass top, Lava Grey finish.

240 x 110 x 75 cm  
94 1/2" x 43 5/16" x 29 1/2"

Sedia Lloyd.  
Lloyd chair.

Piano in vetro fuso,  
finitura marrone ramato.  
Fused glass top,  
cooper brown finish.  
240 x 110 x 75 cm  
94 1/2" x 43 5/16" x 29 1/2"



hype

DESIGN STUDIO KLASS

Piano in vetro fuso finitura Grigio Lava.  
Fused glass top, Lava Grey finish.

240 x 110 x 75 cm  
94 1/2" x 43 5/16" x 29 1/2"

Sedia Lloyd.  
Lloyd chair.





Piano in vetro extralight  
acidato retroverniciato  
piombo satinato.  
Extralight glass top,  
etched and back painted,  
glazed lead finish.  
200 (300) x 100 x 75 cm  
78 3/4" (118 1/8") x 39 3/8" x 29 1/2"

Sedia **Pliè**  
Pliè chair



hype  
DESIGN STUDIO KLASS





Piano in vetro extralight acidato  
retroverniciato piombo satinato.

Extralight glass top, etched  
and back painted, glazed lead finish.

200 (300) x 100 x 75 cm  
78 3/4" (118 1/8") x 39 3/8" x 29 1/2"

Sedia Plié.  
Plié chair.





Piano in vetro retroverniciato  
marrone testa di moro.  
Back-painted glass top,  
dark brown finish.

200 (300) x 100 x 75 cm  
78 3/4" (118 1/8") x 39 3/8" x 29 1/2"

Sedia Kamy.  
Kamy chair.

Piano in vetro acidato,  
retroverniciato  
marrone metallizzato.  
Base in vetro fuso a righe,  
finitura fumé e bronzo.

Acid-etched glass top,  
metallic brown back-painted.  
Striped fused glass base,  
smoked and bronze finish.

240 x 110 x 75 cm  
94 1/2" x 43 5/8" x 29 1/2"

Sedia Easy Lloyd  
Easy Lloyd chair





## theo

DESIGN SIMONE BONANNI

Tavolo fisso o allungabile con base composta da telaio in metallo verniciato, finitura nero opaco, sul quale sono applicati due vetri da 6 mm fusi ad alta temperatura e temperati, disponibili con texture a righe o con texture goffrata. Piano in vetro da 12 o 15 mm temperato, disponibile nelle seguenti varianti: vetro retroverniciato con tinte monocromatiche; vetro acidato retroverniciato con tinte metallizzate; vetro ricoperto in Ecomalta, spatolatura tipo fine.

Fixed or extendible table with metal painted base, opaque black finish, where two 6 mm thick fused and tempered glasses are placed, available with striped texture or with embossed texture. Top in 12 or 15 mm tempered glass available in: back-lacquered glass with monochrome shade; acid-etched and back-lacquered glass with metal shades; glass hand-finished with Ecomalta, finer-grained texture finish.

Table fixe ou à rallonges avec piètement composé d'un cadre en métal verni, finition noir opaque, sur lequel sont appliquées deux plaques de verre en fusion et trempé de 6 mm, disponibles avec texture à rayures ou gaufrée. Plateau en verre trempé de 12 ou 15 mm disponible dans les variantes suivantes : verre transparent verni dessous avec des teintes monochromes; verre transparent dépoli verni dessous avec des teintes métallisées; verre transparent enduit finement à la main avec Ecomalta.

Tisch oder ausziehbarer Tisch mit lackiertem Metallgestell in dem 2 geschmolzene, gehärtete Gläser (6 mm) eingesetzt sind, mit Streifen-Dekor oder mit gaufriertem Dekor. Platte aus 12 oder 15 mm gehärtetem Glas, in den folgenden Ausführungen: transparentes Glas mit monochromatischen Farben unterlackiert, transparentes geätztes Glas mit Metallfarben unterlackiert oder transparentes Glas mit Ecomalta bespachtelt zu einer feinen Textilähnlichen Bearbeitung.

# theo

DESIGN SIMONE BONANNI

Piano in vetro acidato,  
retroverniciato grigio titanio.  
Base in vetro fuso goffrato,  
finitura ambra e rosa antico.

Acid-etched glass top,  
titanium grey back-painted.  
Embossed fused glass base,  
amber and antique rose finish.

130 (230) x 130 x 75 cm  
51 3/16" (90 9/16") x 51 3/16" x 29 1/2"

Sedia **Magma**  
Magma chair



theo

DESIGN SIMONE BONANNI



theo - 86.87



# epsylon

DESIGN FABIO DI BARTOLOMEI



Piano in vetro bronzo.  
Base finitura ottone brunito.  
Bronze glass top.  
Burnished brass finish legs.  
Ø 120 x 75 cm  
Ø 47 1/2 x 29 1/2"





## epsylon

DESIGN FABIO DI BARTOLOMEI

Tavolo con piano in vetro trasparente, extralight, o bronzo da 10 mm temperato. Struttura in acciaio finitura cromato oppure ottone brunito effetto nuvolato. Piastre di fissaggio in acciaio inox o in ottone. Il tavolo Epsilon è disponibile anche con piani su misura, diametro da 90 a 140 cm.

Table with 10 mm-thick tempered transparent, extralight or bronze glass top. Chromed or burnished brass finish legs; stainless steel or brass fixing plates. The Epsilon table is also available with customized top, diameter from 90 cm to 140 cm.

Table avec plateau en verre trempé de 10 mm, transparent ou en verre extralight ou en verre bronze. Pieds en acier chromé ou finition laiton bruni de 10 mm, plaques de fixation en acier inoxydable ou en laiton. La table Epsilon est également disponible avec de plateau sur mesure, diamètre de 90 à 140 cm.

Tisch mit Platte aus 10 mm gehärtetem Glas in den folgenden Ausführungen erhältlich: transparentes Glas, extralight Glas oder Bronzeglas. Beine aus verchromtem oder getöntem Messing, Befestigungsplättchen aus Edelstahl oder aus Messing. Auch mit maßgefertigter Platte erhältlich, Durchmesser von 90 bis 140 cm.

Piano in vetro trasparente. Base in metallo cromato. Transparent glass top. Chromed finish metal legs.

Ø 140 x 75 cm  
Ø 55 1/8 x 29 1/2"





Piano finitura fumo.  
Base finitura rovere tinto grigio.  
Smoke gray finish glass top.  
Gray oak finish base.

160 x 160 x 75 cm  
62" x 62" x 29 1/2"

Sedia Magma.  
Magma chair.



# magma

DESIGN PATRICK JOUIN

Tavolo con piano in vetro da 15 mm fuso a gran fuoco e temperato, disponibile nelle tinte trasparenti Fumo, Blu, Ambra o Naturale effetto satinato. Struttura in legno massello disponibile nelle finiture rovere naturale o tinto grigio.

Table with 15 mm fused and tempered glass top, available in Smoke grey, Blue, Amber or Natural satin finish. Solid wood structure available in natural or grey oak finish.

Table avec plateau en verre en fusion de 15 mm trempé, disponible dans les teintes transparentes Fumées, Bleues ou Naturel effet satiné. Structure en bois massif de chêne disponible dans les finitions naturelle ou de couleur grise.

Tisch mit Platte aus 15 mm geschmolzenem und gehärtetem Glas in den folgenden Ausführungen erhältlich: Rauch, Blau, Bernstein oder transparent mit satiniertem Effekt. Untergestell aus massivem Eichenholz in den folgenden Ausführungen erhältlich: Natur - oder Grau-gefärbt.

Piano finitura fumo.  
Base finitura rovere tinto grigio.

Smoke grey finish glass top.  
Grey finish oak base.

160 x 160 x 75 cm  
62" x 62" x 29 1/2"

Sedia Magma  
Magma chair



magma  
DESIGN PATRICK JOUIN





Piano finitura ambra.  
Base finitura rovere tinto grigio.

Amber finish glass top.  
Grey oak finish base.

240 x 106 x 75 cm  
94 1/2" x 41 3/4" x 29 1/2"

Sedia Plié.  
Plié chair.

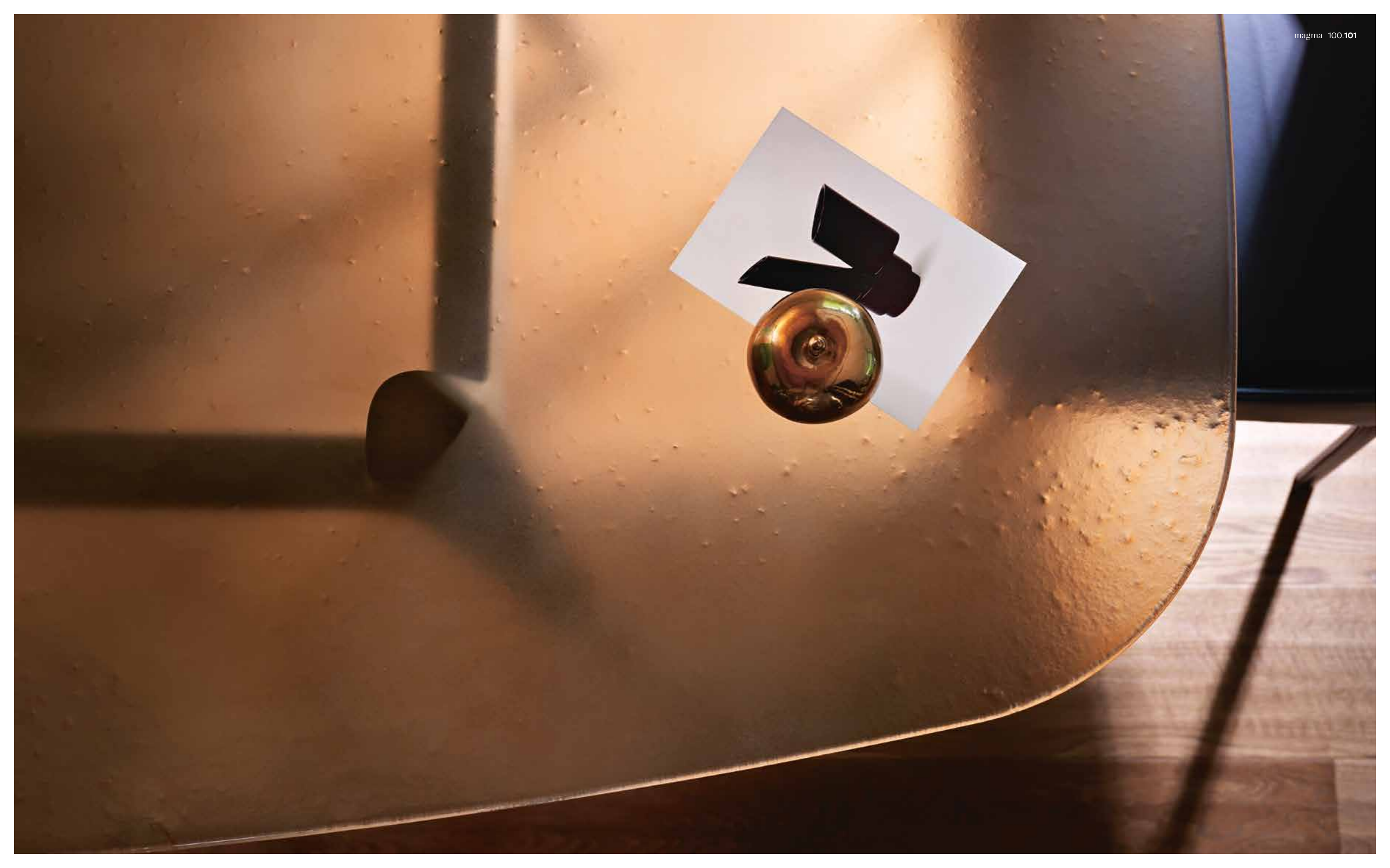

# magma

DESIGN PATRICK JOUIN

Piano finitura ambra.  
Base finitura rovere tinto grigio.

Amber finish glass top.  
Grey oak finish base.

240 x 106 x 75 cm  
94 1/2" x 41 3/4" x 29 1/2"

Sedia Plié.  
Plié chair.

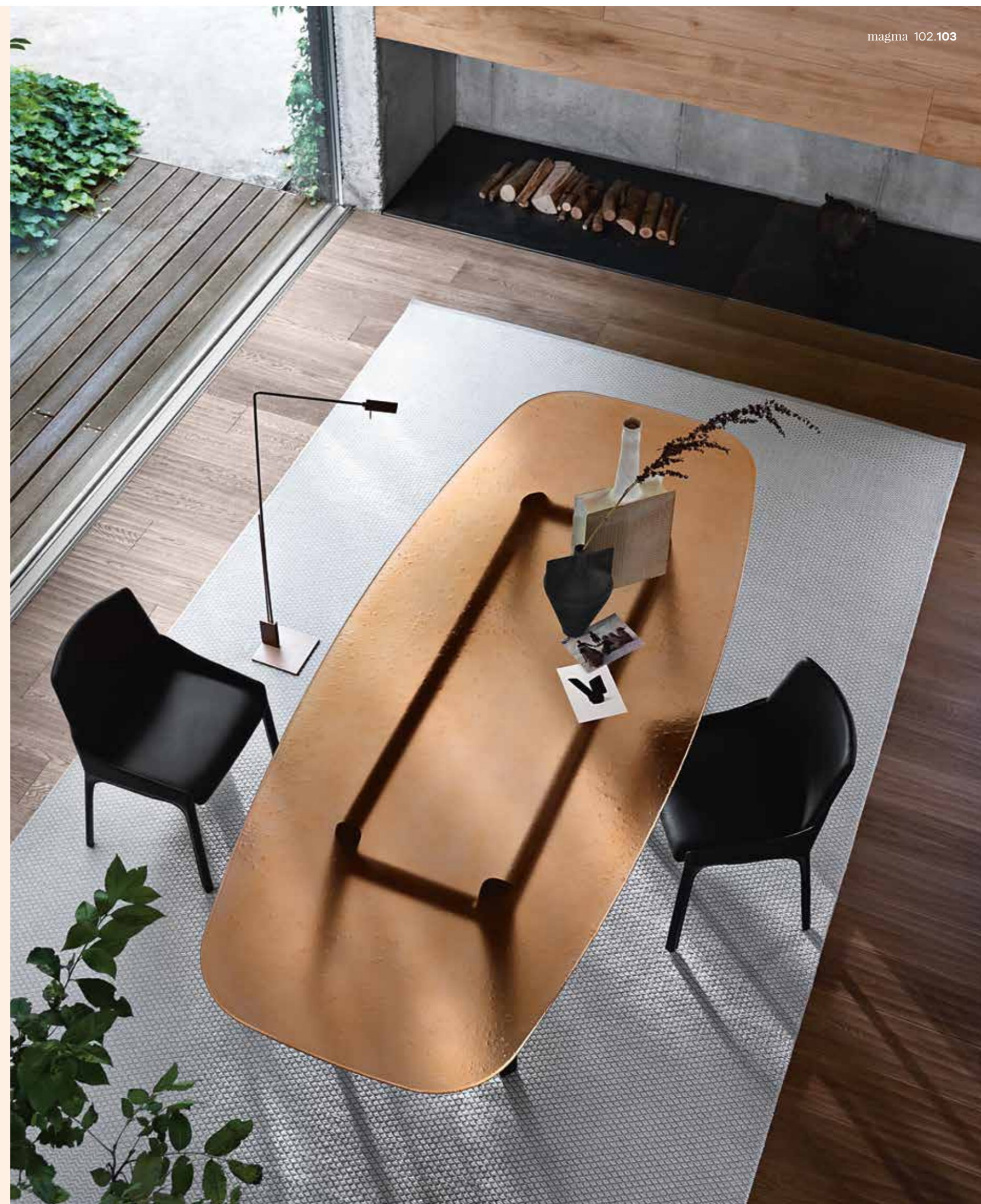



Piano finitura blu.  
Base finitura rovere naturale.  
Blue finish glass top.  
Natural oak finish base.

240 x 106 x 75 cm  
94 1/2" x 41 3/4" x 29 1/2"

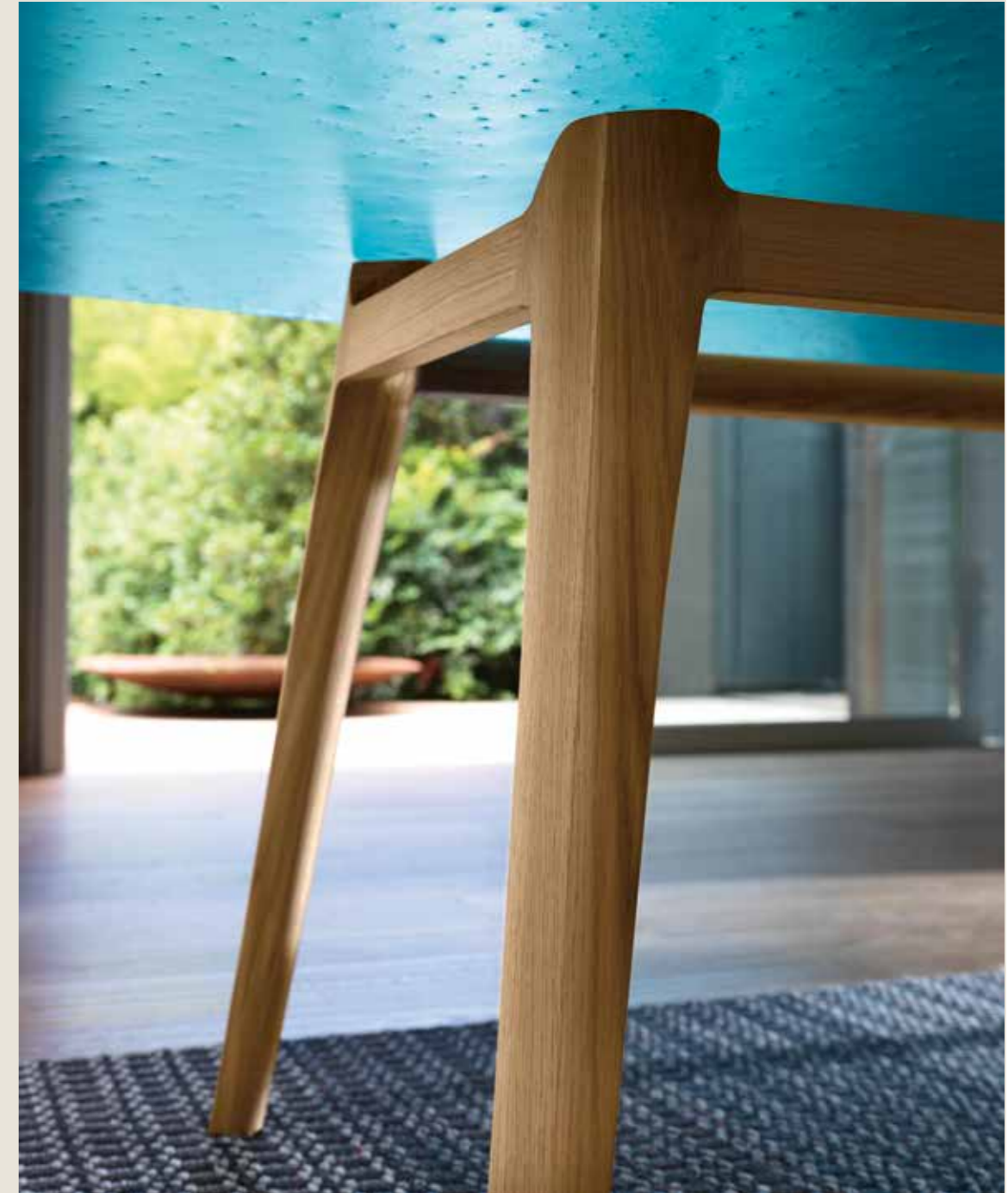



Piano finitura ecomalta tortora.  
Base in vetro extralight fuso.

Dove grey ecomalta finish top.  
Fused extralight glass base.

146 (236) x 146 x 75 cm  
57 1/2" (93") x 57 1/2" x 29 1/2"

Sedia Plié.  
Plié chair.





## rime

BARTOLI DESIGN

Tavolo fisso o allungabile con piano in vetro temperato da 12 o 15 mm. Disponibile in diverse finiture: vetro acidato o liscio, retroverniciato; vetro trasparente ricoperto in Ecomalta, spatolatura tipo fine. Basamento composto da elementi in vetro extralight da 15 mm fuso a gran fuoco.

Fix or extendible table with 12 mm or 15 mm tempered glass top. Following finishes available: back-painted glass or back painted acid etched glass or glass hand finished with Ecomalta, finer -grained texture finish. 15mm extralight fused glass base.

Table fixe ou à rallonges avec plateau en verre trempé de 12 mm ou 15 mm. Différentes finitions disponibles : verre laqué au dos ou verre dépoli laqué au dos ou verre enduit à la main avec Ecomalta effet matière. Finition Texture au grain fin. Base composée d'éléments en verre extra light en fusion de 15 mm.

Tisch oder ausziehbarer Tisch mit gehärteter Glasplatte, Stärke 12 mm oder 15 mm. Platte in den folgenden Ausführungen erhältlich: lackiertes Glas oder geätztes lackiertes Glas oder mit Ecomalta handgespachteltem Effekt auf Glas. Feine Textilähnliche Bearbeitung. Untergestell aus 15 mm geschmolzenem extra light Glas.



Piano in vetro acidato  
retroverniciato nero.  
Base in vetro extralight fuso.

Black back-painted  
and acid-etched glass.  
Fused extralight glass base.

146 (236) x 146 x 75 cm  
57 1/2" (93") x 57 1/2" x 29 1/2"



Piano in vetro acidato  
retroverniciato nero.  
Base in vetro extralight fuso.

Black back-painted  
and acid-etched glass.  
Fused extralight glass base.

146 (236) x 146 x 75 cm  
57 1/2" (93") x 57 1/2" x 29 1/2"

Sedia Plié.  
Plié chair.



## LLT

DESIGN BY DANTE O.BENINI E LUCA GONZO

Tavolo in vetro extralight,  
spessore vetro 19 mm.  
Table in extralight glass,  
glass thickness 19 mm.

240 x 100 x 72 cm  
94 1/2" x 39 3/8" x 28 3/8"

Sedia Plié  
Plié chair

# LLT

DESIGN BY DANTE O. BENINI E LUCA GONZO

Tavolo con piano in vetro trasparente o extralight da 15 o 19 mm con bisellatura su due lati corti, struttura gambe in vetro trasparente o extralight saldato da 15 o 19 mm con bisellatura da 30 mm sul bordo. Particolari di fissaggio in acciaio inox. Il tavolo LLT prevede una base a due o tre gambe a seconda della lunghezza del piano; gli stessi sono disponibili anche a misura fino a 360x100 cm.

Table composed of a 15 or 19 mm thick transparent or extralight glass top with bevelled edges on the two shorter sides and of a base in 15 or 19 mm thick transparent or extralight welded glass with 30 mm bevelled edge. Fastening elements in stainless steel. The Table LLT can be fitted with two or three bases depending upon the top length. LLT table is also available with custom-sized top up to 360x100 cm.

Table se composant d'un plateau en verre transparent ou extralight de 15 ou 19 mm avec biseautage sur les deux côtés courts et d'un piétement en verre transparent ou extralight soudé, épaisseur 15 ou 19 mm, avec bords biseautés. Éléments de fixation en acier inoxydable. Le piétement se fait de deux, trois pieds dépendant de la longueur du plateau. Egalement disponible avec plateau sur mesure jusqu'à 360x100 cm.

Tisch mit Platte aus transparentem oder extralight 15 oder 19 mm starkem Glas, Facettenschliff auf den zwei kürzeren Seiten. Untergestell aus transparentem oder extralight 15 oder 19 mm starkem verschweisstem Glas, 30 mm Facettenschliff auf den Kanten. Verbindungselemente aus Edelstahl. Der Tisch kann mit zwei bzw. drei Beinen ausgerüstet werden, abhängig von der Plattelänge: Auch mit Maßgefertigter Platte erhältlich bis max. 360x100 cm.

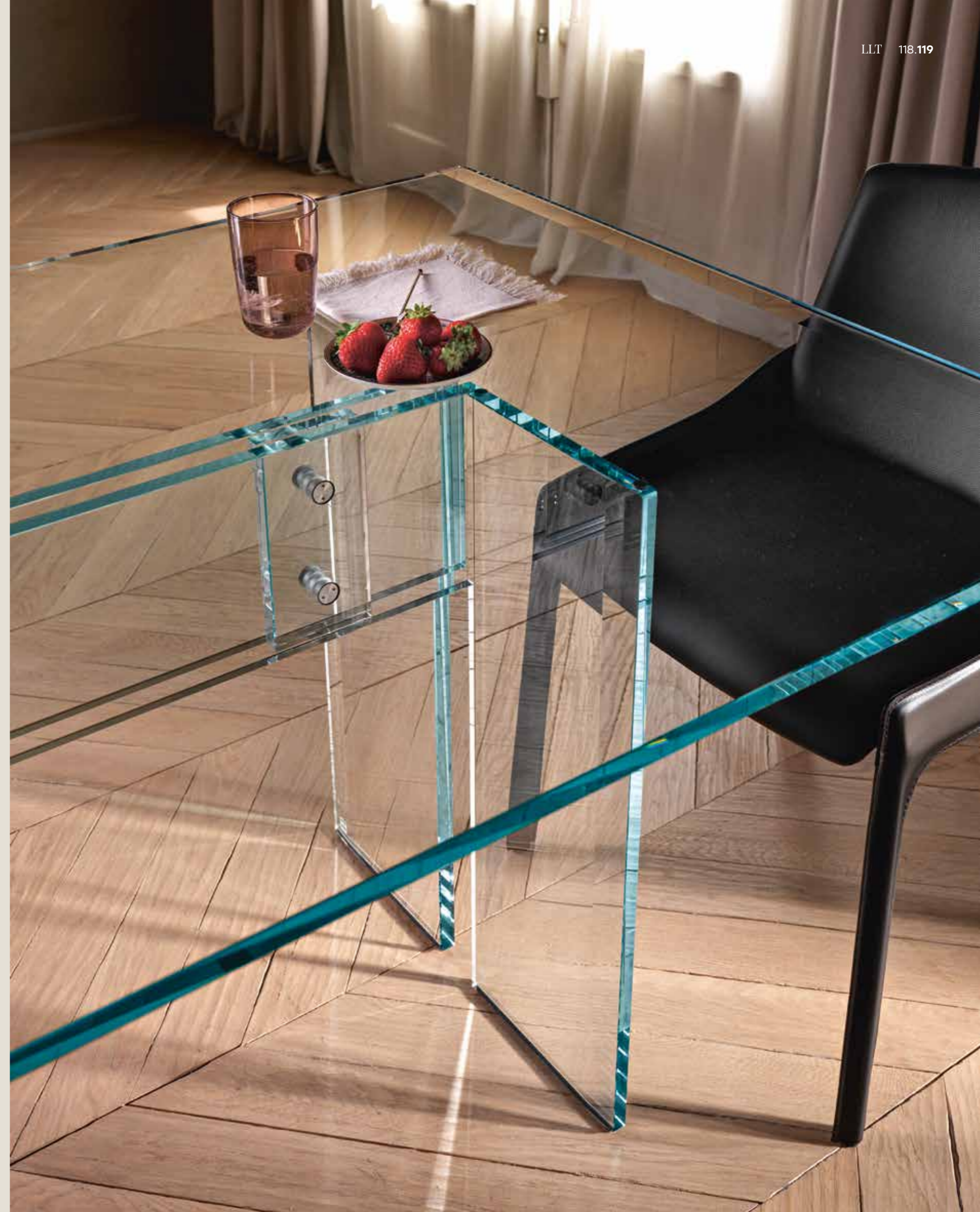

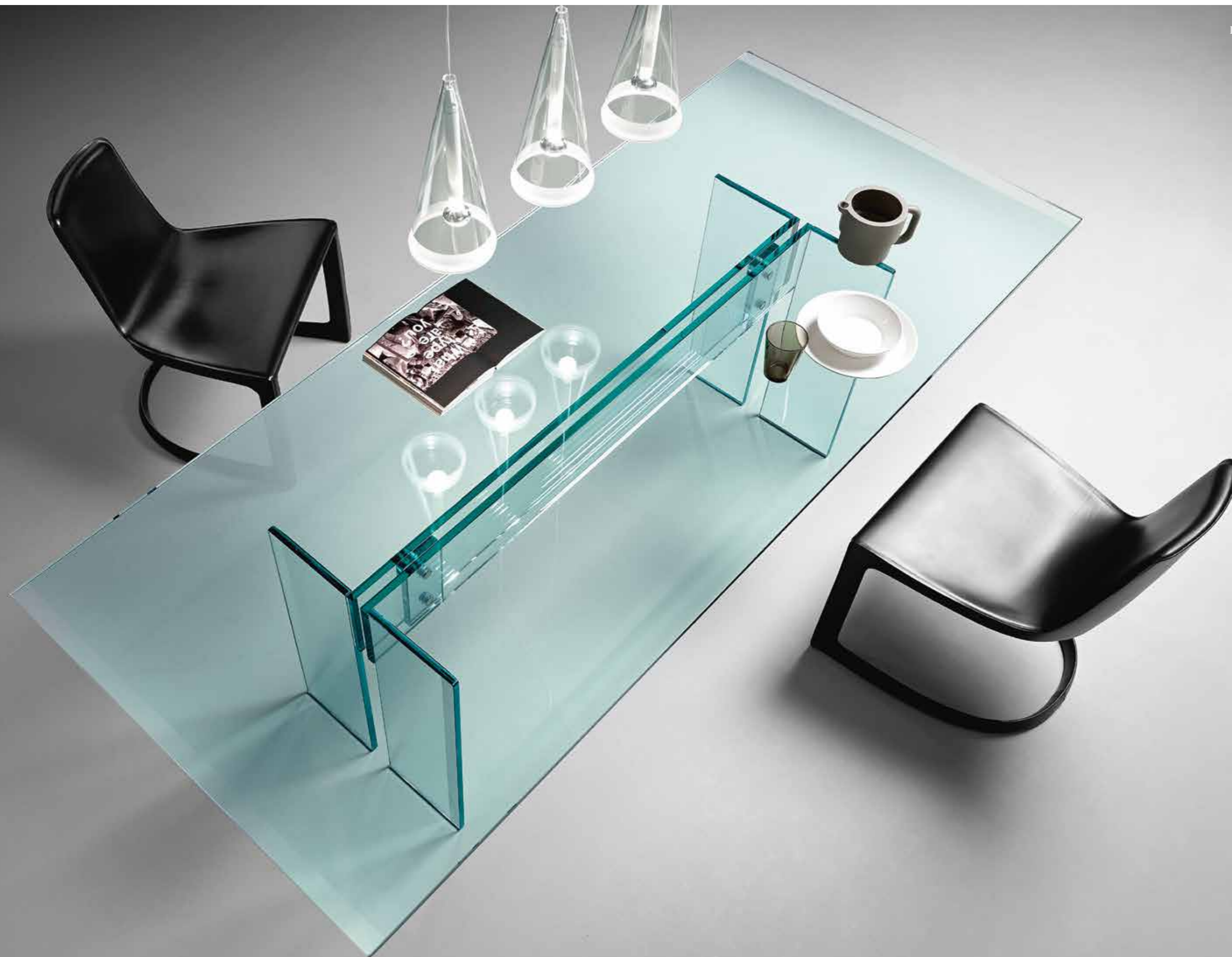

Tavolo in vetro trasparente,  
spessore vetro 19 mm.  
Table in transparent glass,  
glass thickness 19 mm.

240 x 100 x 72 cm  
94 1/2" x 39 3/8" x 28 3/8"



Tavolo in vetro trasparente,  
spessore vetro 19 mm.  
Table in transparent glass,  
glass thickness 19 mm.

300 x 100 x 72 cm  
118 1/8" x 39 3/8" x 28 3/8"



Tavolo con piano in legno finitura noce canaletto,  
base in vetro extralight.  
Table with canaletto walnut finish wood top,  
extralight glass base.

240 x 100 x 74 cm  
94 1/2" x 39 3/8" x 29 1/8"

Sedia Callas  
Callas chair



## LLT wood

DESIGN DANTE O. BENINI E LUCA GONZO

Tavolo con piano in legno multistrato marino da 40 mm impiallacciato noce canaletto, rovere "old" o rovere termotrattato, oppure in legno spatolato a mano con Ecomalta ad effetto materico, disponibile in diversi colori: Argilla, Fango M25, Calce M42. Spatolatura tipo materica. Struttura in vetro trasparente o extralight stratificato da 30 mm e gambe in vetro trasparente o extralight da 19 mm.

Table with top in 40 mm multilayered marine plywood veneered, canaletto walnut, "old style" oak finish or heat-treated oak finish, or in wood hand-finished with Ecomalta for textured effect, available in various colours: Clay brown, Mud brown M25, Lime grey M42. Rough texture finish. Structure in 30 mm layered glass, transparent or extralight and legs in 19 mm transparent or extralight glass.

Table avec plateau en bois multiplis marine 40 mm, plaqué noyer noir, chêne vieilli ou chêne traité thermiquement ou en bois enduit à la main avec Ecomalta - effet matière, disponible dans différentes couleurs: Argile, Boue M25, Chaux M42. Finition texture irrégulière. Structure en verre transparent ou extralight feuilleté de 30 mm et pieds en verre transparent ou extralight de 19 mm.

Tisch mit Platte aus 40 mm Multiplex-Holz in den folgenden Ausführungen erhältlich: Nussbaumfurnier, Eichenholz furnier aus alten Eichebalken, Eichenholz furnier wärmebehandelt oder mit Ecomalta, handgespachteltem Effekt auf Holz. Ausführungen Ecomalta: Tonbraun, Lehm Braun M25, Kalk M42. Textilhähnliche Bearbeitung. Struktur aus 30 mm transparentem oder extralight Verbundglas. Beine aus 19 mm transparentem oder extralight Glas.

Tavolo con piano in legno finitura noce canaletto, base in vetro extralight.  
Table with canaletto walnut finish wood top, extralight glass base.  
240 x 100 x 74 cm  
94 1/2" x 39 3/8" x 29 1/8"

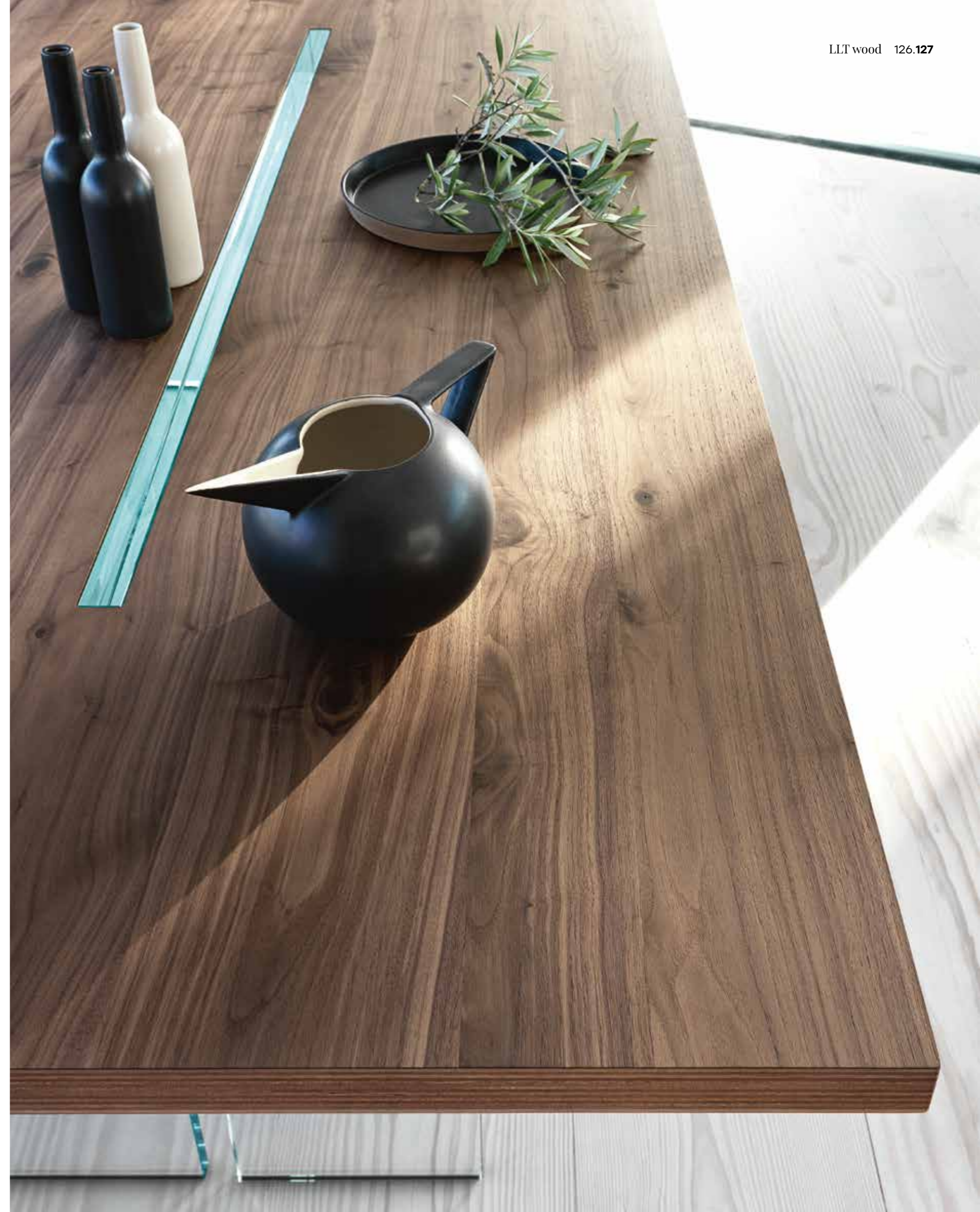



Tavolo con piano in legno  
finitura rovere "Old",  
base in vetro extralight.  
Table with "Old Style" oak  
finish wood top,  
extralight glass base.

240 x 100 x 74 cm  
94 1/2" x 39 3/8" x 29 1/8"



## LLT wood

DESIGN DANTE O. BENINI E LUCA GONZO

Tavolo con piano in legno  
finitura rovere "Old",  
base in vetro extralight.  
Table with "Old Style" oak  
finish wood top,  
extralight glass base.

240 x 100 x 74 cm  
94 1/2" x 39 3/8" x 29 1/8"



Piano finitura ecomalta argilla.  
Base in vetro extralight.  
Clay brown ecomalta finish top.  
Extralight glass base.

240 x 100 x 74 cm  
94 1/2" x 39 3/8" x 29 1/8"



## LLT wood

DESIGN DANTE O. BENINI E LUCA GONZO

Piano finitura ecomalta argilla.  
Base in vetro extralight.  
Clay brown ecomalta finish top.  
Extralight glass base.

240 x 100 x 74 cm  
94 1/2" x 39 3/8" x 29 1/8"

# plié

DESIGN STUDIO KLASS

Tavolo composto da due basi in vetro fumè sagomato e curvato da 12 mm; piano disponibile in legno impiallacciato finitura rovere termotrattato, oppure in legno spatolato a mano con Ecomalta ad effetto materico, colore Argilla. Spatolatura tipo materica.

Table consisting of two 12 mm shaped and curved smoked glass bases; top available in veneered wood with heat-treated oak, or in wood hand-finished with Ecomalta for textured effect, clay colour. Rough texture finish.

Table composée de deux bases en verre fumé, façonné et cintré de 12 mm; plateau disponible en bois plaqué finition chêne thermotraité ou en bois enduit à la main avec Ecomalta avec effet matière couleur Argile. Finition texture irrégulière.

Tisch bestehend aus 2 geformten und gebogenen Basiselementen aus Rauchglas, Stärke 12 mm. Tischplatte aus furniertem Holz in den folgenden Ausführungen erhältlich: Holz wärmebehandelte Eiche oder mit Ecomalta handgespachteltem Effekt auf Holz, Lehmfarbe, textilähnliche Bearbeitung, unregelmäßig.

Piano finitura ecomalta argilla.  
Base vetro fumè.

Clay brown ecomalta finish top.  
Smoked glass base.

240 x 100 x 74 cm  
94 1/2" x 39 3/8" x 29 1/8"



plié

DESIGN STUDIO KLASS



Piano in legno finitura rovere termotrattato.  
Base in vetro fumé.  
Heat-treated oak-finish wood top.  
Smoked glass base.  
240 x 100 x 75 cm  
94 1/2" x 39 3/8" x 29 1/2"

Collezione Plié (tavolo, madia, sedie).  
Plié collection (table, cupboard, chairs).

# plié

DESIGN STUDIO KLASS

Tavolo composto da due basi in vetro extralight sagomato e curvato da 12 mm; piano in vetro extralight da 15 mm.

Table consisting of two 12 mm shaped and curved extralight glass bases; top in extralight glass, 15 mm thick.

Table composée de deux bases en verre extralight, façonné et cintré de 12 mm ; plateau en verre extralight de 15 mm.

Tisch bestehend aus 2 geformten und gebogenen Basiselementen aus Extralight Glas, Stärke 12 mm. Tischplatte aus extra light Glas, Stärke 15mm.

Tavolo in vetro extralight con piano sagomato.  
Table in extralight glass with shaped top.

200 x 100 x 75 cm  
78 3/4" x 39 3/8" x 29 1/2"

Sedie **Bacall**.  
Bacall chairs.





## ragno

DESIGN VITTORIO LIVI

Tavolo monolitico in vetro  
curvato da 15 mm  
trasparente  
o in vetro extralight.

Monolithic dining table  
in transparent or extralight  
15 mm-thick curved glass.

Table d'une seule dalle  
de verre cintré de 15 mm  
transparent ou extralight.

Tisch aus 15 mm-starkem  
transparentem  
oder extralight gebogenem  
Glas, aus einer einzigen  
Glasplatte gefertigt.

Tavolo monolitico in vetro.  
Monolithic glass table.

228 x 108 x 75 cm  
89 3/4" x 42" x 29 1/2"





Tavolo rettangolare.  
Rectangular table.  
220 x 100 x 74 cm  
87" x 39 3/8" x 29 1/8"

# atlas

DESIGN DANNY LANE

Tavolo con piano  
in vetro temperato  
da 19 mm. Gambe  
composte da sezioni  
di vetro scolpito a mano  
di spessore 20 mm  
ed incollate l'una sull'altra.  
Disponibile anche  
con piano su misura.

Table with tempered  
glass top 19 mm thick.  
Legs consisting  
in sections of  
hand-sculpted glass  
20 mm thick, glued one  
on top of the other.  
Also available with  
custom-sized top.

Table avec plateau  
en verre trempé  
de 19 mm. Pieds  
composés de sections  
en verre sculpté à la main  
d'une épaisseur de 20 mm  
et collées l'une sur l'autre.  
Egalement disponible  
avec plateau sur mesure.

Tisch mit 19 mm  
starker Platte  
aus gehärtetem Glas.  
Beine aus aufeinander  
geklebten, 20 mm  
starken, handbehauenen  
Glaselementen.  
Auch mit maßgefertigter  
Platte erhältlich.

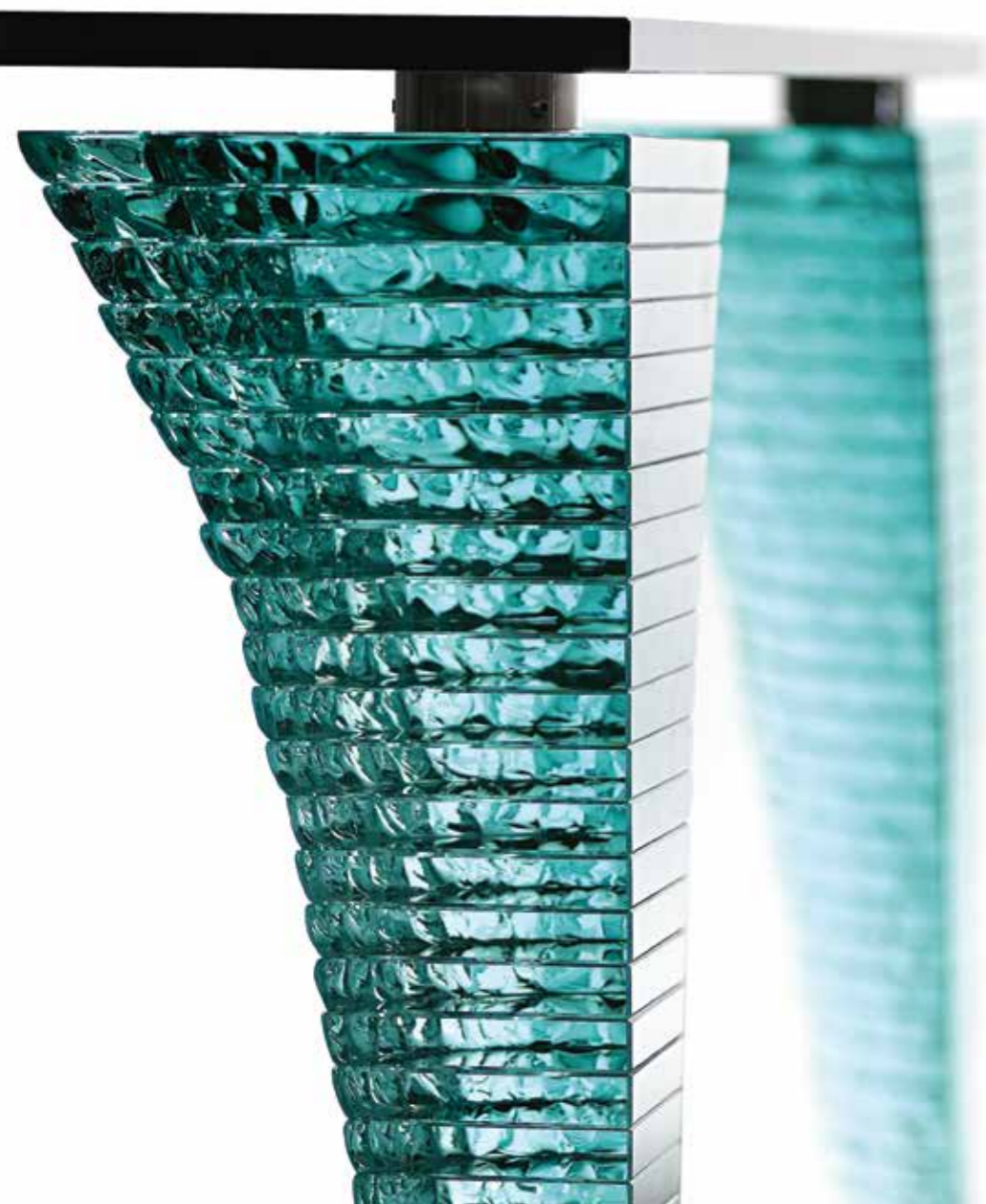

Tavolo rettangolare.  
Rectangular table.

220 x 100 x 74 cm  
87" x 39 3/8" x 29 1/8"





Tavolo rettangolare in vetro bronzo.  
Rectangular table in bronze glass.

240 x 120 x 75 cm  
94 1/2" x 47 1/4" x 29 1/2"

# luxor

DESIGN RODOLFO DORDONI

Tavolo con piano in vetro fumé o bronzo stratificato da 8+8 mm finitura filo lucido tondo, disponibile anche in vetro trasparente o extralight da 12 e da 15 mm. A seconda della misura e della configurazione desiderata base composta da 2, 3 o 4 cilindri (Ø 40 cm) in vetro da 10 mm, fumé, bronzo, NERO 95, trasparente o extralight, extralight retroverniciato bianco o retroargentato verniciato bianco. È possibile realizzare il piano su misura.

Table with a 8 mm + 8 mm laminated smoked or bronze glass top, shiny polished edge, also available in transparent glass or extralight glass (12 or 15 mm thick). 10 mm-thick curved glass bases, composed of 2, 3 or 4 cylinders (Ø 40 cm) depending on the size and the shape requested. The glass bases available in the following finishings: transparent, extralight, extralight white back-stained or extralight back-silvered white stained, Black 95 (NERO 95), smoked or bronze. It is possible to order custom-sized tops.

Table avec plateau en verre feuilleté de 8+8 mm fumé ou bronze, finition bord poli arrondi, disponible aussi en verre transparent ou extralight de 12 ou 15 mm. Selon la mesure ou la configuration choisie, base composée par 2, 3 ou 4 cylindres (Ø 40 cm) en verre de 10 mm. fumé, bronze, Noir 95 (NERO 95), transparent ou extralight, extralight verni dessous blanc, extralight argenté verni dessous blanc. Plateau disponible aussi en version sur mesure.

Tisch mit 8+8 mm-starker Schichtglasplatte in Rauch- oder Bronze-Glas oder in transparentem bzw. extralight Glas, 12 oder 15 mm Stärke. Untergestell bestehend aus 2, 3 bzw. 4 Glas-Zylindern (Durchmesser 40 cm) abhängig von den gewünschten Massen und Gestaltung, 10 mm. Glasstärke. Lieferbar in den folgenden Ausführungen: Rauch- oder Bronzeglas, Schwarz 95 (NERO 95)-Glas, transparentes bzw. extralight-Glas, weiss lackiertes extralight-Glas oder extraligh-Glas versilbert mit Weiß Lackierung. Die Tischplatte kann nach Maß bestellt werden.

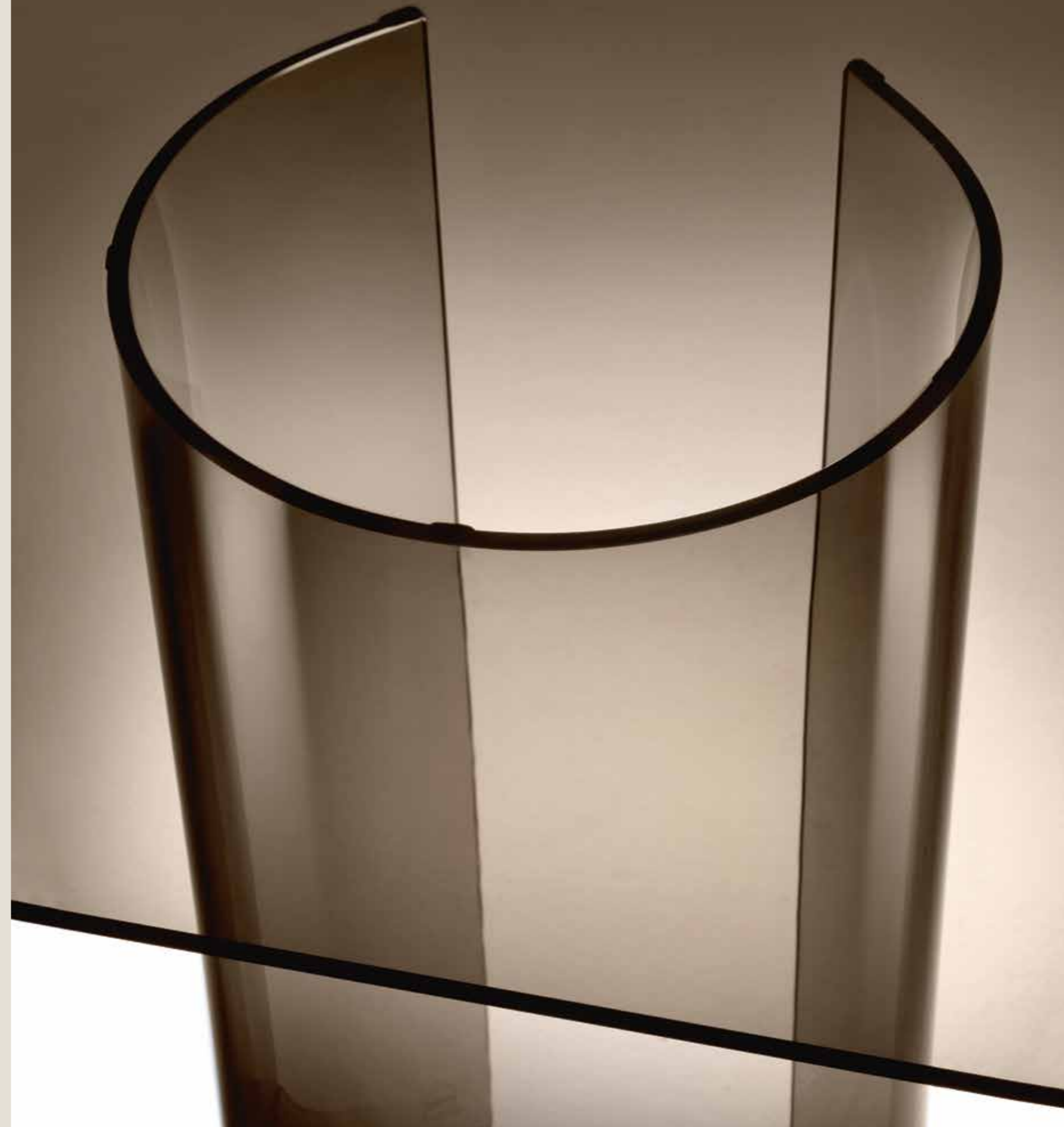



Tavolo ellittico.  
Elliptic table.  
210 x 135 x 75 cm  
82 1/16" x 54" x 29 1/2"

# sahara

BARTOLI DESIGN

Tavolo composto da basi in vetro trasparente o vetro extralight curvato da 10 mm e piano in vetro trasparente o vetro extralight da 15 mm. Il tavolo Sahara è disponibile anche con piani a misura.

Table consisting of 10 mm curved transparent or extralight glass bases and 15 mm transparent or extralight glass top. The Sahara table is also available with tops of customized size.

Table composée de bases en verre transparent ou en verre extralight cintré de 10 mm et d'un plateau en verre transparent ou en verre extralight de 15 mm. La table Sahara est également disponible avec plateau sur mesure.

Tisch mit Untergestell aus gebogenem transparentem Glas oder Extralight-Glas Stärke 10 mm, und 15 mm starker Platte aus transparentem oder Extralight-Glas. Auch mit maßgefertigter Platte lieferbar.



# corner

DESIGN CRS FIAM

Tavolo composto da basi in vetro curvato da 12 mm con lati da 45 cm e piano in vetro da 15 mm rettangolare, quadrato o rotondo.

Table with 12 mm-thick curved glass base (sides 45 cm) and 15 mm-thick glass top rectangular, square or round.

Table avec piètement en verre cintré de 12 mm, côtés de 45 cm. Top en verre de 15 mm rectangulaire, carré, rond.

Tisch mit 15 mm-starker Glasplatte. Untergestell aus 12 mm-starkem gebogenem Glas mit Winkeln von 45 cm. Glastisch mit rechteckiger, viereckiger oder runder Glasplatte.

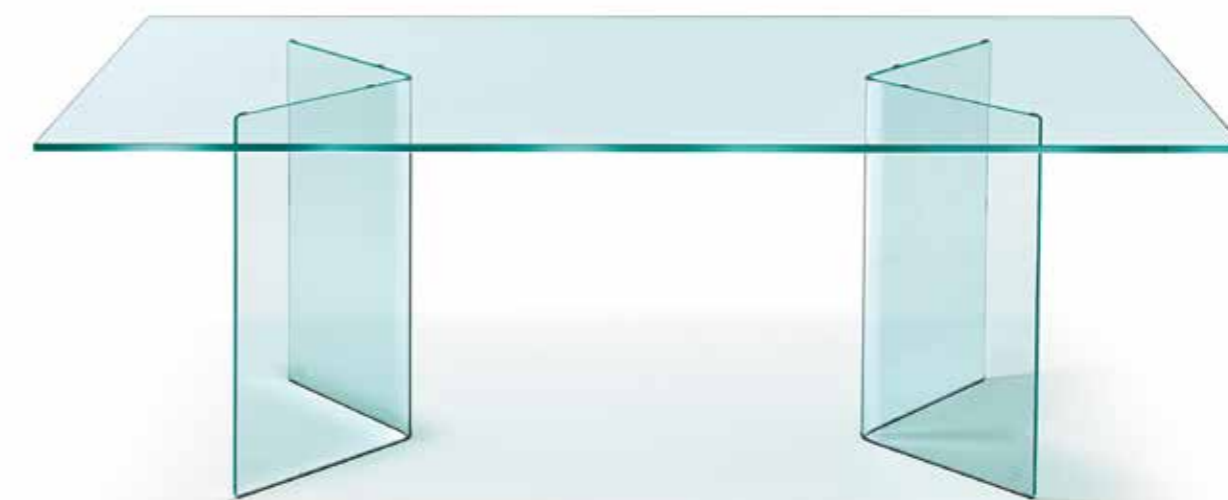

Tavolo rettangolare.  
Rectangular table.

180 x 90 x 73 cm  
70 7/8" x 35 7/16" x 28 3/4"



# ray

BARTOLI DESIGN

Tavolo composto da piano in vetro da 15 mm e gambe smontabili in vetro curvato da 20 mm. Giunzioni in alluminio finitura brill. Nella versione rettangolare il piano è realizzabile al centimetro fino ad una lunghezza di cm 280. Disponibile anche in vetro extralight.

Dining table with 15 mm-thick glass top and detachable legs in 20 mm-thick curved glass. Joints in aluminium with gloss finishing. The rectangular shaped top version can be custom ordered up to a maximum length of 280 cm. Also available in extralight glass.

Table avec plateau en verre de 15 mm et pieds démontables en verre cintré de 20 mm. Jonctions en aluminium finition brillante. Dans la version rectangulaire le plateau peut être réalisé au centimètre jusqu'à une longueur de cm 280. Disponible aussi en verre extralight.

Tisch mit 15 mm-starker Glasplatte und abnehmbaren Tischbeinen aus 20 mm-starkem gebogenem Glas. Die Verbindungen sind in Aluminium mit Finish hochglanz. Zentimetergenaue Maßanfertigung (Länge max. 280 cm) für die rechteckige Version. Lieferbar auch aus extralight-Glas.

Tavolo rettangolare.  
Rectangular table.

280 x 100 x 75 cm  
110 1/4" x 39 3/8" x 29 1/2"





Tavolo allungabile in vetro extralight.  
Extensible table in extralight glass.

200 (304) x 100 x 75 cm  
78 3/4" (119 11/16") x 39 3/8" x 29 1/2"

Vetrina Milo Sideboard.  
Milo Sideboard showcase.



## ray plus

BARTOLI DESIGN

Tavolo allungabile con piano in vetro temperato da 15 mm, rettangolare, prolunghie indipendenti in vetro temperato da 12 mm lunghe 52 o 41 cm. Gambe smontabili in vetro curvato da 20 mm montate a filo del piano. Braccio ruotante in alluminio finitura brill con piastre in acciaio inox. Disponibile anche in vetro extralight.

Extensile dining table with rectangular 15 mm-thick tempered glass top and independent 52 or 41 cm-long extensions in 12 mm-thick tempered glass. Detachable legs in 20 mm-thick curved glass, placed just under the top edge. Rotating mechanism in aluminium, gloss finishing and stainless steel plates. Also available in extralight glass.

Table à rallonges avec plateau en verre trempé de 15 mm rectangulaire et rallonges indépendantes en verre trempé de 12 mm, longueur 52 ou 41 cm par côté. Pieds démontables en verre cintré de 20 mm positionnés au bord du plateau. Bras en aluminium finition brillante et plaques en acier inox. Disponible aussi en verre extralight.

Ausziehbarer Tisch mit rechteckiger 15 mm-starker gehärteter Glasplatte und unabhängigen Verlängerungen aus 12 mm-starkem gehärtetem Glas, Länge 52 oder 41 cm pro Seite. Abnehmbare Tischbeine aus 20 mm - starkem gebogenem Glas, bündig an der Plattenkante montiert. Drehbarer Mechanismus aus Aluminium, Finish hochglanz und Platten aus rostfreiem Stahl. Der Tisch ist auch aus extralight-Glas lieferbar.

# ray plus

BARTOLI DESIGN



Tavolo allungabile in vetro extralight.  
Extensible table in extralight glass.

200 (304) x 100 x 75 cm  
78 3/4" (119 1/16") x 39 3/8" x 29 1/2"



Tavolo allungabile  
in vetro extralight.  
Extensible table  
in extralight glass.

200 (304) x 100 x 76 cm  
78 3/4" (119 1/16") x 39 3/8" x 30"

Sedie Bacall.  
Bacall chairs.



## kayo

DESIGN SATYENDRA PAKHALÈ

Tavolo allungabile con piano in vetro temperato da 15 mm, prolunghe indipendenti in vetro temperato da 12 mm profonde 52 cm. Gambe smontabili in vetro curvo da 19 mm e meccanismo in metallo finitura alluminio brill satinato o champagne satinato, con piastre in acciaio inox.

Extensible table with 15 mm top in tempered glass, independent extensions in 12 mm tempered glass, 52 cm long each. Detachable legs in 19 mm curved glass and mechanism in brushed metal, polished aluminium finish or champagne finish. Stainless steel plates.

Table à rallonges avec plateau en verre trempé de 15 mm, rallonges indépendantes en verre trempé de 12 mm, longueur 52 cm par côté. Pieds démontables en verre cintré de 19 mm et mécanisme en métal satiné finition aluminium brillant ou champagne avec plaques en acier inox.

Ausziehbarer Tisch mit Platte aus 15 mm starkem gehärtetem Glas, unabhängige Verlängerungen aus 12 mm starkem gehärtetem Glas, Länge 52 cm. Abnehmbare Beine aus gebogenem 19 mm starkem Glas und Mechanismus aus satiniertem Metall mit Aluminium Finish, hochglanzpoliert oder Champagne-Finish. Platten aus Edelstahl.

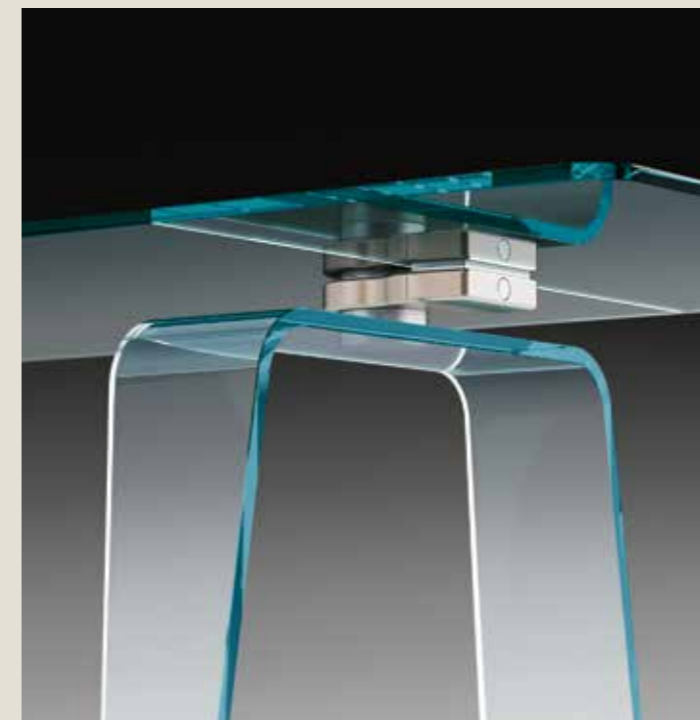



Tavolo allungabile  
in vetro extralight.  
Extensible table  
in extralight glass.  
200 (304) x 100 x 76 cm  
78 3/4" (119 1/16") x 39 3/8" x 30"  
Sedie Bacall.  
Bacall chairs.



Tavolo allungabile.  
Extendible table.  
200 (304) x 100 x 76 cm  
78 3/4" (119 11/16") x 39 3/8" x 30"  
Sedie Callas.  
Callas chairs.



atlas	216
cannage	176
charlotte	254
grillo	262
hype	204
lakes	194
macramè	240
macramè large	238
magique	264
magma	202
neutra	224
pixel	210
ponte	256
quadra	228
rialto	244
rialto piano	248
rialto side	249
rialto tris	250
roy	234
shell	220
sigmy	258
toki	260
waves	182

TAVOLI BASSI  
E DI SERVIZIO

COFFEE TABLES  
AND SIDE TABLES

TABLES BASSES  
ET D'APPOINT

COUCHTISCHE  
UND BEISTELLTISCHE



Tavolini con piano in vetro fuso,  
finitura ambra, fumo e trasparente.  
Coffee table with fused glass top,  
amber, smoke grey and transparent finishes.

Ø 50 x 55 cm    Ø 65 x 45 cm    Ø 90 x 40 cm  
 Ø 19 11/16 x 21 5/8"    Ø 25 9/16 x 17 11/16"    Ø 35 7/16 x 15 3/4"



## cannage

DESIGN EMMANUEL GALLINA

Tavolino con piano in vetro da 10 mm temperato e fuso a gran fuoco con trama "Cannage", disponibile nella finitura incolore oppure retroverniciato con tinte semi-trasparenti Fumo o Ambra. Struttura in legno massello, finitura rovere tabacco a poro aperto.

Coffee table with 10 mm tempered and fused glass top with "Cannage" texture, available in natural, Smoke Grey or Amber back-painted semi-transparent finishes. Solid wood structure in tobacco oak, open-pore finish.

Table basse avec plateau en verre en fusion et trempé de 10 mm avec trame « Cannage », disponible transparent ou vernie dessous avec des teintes semi-transparentes Fumé ou Ambre. Structure en bois massif, finition chêne de tabac à pore ouvert.

Coucchtisch aus geschmolzenem und gehärtetem 10 mm Glas mit "Cannage" Dekor in den folgenden Ausführungen erhältlich: transparent oder semi-transparent rauch oder bernstein unterlackiert. Untergestell aus massivem Holz in der Ausführung Eiche-Tabak offenporig.

Tavolini con piano in vetro fuso, finitura ambra, fumo e trasparente.  
Coffee table with fused glass top, amber, smoke grey and transparent finishes.

Ø 65 x 45 cm    Ø 90 x 40 cm    Ø 120 x 40 cm  
Ø 25 9/16 x 17 11/16"    Ø 35 7/16 x 15 3/4"    Ø 47 1/4 x 15 3/4"



## cannage

DESIGN EMMANUEL GALLINA

Tavolini con piano  
in vetro fuso, finitura ambra,  
fumo e trasparente.  
Coffee table with fused glass  
top, amber, smoke grey  
and transparent finishes.

Ø 50 x 55 cm  
Ø 19 11/16 x 21 5/8"

Ø 65 x 45 cm  
Ø 25 9/16 x 17 11/16"

Ø 90 x 40 cm  
Ø 35 7/16 x 15 3/4"



Piano in DV-Glass colorato  
Base finitura nichel nero lucido.

Colored DV-Glass top  
Black glossy nickel finish base.

90 x 90 x 30 cm  
35 7/16" x 35 7/16" x 11 13/16"

120 x 120 x 35 cm  
47 1/4" x 47 1/4" x 13 3/4"

90 x 40 x 45 cm  
35 7/16" x 15 3/4" x 17 11/16"

# waves

DESIGN LUDOVICA + ROBERTO PALOMBA

Tavolino con piano in DV Glass da 23 mm trasparente o a strisce colorate. Base in metallo finitura Titanio opaco oppure Nichel Nero lucido.

Coffee table available in transparent or in line colored glass, with top made of 23 mm DV Glass. Metal base available in opaque Titanium or in Black Glossy Nickel.

Table avec plateau en verre en fusion de 15 mm trempé, disponible dans les teintes transparentes Fumées, Bleues ou Naturel effet satiné. Structure en bois massif de chêne disponible dans les finitions naturelle ou de couleur grise.

Tisch mit Platte aus 15 mm geschmolzenem und gehärtetem Glas in den folgenden Ausführungen erhältlich: Rauch, Blau, Bernstein oder transparent mit satiniertem Effekt. Untergestell aus massivem Eichenholz in den folgenden Ausführungen erhältlich: Natur - oder Grau-gefärbt.



**RIPIANO INFERIORE  
OPZIONALE  
OPTIONAL  
LOWER SHELF**

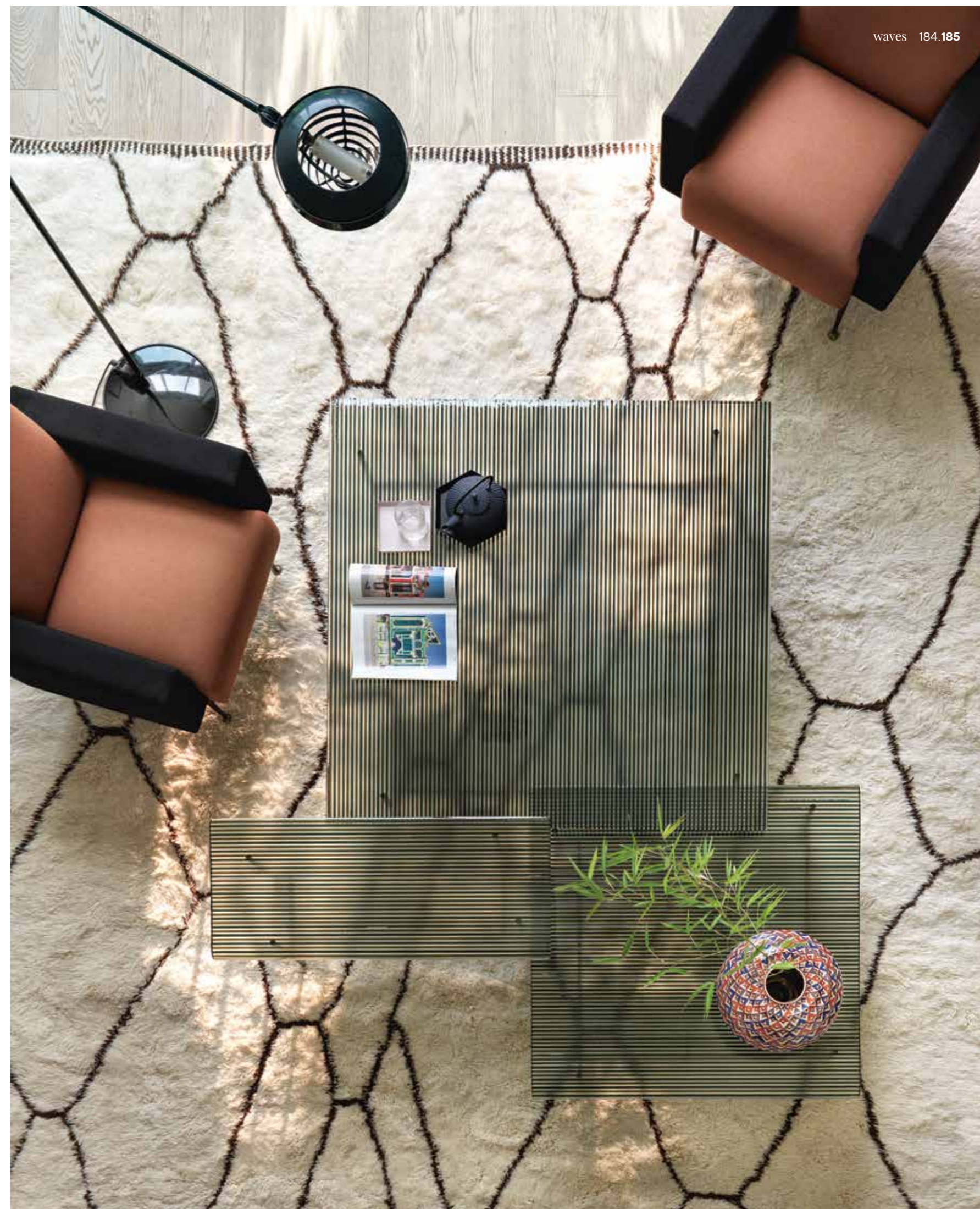

## waves

DESIGN LUDOVICA + ROBERTO PALOMBA

Piano in DV-Glass colorato  
Base finitura nichel nero lucido.

Colored DV-Glass top  
Black glossy nickel finish base.

90 x 40 x 35 cm  
35 7/16" x 15 3/4" x 13 3/4"

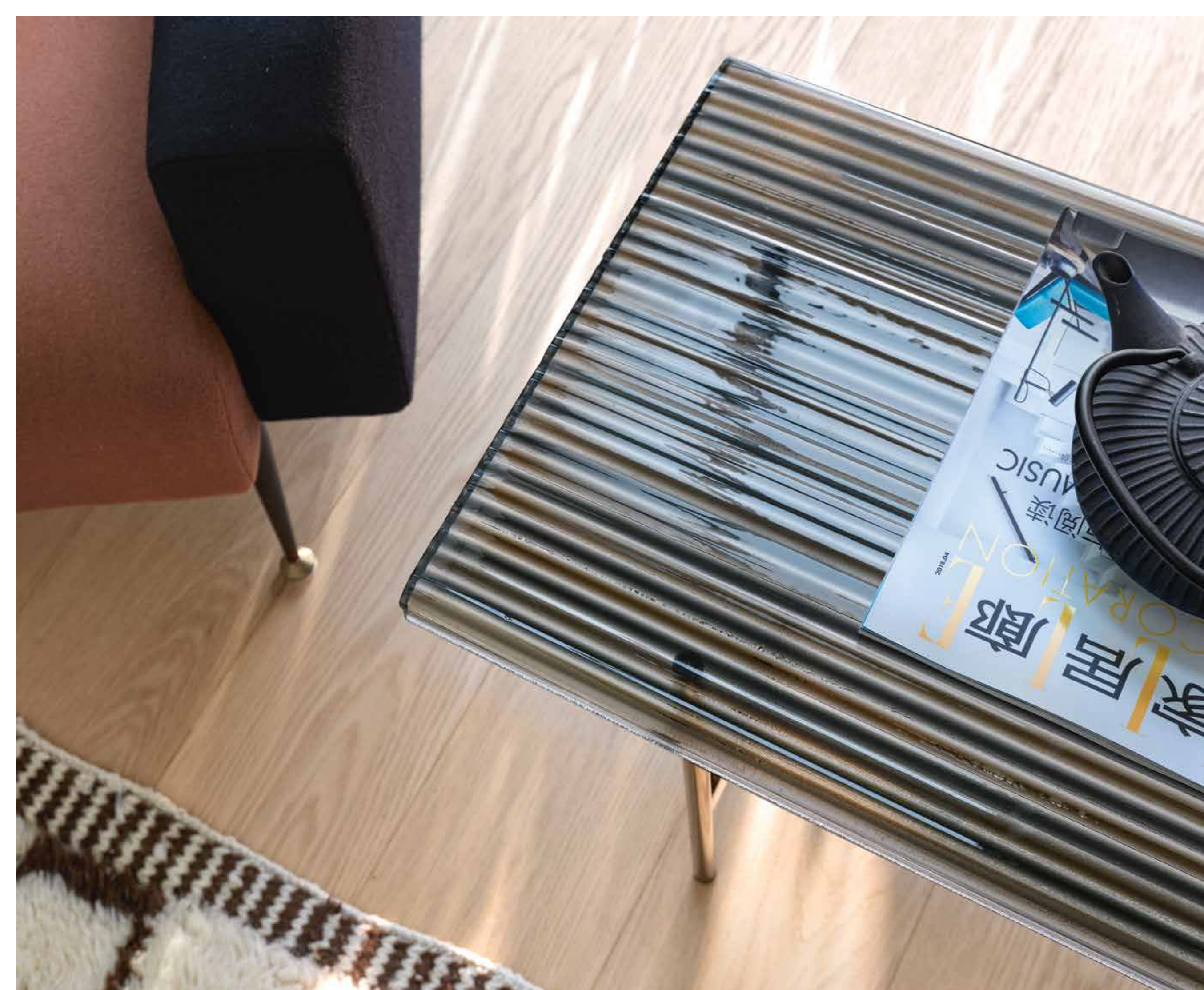



## waves

DESIGN LUDOVICA + ROBERTO PALOMBA



Piano in DV-Glass colorato  
Base finitura nichel nero lucido.  
Colored DV-Glass top  
Black glossy nickel finish base.

38 x 38 x 50 cm  
15" x 15" x 19 1/16"



# waves

DESIGN LUDOVICA + ROBERTO PALOMBA



Piano in DV-Glass trasparente  
Base finitura titanio opaco.  
Transparent DV-Glass top  
Opaque titanium finish base.

90 x 90 x 30 cm  
35 7/16" x 35 7/16" x 11 13/16"  
120 x 40 x 40 cm  
47 1/4" x 15 3/4" x 15 3/4"





Piano in DV-Glass trasparente  
Base finitura titanio opaco.  
Transparent DV-Glass top  
Opaque titanium finish base.  
90 x 90 x 30 cm  
35 7/16" x 35 7/16" x 11 13/16"





# lakes

DESIGN STUDIO KLASS

Tavolino con piano in vetro da 10 mm fuso a gran fuoco, temperato e retroverniciato con tinte metallizzate Grigio Lava, Marrone Ramato, Blu Notte o Champagne. Base in metallo verniciato, finitura Grigio Lava o Champagne metallizzato.

Coffee table with 10 mm fused, tempered and back-lacquered glass top with metal shades Lava Grey, Copper Brown, Night Blue or Champagne. Metal painted base available in Lava Grey or metallic Champagne finishes.

Table basse avec plateau en verre en fusion de 10 mm, verni dessous avec des teintes métallisées Gris Lave, Cuivre Marron, Bleu Nuit ou Champagne. Base en métal verni, finition Gris Lave ou Champagne métallisé.

Couchtisch aus geschmolzenem Glas 10 mm, in den folgenden Metallfarben unterlackiert: Lavagrau, Kupfer braun, Nachtblau oder Champagne. Untergestell aus lackiertem Metall, in den Farbvarianten Lavagrau oder Champagnerfarbig.

Ø 50 x 50 cm  
Ø 19 11/16 x 19 11/16"

Ø 70 x 45 cm  
Ø 27 9/16 x 17 11/16"

Ø 100 x 40 cm  
Ø 39 3/8 x 15 3/4"



# lakes

DESIGN STUDIO KLASS

Piano in vetro fuso  
retroverniciato marrone ramato.  
Base in metallo finitura grigio lava.  
Fused glass top,  
copper brown back-painted  
Metal base, lava grey finish.

Ø 50 x 50 cm  
Ø 19 1/16 x 19 1/16"



# magma

DESIGN PATRICK JOUIN



Tavolino con piano in vetro da 12 mm fuso a gran fuoco e temperato, disponibile nelle tinte trasparenti Fumo, Blu, Ambra o Naturale effetto satinato. Struttura in legno massello disponibile nelle finiture rovere naturale o tinto grigio.

Coffee table with 12 mm fused and tempered glass top, available in Smoke grey, Blue, Amber or Natural satin finish. Solid wood structure available in natural or grey oak finish.

Table basse avec plateau en verre en fusion de 12 mm trempé, disponible dans les teintes transparentes Fumées, Bleues, Ambres ou Naturel effet satiné. Structure en bois massif de chêne disponible dans les finitions naturelle ou de couleur grise.

Couchtisch mit Platte aus 12 mm geschmolzenem und gehärtetem Glas in den folgenden Ausführungen erhältlich: Rauch, Blau, Bernstein oder transparent mit satiniertem Effekt. Untergestell aus massivem Eichenholz in den folgenden Ausführungen erhältlich: Natur- oder Grau-gefärbt.

Piano in finitura ambra, Base finitura rovere tinto grigio.

Amber finish glass top, Grey oak finish base.

120 x 120 x 40 cm  
47 1/4" x 47 1/4" x 15 3/4"

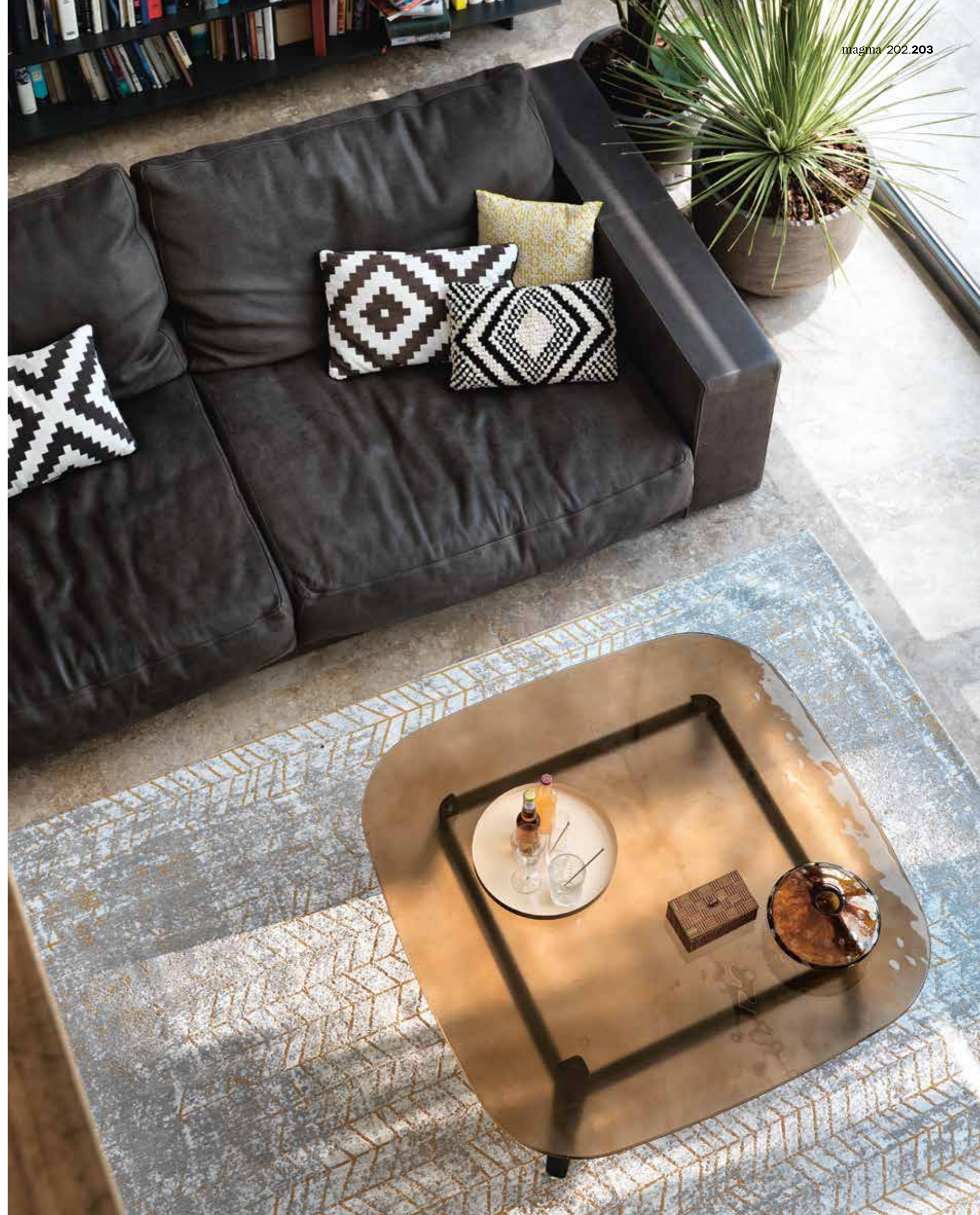



# hype

DESIGN STUDIO KLASS

Tavolino con piano in vetro da 12 mm fuso a gran fuoco, temperato e retroverniciato con tinte metallizzate Grigio Lava, Marrone Ramato o Champagne.  
Base in metallo verniciato, finitura Grigio Lava.

Coffee table with 12 mm fused, tempered and back-lacquered glass top with metal shades Lava Grey, Copper Brown or Champagne.  
Metal painted base, "Lava Grey" finish.

Table basse avec plateau en verre en fusion de 12 mm, trempé et verni dessous avec des teintes métallisées Gris Lave, Cuivre Marron ou Champagne.  
Base en métal verni, finition Gris Lave.

Couchtisch aus geschmolzenen und gehärtetem Glas 12 mm in den folgenden Metallfarben unterlackiert: Lavagrau, Kupfer braun oder champagnerfarbig.  
Untergestell aus Metall in der Farbvariante Lavagrau.

Piano in vetro fuso retroverniciato marrone ramato.  
Fused glass top, copper brown back-painted.

90 x 45 x 42 cm  
35 <sup>7</sup>/<sub>16</sub> x 17 <sup>11</sup>/<sub>16</sub> x 16 <sup>9</sup>/<sub>16</sub>"



hype

DESIGN STUDIO KLASS

Piano in vetro fuso  
retroverniciato champagne.  
Fused glass top,  
champagne back-painted.

140 x 70 x 42 cm  
55 1/8 x 27 9/16" x 16 9/16"







# pixel

DESIGN VITTORIO LIVI

Tavolino con piano  
in vetro Multicolor  
e base in metallo  
finitura Titanio opaco.

Coffee table with  
Multicolor glass top  
and opaque titanium  
finish metal base.

Table basse avec plateau  
en verre Multicolore  
et base en métal  
finition Titane opaque.

Couhtisch mit Platte  
aus buntem Glas.  
Untergestell aus  
Metall in der matt  
Titan-Ausführung.



44 x 44 x 50 cm  
17 5/16" x 17 5/16" x 19 11/16"  
92 x 49 x 40 cm  
36 1/4" x 19 5/16" x 15 3/4"  
122 x 67 x 35 cm  
48" x 26 3/8" x 13 3/4"

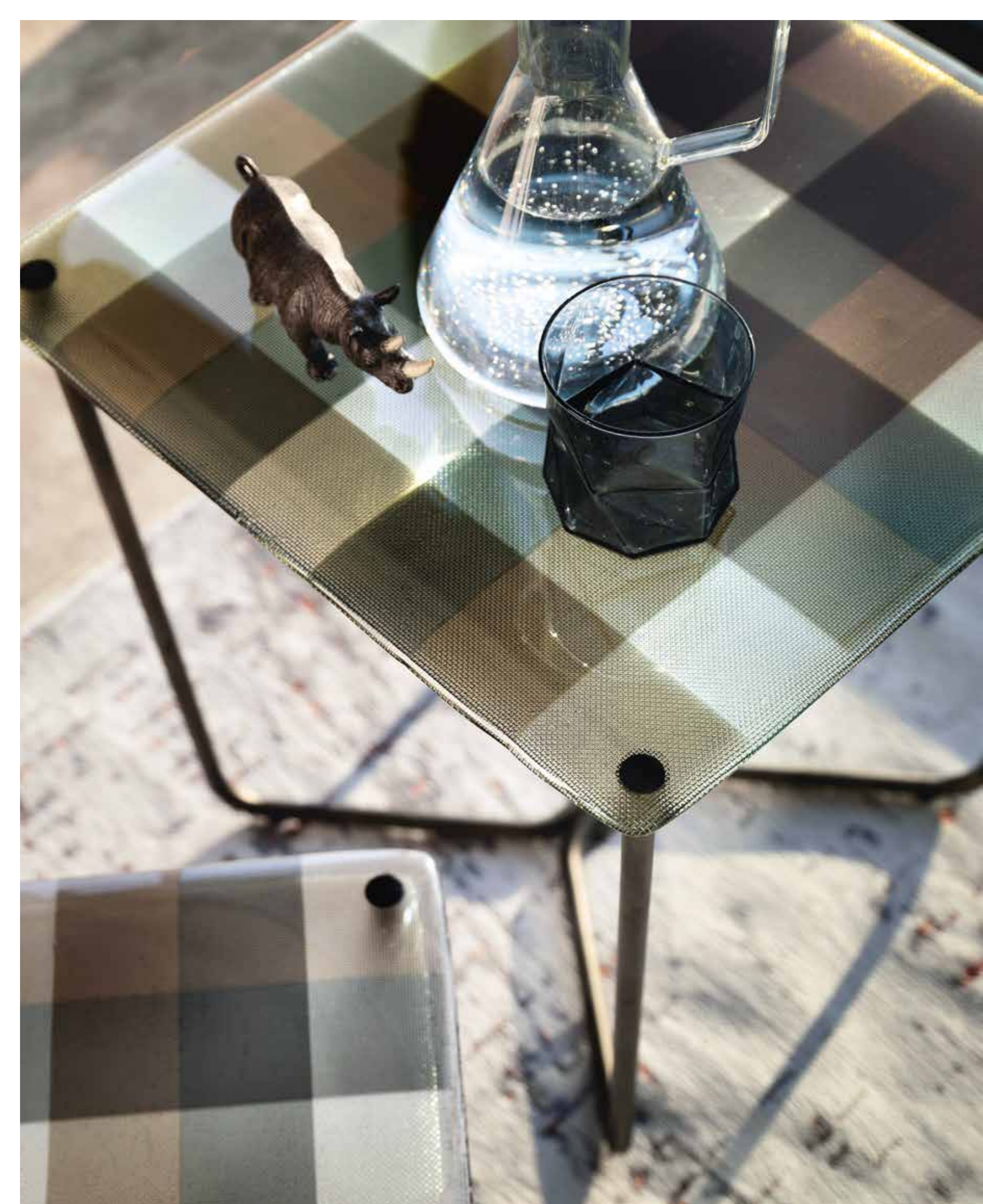

pixel

DESIGN VITTORIO LIVI



44 x 44 x 50 cm  
17 5/16" x 17 5/16" x 19 11/16"  
62 x 62 x 30 cm  
24 7/16" x 24 7/16" x 11 13/16"  
80 x 37 x 40 cm  
31 1/2" x 14 9/16" x 15 3/4"





Tavolino.  
Coffee table.  
148 x 70 x 40 cm  
58 1/4" x 27 9/16" x 15 3/4"

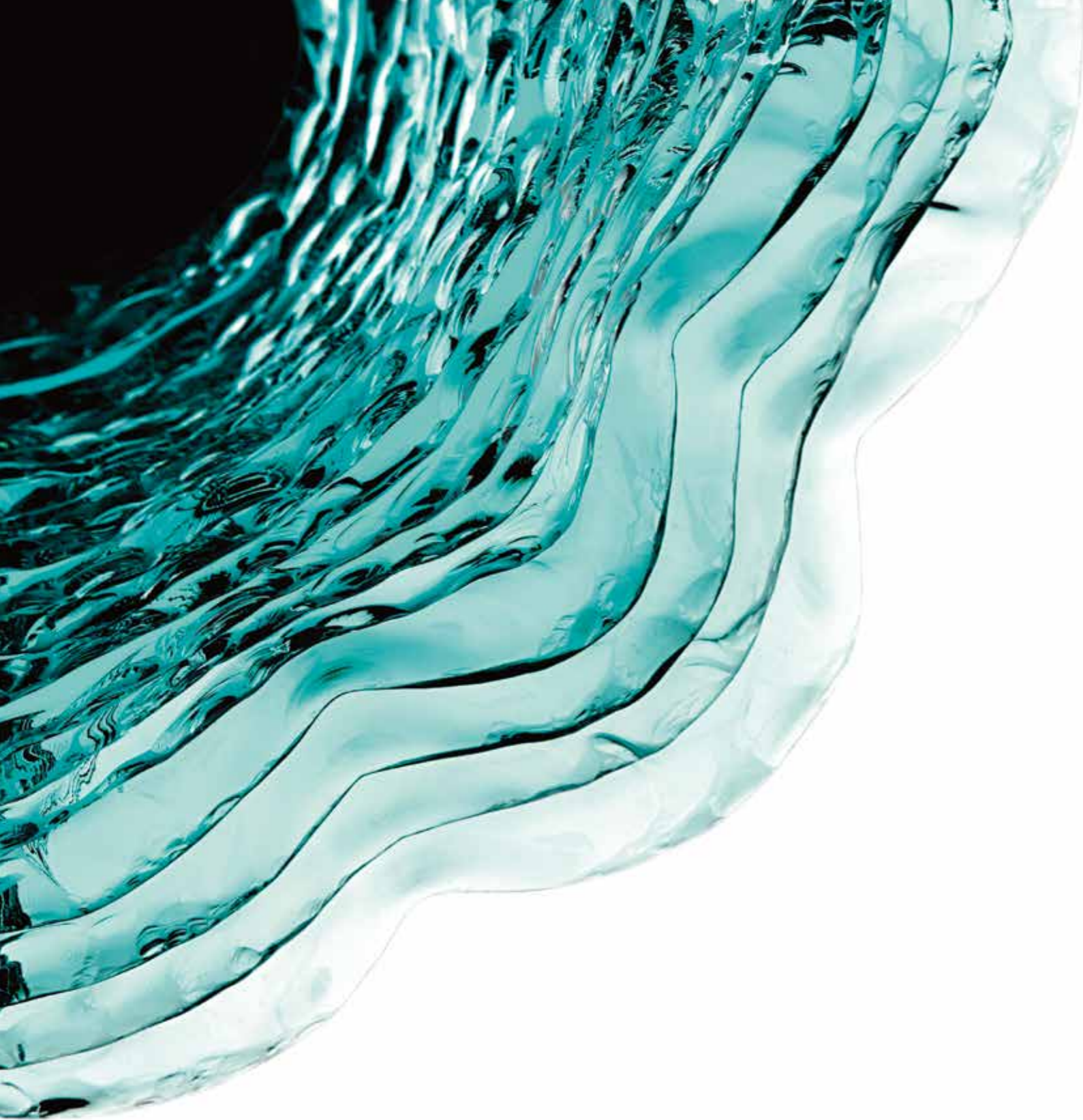

# atlas

DESIGN DANNY LANE

Tavolino in vetro  
curvato da 20 mm.  
Gambe composte  
da 19 sezioni di vetro  
sculpto a mano da 20 mm  
ed incollate l'una sull'altra.

Coffee table  
in 20 mm-thick curved  
glass with hand sculptured  
legs, composed  
of 19 single 20 mm-thick  
glass elements  
glued together.

Table basse en verre  
cintré de 20 mm.  
Pieds composés  
de 19 sections en verre  
de 20 mm sculptées  
à la main et encollées.

Couchtisch aus 20 mm-  
starkem gebogenem Glas.  
Handbehauene Tischbeine  
aus 20 mm-starkem Glas.



Tavolino.  
Coffee table.  
148 x 70 x 40 cm  
58 1/4" x 27 9/16" x 15 3/4"

# shell

DESIGN DANNY LANE

Tavolino con piano  
in vetro scolpito  
a mano da 15 mm.  
Base a cinque elementi  
in vetro scolpito  
a mano da 12 mm,  
di cui quattro curvati.  
Parti metalliche  
in acciaio inox.

Coffee table  
with hand-sculptured  
15 mm-thick glass top.  
Base made of five  
12 mm-thick  
hand-sculptured  
glass elements,  
four of which curved.  
Hardware  
in stainless steel.

Table basse avec  
plateau en verre  
de 15 mm sculpté  
à la main. Le piétement  
se compose de cinq  
éléments en verre  
de 12 mm aussi sculptés  
à la main, quatre  
sont cintrés. Détails  
métalliques en acier inox.

Couchtisch mit  
handbehauener 15-mm  
starker Glasplatte.  
Untergestell aus fünf  
handbehauenen  
Elementen aus 12 mm-  
starkem Glas, vier sind  
gebogen. Metallteile  
aus rostfreiem Stahl.

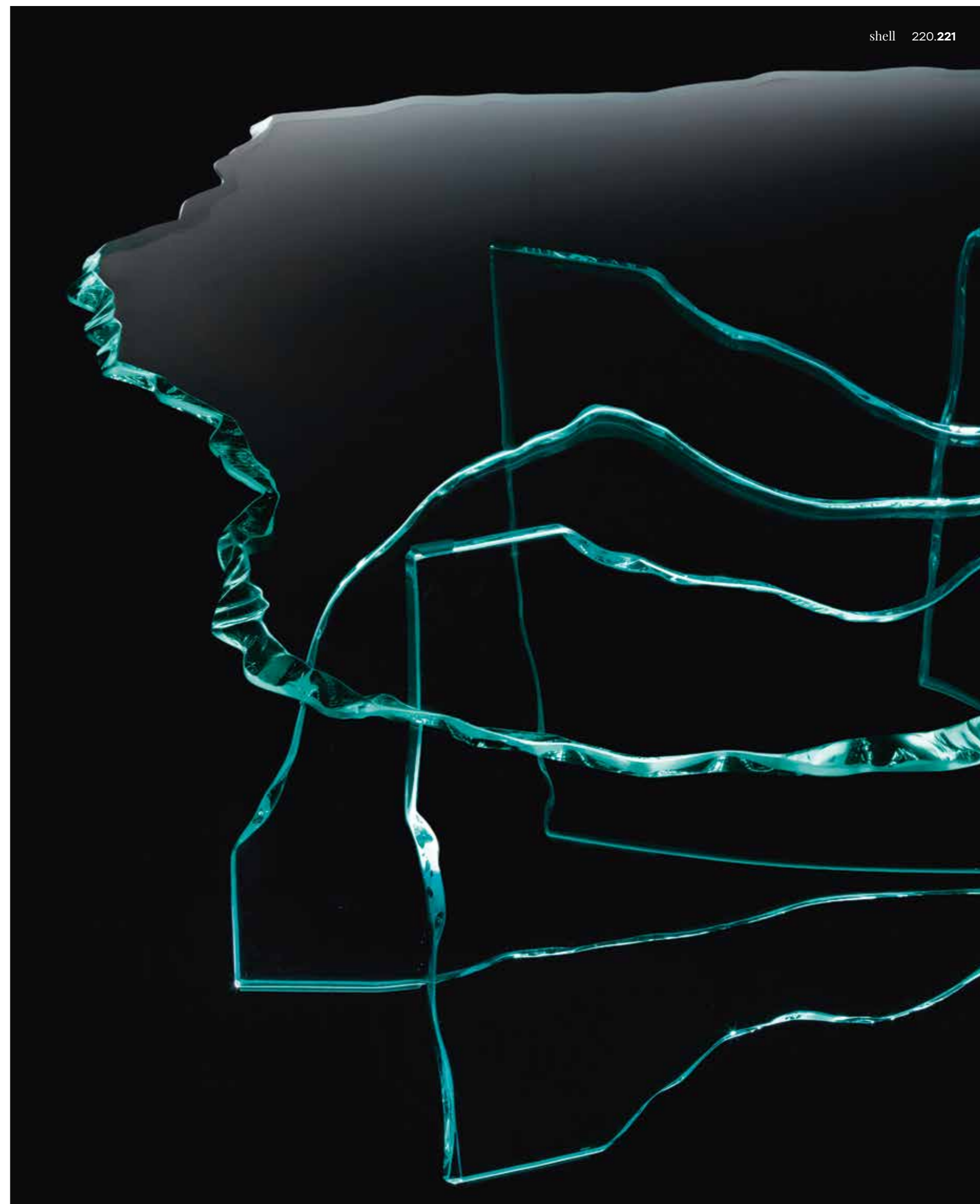
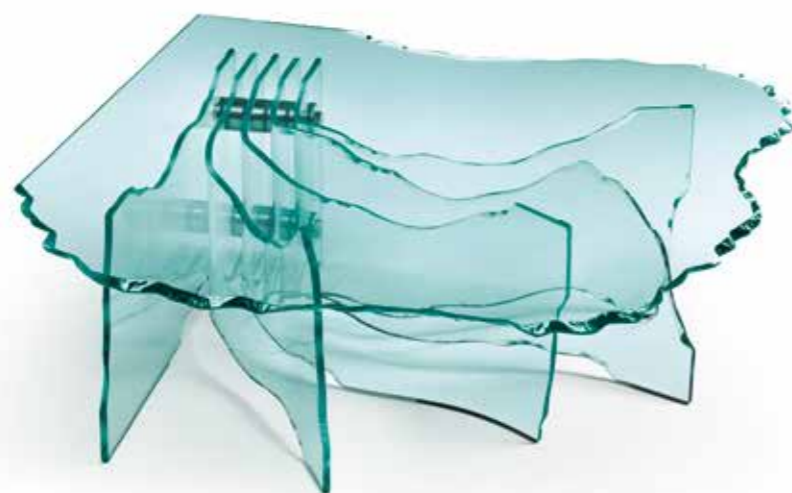



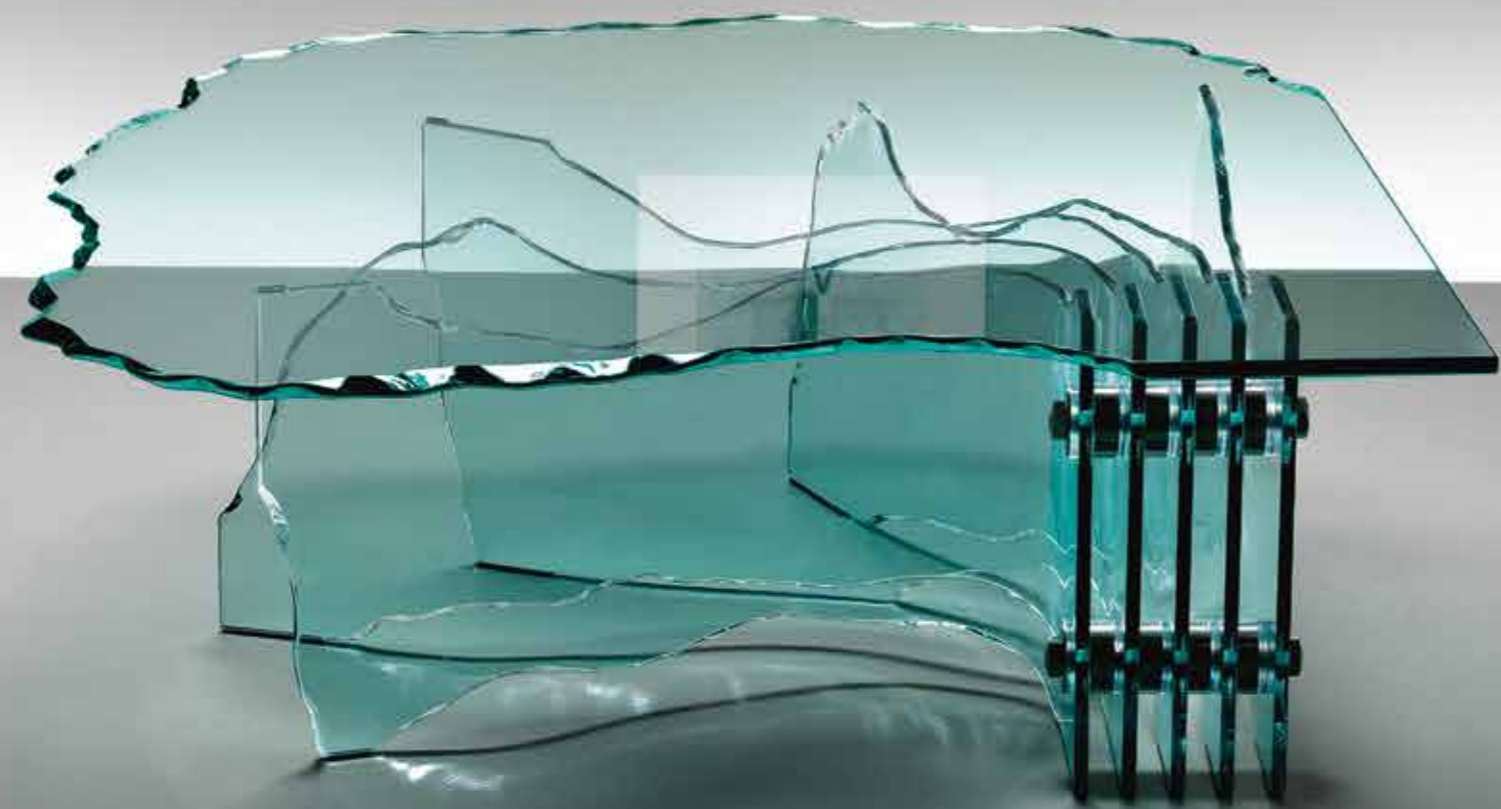

## shell

DESIGN DANNY LANE

Tavolino.  
Coffee table.  
125 x 125 x 40 cm  
49 3/16" x 49 3/16" x 15 3/4"



Tavolino in vetro extralight.  
Coffee table in extralight glass.

126 x 126 x 30 cm  
49 5/8" x 49 5/8" x 11 3/4"

# neutra

DESIGN RODOLFO DORDONI

Tavolo basso monolitico  
in vetro curvato da 12 mm.  
A richiesta, disponibile anche  
in vetro extralight, vetro  
extralight retroverniciato bianco  
e in vetro retroverniciato nero.

Monolithic coffee table  
in 12 mm-thick curved glass.  
On demand also available  
in extralight glass, extralight  
white back-stained glass  
and in black back-stained glass.

Table basse d'une seule dalle  
de verre cintré de 12 mm.  
Sur demande disponible aussi  
en verre extralight, verre  
extralight verni dessous blanc  
ou verre verni dessous noir.

Couchtisch aus einer einzigen  
12 mm-starken gebogenen  
Glasplatte gefertigt. Auf Wunsch  
lieferbar auch aus extralight-Glas,  
extralight-Glas mit weisser  
Hintergrundlackierung, oder mit  
schwarzer Hintergrundlackierung.

Tavolino in vetro  
retroverniciato nero.  
Coffee table in black  
back-painted glass.  
126 x 126 x 30 cm  
49 5/8" x 49 5/8" x 11 3/4"



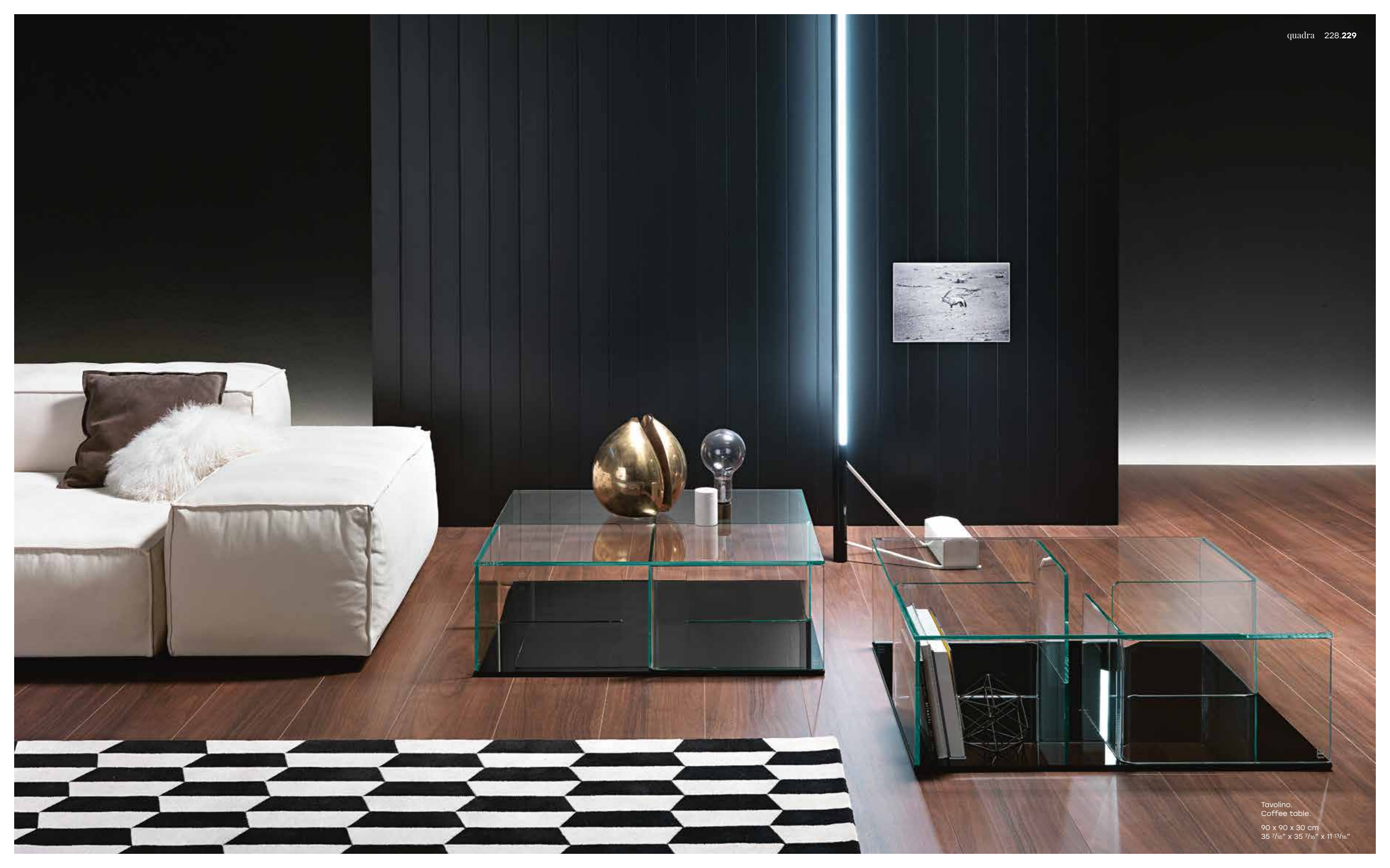

Tavolino.  
Coffee table.  
90 x 90 x 30 cm  
35 7/16" x 35 7/16" x 11 13/16"

# quadra

DESIGN MATTEO NUNZIATI

Tavolino contenitore  
composto da 4 elementi  
in vetro curvato da 10 mm  
interposti tra 2 piani  
in vetro da 10 mm.  
Piano superiore e divisori  
in vetro extralight;  
basi nelle seguenti  
varianti: vetro extralight  
trasparente, vetro  
extralight retroverniciato,  
vetro extralight  
retroargentato, vetro  
bronzo retroargentato.

Coffee table/storage  
unit composed of 4  
elements in 10 mm  
curved glass mounted  
between two 10 mm glass  
racks. Top and partitions  
in extralight glass, bases  
available in extralight  
glass, back-painted  
extralight glass,  
extralight mirrored  
glass, back-silvered  
bronze glass.

Table basse de rangement  
constituée de 4 éléments  
en verre cintré de 10 mm  
interposés entre 2  
plateaux en verre  
de 10 mm. Plateau  
supérieur et cloisons  
en verre extralight  
transparent ; bases dans  
les variantes suivantes :  
verre extralight  
transparent, verre  
extralight verni dessous  
blanc, verre extralight  
argenté, verre bronze  
argenté, verre noir 95.

Couchtisch mit  
Stauraum aus vier  
Elementen aus 10 mm  
starkem, gebogenem  
Glas zwischen zwei  
10 mm starken  
Glasplatten. Obere Platte  
und Trennelemente  
aus Extralight-Glas,  
Basis in den folgenden  
Ausführungen:  
Extralight-Glas,  
Extralight-Glas  
hinterlackiert weiß,  
Extralight-Glas.

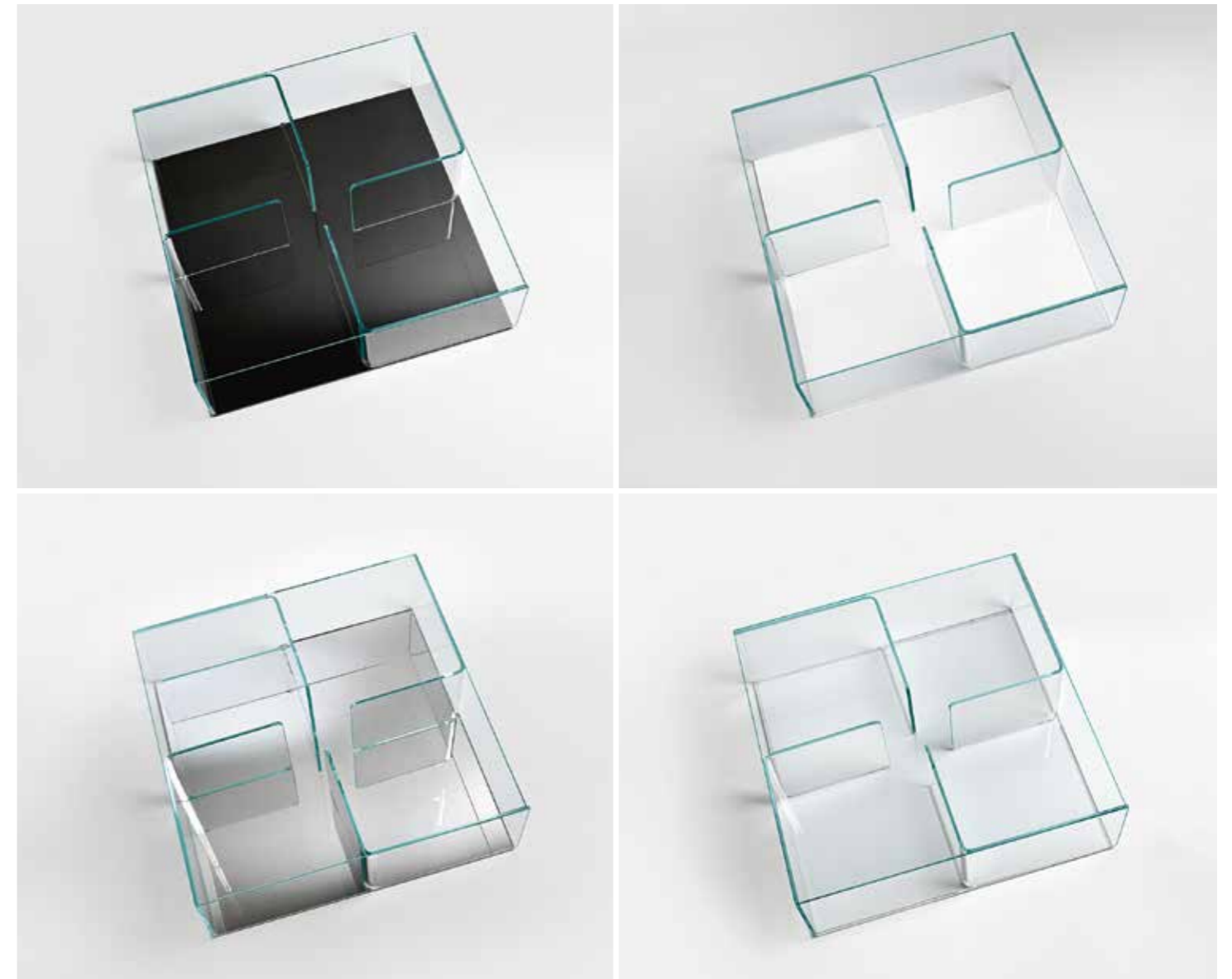

# quadra

DESIGN MATTEO NUNZIATI



Base in vetro bronzo  
retroargentato.  
Back-silvered bronze  
glass base.  
160 x 80 x 34 cm  
32" x 31 1/2" x 13 3/8"



# roy

DORIANA E MASSIMILIANO FUKSAS

Tavolino composto da un piano in vetro trasparente in appoggio su base di forma concava in vetro da 10 mm curvato retroargentato. 4 gambe smontabili verniciate nere, con piedini in acciaio spazzolato.

Coffee table consisting in a transparent top resting on a concave base in 10 mm curved glass, back-silvered, mounted on 4 removable black painted legs with brushed steel feet.

Table basse constituée d'un plateau en verre transparent sur base en verre cintré de 10 mm transparent ou fumé de forme concave, verni dessous argent. 4 pieds démontables en acier brossé peintes en noir.

Couchtisch mit transparenter Glasplatte auf einem Untergestell aus gebogenem Glas, Stärke 10mm., mit versilberter Rückseite und konkaver Form. Vier abnehmbare schwarz lackierte Beine mit Füßchen aus geburstedem Stahl.



# roy

DORIANA E MASSIMILIANO FUKSAS



Tavolino.  
Coffee table.

Ø 120 x 40 cm  
Ø 47 1/4" x 15 3/4"



# macramè large

DESIGN LUCIDI PEVERE

Tavolino composto da una base in vetro filato intrecciato in maniera artigianale e da un piano di vetro da 10 mm nelle seguenti finiture: piano extralight con base in vetro extralight, piano bronzo con base verniciata bronzo, piano in vetro fumè con base verniciata fumè.

Coffee table comprising hand-interwoven spun glass base and 10 mm glass top available the following finishes: extralight top with extralight glass base; bronze top with bronze painted base; fumè grey glass top with fumè grey painted base.

Table basse composée d'une base en verre filé tressé de manière artisanale et d'un plateau en verre de 10 mm proposée dans les finitions suivantes : plateau verre extralight avec base en verre extralight, plateau bronze avec base peinte coloris bronze, plateau en verre fumè avec base peinte coloris fumè.

Couchtisch mit Untergestell aus handwerklich gefertigtem Glasfädengeflecht und 10 mm starker Glasplatte. Lieferbar in den Finishes: Glasplatte und Untergestell aus extralight Glas, Bronzeglas Platte mit Untergestell Bronze lackiert, Rauchglas Platte mit Untergestell Rauch lackiert.

Tavolino in vetro bronzo.  
Coffee table in bronze glass.

130 x 86 x 33 cm  
51 3/16" x 33 7/8" x 12"



# macramè

DESIGN LUCIDI PEVERE

Tavolini in vetro  
fumè e bronzo.  
Coffee tables in smoked  
and bronze glass.

90 x 65 x 33 cm  
35 7/16" x 25 9/16" x 13"

50 x 50 x 50 cm  
19 11/16" x 19 11/16" x 19 11/16"



# macramè

DESIGN LUCIDI PEVERE

Collezione di tavolini composti da una base in vetro filato intrecciato in maniera artigianale e da un piano di vetro da 10 mm. La collezione di tavolini prevede le seguenti finiture: piano in vetro extralight con base in vetro extralight, piano in vetro bronzo con base verniciata bronzo, piano in vetro fumè con base verniciata fumè.

Collection of coffee tables comprising hand-interwoven spun glass base and 10 mm-thick glass top. The coffee table collection includes the following finishes: extralight glass top with extralight glass base; bronze glass top with bronze painted base; fumè grey glass top with fumè grey painted base.

Tables basses composées d'une base en verre filé tressé de manière artisanale et d'un plateau en verre de 10 mm. La collection de tables basses propose les finitions suivantes: plateau verre extralight avec base en verre extralight, plateau en verre bronze avec base peinte coloris bronze, plateau en verre fumè avec base peinte coloris fumè.

Tisch mit Unter Untergestell aus handwerklich gefertigtem Glasfädengeflecht und 10 mm starker Glasplatte. Lieferbar in den Finishes: Glasplatte und Untergestell aus extralight Glas, Bronzeglas Platte mit Untergestell Bronze lackiert, Rauchglas Platte mit Untergestell Rauch lackiert.

Tavolino in vetro extralight.  
Coffee table in extralight glass.

60 x 60 x 40 cm  
23 5/8" x 23 5/8" x 15 3/4"



# rialto

DESIGN CRS FIAM

Tavolo basso in vetro curvato da 10, 12 o 15 mm. Disponibile anche in vetro extralight. È possibile realizzare Rialto su misura.

Coffee table in 10, 12 or 15 mm-thick curved glass. Also available in extralight glass and customized sizes.

Table basse en verre de 10, 12 ou 15 mm. Disponible aussi en verre extralight et sur mesure.

Couchtisch aus 10, 12 oder 15 mm-starkem gebogenem Glas. Lieferbar auch aus extralight-Glas. Der Rialto kann nach Maß bestellt werden.

Tavolino, spessore vetro 15 mm.  
Coffee table, 15 mm glass thickness.

160 x 52 x 22 cm  
63" x 20 1/2" x 8 11/16"



rialto

DESIGN CRS FIAM



Tavolino,  
spessore vetro 15 mm.  
Coffe table,  
15 mm glass tickness.

120 x 120 x 32 cm  
47 1/4" x 47 1/4" x 12 5/8"

## rialto piano

DESIGN CRS FIAM

Tavolo basso in vetro curvato da 10 o 12 mm. Ripiano in vetro da 10 mm o 12 mm. Disponibile anche in vetro extralight. È possibile realizzare Rialto piano su misura.

Coffee table in 10 or 12 mm-thick curved glass with 10 or 12 mm-thick glass shelf. Also available in extralight glass and customized sizes.

Table basse en verre cintré de 10 mm ou 12 mm. Avec étagère en verre de 10 ou 12 mm. Disponible aussi en verre extralight et sur mesure.

Couchtisch aus 10 oder 12 mm-starkem gebogenem Glas mit 10 oder 12 mm-starker Glasablageplatte. Lieferbar auch aus extralight-Glas. Der Rialto piano kann nach Maß bestellt werden.

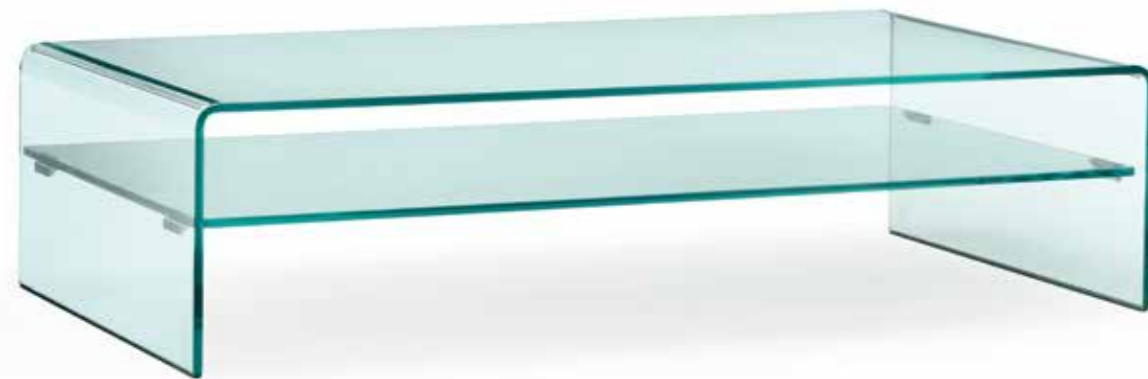

Tavolino.  
Coffee table.  
120 x 60 x 43 cm  
47 1/4" x 23 5/8" x 16 15/16"

## rialto side

DESIGN CRS FIAM

Tavolo di servizio in vetro curvato da 12 mm. Ripiano in vetro da 12 mm. Disponibile anche in vetro extralight. È possibile realizzare Rialto side su misura.

Side-table in 12 mm-thick curved glass. Shelf in 12 mm-thick glass. Also available in extralight glass and customized sizes.

Table d'appoint en verre cintré de 12 mm avec étagère en verre de 12 mm. Disponible aussi en verre extralight et sur mesure.

Beistelltisch mit Basis aus 12 mm-starkem gebogenem Glas mit Einlegeboden aus 12 mm-starkem Glas. Lieferbar auch aus extralight-Glas. Der Rialto side kann nach Maß bestellt werden.



Tavolino.  
Side table.  
85 x 32 x 55 cm  
33 7/16" x 12 5/16" x 21 5/16"



## rialto tris

DESIGN CRS FIAM

Composizione di tavoli bassi in vetro curvato da 10 mm. Disponibile anche in vetro extralight e NERO 95 o in vetro bronzo retroargentato. È possibile realizzare Rialto tris su misura.

Set of coffee tables in 10 mm-thick curved glass. Also available in extralight glass, Black 95 (NERO 95) glass or back-silvered bronze glass and in customized sizes.

Composition de tables basses en verre cintré de 10 mm. Disponible aussi en verre extra-clair, verre Noir95, verre bronze ou verre bronze dessous argenté.

Komposition von Couchtischen aus gebogenem Glas 10 mm. Auch in den folgenden Ausführungen lieferbar: extralight Glas oder Schwarz95 Glas oder Bronzeglas oder versilbertes Bronzeglas.

Vetro bronzo retroargentato.  
Back-silvered bronze glass.

39,5 x 40 x 37,5 cm  
15 <sup>9</sup>/<sub>16</sub>" x 15 <sup>3</sup>/<sub>4</sub>" x 14 <sup>3</sup>/<sub>4</sub>"

47,5 x 45 x 41,5 cm  
18 <sup>11</sup>/<sub>16</sub>" x 17 <sup>11</sup>/<sub>16</sub>" x 16 <sup>5</sup>/<sub>16</sub>"

55,5 x 50 x 45,5 cm  
21 <sup>7</sup>/<sub>8</sub>" x 19 <sup>11</sup>/<sub>16</sub>" x 17 <sup>15</sup>/<sub>16</sub>"





## charlotte

DESIGN PROSPERO RASULO

Tavolo basso in vetro curvato da 10 o 12 mm. Disponibile anche in vetro extralight. Ripiano opzionale in vetro curvato da 6 mm acidato.

Coffee table in 10 or 12 mm-thick curved glass. Also available in extralight glass. Optional shelf in 6 mm-thick acid-etched curved glass.

Table basse en verre cintré de 10 ou 12 mm. Disponible aussi en verre extralight. Etagère en verre cintré dépoli de 6 mm. sur demande.

Couchtisch aus 10 oder 12 mm-starkem gebogenem Glas. Lieferbar auch aus extralight-Glas. Auf Wunsch: Fachboden aus 6 mm-starkem gebogenem und geätzttem Glas.

Tavolino con ripiano.  
Coffee table with shelf.

120 x 60 x 40 cm  
47 1/4" x 23 5/8" x 15 3/4"



# ponte

DESIGN ANGELO CORTESI

Tavolino monolitico  
in vetro curvato  
da 10, 12 o 19 mm.

Monolithic coffee table  
in 10, 12 or 19 mm-thick  
curved glass.

Table basse d'une seule  
dalle de verre cintré  
de 10, 12 o 19 mm.

Couchtisch aus 10,  
12 oder 19 mm-starkem  
gebogenem Glas.

Tavolino.  
Coffee table.  
130 x 70 x 40 cm  
51 <sup>3</sup>/<sub>16</sub>" x 27 <sup>9</sup>/<sub>16</sub>" x 15 <sup>3</sup>/<sub>4</sub>"





## sigmy

DESIGN AQUILI - ALBERG

Tavolo di servizio in vetro curvato da 12 mm per la versione vetro trasparente o extralight, 10 mm per la versione Nero 95.

Side table in curved glass of 12 mm for the transparent or extralight glass version and 10 mm for the Black 95.

Table d'appoint en verre cintré de 12 mm pour la version en verre transparent ou extralight, de 10 mm pour la version Noir 95.

Beistelltisch aus 12 mm starkem, gebogenem, transparentem oder Extralight Glas, 10 mm starkem Glas Schwarz 95.

Tavolino.  
Side table.

46 x 46 x 55 cm  
18 1/8" x 18 1/8" x 21 5/8"

46 x 46 x 65 cm  
18 1/8" x 18 1/8" x 25 9/16"



# toki

DESIGN SETSU E SHINOBU ITO



Comodino monolitico  
in vetro curvato da 10 mm.

Monolithic bedside  
table in 10 mm-thick  
curved glass.

Chevet d'une seule  
dalle de verre cintré  
de 10 mm.

Nachttisch aus  
10 mm-starkem gebogenem  
Glas, aus einer einzigen  
Glasplatte gefertigt.

Tavolino / comodino.  
Side table / bedside table.

52 x 43 x 60 cm  
20 1/2" x 16 15/16" x 23 5/8"



toki 260.261



# grillo

DESIGN VITTORIO LIVI

Comodino in vetro  
curvato da 12 mm.

Bedside table  
in 12 mm-thick  
curved glass.

Chevet en verre  
cintré de 12 mm.

Nachttisch aus  
12 mm-starkem  
gebogenem Glas.

Tavolino / comodino.  
Side table / bedside table.  
53 x 42 x 60 cm  
20 7/8" x 16 9/16" x 23 5/8"



# magique

DESIGN STUDIO KLASS



Struttura in vetro extralight.  
Cubo contenitore in vetro  
fumè e bianco opale.

Extralight glass structure.  
Smoke and opal white glass  
inner compartment.

32 x 32 x 56 cm  
12 5/8" x 12 5/8" x 22 1/16"

# magique

DESIGN STUDIO KLASS

Tavolino con cubo  
contenitore  
in vetro da 10 mm.  
Disponibile  
in diverse finiture.

Coffee table  
with cubic inner  
compartment  
in 10 mm-thick  
glass. Available  
in various finishes.

Table d'appoint  
avec cube-rangement  
en verre soudé  
de 10 mm. Disponible  
en plusieurs finitions.

Beistelltisch mit Behälter  
aus 10 mm starkem,  
geschweißtem Glas.  
Lieferbar  
in diversen Finishes.





# magique

DESIGN STUDIO KLASS

Struttura in vetro extralight.  
Cubo contenitore in vetro blu.

Extralight glass structure.  
Blue glass inner compartment.

32 x 32 x 56 cm  
12 5/8" x 12 5/8" x 22 1/16"



charlotte de nuit	280
dino	272
grillo	284
magique cubo	288
milo	286
rialto night	276
toki	282

A photograph of a bedroom interior, featuring a bed with a tufted headboard, a bedside table, and a floor lamp. The scene is dimly lit, with light coming from a window in the background. The text is overlaid on the right side of the image.

# COMODINI BEDSIDE TABLES TABLES DE CHEVET NACHTTISCHE



# dino

DESIGN CRS FIAM

Comodino in vetro curvato da 8 mm con cassetto in legno laccato colore bianco, nero o testa di moro e frontalino in vetro da 8 mm verniciato in tinta.

Bedside table in 8 mm-thick curved glass with lacquered wood drawer white, black or dark brown. Front panel in 8 mm glass painted in matching colours.

Chevet en verre cintré de 8 mm avec tiroir en bois laqué blanc, noir ou marron et façade en verre de 8 mm verni de la même couleur.

Beistelltisch aus gebogenem Glas 8 mm und lackierte Holzschublade in den folgenden Farbvarianten erhältlich: weiß, schwarz, dunkelbraun. 8 mm lackierte Glasfront.

Comodino in vetro trasparente con cassetto laccato bianco.  
Bedside table in transparent glass with white lacquered drawer.

45 x 46 x 50 cm  
17 11/16" x 18 1/8" x 19 1/16"

# dino

DESIGN CRS FIAM

Comodino in vetro trasparente  
con cassetto laccato  
marrone testa di moro.  
Bedside table in transparent glass  
with dark brown lacquered drawer.

45 x 46 x 50 cm  
17 11/16" x 18 1/8" x 19 11/16"



# rialto night

DESIGN CRS FIAM

Comodino in vetro curvato da 8 mm. Disponibile con ripiano in vetro da 8 mm o con cassetto in finitura legno nelle varianti: rovere tabacco, olmo o laccato bianco.

Bedside table in 8 mm-thick curved glass. Available with 8 mm-thick glass shelf or with wood drawer, finish: tobacco oak, elm or white lacquered.

Table de chevet en verre cintré de 8 mm. Disponible avec étagère en verre de 8 mm. ou avec tiroir en bois finition : chêne coloris tabac, orme ou laqué blanc.

Nachttisch aus 8 mm-starkem gebogenem Glas. Verfügbar mit Fachboden aus 8 mm starkem Glas oder mit Schublade Finish: Steineichholz Tabak, Ulme oder lackiert Weiß.

Comodino con cassetto in legno laccato bianco. Bedside table with wood drawer, white lacquered finish.

47,5 x 45 x 45 cm  
18 1/16" x 17 1/16" x 18 1/16"



# rialto night

DESIGN CRS FIAM



Comodino con cassetto  
in legno finitura rovere tabacco.  
Bedside table with wood drawer,  
tobacco oak finish.

47,5 x 45 x 45 cm  
18 11/16" x 17 11/16" x 18 11/16"



# charlotte de nuit

DESIGN PROSPERO RASULO

Comodino in vetro curvato da 8 mm. Ripiano opzionale in vetro curvato acidato da 6 mm. Disponibile anche in vetro extralight.

Bedside table in 8 mm-thick curved glass. Also available in extralight glass. Optional shelf in 6 mm-thick acid-etched curved glass.

Table de chevet en verre cintré de 8 mm. Disponible aussi en verre extralight. Etagère en verre cintré dépoli de 6 mm. sur demande.

Nachttisch aus 8 mm-starkem gebogenem Glas. Lieferbar auch aus extralight-Glas. Auf Wunsch: Einlegeboden aus geätztem 6 mm-starkem gebogenem Glas.

Comodino con ripiano.  
Bedside table with shelf.

51 x 40 x 54 cm  
20 1/16" x 15 3/4" x 21 1/4"



# toki

DESIGN SETSU & SHINOBU ITO

Comodino monolitico  
in vetro curvato da 10 mm.

Monolithic bedside  
table in 10 mm-thick  
curved glass.

Table de chevet  
d'une seule dalle  
de verre cintré  
de 10 mm.

Nachttisch aus  
10 mm-starkem gebogenem  
Glas, aus einer einzigen  
Glasplatte gefertigt.

Tavolino / comodino.  
Side table / bedside table.  
52 x 43 x 60 cm  
20 1/2" x 16 15/16" x 23 5/8"



# grillo

DESIGN VITTORIO LIVI

Comodino in vetro  
curvato da 12 mm.

Bedside table  
in 12 mm-thick  
curved glass.

Table de chevet  
en verre cintré  
de 12 mm.

Nachttisch aus  
12 mm-starkem  
gebogenem Glas.

Tavolino / comodino.  
Side table / bedside table.  
53 x 42 x 60 cm  
20 <sup>7</sup>/<sub>8</sub>" x 16 <sup>9</sup>/<sub>16</sub>" x 23 <sup>5</sup>/<sub>8</sub>"





# milo

DESIGN ILARIA MARELLI

Comodino con struttura in vetro curvato da 8 mm trasparente o fumé. Dotazione: ripiano in vetro da 8 mm trasparente o fumé, retroverniciato nero o extralight retroverniciato bianco, cassetto in legno laccato bianco o nero con frontale in vetro. Reggipiani in vetro. Il comodino può essere dotato di 2, 3 ripiani oppure 2 ripiani ed un cassetto. Disponibile anche in vetro extralight.

Bedside table in curved transparent or smoked glass, 8 mm-thick. Accessories: 8 mm-thick glass shelf in the following finishing options: transparent or smoked glass, black back-stained glass, extralight white back-stained glass; wooden drawer black or white lacquered, with glass front back-stained respectively black or white. Glass shelf supports. The bedside table can be fitted with 2,3 shelves or 2 shelves and one drawer. Also available in extralight glass.

Table de chevet en verre cintré de 8 mm transparent ou fumé, étagères en verre de 8 mm transparent ou fumé, verni dessous noir ou extralight verni dessous blanc, tiroir en bois teinté blanc ou noir avec frontal en verre verni aussi blanc ou noir. Supports étagère en verre. Le chevet peut être équipé de 2, 3 étagères ou de 2 étagères et un tiroir. Disponible aussi en verre extralight.

Nachttisch aus gebogenem, transparentem- oder Rauch-Glas, 8 mm Stärke. Ausrüstung: 8 mm-starkem Glasfachboden aus transparentem- oder Rauch-Glas, schwarz-lackiertem Glas, extralight weiss-lackiertem Glas; Holzschublade schwarz oder weiss lackiert mit entsprechend Glasfront schwarz oder weiss. Fachbodenträger aus Glas. Der Nachttisch kann mit 2, 3 Fachböden bzw. 2 Fachböden und einer Schublade ausgestattet werden. Lieferbar auch aus extralight-Glas.

Comodino.  
Bedside table.

45 x 45 x 50 cm  
17 1/16" x 17 1/16" x 19 1/16"

# magique cubo

DESIGN STUDIO KLASS

Comodino con cubo  
contenitore in vetro  
saldato da 10 mm  
disponibile  
in diverse finiture.

Bedside table with  
cubic inner compartment  
in 10-mm thick welded  
glass. Available  
in various finishes.

Chevet avec cube  
rangement en verre  
soudé de 10 mm  
disponible dans  
plusieurs finitions.

Beistelltisch  
mit offener Cube-Box  
aus 10mm starkem  
geschweißtem Glas  
in diversen Finishes.



Struttura in vetro extralight.  
Cubo contenitore in vetro bronzo.  
Extralight glass structure.  
Bronze glass inner compartment.

38 x 34 x 48 cm  
15" x 13 3/8" x 18 7/8"



charlotte	308
dama	306
elementare	316
hype	294
let me see	310
LLT consolle	304
lunar	300
rialto consolle	314
waves	290



CONSOLLE  
CONSOLES  
CONSOLES  
KONSOLE



## waves

DESIGN LUDOVICA + ROBERTO PALOMBA

Consolle con piano  
in DV Glass da 23 mm  
trasparente o a strisce  
colorate. Base in metallo  
finitura Titanio opaco  
oppure Nichel Nero lucido.

Consolle composed  
of a 23 mm DV Glass top,  
available in transparent  
or in colored striped glass.  
Metal base available  
in opaque Titanium  
or in Black Glossy  
Nickel finishes.

Console avec plateau  
en DV Glass de 23 mm  
transparent ou avec  
bandes colorées.  
Base en métal finition  
Titane opaque  
ou Nickel noir brillant.

Konsole mit Platte  
aus DV Glass, Stärke 23 mm  
in der Ausführung Transparent  
oder mit farbigen Streifen  
erhältlich. Untergestell  
aus Metall in den  
Farbvarianten matt Titan  
oder glanz Schwarz Nickel.

# waves

DESIGN LUDOVICA + ROBERTO PALOMBA



Piano in DV-Glass colorato  
Base finitura nichel nero lucido.  
Colored DV-Glass top  
Black glossy nickel finish base.

150 x 45 x 75 cm  
59" x 17 11/16" x 29 1/2"



# hype

DESIGN STUDIO KLASS

Consolle con piano in vetro da 12 mm fuso a gran fuoco, temperato e retroverniciato con tinte metallizzate Grigio Lava, Marrone Ramato o Champagne. Base in metallo verniciato, finitura Grigio Lava.

Console with 12 mm fused, tempered and back-lacquered glass top with metal shades Lava Grey, Copper Brown or Champagne. Metal painted base, "Lava Grey" finish.

Console avec plateau en verre en fusion de 12 mm, trempé et verni dessous avec des teintes métallisées Gris Lave, Cuivre Marron ou Champagne. Base en métal verni, finition Gris Lave.

Konsole mit Platte aus 12 mm geschmolzenem und gehärtetem Glas in den folgenden Metallfarben unterlackiert: Lavagrau, Kupfer braun oder champagnerfarbig. Untergestell aus Metall in der Farbvariante Lavagrau.

hype

DESIGN STUDIO KLASS

Piano in vetro fuso  
finitura champagne.

Fused glass top  
champagne finish.

180 x 45 x 75 cm  
70 7/8" x 17 1/8" x 29 1/2"



hype

DESIGN STUDIO KLASS

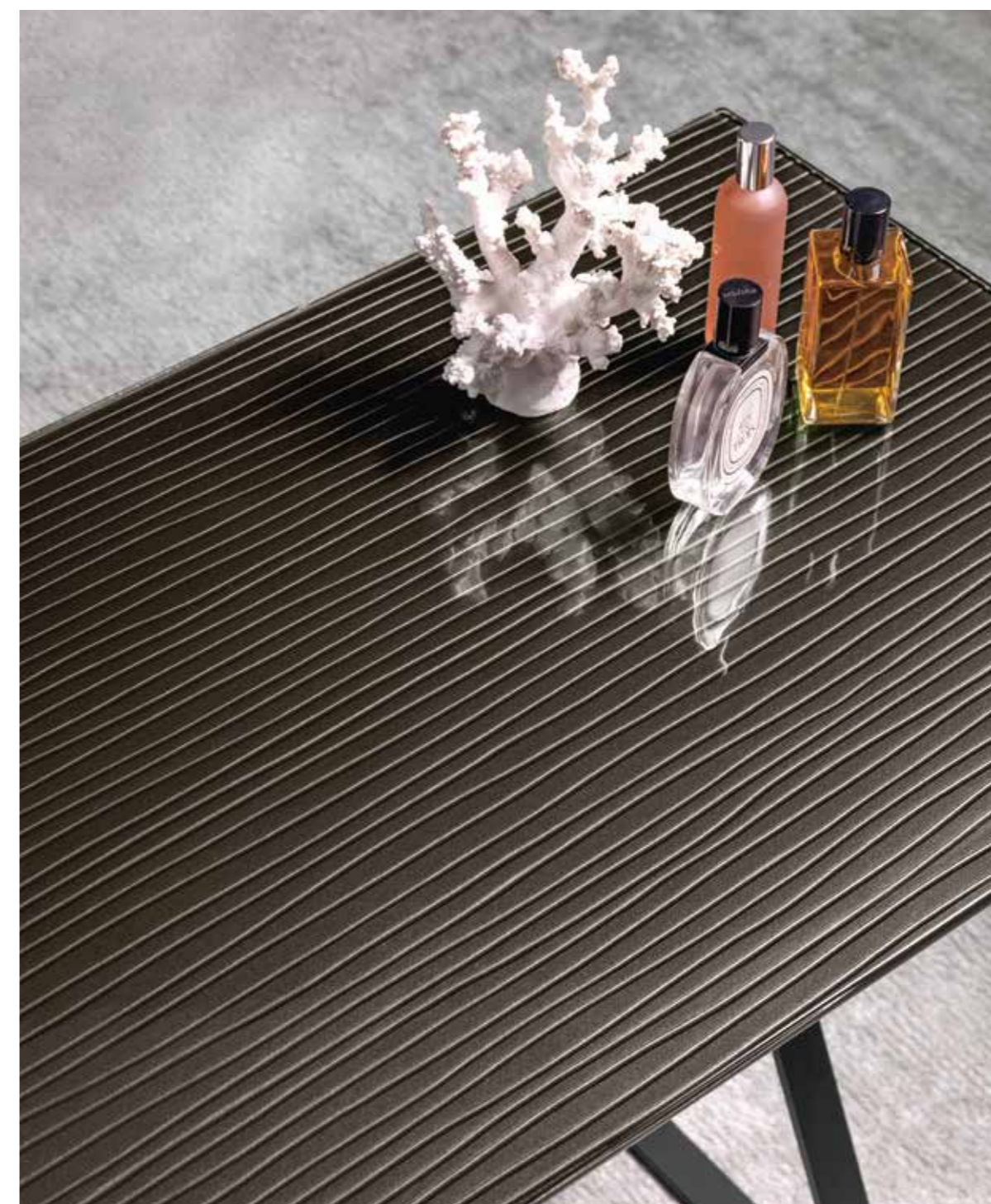

Piano in vetro fuso,  
finitura grigio lava.

Fused glass top,  
lava grey finition.

120 x 60 x 75 cm  
62" x 23 5/8" x 29 1/2"



# lunar

DESIGN MATTEO NUNZIATI

Piano in vetro fuso,  
finitura champagne.  
Fused glass top,  
champagne finition.

160 x 45 x 75 cm  
62" x 17 1/16" x 29 1/2"





# lunar

DESIGN MATTEO NUNZIATI

Consolle con piano in vetro da 12 mm fuso a gran fuoco, temperato e retroverniciato con tinte metallizzate Grigio Lava o Champagne. Base in metallo verniciato, finitura Grigio Lava.

Console with 12 mm fused, tempered and back-lacquered glass top with metal shades Lava Grey or Champagne. Metal painted base, "Lava Grey" finish.

Console avec plateau en verre en fusion de 12 mm, trempé et verni dessous avec des teintes métallisées Gris Lave ou Champagne. Base en métal verni, finition Gris Lave.

Konsole mit Platte aus geschmolzenem und gehärtetem Glas 12 mm in den Metallfarben Lava Grau oder Champagner erhältlich. Untergestell aus Metall in der Farbvariante Lavagrau.

# LLT consolle

DESIGN DANTE O. BENINI E LUCA GONZO

Consolle con piano in vetro trasparente da 15 mm con bisellatura su due lati corti, struttura gambe in vetro trasparente saldato da 15 mm con bisellatura da 30 mm sul bordo. Particolari di fissaggio in acciaio inox. Disponibile anche su misura fino ad una lunghezza di 240 cm.

Console composed of a 15 mm thick transparent glass top with bevelled edges on the two shorter sides and of a base in 15 mm thick transparent welded glass with bevelled edge. Fastening elements in stainless steel. LLT Consolle is also available with custom-sized top up to 240 cm length.

Console se composant d'un plateau en verre transparent de 15 mm avec biseautage sur les deux côtés courts et d'un piétement en verre transparent soudé, épaisseur 15 mm, avec bords biseautés. Éléments de fixation en acier inoxydable. Également disponible avec plateau su mesure jusqu'à la longueur de 240 cm.

Konsole mit Platte aus transparentem 15 mm starkem Glas, Facettenschliff auf den zwei kürzeren Seiten. Untergestell aus transparentem 15 mm starkem verschweisstem Glas, 30 mm Facettenschliff auf den Kanten. Verbindungselemente aus Edelstahl. Auch mit Maßgefertigter Platte erhältlich bis max. Länge 240 cm.

Consolle.  
Console.

180 x 40 x 85 cm  
70 7/8" x 15 3/4" x 33 7/16"



# dama

DESIGN MAKIO HASUIKE

Consolle monolitica  
in vetro curvato  
da 12 mm.

Monolithic console  
in 12 mm-thick  
curved glass.

Console d'une seule  
dalle de verre cintré  
de 12 mm.

Konsole aus 12 mm-starkem  
gebogenem Glas,  
aus einer einzigen  
Glasplatte gefertigt.

Consolle.  
Console.

130 x 43 x 85 cm  
51 <sup>3</sup>/<sub>16</sub>" x 16 <sup>15</sup>/<sub>16</sub>" x 33 <sup>7</sup>/<sub>16</sub>"



# charlotte

DESIGN PROSPERO RASULO

Consolle in vetro curvato da 15 mm. Disponibile anche in vetro extralight. Ripiano optional in vetro curvato ed acidato da 6 mm.

Console in 15 mm-thick curved glass. Also available in extralight glass. Optional 6 mm-thick acid-etched curved glass shelf.

Console en verre cintré de 15 mm. Disponible aussi en verre extralight. Étagère sur demande en verre cintré dépoli de 6 mm.

Konsole aus 15 mm-starkem gebogenem Glas. Lieferbar auch aus extralight-Glas. Auf Wunsch: Fachboden aus geätzttem gebogenem 6 mm-starkem Glas.



Consolle.  
Console.

112 x 36 x 80 cm  
44 1/8" x 14 3/16" x 31"



# let me see

DESIGN RODOLFO DORDONI

Specchio consolle  
con ripiano in vetro  
curvato da 8 mm.  
Cornice in acciaio  
inox satinato.

Mirror console  
in 8 mm-thick  
curved glass.  
Frame in glazed  
stainless steel.

Miroir console  
avec étagère  
en verre cintré  
de 8 mm.  
Cadre en acier  
inox satiné.

Spiegel Konsole mit  
Ablage aus 8 mm-starkem  
gebogenem Glas.  
Rahmen aus rostfreiem  
satinierem Stahl.



## let me see

DESIGN RODOLFO DORDONI

Specchio onsole.  
Console mirror.  
120 x 36 x 195 cm  
47 1/4" x 14 3/16" x 76 3/4"



# rialto consolle

DESIGN CRS FIAM

Consolle in vetro curvato da 12 mm. Disponibile anche con ripiano in vetro da 10 mm e in vetro extralight.

Console in 12 mm-thick curved glass. Also available with 10 mm-thick glass shelf and in extralight glass.

Console en verre cintré de 12 mm. Disponible aussi avec étagère en verre de 10 mm et en verre extralight.

Konsole aus 12 mm-starkem gebogenem Glas. Auch mit Fachboden aus 10 mm-starkem Glas und aus extralight Glas lieferbar.

Consolle in vetro extralight.  
Console in extralight glass.

140 x 36 x 75 cm  
55 1/8" x 14 3/16" x 29 1/2"





# elementare

DESIGN ENRICO TONUCCI

Consolle in vetro curvato da 12 mm. Disponibile anche con ripiano in vetro da 10 mm e in vetro extralight.

Console in 12 mm-thick curved glass. Also available with 10 mm-thick glass shelf and in extralight glass.

Console en verre cintré de 12 mm. Disponible aussi avec étagère en verre de 10 mm et en verre extralight.

Konsole aus 12 mm-starkem gebogenem Glas. Auch mit Fachboden aus 10 mm-starkem Glas und aus extralight Glas lieferbar.

Consolle con ripiano.  
Console with shelf.  
120 x 36 x 76 cm  
47 1/4" x 14 3/16" x 29 5/16"



bacall	346
brigitte	354
callas	342
dress	350
easy lloyd	324
kamy	338
lloyd	320
magma	328
plié	332



SEDIE  
CHAIRS  
CHAISES  
STÜHLE



**lloyd**

DESIGN STUDIO KLASS

Rivestimento in pelle nera  
struttura in legno  
laccato nero a poro aperto.  
Black leather-upholstered  
open pore black laquered  
wood structure.

Tavolo Hype.  
Hype table.

# lloyd

DESIGN STUDIO KLASS

Sedia con struttura in legno massello disponibile nelle finiture rovere tabacco o laccato nero a poro aperto. Seduta e schienale rivestiti in pelle.

Chair with solid wood structure, available in tobacco oak or in open pore black laquered finishes. Seat and backrest are leather-upholstered.

Chaise avec structure en bois massif disponible dans les finitions chêne tabac ou laqué noir à pore ouvert. Assise et dossier revêtus en cuir.

Stuhl mit Struktur aus massiven Holz in den folgenden Ausführungen: Eiche Tabak oder offenporig schwarz lackiert. Sitzfläche und Rücklehne mit Lederbezug.



Rivestimento in pelle testa di moro, struttura in legno finitura rovere tabacco.

Dark brown leather upholster tobacco oak finish wood structure.

Tavolo Big wave.  
Big wave table.



## easy lloyd

DESIGN STUDIO KLASS

Rivestimento in pelle nera  
struttura in legno  
laccato nero a poro aperto.

Black leather-upholstered  
open pore black laquered  
wood structure.

Tavolo Coral Beach.  
Coral Beach table.





## easy lloyd

DESIGN STUDIO KLASS

Sedia con struttura in legno massello disponibile nelle finiture rovere tabacco o laccato nero a poro aperto. Seduta e schienale rivestiti in pelle.

Chair with solid wood structure, available in oak tobacco, or in open pore glossy black painted finishes. Seat and backrest are leather-upholstered.

Chaise avec structure en bois massif disponible dans les finitions chêne tabac ou laqué noir à pore ouvert. Assise et dossier revêtus en cuir.

Stuhl mit Struktur aus massiven Holz in den folgenden Ausführungen: Eiche Tabak oder offenporig schwarz lackiert. Sitzfläche und Rücklehne mit Lederbezug.



Rivestimento in pelle testa di moro, struttura in legno finitura rovere tabacco.

Dark brown leather upholster tabacco oak finish wood structure.

Tavolo Theo.  
Theo table.



## magma

DESIGN PATRICK JOUIN

Rivestimento in pelle nera,  
struttura in legno  
finitura rovere tinto grigio.

Black leather upholster,  
grey oak finish wood structure.

Tavolo Magma.  
Magma table.

# magma

DESIGN PATRICK JOUIN

Sedia con struttura in legno massello disponibile nelle finiture rovere naturale o tinto grigio. Seduta e schienale rivestiti in pelle.

Chair with solid wood structure, available in natural or grey oak finish. Seat and backrest are leather-upholstered.

Chaise avec structure en bois massif disponible dans les finitions chêne naturel ou de couleur grise. Assise et dossier revêtus en cuir.

Stühl mit Struktur aus massiven Holz in den folgenden Ausführungen: Eiche Natur oder grau lackiert. Sitzfläche und Rücklehne mit Lederbezug.



Rivestimento in pelle testa di moro, struttura in legno finitura rovere naturale.  
Dark brown leather upholstery, natural oak finish wood structure.

Tavolo Magma.  
Magma table.







Sedia, cuoio nero  
e pelle testa di moro.  
Chair, hide black  
and leather dark brown.

Collezione Plié  
(tavolo, madia, sedia).  
Plié collection  
(table, cupboard, chair).

# plié

DESIGN STUDIO KLASS

Sedia rivestita in cuoio e pelle con struttura interna in tubolare metallico e legno.

Leather-upholstered chair with internal structure in tubular metal and wood.

Chaise recouverte en cuir avec structure interne en tube métallique et bois.

Stuhl mit Lederbezug und Innenstruktur aus Metall- und Holzrohren.



NERO U04  
FUMO F20

BLACK U04  
SMOKE F20

NERO U04  
TESTA DI MORO F41

BLACK U04  
DARK BROWN F41

NERO U04  
NERO F04

BLACK U04  
BLACK F04



TESTA DI MORO U41  
NERO F04

DARK BROWN U41  
BLACK F04

TESTA DI MORO U41  
TESTA DI MORO F41

DARK BROWN U41  
DARK BROWN F41

TESTA DI MORO U41  
FUMO F20

DARK BROWN U41  
SMOKE F20

plié

DESIGN STUDIO KLASS

Sedia, cuoio testa di moro  
e pelle fumo.  
Chair, hide dark brown  
and leather smoke.

Tavolo Plié.  
Plié table.



kamy  
DESIGN SETSU & SHINOBU ITO



# kamy

DESIGN SETSU & SHINOBU ITO

Sedia impilabile  
rivestita completamente  
in pelle sfoderabile.  
Struttura in tubolare  
metallico schiumato  
con gomme  
poliuretatiche espanse.  
Disponibile nei colori:  
bianco, nero e marrone.

Stacking chair  
with removable  
leather upholstery.  
Tubular metal structure  
with expanded  
polyurethane  
rubber foam.  
Available in white,  
black and brown.

Chaise empilable  
entièrement recouverte  
de cuir déhoussable.  
Structure en tube  
métallique rempli  
de caoutchouc  
de polyuréthane expansé.  
Disponibile dans  
les couleurs : blanc,  
noir et marron.

Stapelbarer Stuhl  
mit abziehbarer  
Lederhülle.  
Mit PUR ausgeschäumte  
Metallrohrstruktur.  
Lieferbar in den  
Farben Weiß,  
Schwarz und Braun.



NERO  
BLACK

MARRONE  
BROWN

BIANCO  
WHITE

callas

DESIGN THIS WEBER



# callas

DESIGN THIS WEBER

Sedia rivestita in cuoio con struttura interna in tubolare metallico. Disponibile nei colori: testa di moro, grigio cenere, bianco, nero.

Leather-upholstered chair with internal structure in tubular metal. Available in dark brown, grey ash-colour, white, black.

Chaise recouverte de cuir avec une structure interne en tube métallique. Disponible dans les coloris: marron, gris cendreau, blanc, noir.

Stuhl mit Lederbezug und Innenstruktur aus Metallrohren. Lieferbar in den Farben Dunkelbrown, Aschgrau, Weiß, Schwarz.



TESTA DI MORO  
DARK BROWN

GRIGIO CENERE  
ASH GREY



BIANCO  
WHITE



NERO  
BLACK

**bacall**

DESIGN THIS WEBER





# bacall

DESIGN THIS WEBER

Sedia rivestita in cuoio con struttura interna in tubolare metallico e legno. Disponibile nei colori: bianco, nero, testa di moro e grigio cenere.

Leather upholstered chair with internal structure in tubular metal and wood. Available in the following colours: white, black, dark brown and ash grey.

Chaise recouverte en cuir avec structure interne en tube métallique et bois. Disponible dans les coloris: blanc, noir, marron et gris cendré.

Stuhl mit Lederbezug und Innenstruktur aus Metall- und Holzrohren. Verfügbar in den Farben: Weiß, Schwarz, Dunkelbraun und Aschgrau.



BIANCO  
WHITE



GRIGIO CENERE  
ASH GREY



TESTA DI MORO  
DARK BROWN



NERO  
BLACK

# dress

DESIGN ARCHIRIVOLTO



# dress

DESIGN ARCHIRIVOLTO

Sedia rivestita in cuoio con struttura interna in tubolare metallico e legno. Disponibile nei colori tinta unita standard bianco, marrone, nero, colori a richiesta su cartella colori. Disponibili anche in cuoio bicolore a scelta sulla cartella colori. Non impilabile.

Leather-upholstered chair with internal structure in tubular metal and wood. Available in the standard whole colours white, brown and black, and with custom colours from colour chart. Also available in two custom colours chosen from the colour chart. Not stacking.

Chaise revêtue en cuir avec structure interne en tube métallique et bois. Disponible dans les coloris teinte unie standard blanc, marron, noir, coloris sur demande sur carte des coloris. Egalement disponible en cuir bicolore au choix sur carte des coloris.

Stuhl mit Lederbezug und Innenstruktur aus Metallrohren und Holz. Lieferbar in den Farben Uni Standard Weiß, Braun, Schwarz, auf Anfrage auch in den Farben der Farbkarte, sowie mit zweifärbigem Lederbezug nach Wahl aus der Farbkarte.



BIANCO  
WHITE

NERO  
BLACK

TESTA DI MORO  
DARK BROWN

BICOLORE  
TWO COLOURS

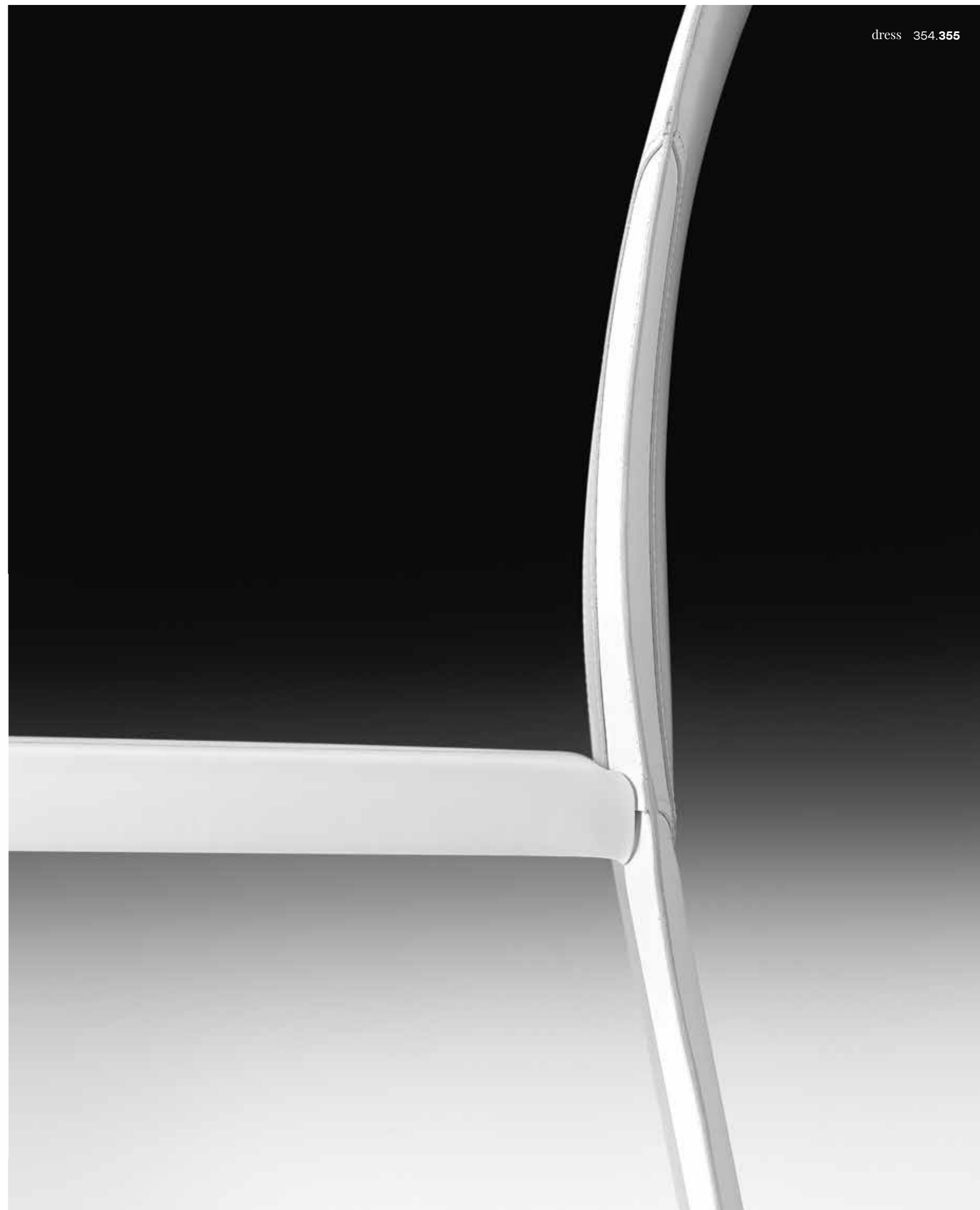



Sedia in pelle testa di moro.  
Chair in dark brown leather.  
Tavolo LLT.  
LLT table.

# brigitte

DESIGN FABIO DI BARTOLOMEI

Sedia a schienale alto rivestita in pelle con struttura interna in tubolare metallico e legno. Disponibile nei colori: bianco, nero e marrone.

High-back chair leather upholstered, with tubular metal and wood internal structure. Available in white, black and brown.

Chaise à dossier haut recouvert en cuir avec structure interne en tube de métal et bois. Disponible dans les coloris : blanc, noir et marron.

Hochlehner mit Kunstlederverkleidung und Innenstruktur aus Metallrohren und Holz. In den Farben Weiß, Schwarz und Braun.



BIANCO F05  
WHITE F05

TESTA DI MORO F41  
DARK BROWN F41

NERO F04  
BLACK F04

# mini collection

È noto che FIAM Italia, nella lavorazione del vetro curvato, può definirsi unica al mondo. Le sue creazioni rappresentano ormai storici "capolavori", originali per concezione progettuale, inimitabili per rigore stilistico e impeccabile esecuzione. L'idea di realizzare "miniature" dei prodotti storici FIAM Italia nasce nel 2000. L'intento è quello di proporre una collezione di opere in scala ridotta che testimoniano l'unicità del cristallo curvato oltre a dimostrare allo stesso tempo come tali opere, assunta una nuova veste e una nuova dimensione, possano continuare ad offrire un'alta carica espressiva capace di aggiungere bellezza, poesia ed un tocco di vita in più alle nostre case.

FIAM Italia's world-wide unique status in the processing of curved glass is universally acknowledged. Its creations have become historic masterpieces, original in their design concept, inimitable in their exquisite styling and impeccable craftsmanship. The idea of producing miniatures of FIAM Italia's most famous products dates from 2000. The aim was to offer a collection of works on a small scale that would illustrate the unique features of curved plate glass as well as proving that, even in a new form and size, these works still have a striking expressive charge, capable of adding beauty, poetry and a touch of extra life to our homes.

On sait que FIAM Italia, dans le travail du verre cintré, peut se considérer comme étant unique au monde. Ses créations sont des « chefs-d'oeuvre » historiques, dont la conception de projet est originale, et la rigueur stylistique et l'exécution impeccable inimitables. L'idée de réaliser des « miniatures » des produits historiques FIAM Italia est née en l'an 2000. L'intention était de proposer une collection de pièces à l'échelle réduite exprimant le caractère unique du cristal cintré et de démontrer que ces pièces, habillées d'une nouvelle présentation et d'une nouvelle dimension, pouvaient continuer à dégager une charge expressive en mesure d'ajouter de la beauté, de la poésie et une touche de vie à votre intérieur.

FIAM Italia ist auf der ganzen Welt für seine einzigartigen Produkte aus gebogenem Glas bekannt. Viele Kreationen von FIAM Italia gelten auf Grund ihres außergewöhnlichen Konzepts, ihres unnachahmbaren Stils und ihrer exzellenten Ausführung als wahre Meisterwerke des internationalen Designs. Die Idee, Miniaturmodelle dieser in die Geschichte des Designs eingegangenen Meisterwerke herzustellen, wurde bereits im Jahr 2000 geboren, mit der Absicht, eine Kollektion von maßstabgetreuen Modellen zu schaffen, die Zeugnis von der Einzigartigkeit des gebogenen Kristall-glases ablegen und gleichzeitig unter Beweis stellen, dass diese Meisterwerke auch in einer neuen Aufmachung und im Miniaturformat ihre ganze Ausdruckskraft beibehalten und unser Zuhause mit Schönheit, Poesie und einem Hauch von Leben bereichern.

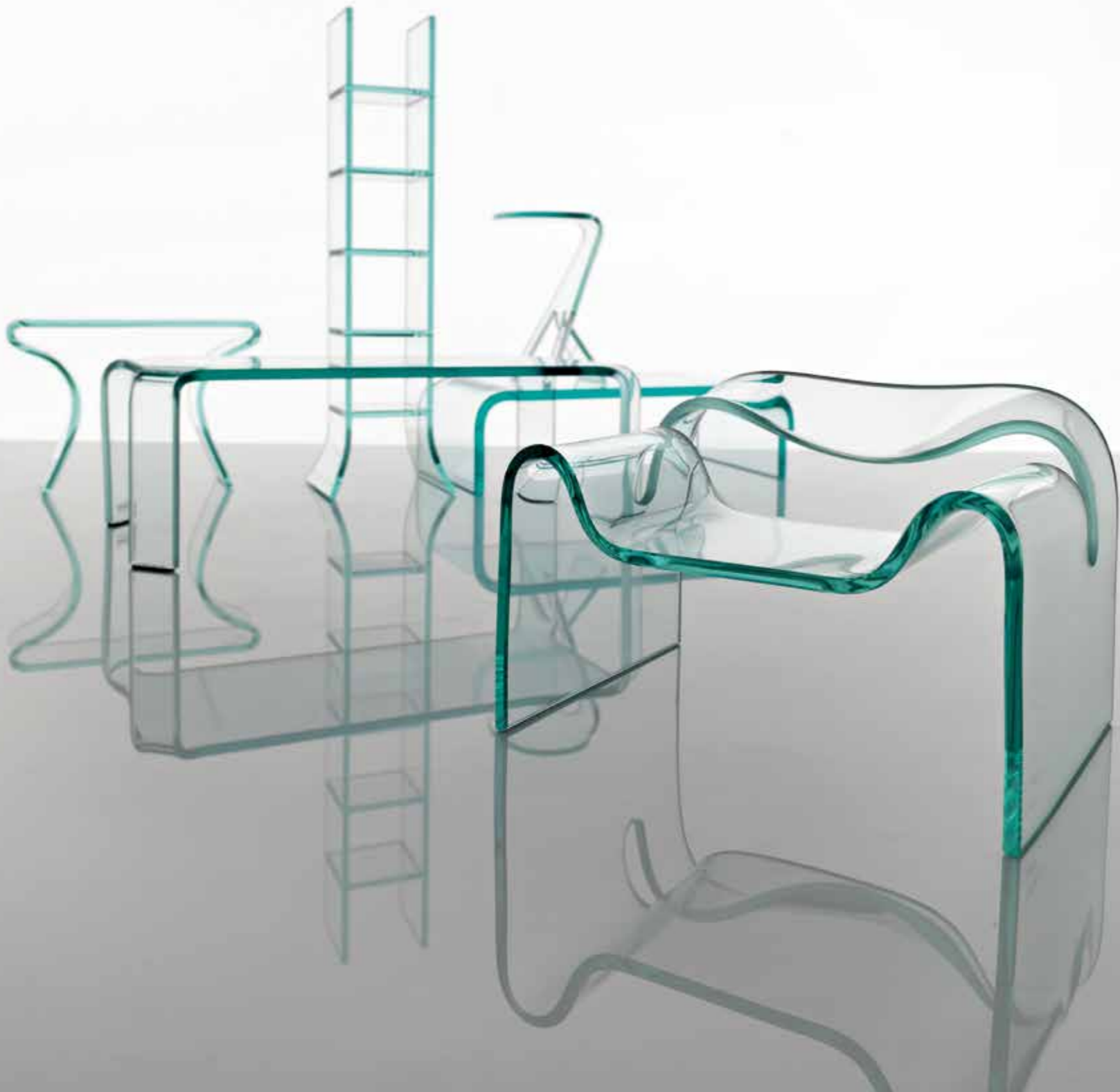

### ADMIRAL



H 27 cm  
ø 6 cm

### BABELE



H 34 cm  
L/W/L 9 cm  
P/D/T 9 cm

### MANTA



H 7 cm  
L/W/L 23 cm  
P/D/T 14 cm

### CHARLOTTE



H 11 cm  
L/W/L 17 cm  
P/D/T 5,5 cm

### COBRA



H 14 cm  
L/W/L 7 cm  
P/D/T 8,5 cm

### GHOST



H 11 cm  
L/W/L 17,5 cm  
P/D/T 15,5 cm

### GRILLO



H 12 cm  
L/W/L 10,5 cm  
P/D/T 8 cm

### ALVAR AALTO



H 10,5 cm  
ø 9 cm

### PONTE



H 8 cm  
L/W/L 26 cm  
P/D/T 14 cm

### RAGNO



H 10,5 cm  
L/W/L 30,5 cm  
P/D/T 16 cm

## Design su misura



I prodotti Custom-made Fiam, progettati da designer di fama mondiale, nascono per consentire ad una committenza esigente ed evoluta, di adattare complementi di grande prestigio alle proprie necessità. Fiam ha sperimentato l'efficacia di concepire il prodotto di design come oggetto dinamico e versatile, permettendo, a chi lo sceglie, di diventare co-autore di un'opera unica. In particolar modo, Rialto, Rialto L e Luxor, offrono varie possibilità di trasformazione di misura e assetto. Ogni pezzo è personalizzabile anche utilizzando complementi a cassettera scegliendo dimensioni, forme e finiture diverse. Dalla modularità del sistema Caadre, invece, si possono ottenere infinite soluzioni per arredare pareti, divisori e pannellature.

## Design sur mesure



Les produits Fiam sur mesure, conçus par des designers de renommée mondiale, ont été conçus pour un client exigeant et évolué lui permettant d'adapter des produits de grand prestige à ses propres besoins. Fiam a connu l'efficacité de la conception du produit comme un objet dynamique et polyvalent, ce qui permet, à ceux qui le choisissent, de devenir co-auteur d'une pièce unique. En particulier, Rialto, Rialto L et Luxor, offrent divers possibilités d'un traitement de mesure et de configuration. Chaque pièce est également personnalisable à l'aide de caissons à tiroirs où on peut choisir les tailles, formes et finitions différentes. La modularité du miroir Caadre cependant permet d'obtenir une infinité de solutions comme cloison, boiserie et pour décorer les murs.

## Custom-made design



Fiam Custom-made products, styled by world-famous designers, are intended to allow a discerning clientele at the leading edge of the market to adapt prestige items of furniture to their own specific needs. Fiam has proven the effectiveness of conceiving a designer product as a dynamic, versatile piece, giving clients the opportunity of becoming joint creators of a unique work of art. Rialto, Rialto L and Luxor, in particular, offer a variety of possibilities for transformation of their size and layout. Each piece can be customised, for example by completing it with a drawer unit with specially chosen size, shape and finish. The modular Caadre provide the basis for an infinite variety of compositions, for furnishing walls, partitions and panelling structures.

## Design nach Wunsch



Die Custom-made gefertigten Produkte von Fiam, von weltberühmten Designern entworfen, wurden entwickelt, um anspruchsvollen und bedeutenden Kunden die Möglichkeit zu bieten, wertvolle Stücke mit Prestige, ihren eigenen Bedürfnisse anzupassen. Fiam hat den Vorteil der Konzeption eines Design-Produkts als ein dynamisches und vielseitiges Objekt genutzt, das denjenigen, die es auswählen, zum Co-Autor eines einzigen Werks werden. Insbesondere die Modelle Rialto, Rialto L und Luxor, bieten verschiedene Möglichkeiten von Sondermasse und Ausführungen. Jedes Stück kann auch mit Schubladen ausgestattet werden, und bietet eine Auswahl von Sondergrößen, Formen und Ausführungen. Dank der Modularität des Caadre kann man unendlich viele Lösungen anbieten um Wände zu dekorieren, als Raumteiler oder als Vertäfelung.

I CUSTOMIZZABILI  
THE CUSTOMIZABLES  
LES PERSONNABISABLES  
DIE ANPASSBAREN

 **I Customizzabili**  
The Customizables  
Les personnalisables  
Die Anpassbaren

**TAVOLI**  
TABLES  
TABLES  
TISCHE



	ATLAS	BIG WAVE	CORAL BEACH	CORNER	EPSYLON	HYPE	KIGHI	LLT	LUXOR
Misure H. - P. - L. Dimensions H. - L.				•				•	•
Dimensione del Top Top dimension	•	•	•	•	•	•	•	•	•
Finiture vetro Glass finish		•		•	•				•
Laccatura Lacquering		•	•	•	•	•	•	•	•



	MAGMA	PLIÉ	RAY	SAHARA	THEO	WAVES
Misure H. - P. - L. Dimensions H. - L.						
Dimensione del Top Top dimension	•	•	•	•	•	•
Finiture vetro Glass finish		•		•		•
Laccatura Lacquering		•	•	•	•	•



## TAVOLI ALLUNGABILI

EXTENSIBLE TABLES  
TABLES À RALLONGE  
AUSZIEHTISCHE



	HYPE	KAYO	RAY PLUS	RIME	THEO	WAVES
Misure H. - P. - L. Dimensions H.-W.-L.						
Dimensione del Top Top dimension		•	•			
Finiture vetro Glass finish						•
Laccatura Lacquering	•	•	•	•	•	•

## TAVOLI MULTIMATERICI

MULTIMATERIAL  
TABLES  
TABLES  
MULTIMATERIEUX  
MULTIMATERIALIEN-  
TISCHE



	BIG WAVE	LLT WOOD	PLIÉ
Misure H. - P. - L. Dimensions H.-W.-L.	•	•	
Dimensione del Top Top dimension	•	•	
Finiture vetro Glass finish			•
Laccatura Lacquering			

# I Customizzabili

The Customizables

Les personnalisables

Die Anpassbaren

## TAVOLI BASSI

COFFEE TABLES

TABLES BASSES

COUCHTISCHE



	ATLAS	CANNAGE	CHARLOTTE	HYPE	LAKES	MAGMA	NEUTRA	PONTE	QUADRA
Misure H. - P. - L. Dimensions H. - L.	•								•
Dimensione del Top Top dimension				•					
Finiture vetro Glass finish			•				•	•	•
Laccatura Lacquering		•	•	•	•	•	•	•	•



	RIALTO (SQUARE, PIANO, TRIS)	ROY	SHELL	WAVES
Misure H. - P. - L. Dimensions H. - L.	•			
Dimensione del Top Top dimension		•		
Finiture vetro Glass finish	•	•	•	•
Laccatura Lacquering	•	•		

# I Customizzabili

The Customizables

Les personnalisables

Die Anpassbaren

## TAVOLI DI SERVIZIO

SIDE-TABLES  
TABLES D'APPOINT  
BEISTELLTISCHE

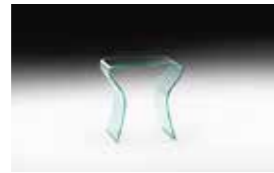

	CHARLOTTE DE NUIT	DINO	GRILLO	RIALTO (TRIS, SIDE, NIGHT)	TOKI	SIGMY
Misure H. - P. - L. Dimensions H. - L.				•		
Finiture vetro Glass finish	•	•	•	•	•	•
Laccatura Lacquering	•			•		

## CONSOLLE

CONSOLES  
CONSOLES  
KONSOLE



	CHARLOTTE	DAMA	ELEMENTARE	HYPE	LET ME SEE	LLT CONSOLE	LUNAR	RIALTO CONSOLLE	WAVES
Misure H. - P. - L. Dimensions H. - L.				•		•		•	•
Finiture vetro Glass finish	•	•	•		•	•		•	•
Laccatura Lacquering	•	•	•	•			•	•	

TAVOLI	atlas	375		rialto piano	421
TABLES	big wave	376		rialto side	422
	coral beach	378		rialto tris	423
	corner	379		roy	424
	epsylon	380		shell	425
	hype	382		sigmy	426
	kayo	384		toki	427
	kighi	387		waves	428
	LLT	388			
	LLT wood	390	COMODINI	charlotte de nuit	429
	luxor	391	BEDSIDE	dino	430
	magma	392	TABLES	grillo	431
	plié	394		magique cubo	432
	ragno	400		milo	433
	ray	396		rialto night	434
	ray plus	397		toki	435
	rime	398			
	sahara	401	CONSOLLE	charlotte	436
	theo	402	CONSOLES	dama	437
	waves	404		elementare	438
				hype	439
				let me see	441
				LLT consolle	442
				lunar	443
				rialto consolle	444
				waves	445
			SEDIE	bacall	446
			CHAIRS	brigitte	447
				callas	448
				dress	449
				easy lloyd	450
				kamy	451
				lloyd	452
				magma	453
				plié	454
TAVOLI BASSI E DI SERVIZIO	atlas	407			
COFFEE TABLES AND SIDE TABLES	cannage	408			
	charlotte	409			
	hype	410			
	lakes	411			
	macramè	412			
	macramè large	413			
	magique	414			
	magma	415			
	neutra	416			
	pixel	417			
	ponte	418			
	quadra	419			
	rialto	420			

SCHEDE  
TECNICHE  
TECHNICAL  
DATA SHEETS  
FICHES  
TECHNIQUE  
DATENBLÄTTER

## ghost

DESIGN  
CINI BOERI

Poltrona in vetro  
curvato da 12 mm.

Monolithic chair  
in 12 mm-thick  
curved glass.

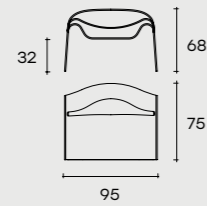

Fauteuil en verre cintré  
d'une seule dalle  
de verre de 12 mm.

Sessel aus gebogenem  
12 mm-starkem Glas,  
aus einer einzigen  
Glasplatte gefertigt.

95 x 75 x 68  
37 3/8 x 29 1/2" x 26 3/4"

## atlas

DESIGN  
DANNY LANE

Tavolo con piano  
in vetro temperato  
da 19 mm.

Gambe composte  
da sezioni di vetro  
scolpito a mano  
di spessore 19 mm  
ed incollate l'una  
sull'altra. Disponibile  
anche con piano  
su misura.

Table with tempered  
glass top 19 mm thick.  
Legs consisting in  
sections of hand-sculpted  
glass 19 mm thick, glued  
one on top of the other.  
Also available with  
custom-sized top.

Table avec plateau  
en verre trempé  
de 19 mm. Pieds  
composés de sections  
en verre sculpté  
à la main d'une  
épaisseur de 19 mm  
et collées l'une  
sur l'autre. Egalement  
disponible avec  
plateau sur mesure.

150 x 150 x 74 cm  
59 1/16" x 59 1/16" x 29 1/8"

220 x 100 x 74 cm  
87" x 39 3/8" x 29 1/8"

240 x 120 x 74 cm  
94 1/2" x 47 1/4" x 29 1/8"

Tisch mit 19 mm  
starker Platte aus  
gehärtetem Glas.  
Beine aus aufeinander  
geklebten, 19 mm  
starken, handbehauenen  
Glas-elementen. Auch  
mit maßgefertigter  
Platte erhältlich.

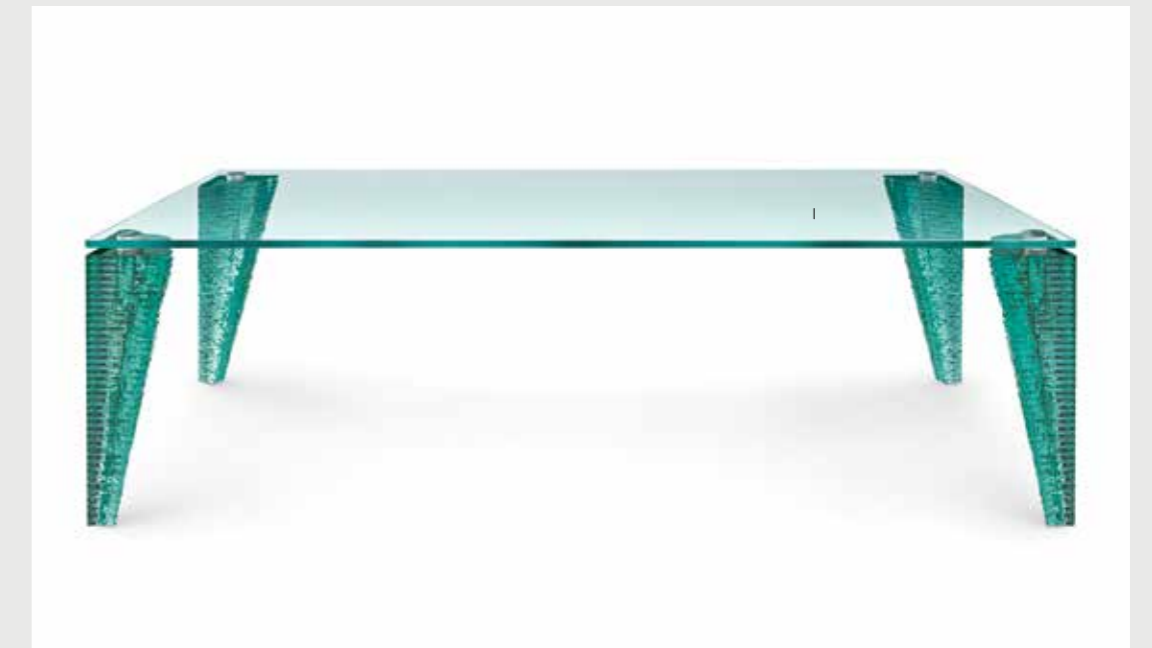
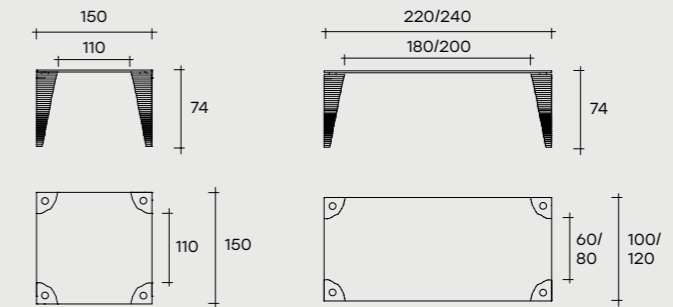

# big wave

DESIGN LUDOVICA  
+ ROBERTO PALOMBA



Tavolo con base composta da tre, quattro o sei elementi in DV Glass da 30 mm trasparente o a strisce colorate. Piano in vetro da 15 mm trasparente retroverniciato con tinte monocromatiche, oppure ricoperto in Ecomalta, spatolatura tipo fine, oppure in legno impiallacciato noce canaletto finitura antracite opaco.

Table with base made of three, four or six separate 30 mm DV Glass elements, transparent or with colored stripes. Top made of 15 mm transparent glass, back-lacquered with monochrome color or hand-finished with Ecomalta, finer-grained texture finish, or in Canaletto walnut veneered wood, matt anthracite finish.

Table avec base composée par trois, quatre ou six éléments en DV Glass de 30 mm, transparent ou avec bandes colorées. Plateau en verre de 15 mm transparent verni dessous avec teintes monochromes ou enduit finement à la main avec Ecomalta ou en bois plaqué noyer canaletto finition anthracite opaque.

Tisch bestehend aus drei, vier oder sechs Elementen aus DV Glas Stärke 30 mm in der Ausführung transparent oder mit farbigen Streifen. 15 mm Glasplatte in den folgenden Varianten: mit monochromatischen Farben unterlackiert oder mit Ecomalta bespachtelt zu einer feinen textilähnlichen Bearbeitung oder in Canaletto-Nussbaum furniertem Holz in der Farbvariante mattes anthrazit.

rettangolare / rectangular  
rectangulaire / Rechteckig

240 x 110 x 75 cm  
94 1/2" x 43 5/16" x 29 1/2"  
300 x 120 x 75 cm  
118 1/8" x 47 1/4" x 29 1/2"  
360 x 120 x 75 cm  
141 3/4" x 47 1/4" x 29 1/2"

con piano in legno:  
with wood top:

H 77 cm  
H 30 5/16"

tondo / round  
rond / Rund

Ø 140 x 75 cm  
Ø 55 1/8" x 30 1/8"  
Ø 158 x 75 cm  
Ø 62 3/16" x 30 1/8"  
Ø 180 x 75 cm  
Ø 70 7/8" x 30 1/8"

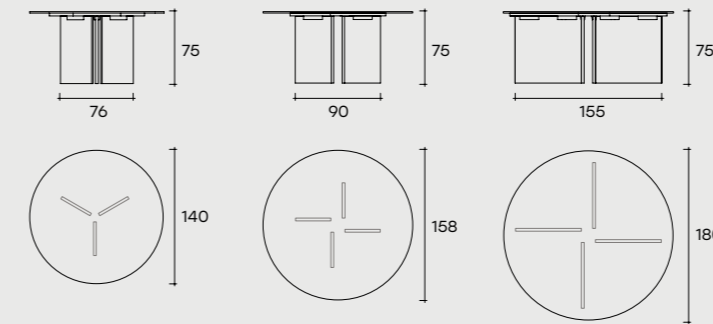
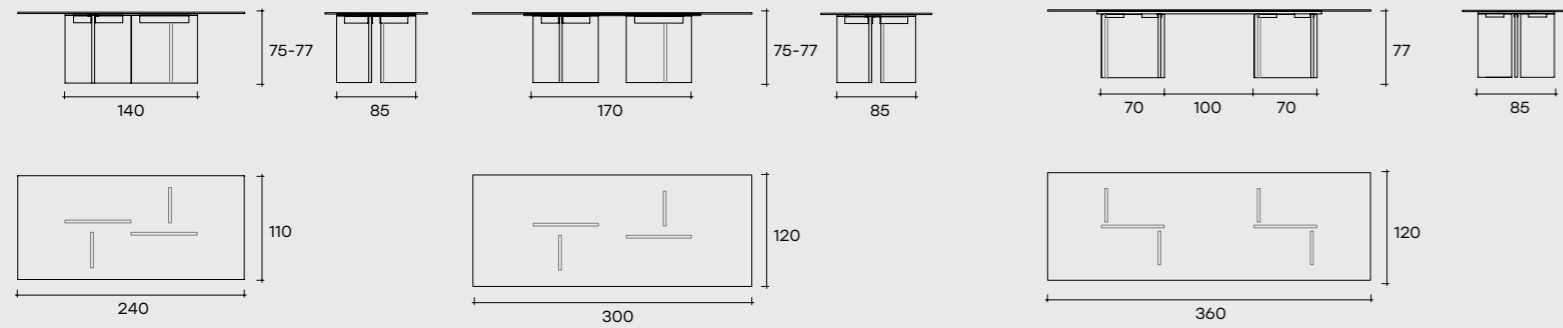

Base in DV-Glass  
DV-Glass base

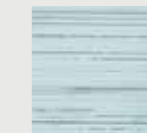

vetro fuso  
trasparente  
fused transparent  
glass

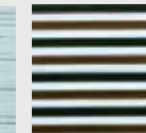

vetro fuso  
colorato  
fused colored  
glass

Base in DV-Glass e piano in legno  
DV-Glass base and wood top

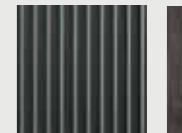

vetro fuso fumè  
e trasparente  
fused smoked and  
transparent glass



noce canaletto  
antracite opaco  
canaletto walnut  
matt anthracite

Piano in vetro verniciato  
Back-painted glass top

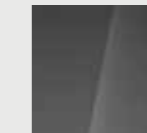

grigio grafite  
graphite grey

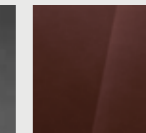

rosso vinaccia  
wine red

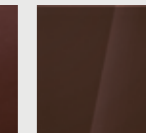

marrone  
testa di moro  
dark brown

Piano in vetro trasparente spatolato con Ecomalta  
Transparent glass top, Ecomalta finish

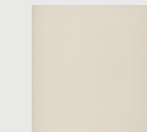

avorio  
ivory

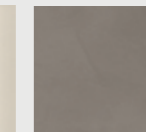

tortora  
dove-grey

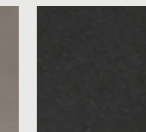

nero ardesia  
black slate

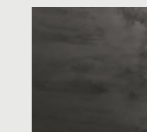

argilla  
clay brown

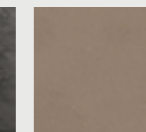

fango  
mud brown

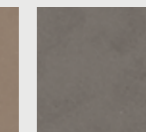

calce  
lime grey



# coral beach

DESIGN LUDOVICA  
+ ROBERTO PALOMBA



Table avec piètement en métal verni, finition Gris Lave opaque. Plateau en verre en fusion et trempé de 15mm, disponible transparent ou vernie dessous avec des teintes métallisées.

Tisch mit Gestell aus lackiertem Metall in der Ausführung "Lava Grey" matt. Platte aus 15 mm aus geschmolzenem und gehärtetem Glas, erhältlich transparent oder mit metallische Farben unterlackiert.

Tavolo con base in metallo verniciato, finitura Grigio Lava opaco. Piano in vetro da 15 mm fuso a gran fuoco e temperato, disponibile incolore o retroverniciato con tinte metallizzate.

Table with metal painted base, opaque "Lava Grey" finish. Top in 15 mm fused and tempered glass, available in Neutral finish or back-lacquered with metal shades.

220 x 106 x 75 cm  
86 5/8" x 41 3/4" x 29 1/2"  
240 x 106 x 75 cm  
94 1/2" x 41 3/4" x 29 1/2"  
260 x 120 x 75 cm  
102 3/8" x 47 1/4" x 29 1/2"

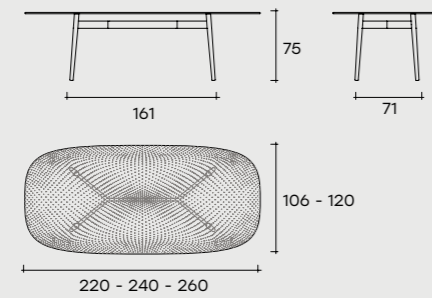

**Finitura top**  
Back-painted glass top



incolore  
rasparent

grigio lava  
lava grey

blu notte  
night blue



# corner

DESIGN  
CRS FIAM



Tavolo composto da basi in vetro curvato da 12 mm con lati da 45 cm e piano in vetro da 15 mm rettangolare, quadrato o rotondo.

Table with 12 mm-thick curved glass base (sides 45 cm) and 15 mm-thick glass top rectangular, square or round.

Table avec piètement en verre cintré de 12 mm, côtés de 45 cm. Top en verre de 15 mm rectangulaire, carré, rond.

Tisch mit 15 mm-starker Glasplatte. Untergestell aus 12 mm-starkem gebogenem Glas mit Winkeln von 45 cm. Glastisch mit rechteckiger, viereckiger oder runder Glasplatte.

rettangolare / rectangular  
rectangulaire / Rechteckig

170 x 80 x 73 cm  
66 5/16" x 31 1/2" x 28 3/4"  
180 x 90 x 73 cm  
70 7/8" x 35 7/16" x 28 3/4"  
220 x 110 x 73 cm  
86 5/8" x 43 5/16" x 28 3/4"

quadrato / square  
carré / Viereckig

110 x 110 x 73 cm  
43 5/16" x 43 5/16" x 28 3/4"  
120 x 120 x 73 cm  
47 1/4" x 47 1/4" x 28 3/4"  
140 x 140 x 73 cm  
55 1/8" x 55 1/8" x 28 3/4"

tondo / round  
rond / Runde

Ø 120 x 73 cm  
47 1/4" x 28 3/4"  
Ø 140 x 73 cm  
55 1/8" x 28 3/4"

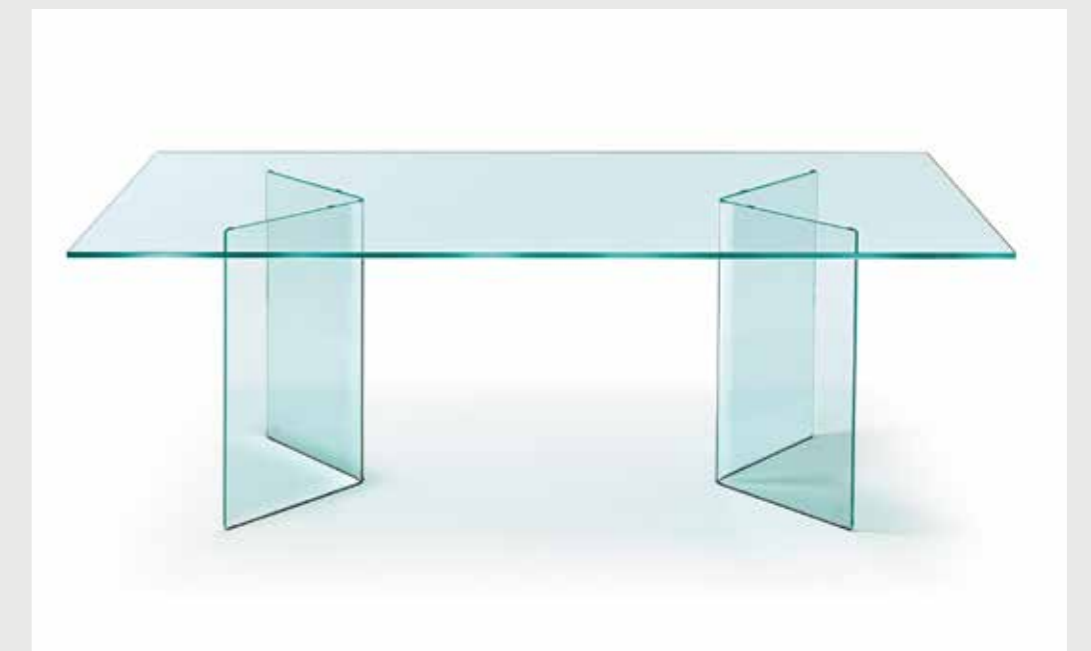
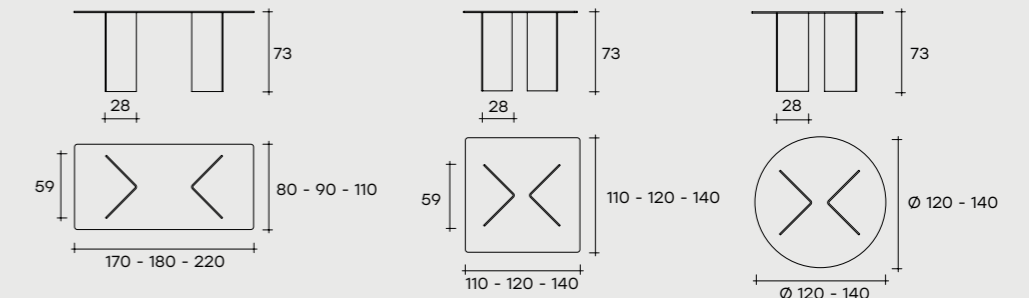

# epsylon

DESIGN  
FABIO DI BARTOLOMEI



Tavolo con piano in vetro trasparente, extralight, o bronzo da 10 mm temperato. Struttura in acciaio finitura cromato oppure ottone brunito effetto nuvolato. Piastre di fissaggio in acciaio inox o in ottone. Il tavolo Epsilon è disponibile anche con piani su misura, diametro da 90 a 140 cm.

Table with 10 mm-thick tempered transparent, extralight or bronze glass top. Chromed or burnished brass finish legs; stainless steel or brass fixing plates. The Epsilon table is also available with customized top, diameter from 90 cm to 140 cm.

Table avec plateau en verre trempé de 10 mm, transparent ou en verre extralight ou en verre bronze. Pieds en acier chromé ou finition laiton bruni de 10 mm, plaques de fixation en acier inoxydable ou en laiton. La table Epsilon est également disponible avec de plateau sur mesure, diamètre de 90 à 140 cm.

Tisch mit Platte aus 10 mm gehärtetem Glas in den folgenden Ausführungen erhältlich: transparentes Glas, extralight Glas oder Bronzeglas. Beine aus verchromtem oder getöntem Messing, Befestigungsplättchen aus Edelstahl oder aus Messing. Auch mit maßgefertigter Platte erhältlich, Durchmesser von 90 bis 140 cm.

Ø 120 x 75 cm  
Ø 47 1/4 x 29 1/2"  
Ø 140 x 75 cm  
Ø 55 1/8 x 29 1/2"

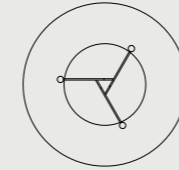
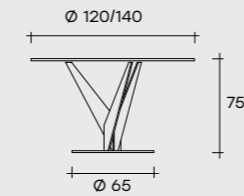



hype

DESIGN  
STUDIO KLASS

Tavolo fisso o allungabile con base in metallo verniciato, finitura "Grigio Lava". Piano in vetro da 12 mm o da 15 mm fuso e retroverniciato con tinte metallizzate, oppure in vetro trasparente o extralight retroverniciato con tinte monocromatiche o con tinta speciale effetto materico.

Fix or extendible table with metal painted base, "Lava Grey" finish. Top available in 12 or 15 mm high temperature melted glass, back-lacquered with metal shades, or transparent or extralight glass back-lacquered with monochrome shade or with a textured effect.

Table avec base en métal verni, finition « Gris Lave ». Plateau en verre en fusion de 12 ou 15 mm verni dessous avec teintes métallisées ou en verre transparent ou extralight verni dessous avec teintes monochromes ou avec une peinture spéciale effet matière.

Tisch mit Untergestell aus lackiertem Metall in der Farbe "Lavagrau". 12 mm oder 15 mm Glasplatte in den folgenden Ausführungen erhältlich: \_ geschmolzenes Glas mit metallisierten Farben unterlackiert \_ transparentes oder extralight Glas mit monochromatischen Farben oder mit einer Farbe aus materischem Effekt.

tavolo fisso / fix table  
table fixe / fester Tisch  
200 x 100 x 75 cm  
78 3/4" x 39 3/8" x 29 1/2"  
240 x 110 x 75 cm  
94 1/2" x 43 5/16" x 29 3/4"

tavolo allungabile  
extendible table  
table extensible  
ausziehbarer Tisch  
180 (280) x 90 x 75 cm  
70 7/8" (110 1/4") x 35 7/16" x 29 1/2"  
200 (300) x 100 x 75 cm  
78 3/4" (118 1/8") x 39 3/8" x 29 1/2"

Tavolo fisso  
Fix table

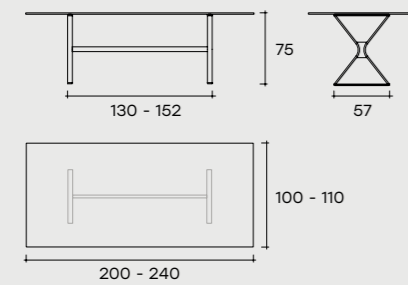

Tavolo allungabile  
Extendible table

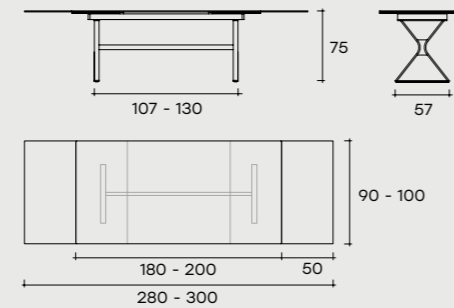

Piano in vetro  
Glass top

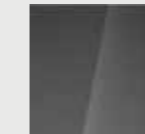

grigio grafite  
graphite grey

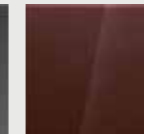

rosso vinaccia  
wine red

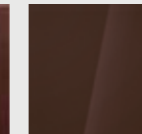

marrone testa di moro  
dark brown

Piano in vetro extralight acidato  
Etched extralight glass top

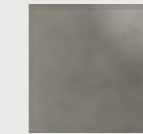

piombo satinato  
glazed lead

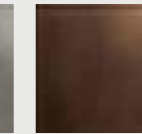

marrone nuvolato  
cloudy brown

Piano in vetro fuso  
Fused glass top

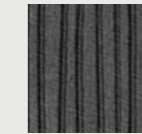

grigio lava  
lava grey

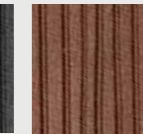

marrone ramato  
copper brown



kayo

DESIGN  
SATYENDRA PAKHALÉ

Tavolo allungabile con piano in vetro temperato da 15 mm, prolunghe indipendenti in vetro temperato da 12 mm profonde 52 cm. Gambe smontabili in vetro curvo da 19 mm e meccanismo in metallo finitura alluminio brill satinato o champagne satinato, con piastre in acciaio inox.

Extensible table with 15 mm top in tempered glass, independent extensions in 12 mm tempered glass, 52 cm long each. Detachable legs in 19 mm curved glass and mechanism in brushed metal, polished aluminium finish or champagne finish. Stainless steel plates.

Table à rallonges avec plateau en verre trempé de 15 mm, rallonges indépendantes en verre trempé de 12 mm, longueur 52 cm par côté. Pieds démontables en verre cintré de 19 mm et mécanisme en métal satiné finition aluminium brillant ou champagne avec plaques en acier inox.

Ausziehbarer Tisch mit Platte aus 15 mm starkem gehärtetem Glas, unabhängige Verlängerungen aus 12 mm starkem gehärtetem Glas, Länge 52 cm. Abnehmbare Beine aus gebogenem 19 mm starkem Glas und Mechanismus aus satiniertem Metall mit Aluminium Finish, hochglanzpoliert oder Champagne-Finish. Platten aus Edelstahl.

160 x 90 x 76 cm  
62" x 35 7/16" x 30"  
180 x 90 x 76 cm  
70 7/8" x 35 7/16" x 30"  
200 x 90 x 76 cm  
78 3/4" x 35 7/16" x 30"  
160 x 100 x 76 cm  
62" x 39 3/8" x 30"  
180 x 100 x 76 cm  
70 7/8" x 39 3/8" x 30"  
200 x 100 x 76 cm  
78 3/4" x 39 3/8" x 30"

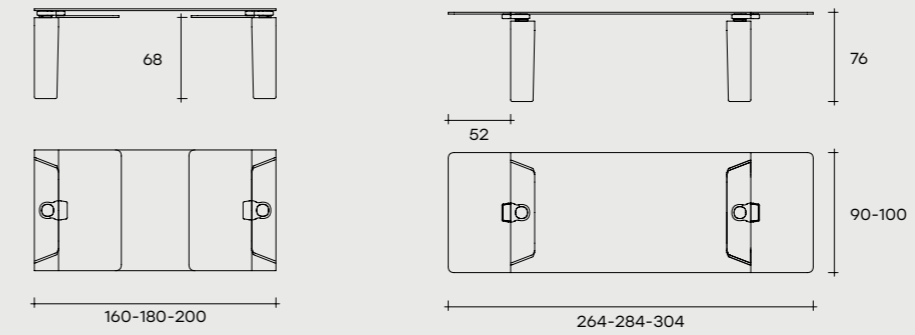

# kighi

DESIGN  
SETSU & SHINOBU ITO



Tavolo con base composta da 7 elementi in metallo verniciato, finitura Terra Bruciata o Grigio Platino. Piano in vetro da 15 mm temperato, disponibile nelle seguenti varianti: vetro trasparente retroverniciato con tinte metallizzate; vetro acidato retroverniciato con tinte metallizzate; vetro fuso retroverniciato con tinte metallizzate. Basamento in metallo finitura nero opaco.

Table with base made of seven lacquered metal elements, available in "Burned Earth" and "Platinum Grey" finishes. Top in 15 tempered glass, available in the following finishes: transparent back-painted glass with metal shades, etched back-painted glass with metal shade, fused back-painted glass with metal shades. Metal black finish metal base plate.

Table avec base composée de 7 éléments en métal verni, finition Terre Brûlée ou Gris Platine. Plateau en verre trempé de 15 mm, disponible dans les variantes suivantes : verre transparent verni dessous avec des teintes métallisées ; verre dépoli verni dessous avec des teintes métallisées ; verre en fusion verni dessous avec des teintes métallisées. Piètement de la base en métal verni noir mat.

Tisch mit Sockel aus sieben lackierten Metallelementen in „verbranntem Erdfarbe“ oder platingrau Ausführung. Platte aus 15 mm gehärtetem Glas, in den folgenden Varianten erhältlich: transparentes oder geätztes oder geschmolzenes Glas mit metallisierten Farben unterlackiert. Matt schwarz Metall Grundplatte.

200 x 100 x 75 cm  
78 3/4" x 39 3/8" x 29 1/2"

240 x 110 x 75 cm  
94 1/2" x 43 5/16" x 29 1/2"

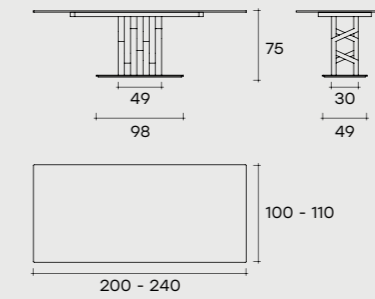

**Base in metallo**  
Metal base

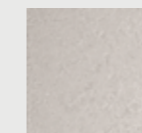

grigio platino  
platinum gray

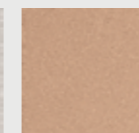

terra bruciata  
burned earth

**Piano in vetro**  
Glass top

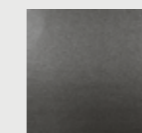

grigio lava  
lava gray

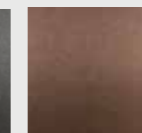

marrone  
metallizzato  
metallic brown

**Piano in vetro fuso**  
Fused glass top

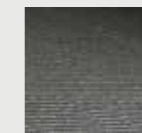

grigio lava  
lava gray

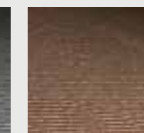

marrone  
metallizzato  
metallic brown

**Piano in vetro acidato**  
Acid-etched glass top

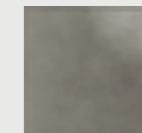

grigio titanio  
titanium gray

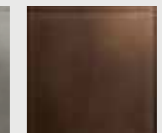

marrone  
metallizzato  
metallic brown

**LLT**DESIGN DANTE O. BENINI  
E LUCA GONZO

Tavolo con piano in vetro trasparente o extralight da 15 o 19 mm con bisellatura su due lati corti, struttura gambe in vetro trasparente o extralight saldato da 15 o 19 mm con bisellatura da 30 mm sul bordo. Particolari di fissaggio in acciaio inox. Il tavolo LLT prevede una base a due o tre gambe a seconda della lunghezza del piano; gli stessi sono disponibili anche a misura fino a 360x100 cm.

Table composed of a 15 or 19 mm thick transparent or extralight glass top with bevelled edges on the two shorter sides and of a base in 15 or 19 mm thick transparent or extralight welded glass with 30 mm bevelled edge. Fastening elements in stainless steel. The Table LLT can be fitted with two or three bases depending upon the top length. LLT table is also available with custom-sized top up to 360x100 cm.

Table se composant d'un plateau en verre transparent ou extralight de 15 ou 19 mm avec biseautage sur les deux côtés courts et d'un piétement en verre transparent ou extralight soudé, épaisseur 15 ou 19 mm, avec bords biseautés. Éléments de fixation en acier inoxydable. Le piétement se fait de deux, trois pieds dépendant de la longueur du plateau. Egalement disponible avec plateau sur mesure jusqu'à 360x100 cm.

Tisch mit Platte aus transparentem oder extralight 15 oder 19 mm starkem Glas, Facettenschliff auf den zwei kürzeren Seiten. Untergestell aus transparentem oder extralight 15 oder 19 mm starkem verschweisstem Glas, 30 mm Facettenschliff auf den Kanten. Verbindungselemente aus Edelstahl. Der Tisch kann mit zwei bzw. drei Beinen ausgerüstet werden, abhängig von der Plattelänge. Auch mit Maßgefertigter Platte erhältlich bis max. 360x100 cm.

spessore / thickness  
épaisseur / Stärke  
15 mm  
200 x 90 x 72 cm  
78 3/4" x 35 7/16" x 28 3/8"  
220 x 90 x 72 cm  
86 5/8" x 35 7/16" x 28 3/8"

spessore / thickness  
épaisseur / Stärke  
19 mm  
240 x 100 x 72 cm  
94 1/2" x 39 3/8" x 28 3/8"  
260 x 100 x 72 cm  
102 3/8" x 39 3/8" x 28 3/8"  
280 x 100 x 72 cm  
110 1/4" x 39 3/8" x 28 3/8"  
300 x 100 x 72 cm  
118 1/8" x 39 3/8" x 28 3/8"  
360 x 100 x 72 cm  
141 3/4" x 39 3/8" x 28 3/8"

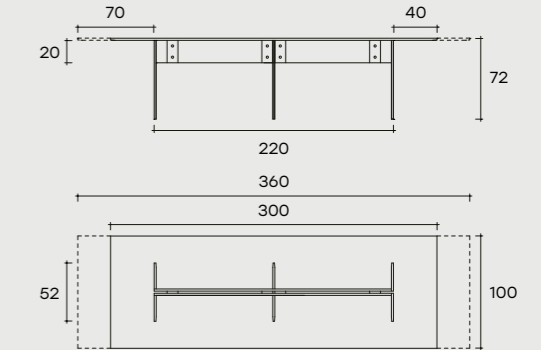
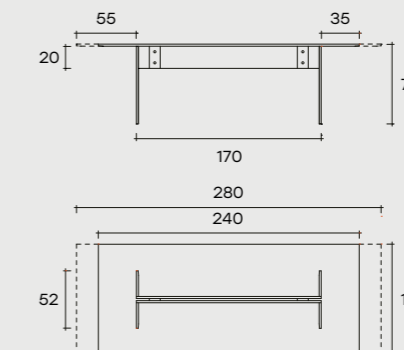
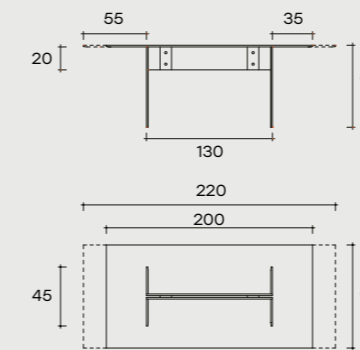

# LLT wood

DESIGN DANTE O. BENINI  
E LUCA GONZO



Tavolo con piano in legno multistrato marino da 40 mm impiallacciato noce canaletto, rovere "old" o rovere termotrattato. Struttura in vetro trasparente o extralight stratificato da 30 mm e gambe in vetro trasparente o extralight da 19 mm.

Table with top in 40 mm multilayered marine plywood veneered, canaletto walnut, "old style" oak finish or heat-treated oak finish. Structure in 30 mm laminated transparent or extralight glass and legs in 19 mm transparent or extralight glass.

Table avec plateau en bois multiplis marine, plaqué noyer noir, chêne vieilli ou chêne traité thermiquement. Structure en verre transparent ou extralight stratifié de 30 mm et pieds en verre transparent ou extralight de 19 mm.

Tisch mit 40 mm Mehrschichtplatte und Nussbaumfurnier, Eichenholz furnier hergestellt aus alten Eichebalken oder Eichenholz furnier wärmebehandelt. Struktur aus 30 mm transparentem oder extralight Schichtglas. Beine aus 19 mm transparentem oder extralight Glas.

200 x 100 x 74 cm  
78 3/4" x 39 3/8" x 29 1/8"  
240 x 100 x 74 cm  
94 1/2" x 39 3/8" x 29 1/8"  
300 x 110 x 74 cm  
118 1/8" x 43 5/16" x 29 1/8"

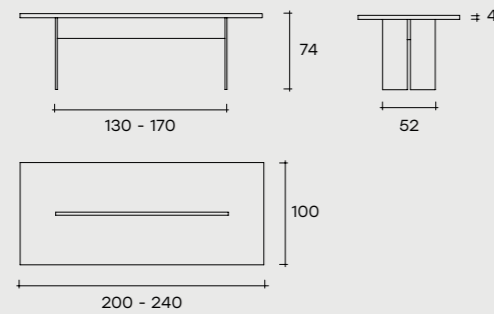

## Piano in legno Plywood top



noce canaletto  
canaletto walnut

rovere "old"  
"old style"  
oak finish

rovere  
termotrattato  
heat-treated  
oak finish

## Piano in legno spatolato con Ecomalta Ecomalta hand-finished wood top

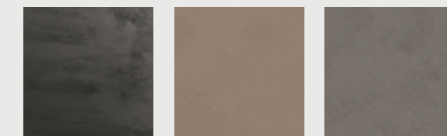

argilla  
clay brown

fango  
mud brown

calce  
lime grey

# luxor

DESIGN  
RODOLFO DORDONI



Tavolo con piano in vetro fumé o bronzo stratificato da 8+8 mm finitura filo lucido tondo, disponibile anche in vetro trasparente o extralight da 12 e da 15 mm. A seconda della misura e della configurazione desiderata base composta da 2, 3 o 4 cilindri (Ø 40 cm) in vetro da 10 mm, fumé, bronzo, NERO 95, trasparente o extralight, extralight retroverniciato bianco o retroargentato verniciato bianco. È possibile realizzare il piano su misura.

Table with a 8 mm+8 mm laminated smoked or bronze glass top, shiny polished edge, also available in transparent glass or extralight glass (12 or 15 mm thick). 10 mm-thick curved glass bases, composed of 2, 3 or 4 cylinders (Ø 40 cm) depending on the size and the shape requested. The glass bases available in the following finishings: transparent, extralight, extralight white back-stained or extralight back-silvered white stained, Black 95 (NERO 95), smoked or bronze. It is possible to order custom-sized tops.

Table avec plateau en verre feuilleté de 8+8 mm fumé ou bronze, finition bord poli arrondi, disponible aussi en verre transparent ou extralight de 12 ou 15 mm. Selon la mesure ou la configuration choisie, base composée par 2, 3 ou 4 cylindres (Ø 40 cm) en verre de 10 mm. fumé, bronze, Noir 95 (NERO 95), transparent ou extralight, extralight verni dessous blanc, extralight argenté verni dessous blanc. Plateau disponible aussi en version sur mesure.

Tisch mit 8+8 mm-starker Schichtglasplatte in Rauch- oder Bronze-Glas oder in transparentem bzw. extralight Glas, 12 oder 15 mm Stärke. Untergestell bestehend aus 2, 3 bzw. 4 Glas-Zylindern (Durchmesser 40 cm) abhängig von den gewünschten Massen und Gestaltung, 10 mm. Glasstärke. Lieferbar in den folgenden Ausführungen: Rauch- oder Bronzeglas, Schwarz 95 (NERO 95)-Glas, transparentes bzw. extralight-Glas, weiss lackiertes extralight-Glas oder extralight-Glas versilbert mit Weiß Lackierung. Die Tischplatte kann nach Maß bestellt werden.

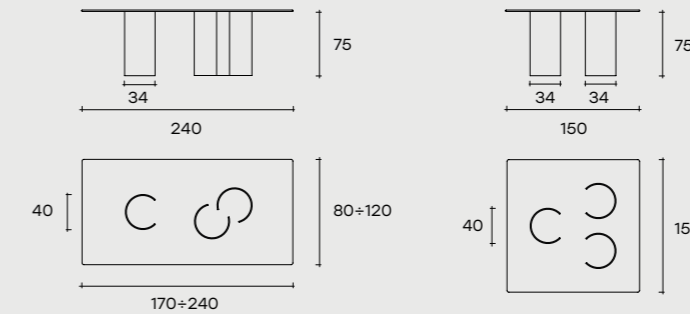

220 x 110 x 75 cm  
86 5/8" x 43 5/16" x 29 1/2"

240 x 120 x 75 cm  
94 1/2" x 47 1/4" x 29 1/2"

150 x 150 x 75 cm  
59 1/16" x 59 1/16" x 29 1/2"



# magma

DESIGN  
PATRICK JOUIN



Tavolo con piano in vetro da 15mm fuso a gran fuoco e temperato, disponibile nelle tinte trasparenti Fumo, Blu o Ambra. Struttura in legno rovere massello disponibile nelle finiture naturale o tinto grigio.

Table with 15 mm fused and tempered glass top, available in Smoke grey, Blue or Amber finish. Oak solid wood structure available in natural or grey finish.

Table avec plateau en verre en fusion de 15 mm trempé, disponible dans les teintes transparentes Fumée, Bleu ou Ambre. Structure en bois massif de chêne disponible dans les finitions naturelle ou de couleur grise.

Tisch mit Platte aus 15 mm geschmolzenem und gehärtetem Glas in den folgenden Ausführungen erhältlich: Rauch, Blau oder Bernstein. Untergestell aus massivem Eichenholz in den folgenden Ausführungen erhältlich: Natur oder Grau-gefärbt.

tondo / round  
Ø 160 P 75  
Ø 62" D 29 1/2"

quadrato / square  
L 140 P 140 H 75 cm  
W 55 1/8" D 55 1/8" H 29 1/2"  
L 160 P 160 H 75 cm  
W 62" D 62" H 29 1/2"

rettangolare / rectangular  
L 220 P 106 H 75 cm  
W 86 5/8" D 41 3/4" H 29 1/2"  
L 240 P 106 H 75 cm  
W 94 1/2" D 41 3/4" H 29 1/2"  
L 260 P 110 H 75 cm  
W 102 3/8" D 43 5/16" H 29 1/2"

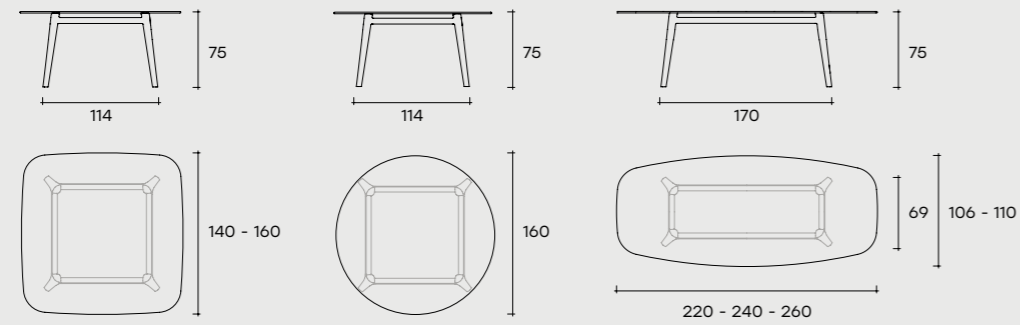

#### Struttura Structure

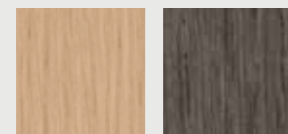

legno rovere  
naturale  
natural oak

legno rovere  
tinto grigio  
grey finish oak

#### Piano in vetro Glass top



fumo  
smoke grey

blu  
blue

ambra  
amber

naturale effetto satinato  
natural satin finish

plié

DESIGN  
STUDIO KLASS

Tavolo composto da due basi in vetro sagomato e curvato da 12 mm, disponibili in vetro fumè o extralight; piano disponibile in vetro extralight, oppure in legno impiallacciato finitura rovere termotrattato, oppure in legno spatolato a mano con Ecomalta ad effetto materico, colore Argilla. Spatolatura tipo materica.

Table consisting of two 12 mm shaped and curved glass bases, available in smoked or extralight glass; top available in extralight glass, or in veneered wood with heat-treated oak, or in wood hand-finished with Ecomalta, rough texture finish, clay colour.

Table composée de deux bases en verre, façonné et cintré de 12 mm disponible en verre fumé ou extra light; plateau disponible en verre extra light ou en bois plaqué finition chêne thermotraité ou en bois enduit à la main avec Ecomalta effet matière couleur Argile. Finition texture irrégulière.

Tisch bestehend aus 2 geformten und gebogenen Basiselementen aus Rauchglas oder aus Extra Light Glas, Stärke 12 mm. Tischplatte aus Extra Light Glas oder aus furniertem Holz, wärmebehandelte Eiche, oder mit Ecomalta handgespachteltem Effekt auf Holz, Lehmfarbe, textilhähnliche Bearbeitung, unregelmäßig.

Tavolo con piano in legno. Wood top table.

200 x 100 x 75 cm  
78 3/4" x 39 3/8" x 29 1/2"

240 x 100 x 75 cm  
94 1/2" x 39 3/8" x 29 1/2"

Tavolo con piano in vetro. Glass top table.

200 x 100 x 75 cm  
78 3/4" x 39 3/8" x 29 1/2"

240 x 110 x 75 cm  
94 1/2" x 43 5/16" x 29 1/2"

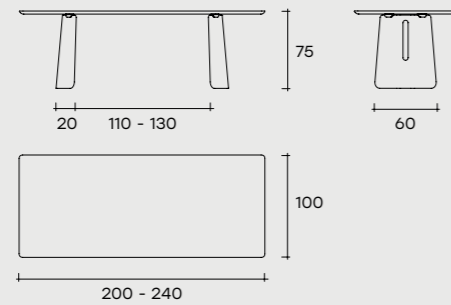

Piano in legno  
Wood top



legno rovere  
termotrattato  
heat-treated  
dark finish

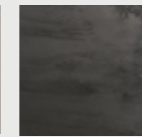

argilla  
clay brown

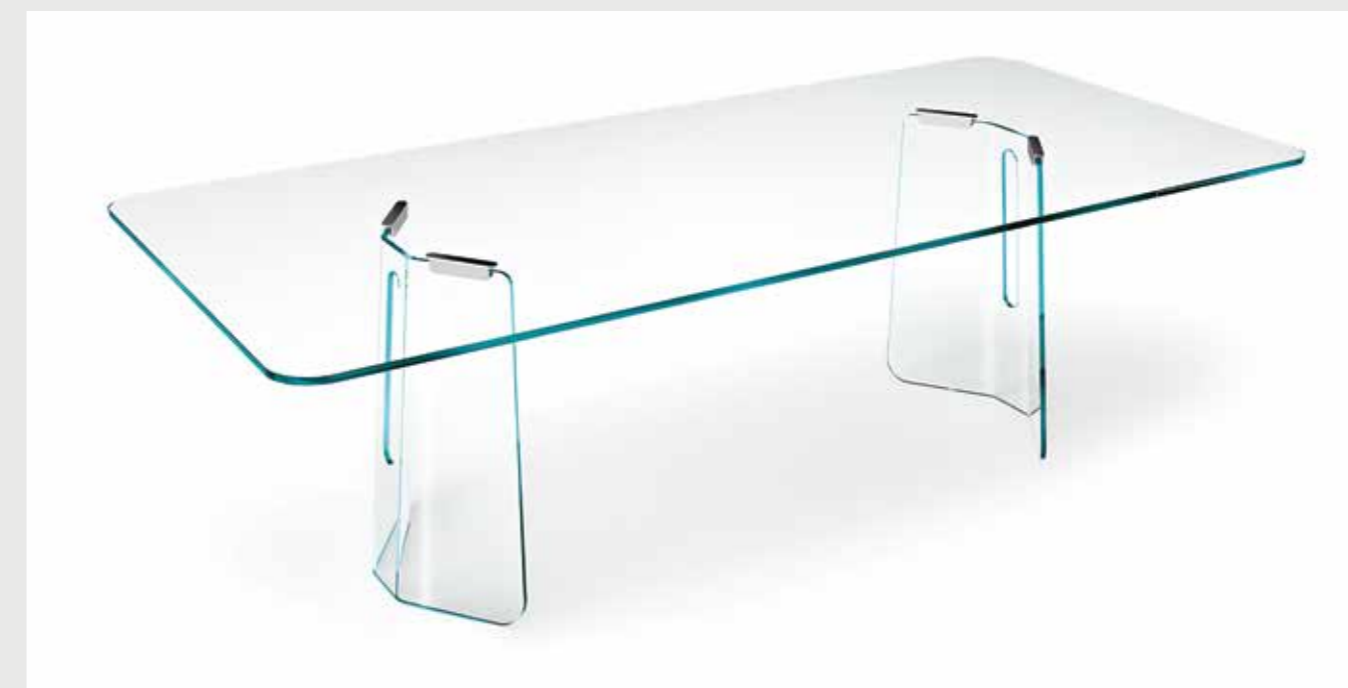
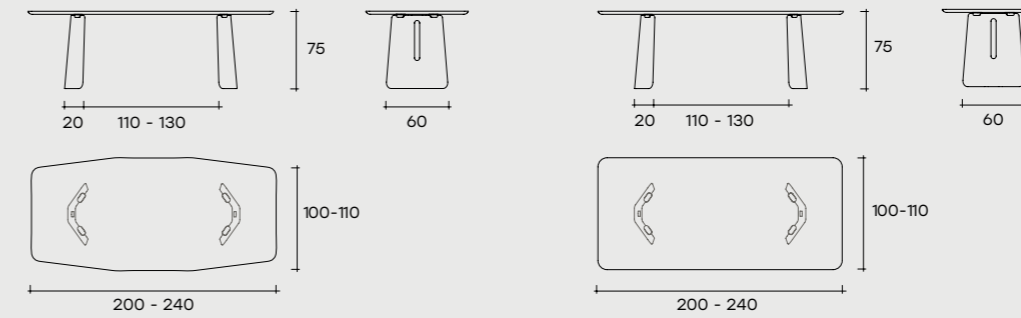

ray

DESIGN  
BARTOLI DESIGN

Tavolo composto da piano in vetro da 15 mm e gambe smontabili in vetro curvato da 20 mm. Giunzioni in alluminio finitura brill. Nella versione rettangolare il piano è realizzabile al centimetro fino ad una lunghezza di cm 280. Disponibile anche in vetro extralight.

Dining table with 15 mm-thick glass top and detachable legs in 20 mm-thick curved glass. Joints in aluminium with gloss finishing. The rectangular shaped top version can be custom ordered up to a maximum length of 280 cm. Also available in extralight glass.

Table avec plateau en verre de 15 mm et pieds démontables en verre cintré de 20 mm. Jonctions en aluminium finition brillante. Dans la version rectangulaire le plateau peut être réalisé au centimètre jusqu'à une longueur de cm 280. Disponible aussi en verre extralight.

Tisch mit 15 mm-starker Glasplatte und abnehmbaren Tischbeinen aus 20 mm-starkem gebogenem Glas. Die Verbindungen sind in Aluminium mit Finisch hochglanz. Zentimetergenaue Maßanfertigung (Länge max. 280 cm) für die rechteckige Version. Lieferbar auch aus extralight-Glas.

170 ÷ 280 x 90 x 75 cm  
66 15/16" ÷ 110 1/4" x 35 7/16" x 29 1/2"  
170 ÷ 280 x 100 x 75 cm  
66 15/16" ÷ 110 1/4" x 39 3/8" x 29 1/2"  
120 x 120 x 75 cm  
47 1/4" x 47 1/4" x 29 1/2"  
130 x 130 x 75 cm  
51 3/16" x 51 3/16" x 29 1/2"  
140 x 140 x 75 cm  
55 1/8" x 55 1/8" x 29 1/2"  
150 x 150 x 75 cm  
59 1/16" x 59 1/16" x 29 1/2"

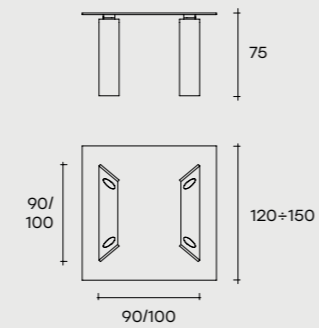
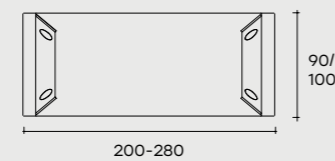
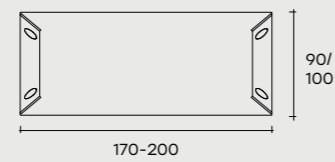

ray plus

DESIGN  
BARTOLI DESIGN

Tavolo allungabile con piano in vetro temperato da 15 mm, rettangolare, prolunghie indipendenti in vetro temperato da 12 mm lunghe 52 o 41 \* cm. Gambe smontabili in vetro curvato da 20 mm montate a filo del piano. Braccio ruotante in alluminio finitura brill con piastre in acciaio inox. Disponibile anche in vetro extralight.

Extensile dining table with rectangular 15 mm-thick tempered glass top and independent extensions in 12 mm-thick tempered glass. Detachable legs in 20 mm-thick curved glass, placed just under the top edge. Rotating mechanism in aluminium, gloss finishing and stainless steel plates. Also available in extralight glass.

Table à rallonges avec plateau en verre trempé de 15 mm rectangulaire et rallonges indépendantes en verre trempé de 12 mm, longueur 52 ou 41 \* cm par côté. Pieds démontables en verre cintré de 20 mm positionnés au bord du plateau. Bras en aluminium finition brillante et plaques en acier inox. Disponible aussi en verre extralight.

Ausziehbarer Tisch mit rechteckiger 15 mm-starker gehärteter Glasplatte und unabhängigen Verlängerungen aus 12 mm-starkem gehärtetem Glas, Länge 52 oder 41 \* cm pro Seite. Abnehmbare Tischbeine aus 20 mm - starkem gebogenem Glas, bündig an der Plattenkante montiert. Drehbarer Mechanismus aus Aluminium, Finisch hochglanz und Platten aus rostfreiem Stahl. Der Tisch ist auch aus extralight-Glas lieferbar.

140 (222) x 90 x 75 cm \*  
55 1/8" (87 3/8") x 35 7/16" x 29 1/2" \*  
160 (264) x 90 x 75 cm  
63" (103 15/16") x 35 7/16" x 29 1/2"  
160 (264) x 100 x 75 cm  
63" (103 15/16") x 39 3/8" x 29 1/2"  
180 (284) x 90 x 75 cm  
70 7/8" (111 3/4") x 35 7/16" x 29 1/2"

180 (284) x 100 x 75 cm  
70 7/8" (111 3/4") x 39 3/8" x 29 1/2"  
200 (304) x 90 x 75 cm  
78 3/4" (119 1/16") x 35 7/16" x 29 1/2"  
200 (304) x 100 x 75 cm  
78 3/4" (119 1/16") x 39 3/8" x 29 1/2"

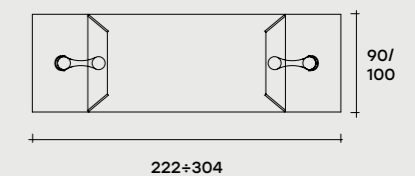
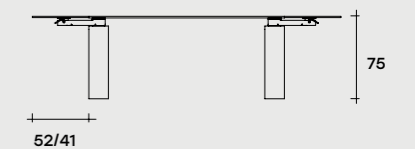
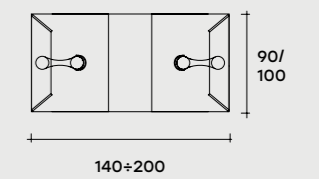
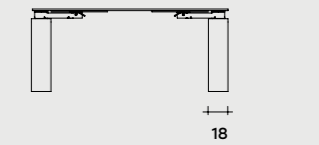



rime

DESIGN  
BARTOLI DESIGN

Tavolo fisso o allungabile con piano in vetro temperato da 12 o 15 mm. Disponibile in diverse finiture: vetro acidato o liscio, retroverniciato; vetro trasparente ricoperto in Ecomalta, spatolatura tipo fine. Basamento composto da elementi in vetro extralight da 15 mm fuso a gran fuoco.

Fix or extendible table with 12 mm or 15 mm tempered glass top. Following finishes available: back-painted glass or back painted acid etched glass or glass hand finished with Ecomalta, finer-grained texture finish. 15 mm extralight fused glass base.

Table fixe ou à rallonges avec plateau en verre trempé de 12 mm ou 15 mm. Différentes finitions disponibles : verre laqué au dos ou verre dépoli laqué au dos ou verre enduit à la main avec Ecomalta effet matière. Finition Texture au grain fin. Base composée d'éléments en verre extra light en fusion de 15 mm.

Tisch oder ausziehbarer Tisch mit gehärteter Glasplatte, Stärke 12 mm oder 15 mm. Platte in den folgenden Ausführungen erhältlich: lackiertes Glas oder geätztes lackiertes Glas oder mit Ecomalta handgespachteltem Effekt auf Glas. Feine Textilähnliche Bearbeitung. Untergestell aus 15 mm geschmolzenem extra light Glas.

130 (230) x 130 x 75 cm  
51 3/16" (90 9/16") x 51 3/16" x 29 1/2"  
146 (236) x 146 x 75 cm  
57 1/2" (93") x 57 1/2" x 29 1/2"

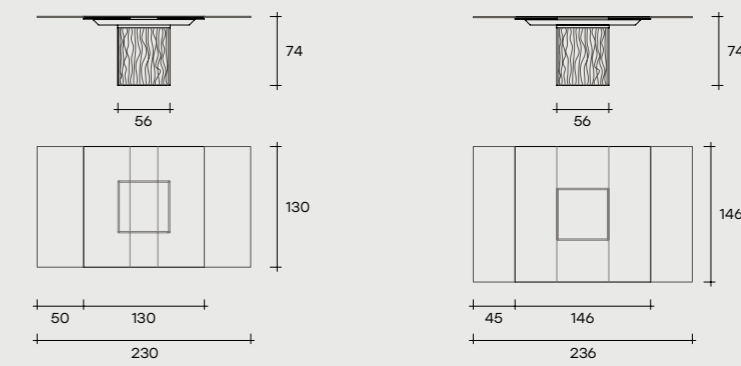

Piano in vetro trasparente spatolato con Ecomalta  
Transparent glass top, Ecomalta finish

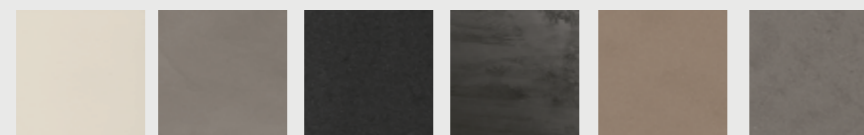

avorio  
ivory

tortora  
dove-grey

nero ardesia  
black slate

argilla  
clay brown

fango  
mud brown

calce  
lime grey

Piano in vetro  
Glass top

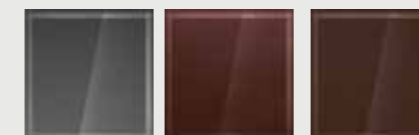

grigio grafite  
graphite grey

rosso vinaccia  
wine red

marrone  
testa di moro  
dark brown

Piano in vetro acidato  
Acid-etched glass top

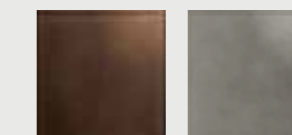

marrone  
metallizzato  
metallic brown

grigio titanio  
titanium grey

# ragno

DESIGN  
VITTORIO LIVI

Tavolo monolitico in vetro  
curvato da 15 mm  
trasparente  
o in vetro extralight.

Monolithic dining table  
in transparent or extralight  
15 mm-thick curved glass.

Table d'une seule dalle  
de verre cintré de 15 mm  
transparent ou extralight.

Tisch aus 15 mm-starkem  
transparentem oder  
extralight gebogenem  
Glas, aus einer einzigen  
Glasplatte gefertigt.

188 x 98 x 75 cm  
74" x 38 9/16" x 29 1/2"  
228 x 108 x 75 cm  
89 3/4" x 42" x 29 1/2"

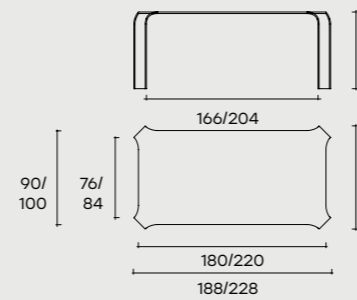

# sahara

DESIGN  
BARTOLI DESIGN



Tavolo composto  
da basi in vetro  
trasparente o vetro  
extralight curvato  
da 10 mm e piano in vetro  
trasparente o vetro  
extralight da 15 mm.  
Il tavolo Sahara  
è disponibile anche  
con piani a misura.

Table consisting  
of 10 mm curved  
transparent or extralight  
glass bases and  
15 mm transparent  
or extralight glass top.  
The Sahara table is  
also available with tops  
of customized size.

Table composée  
de bases en verre  
transparent ou en verre  
extralight cintré de 10 mm  
et d'un plateau en verre  
transparent ou en verre  
extralight de 15 mm.  
La table Sahara  
est également disponible  
avec plateau sur mesure.

Tisch mit Untergestell  
aus gebogenem  
transparentem Glas  
oder Extralight-Glas  
Stärke 10 mm, und 15 mm  
starker Platte aus  
transparentem oder  
Extralight-Glas.  
Auch mit maßgefertigter  
Platte lieferbar.

rotondo / round  
rond / Rund  
Ø130 x 75 cm  
Ø51 3/16" x 29 1/2"  
Ø140 x 75 cm  
Ø55 1/8" x 29 1/2"

quadrato / square  
carré / Viereckig  
130 x 130 x 75 cm  
51 3/16" x 51 3/16" x 29 1/2"  
140 x 140 x 75 cm  
55 1/8" x 55 1/8" x 29 1/2"

rettangolare / rectangular  
rectangulaire / Rechteckig  
190 x 90 x 75 cm  
74 3/4" x 35 7/16" x 29 1/2"  
210 x 100 x 75 cm  
82 1/16" x 39 3/8" x 29 1/2"

ellittico / elliptic  
elliptique / Elliptisch  
210 x 135 x 75 cm  
82 1/16" x 54" x 29 1/2"  
sagomato / shaped top  
façonné  
Mit abgerundeten Seiten  
200 x 100 x 75 cm  
78 3/4" x 39 3/8" x 29 1/2"

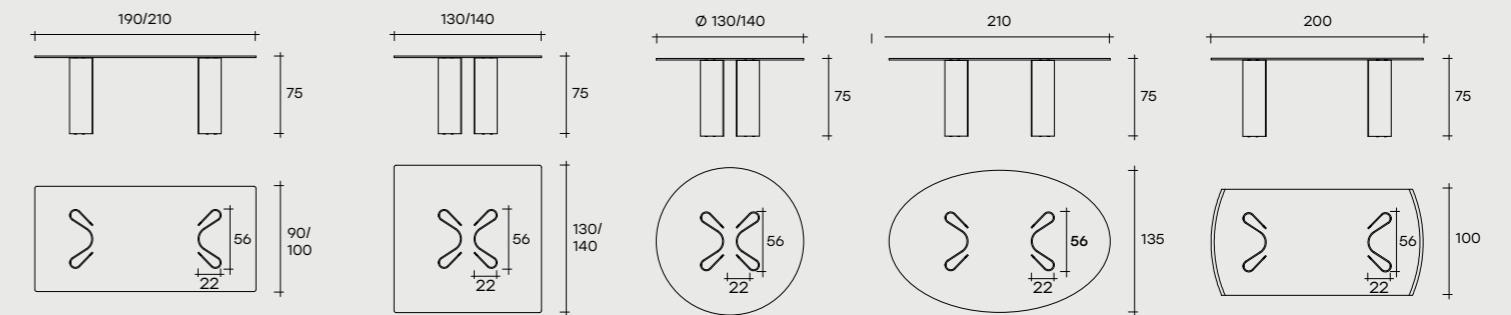

theo

DESIGN  
SIMONE BONANNI

Tavolo fisso o allungabile con base composta da telaio in metallo verniciato, finitura nero opaco, sul quale sono applicati due vetri da 6 mm fusi ad alta temperatura e temperati, disponibili con texture a righe o con texture goffrata. Piano in vetro da 12 o 15 mm temperato, disponibile nelle seguenti varianti: vetro retroverniciato con tinte monocromatiche; vetro acidato retroverniciato con tinte metallizzate; vetro ricoperto in Ecomalta, spatolatura tipo fine.

Fixed or extendible table with metal painted base, opaque black finish, where two 6 mm thick fused and tempered glasses are placed, available with striped texture or with embossed texture. Top in 12 or 15 mm tempered glass available in: back-lacquered glass with monochrome shade; acid-etched and back-lacquered glass with metal shades; glass hand-finished with Ecomalta, finer-grained texture finish.

Table fixe ou à rallonges avec piètement composé d'un cadre en métal verni, finition noir opaque, sur lequel sont appliquées deux plaques de verre en fusion et trempé de 6 mm, disponibles avec texture à rayures ou gaufrée. Plateau en verre trempé de 12 ou 15 mm disponible dans les variantes suivantes : verre transparent verni dessous avec des teintes monochromes; verre transparent dépoli verni dessous avec des teintes métallisées; verre transparent enduit finement à la main avec Ecomalta.

Tisch oder ausziehbarer Tisch mit lackiertem Metallgestell in dem 2 geschmolzene, gehärtete Gläser (6 mm) eingesetzt sind, mit Streifen -Dekor oder mit gaufriertem Dekor. Platte aus 12 oder 15 mm gehärtetem Glas, in den folgenden Ausführungen: transparentes Glas mit monochromatischen Farben unterlackiert, transparentes geätztes Glas mit Metallfarben unterlackiert oder mit Ecomalta handgespachteltem Effekt auf Glas, feine Textilähnliche Bearbeitung.

tavolo fisso / fix table  
table fixe / fester Tisch  
130 x 130 x 75 cm  
51 3/16" x 51 3/16" x 29 1/2"  
146 x 146 x 75 cm  
57 1/2" x 57 1/2" x 29 1/2"  
200 x 100 x 75 cm  
78 3/4" x 39 3/8" x 29 1/2"  
240 x 110 x 75 cm  
94 1/2" x 43 5/16" x 29 1/2"

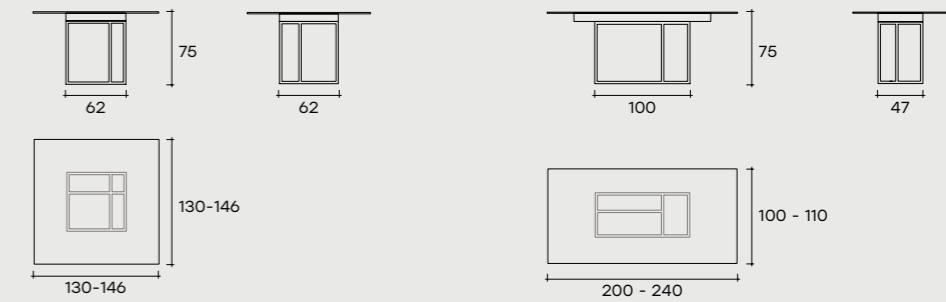

tavolo allungabile  
extendible table  
table extensible  
ausziehbarer Tisch  
130 (230) x 130 x 75 cm  
51 3/16" (90 9/16") x 51 3/16" x 29 1/2"  
146 (236) x 146 x 75 cm  
57 1/2" (93") x 57 1/2" x 29 1/2"  
180 (280) x 100 x 75 cm  
70 7/8" (110 1/4") x 39 3/8" x 29 1/2"  
200 (300) x 100 x 75 cm  
78 3/4" (118 1/8") x 39 3/8" x 29 1/2"

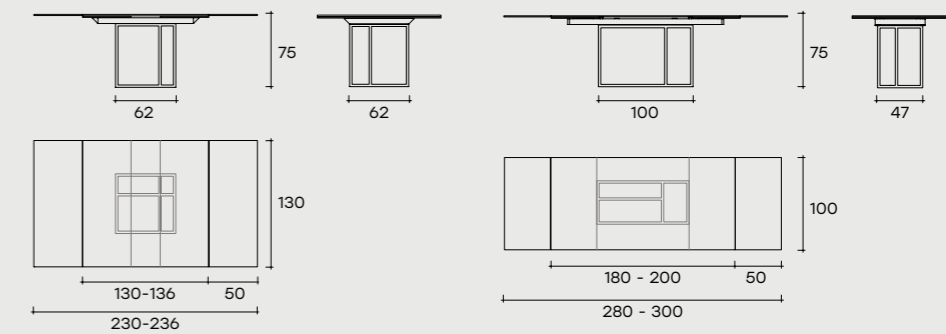

**Piano in vetro trasparente spatolato con Ecomalta**  
Transparent glass top, Ecomalta finish

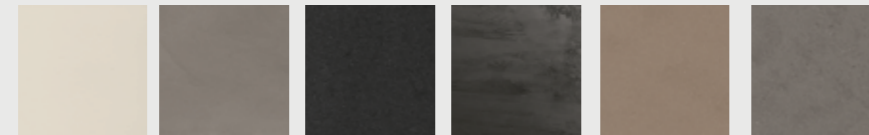

avorio  
ivory

tortora  
dove-grey

nero ardesia  
black slate

argilla  
clay brown

fango  
mud brown

calce  
lime grey

**Piano in vetro**  
Glass top

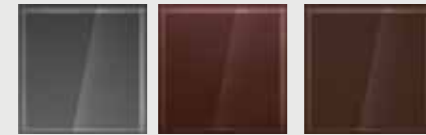

grigio grafite  
graphite grey

rosso vinaccia  
wine red

marrone  
testa di moro  
dark brown

**Piano in vetro acidato**  
Acid-etched glass top

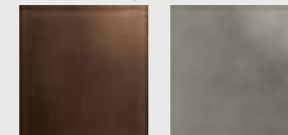

marrone  
metallizzato  
metallic brown

grigio titanio  
titanium grey

**Base in vetro fuso a righe**  
Striped fused glass base

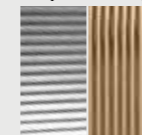

fumè + bronzo  
smoked + bronze

**Base in vetro fuso goffrato**  
Embossed fused glass base

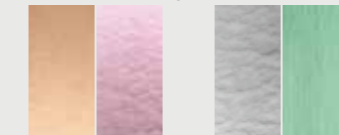

ambra + rosa antico  
amber + antique pink

fumo + verde alga  
smoke + seaweed green



# waves

DESIGN LUDOVICA  
+ ROBERTO PALOMBA



Tavolo fisso o allungabile  
con base composta da  
due elementi in DV Glass  
da 30 mm trasparente  
o a strisce colorate.

Piano in vetro da 12 mm  
o da 15 mm trasparente  
retroverniciato con tinte  
monocromatiche, oppure  
ricoperto in Ecomalta  
spatolatura tipo fine.

Fix or extendible table  
with base made of two  
separate 30 mm DV Glass  
elements, transparent  
or with colored stripes.

Top available in 12 or 15 mm  
transparent glass,  
back-lacquered with  
monochrome finishes, or  
hand-finished with Ecomalta,  
finer-grained texture finish.

Table fixe ou à rallonges  
avec base composée par  
deux éléments en DV Glass  
de 30 mm, transparent  
ou avec bandes colorées.

Plateau en verre de 12  
ou 15 mm transparent  
verni dessous avec  
teintes monochromes,  
ou enduit finement  
à la main avec Ecomalta.

Tisch oder ausziehbarer  
Tisch mit Untergestell  
bestehend aus zwei  
Elementen aus DV Glass,  
Stärke 30 mm, in der  
Ausführung transparent  
oder mit farbigen Streifen.

12 mm oder 15 mm Glasplatte  
in den folgenden Varianten:  
mit monochromatischen  
Farben unterlackiert  
oder mit Ecomalta  
handgespachteltem  
Effekt auf Glas, feine  
Textilähnliche Bearbeitung.

tavolo fisso / fix table  
table fixe / fester Tisch

200 x 100 x 75 cm  
78 3/4" x 39 3/8" x 29 1/2"

240 x 110 x 75 cm  
94 1/2" x 43 5/16" x 29 1/2"

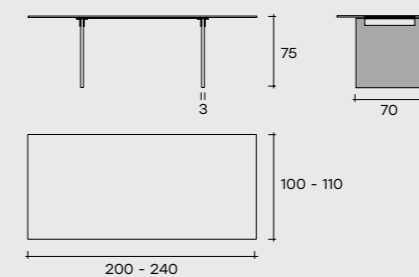

tavolo allungabile  
extendible table  
table extensible  
ausziehbarer Tisch

180 (280) x 100 x 75 cm  
70 7/8" (110 1/4") x 39 3/8" x 29 1/2"

200 (300) x 100 x 75 cm  
78 3/4" (118 1/8") x 39 3/8" x 29 1/2"

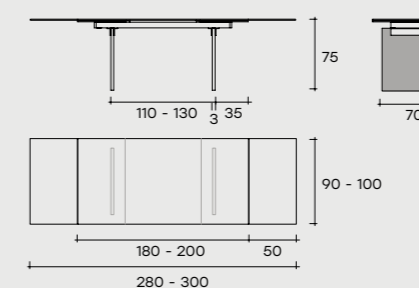

**Piano in vetro trasparente spatolato con Ecomalta**  
Transparent glass top, Ecomalta finish

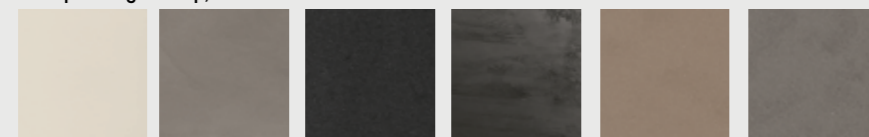

avorio  
ivory

tortora  
dove-grey

nero ardesia  
black slate

argilla  
clay brown

fango  
mud brown

calce  
lime grey

**Piano in vetro**  
Glass top

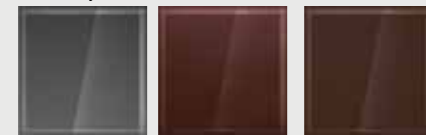

grigio grafite  
graphite grey

rosso vinaccia  
wine red

marrone  
testa di moro  
dark brown

**Base in DV-Glass**  
DV-Glass base



vetro fuso  
trasparente  
fused transparent  
glass

vetro fuso colorato  
fused colored glass



# atlas

DESIGN  
DANNY LANE



Tavolo basso in vetro  
curvato da 19 mm.  
Gambe composte  
da 19 sezioni di vetro  
sculpto a mano da 19 mm  
ed incollate l'una sull'altra.

Coffee table  
in 19 mm-thick curved  
glass with hand  
sculptured legs,  
composed of 19 single  
19 mm-thick glass  
elements glued together.

Table basse en verre  
cintré de 19 mm.  
Pieds composés  
de 19 sections en verre  
de 19 mm sculptées  
à la main et encollées.

Couchtisch aus  
19 mm-starkem  
gebogenem Glas.  
Handbehauene Tischbeine  
aus 19 mm-starkem Glas.

148 x 70 x 40 cm  
58 1/4" x 27 9/16" x 15 3/4"

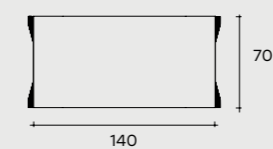
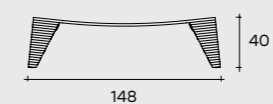

# cannage

DESIGN  
EMMANUEL GALLINA

Tavolino con piano in vetro da 10 mm temperato e fuso a gran fuoco con trama "Cannage", disponibile trasparente oppure retroverniciato con tinte semi-trasparenti Fumo o Ambra. Struttura in legno massello, finitura rovere tabacco a poro aperto.

Coffee table with 10 mm tempered and fused glass top with "Cannage" texture, available transparent or in Smoke Grey or Amber back-painted semi-transparent finishes. Solid wood structure in tobacco oak, open-pore finish.

Table basse avec plateau en verre en fusion et trempé de 10mm avec trame « Cannage », disponible transparent ou vernie dessous avec des teintes semi-transparentes Fumé ou Ambre. Structure en bois massif, finition chêne de tabac à pore ouvert.

Couchtisch aus geschmolzenem und gehärtetem 10 mm Glas mit "Cannage" Dekor in den folgenden Ausführungen erhältlich: transparent oder semi-transparent rauch oder bernstein unterlackiert. Untergestell aus massivem Holz in der Ausführung Eiche-Tabak offenporig.

Ø 120 x 40 cm  
Ø 47 1/4" x 15 3/4"  
Ø 90 x 40 cm  
Ø 35 7/16" x 15 3/4"  
Ø 65 x 45 cm  
Ø 25 9/16" x 17 11/16"  
Ø 50 x 55 cm  
Ø 19 11/16" x 21 5/8"

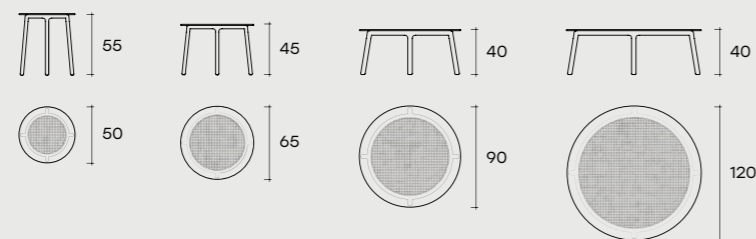

Piano in vetro fuso  
Fused glass top

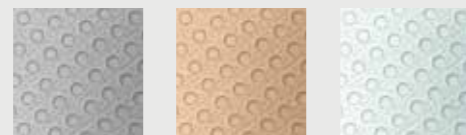

fumo  
smoke grey

ambra  
amber

trasparente  
transparent

# charlotte

DESIGN  
PROSPERO RASULO



Tavolo basso in vetro curvato da 10\* o 12 mm. Disponibile anche in vetro extralight. Ripiano opzionale in vetro curvato da 6 mm acidato.

Coffee table in 10\* or 12 mm-thick curved glass. Also available in extralight glass. Optional shelf in 6 mm-thick acid-etched curved glass.

Table basse en verre cintré de 10\* ou 12 mm. Disponible aussi en verre extralight. Étagère en verre cintré dépoli de 6 mm. sur demande.

Couchtisch aus 10\* oder 12 mm-starkem gebogenem Glas. Lieferbar auch aus extralight-Glas. Auf Wunsch: Fachboden aus 6 mm-starkem gebogenem und geätzttem Glas.

100 x 60 x 40 cm\*  
39 3/8" x 23 5/8" x 15 3/4"  
120 x 60 x 40 cm  
47 1/4" x 23 5/8" x 15 3/4"  
130 x 68 x 40 cm  
51 3/16" x 26 3/4" x 15 3/4"

ripiano / shelf  
étagère / Fachboden  
82,5 x 59 x 2,5 cm  
32 1/2" x 23" x 1"  
102,5 x 59 x 3,5 cm  
40 3/8" x 23" x 1 3/8"  
112,5 x 67 x 4 cm  
44 5/16" x 26 3/8" x 1 9/16"

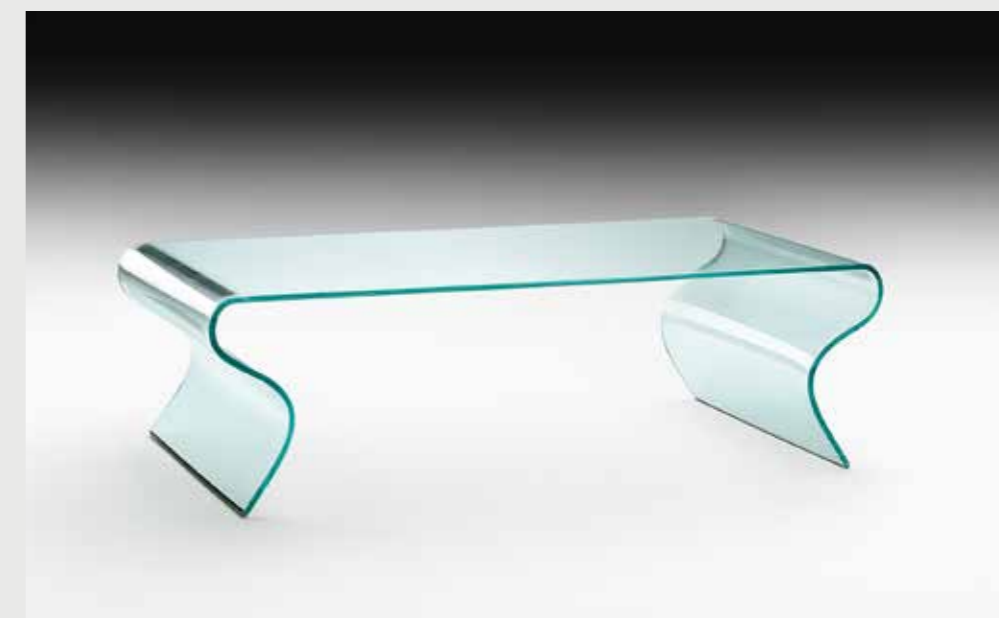
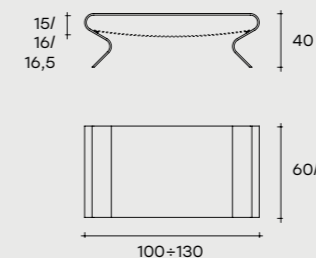

hype

DESIGN  
STUDIO KLASS

Tavolino con piano in vetro da 12 mm fuso a gran fuoco, temperato e retroverniciato con tinte metallizzate Grigio Lava, Marrone Ramato o Champagne. Base in metallo verniciato, finitura Grigio Lava.

Coffee table with 12 mm fused, tempered and back-lacquered glass top with metal shades Lava Grey, Copper Brown or Champagne. Metal painted base, "Lava Grey" finish.

Table basse avec plateau en verre en fusion de 12 mm, trempé et verni dessous avec des teintes métallisées Gris Lave, Cuivre Marron ou Champagne. Base en métal verni, finition Gris Lave.

Couchtisch aus geschmolzenen und gehärtetem Glas 12 mm in den folgenden Metallfarben unterlackiert: Lavagrau, Kupfer braun oder champagnerfarbig. Untergestell aus Metall in der Farbvariante Lavagrau.

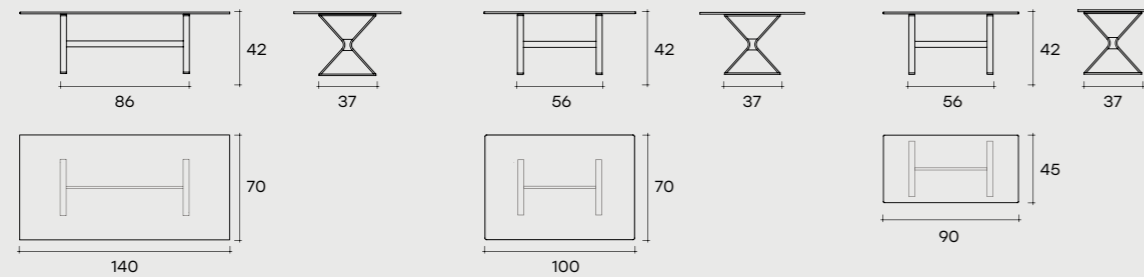

90 x 45 x 42 cm  
35 7/16" x 17 11/16" x 16 9/16"  
100 x 70 x 42 cm  
39 3/8" x 27 9/16" x 16 9/16"  
130 x 68 x 40 cm  
55 1/8" x 27 9/16" x 16 9/16"

Piano in vetro fuso  
Fused glass top

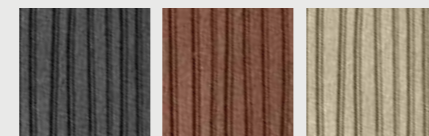

grigio lava  
lava grey    marrone ramato  
copper brown    champagne  
champagne



lakes

DESIGN  
STUDIO KLASS

Tavolino con piano in vetro da 10 mm fuso a gran fuoco, retroverniciato con tinte metallizzate Grigio Lava, Marrone Ramato, Blu Notte o Champagne. Base in metallo verniciato, finitura Grigio Lava o Champagne metallizzato.

Coffee table with 10 mm fused, back-lacquered glass top with metal shades Lava Grey, Copper Brown, Night Blue or Champagne. Metal painted base available in Lava Grey or metallic Champagne finishes.

Table basse avec plateau en verre en fusion de 12 mm, trempé et verni dessous avec des teintes métallisées Gris Lave, Cuivre Marron ou Champagne. Base en métal verni, finition Gris Lave.

Couchtisch aus geschmolzenen und gehärtetem Glas 12 mm in den folgenden Metallfarben unterlackiert: Lavagrau, Kupfer braun oder champagnerfarbig. Untergestell aus Metall in der Farbvariante Lavagrau.

Ø 100 x 40 cm  
Ø 39 3/8" x 15 3/4"  
Ø 70 x 45 cm  
Ø 27 9/16" x 17 11/16"  
Ø 50 x 50 cm  
Ø 19 1/16" x 19 1/16"

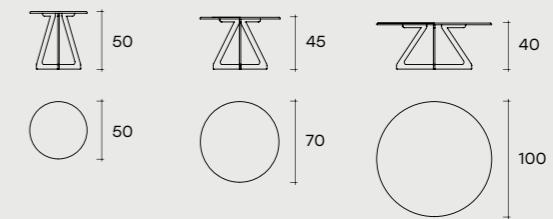

Base in metallo  
Metal base

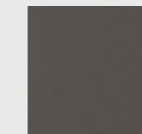

grigio lava  
lava grey

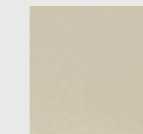

champagne metallizzato  
metallic champagne

Piano in vetro fuso  
Fused glass top

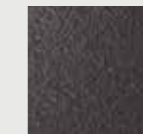

grigio lava  
lava grey

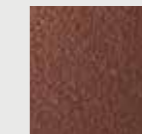

marrone ramato  
copper brown

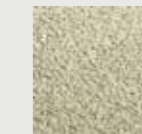

champagne  
champagne



blu notte  
night blue



## macramè

DESIGN  
LUCIDI PEVERE

Collezione di tavolini composti da una base in vetro filato intrecciato in maniera artigianale e da un piano di vetro da 10 mm. La collezione di tavolini prevede le seguenti finiture: piano in vetro extralight con base in vetro extralight, piano in vetro bronzo con base verniciata bronzo, piano in vetro fumè con base verniciata fumè.

Collection of coffee tables comprising hand-interwoven spun glass base and 10 mm-thick glass top. The coffee table collection includes the following finishes: extralight glass top with extralight glass base; bronze glass top with bronze painted base; smoked glass top with smoked grey painted base.

Tables basses composées d'une base en verre filé tressé de manière artisanale et d'un plateau en verre de 10 mm. La collection de tables basses propose les finitions suivantes: plateau verre extralight avec base en verre extralight, plateau en verre bronze avec base peinte coloris bronze, plateau en verre fumé avec base peinte coloris fumé.

Tisch mit Unter-Untergestell aus handwerklich gefertigtem Glasfädengeflecht und 10 mm starker Glasplatte. Lieferbar in den Finishes: Glasplatte und Untergestell aus extralight Glas, Bronzeglas Platte mit Untergestell Bronze lackiert, Rauchglas Platte mit Untergestell Rauch lackiert.

90 x 65 x 33 cm  
35 7/16" x 25 9/16" x 13  
60 x 60 x 40 cm  
23 5/8" x 23 5/8" x 15 3/4"  
50 x 50 x 50 cm  
19 11/16" x 19 11/16" x 19 11/16"

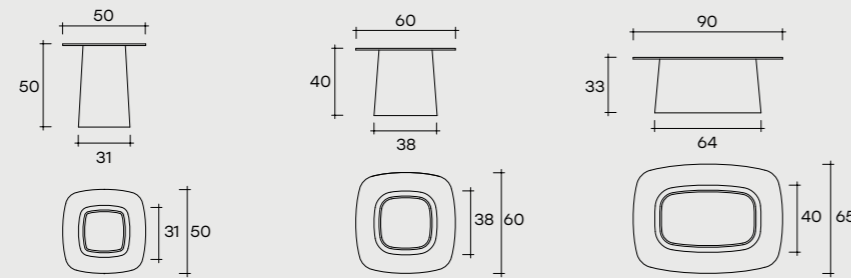

## macramè large

DESIGN  
LUCIDI PEVERE

Tavolino composto da una base in vetro filato intrecciato in maniera artigianale e da un piano di vetro da 10 mm nelle seguenti finiture: piano extralight con base in vetro extralight, piano bronzo con base verniciata bronzo, piano in vetro fumè con base verniciata fumè.

Coffee table comprising hand-interwoven spun glass base and 10 mm glass top available the following finishes: extralight top with extralight glass base; bronze top with bronze painted base; smoked glass top with smoked grey painted base.

Table basse composée d'une base en verre filé tressé de manière artisanale et d'un plateau en verre de 10 mm proposée dans les finitions suivantes : plateau verre extralight avec base en verre extralight, plateau bronze avec base peinte coloris bronze, plateau en verre fumé avec base peinte coloris fumé.

Couchtisch mit Untergerstell aus handwerklich gefertigtem Glasfädengeflecht und 10 mm starker Glasplatte. Lieferbar in den Finishes: extralight Glasplatte mit Untergerstell aus extralight Glas, Platte Bronze mit Untergerstell lackiert Bronze, Rauchglas Platte mit Untergerstell Rauch lackiert.

130 x 86 x 33 cm  
51 3/16" x 33 7/8" x 12"

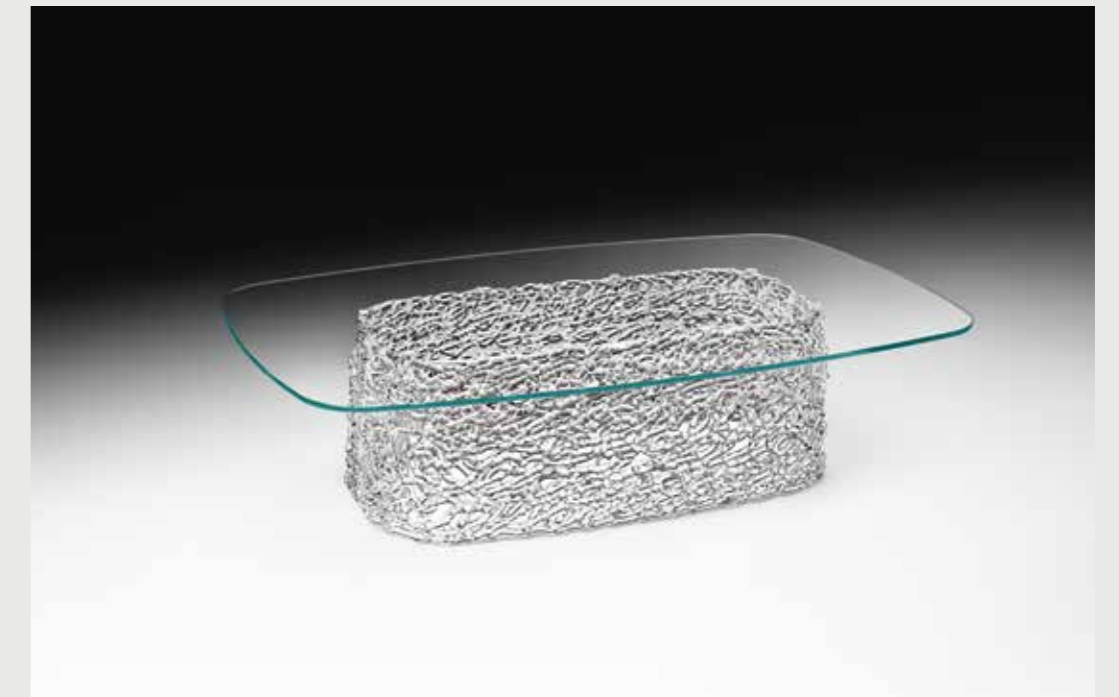
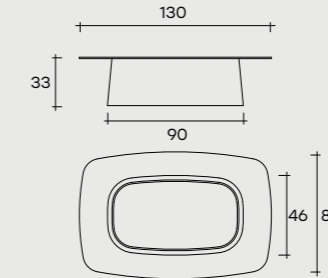



# magique

DESIGN  
STUDIO KLASS

Tavolino con cubo contenitore in vetro da 10 mm. Disponibile in diverse finiture.

Coffee table with cubic inner compartment in 10 mm-thick glass. Available in various finishes.

Table d'appoint avec cube-rangement en verre soudé de 10 mm. Disponible en plusieurs finitions.

Beistelltisch mit Behälter aus 10 mm starkem, geschweißtem Glas. Lieferbar in diversen Finishes.

32 x 32 x 56 cm  
12 5/8" x 12 5/8" x 22 1/16"

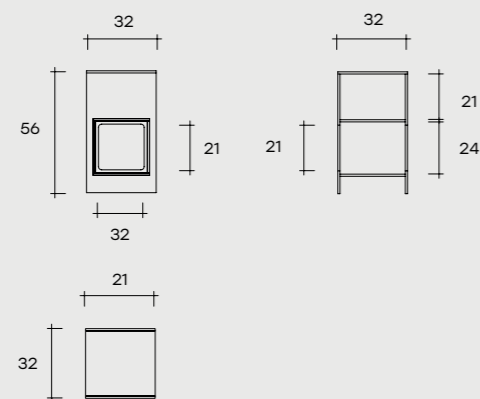

# magma

DESIGN  
PATRICK JOUIN

Tavolino con piano in vetro da 12 mm fuso a gran fuoco e temperato, disponibile nelle tinte trasparenti Fumo, Blu, Ambra o Naturale effetto satinato. Struttura in legno massello disponibile nelle finiture rovere naturale o tinto grigio.

Coffee table with 12 mm fused and tempered glass top, available in Smoke grey, Blue, Amber or Natural satin finish. Solid wood structure available in natural or grey oak finish.

Table basse avec plateau en verre en fusion de 12 mm trempé, disponible dans les teintes transparentes Fumées, Bleues, Ambres ou Naturel effet satiné. Structure en bois massif de chêne disponible dans les finitions naturelle ou de couleur grise.

Couchtisch mit Platte aus 12 mm geschmolzenem und gehärtetem Glas in den folgenden Ausführungen erhältlich: Rauch, Blau, Bernstein oder transparent mit satiniertem Effekt. Untergestell aus massivem Eichenholz in den folgenden Ausführungen erhältlich: Natur- oder Grau-gefärbt.

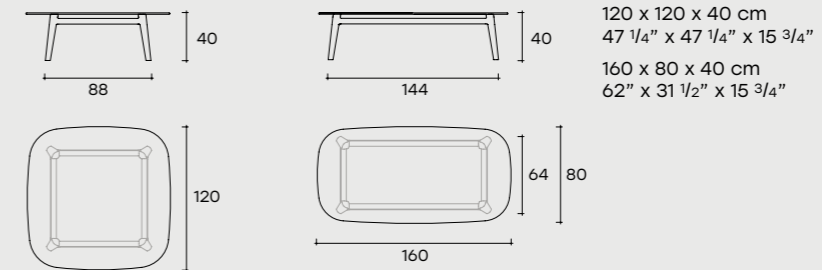

**Struttura in legno**  
Wood structure

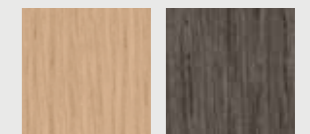

finitura rovere naturale  
natural oak finish

finitura rovere tinto grigio  
grey finish oak



**Piano in vetro**  
Glass top

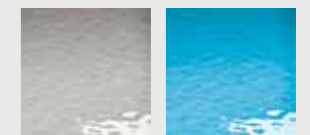

fumo  
smoke grey

blu  
blue



ambra  
amber

naturale effetto satinato  
natural satin finish



# neutra

DESIGN  
RODOLFO DORDONI



Tavolo basso monolitico in vetro curvato da 12 mm. A richiesta, disponibile anche in vetro extralight, vetro extralight retroverniciato bianco e in vetro retroverniciato nero.

Monolithic coffee table in 12 mm-thick curved glass. On demand also available in extralight glass, extralight white back-stained glass and in black back-stained glass.

Table basse d'une seule dalle de verre cintré de 12 mm. Sur demande disponible aussi en verre extralight, verre extralight verni dessous blanc ou verre verni dessous noir.

Couchtisch aus einer einzigen 12 mm-starken gebogenen Glasplatte gefertigt. Auf Wunsch lieferbar auch aus extralight-Glas, extralight-Glas mit weisser Hintergrundlackierung, oder mit schwarzer Hintergrundlackierung.

106 x 106 x 27 cm  
41 3/4" x 41 3/4" x 10 5/8"

126 x 126 x 30 cm  
49 5/8" x 49 5/8" x 11 3/4"

146 x 66 x 28 cm  
51 3/16" x 26" x 11"

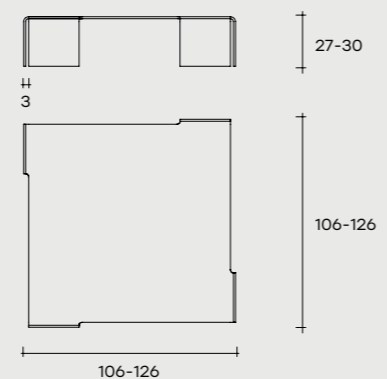
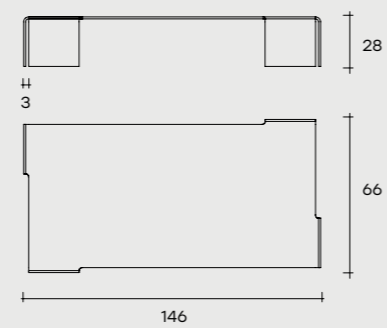
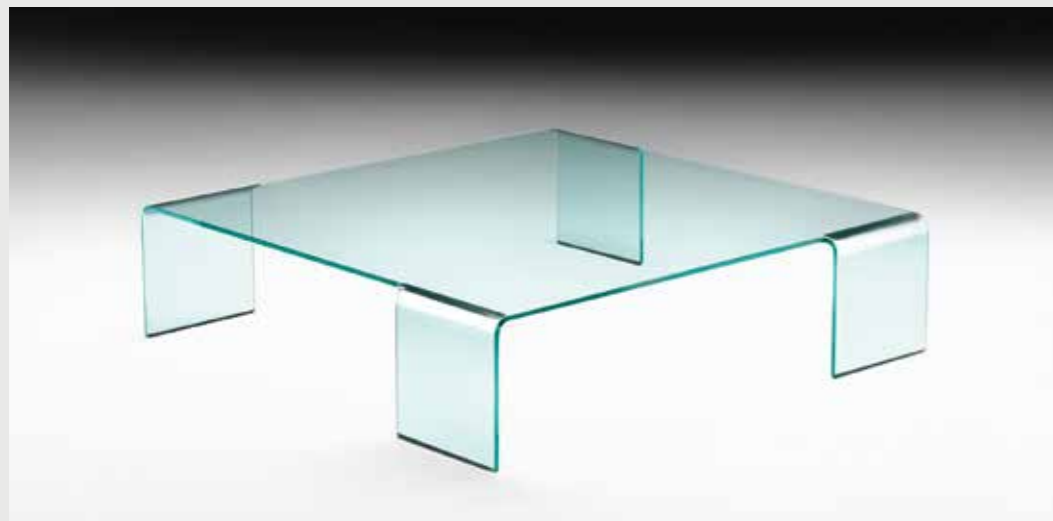

# pixel

DESIGN  
VITTORIO LIVI

Tavolino con piano in vetro Multicolor e base in metallo finitura Titanio opaco.

Coffee table with Multicolor glass top and opaque titanium finish metal base.

Table basse avec plateau en verre Multicolore et base en métal finition Titane opaque.

Couchtisch mit Platte aus buntem Glas. Untergestell aus Metall in der matt Titan-Ausführung.

44 x 44 x 50 cm  
17 5/16" x 17 5/16" x 19 11/16"

62 x 62 x 30 cm  
24 7/16" x 24 7/16" x 11 13/16"

80 x 37 x 40 cm  
31 1/2" x 14 9/16" x 15 3/4"

92 x 49 x 40 cm  
36 1/4" x 19 5/16" x 15 3/4"

122 x 67 x 35 cm  
48" x 26 3/8" x 13 3/4"

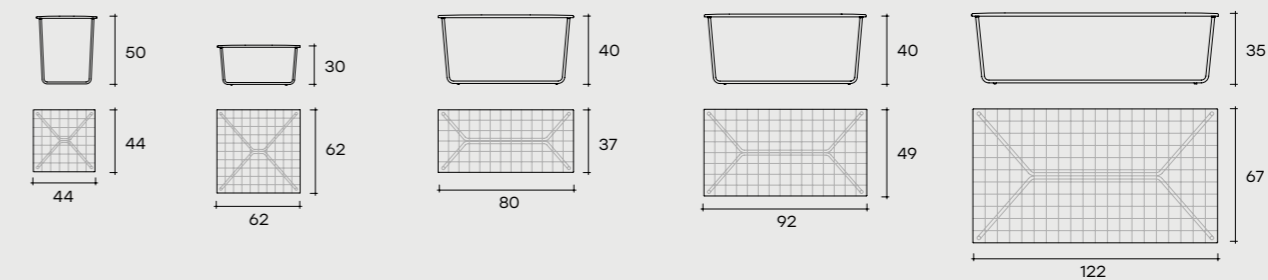

# ponte

DESIGN  
ANGELO CORTESI



Tavolo basso monolitico  
in vetro curvato  
da 10, 12 o 19 mm.

Monolithic coffee table  
in 10, 12 or 19 mm-thick  
curved glass.

spessore / thickness  
épaisseur / Stärke  
10 mm

60 x 60 x 40 cm  
23 5/8" x 23 5/8" x 15 3/4"  
90 x 90 x 40 cm  
35 7/16" x 35 7/16" x 15 3/4"  
100 x 60 x 40 cm  
39 3/8" x 23 5/8" x 15 3/4"

Table basse d'une seule  
dalle de verre cintré  
de 10, 12 o 19 mm.

Couchtisch aus 10,  
12 oder 19 mm-starkem  
gebogenem Glas.

spessore / thickness  
épaisseur / Stärke  
12 mm

120 x 120 x 40 cm  
47 1/4" x 47 1/4" x 15 3/4"  
130 x 70 x 40 cm  
51 3/16" x 27 9/16" x 15 3/4"  
120 x 60 x 40 cm  
47 1/4" x 23 5/8" x 15 3/4"

spessore / thickness  
épaisseur / Stärke  
19 mm

120 x 60 x 40 cm  
47 1/4" x 23 5/8" x 15 3/4"  
130 x 70 x 40 cm  
51 3/16" x 27 9/16" x 15 3/4"  
160 x 50 x 40 cm  
63" x 19 11/16" x 15 3/4"

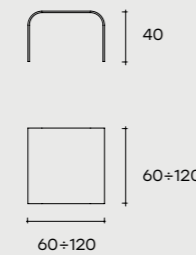
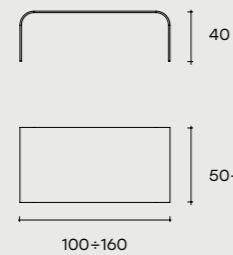

# quadra

DESIGN  
MATTEO NUNZIATI



Tavolino contenitore  
composto da 4 elementi  
in vetro curvato da 10 mm  
interposti tra 2 piani  
in vetro da 10 mm.  
Piano superiore e divisori  
in vetro extralight;  
basi nelle seguenti  
varianti: vetro extralight  
trasparente, vetro  
extralight retroverniciato,  
vetro extralight  
retroargentato, vetro  
bronzo retroargentato.

Coffee table/storage  
unit composed of 4  
elements in 10 mm  
curved glass mounted  
between two 10 mm glass  
racks. Top and partitions  
in extralight glass, bases  
available in extralight  
extralight glass,  
extralight mirrored  
extralight glass, back-silvered  
bronze glass.

Table basse de rangement  
constituée de 4 éléments  
en verre cintré de 10 mm  
interposés entre 2  
plateaux en verre  
de 10 mm. Plateau  
supérieur et cloisons  
en verre extralight  
transparent ; bases dans  
les variantes suivantes :  
verre extralight  
transparent, verre  
extralight verni dessous  
blanc, verre extralight  
argenté, verre bronze  
argenté, verre noir 95.

Couchtisch mit  
Stauraum aus vier  
Elementen aus 10 mm  
starkem, gebogenem  
Glas zwischen zwei  
10 mm starken  
Glasplatten. Obere Platte  
und Trennelemente  
aus Extralight-Glas,  
Basis in den folgenden  
Ausführungen:  
Extralight-Glas,  
Extralight-Glas  
hinterlackiert weiß,  
Extralight-Glas.



90 x 90 x 30 cm  
35 7/16" x 35 7/16" x 11 13/16"  
120 x 120 x 30 cm  
47 1/4" x 47 1/4" x 11 13/16"  
160 x 80 x 34 cm  
62" x 31 1/2" x 13 3/8"

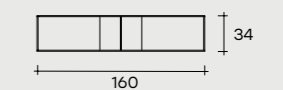
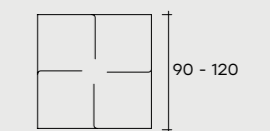
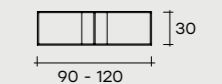

# rialto

DESIGN  
CRS FIAM



Tavolo basso in vetro curvato da 10, 12 o 15 mm.  
Disponibile anche in vetro extralight.  
È possibile realizzare Rialto su misura.

Coffee table in 10, 12 or 15 mm-thick curved glass.  
Also available in extralight glass and customized sizes.

quadrato / square  
carré / Viereckige

spessore / thickness  
épaisseur / Stärke  
15 mm

120 x 120 x 32 cm  
47 1/5" x 247 1/4" x 12 5/8"

120 x 120 x 42 cm  
47 1/5" x 247 1/4" x 16 9/16"

130 x 130 x 32 cm  
51 3/16" x 51 3/16" x 12 5/8"

Table basse en verre de 10, 12 ou 15 mm.  
Disponible aussi en verre extralight et sur mesure.

Couchtisch aus 10, 12 oder 15 mm-starkem gebogenem Glas.  
Lieferbar auch aus extralight-Glas.  
Der Rialto kann nach Maß bestellt werden.

130 x 130 x 42 cm  
51 3/16" x 51 3/16" x 16 9/16"

140 x 140 x 32 cm  
55 1/8" x 55 1/8" x 12 5/8"

140 x 140 x 42 cm  
55 1/8" x 55 1/8" x 16 9/16"

rettangolare / rectangular  
rectangulaire / Rechteckig

spessore / thickness  
épaisseur / Stärke  
10 mm

100 x 60 x 32 cm  
39 3/8" x 23 5/8" x 12 5/8"

spessore / thickness  
épaisseur / Stärke  
12 mm

120 x 60 x 32 cm  
47 1/4" x 23 5/8" x 12 5/8"

130 x 68 x 32 cm  
51 3/16" x 26 3/4" x 12 5/8"

120 x 60 x 43 cm  
47 1/4" x 23 5/8" x 16 15/16"

130 x 68 x 43 cm  
51 3/16" x 26 3/4" x 16 15/16"

spessore / thickness  
épaisseur / Stärke  
15 mm

160 x 52 x 22 cm  
63" x 20 1/2" x 8 11/16"

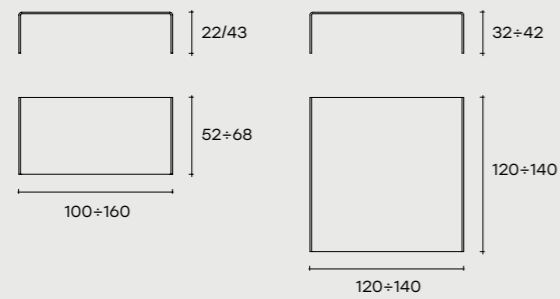

# rialto piano

DESIGN  
CRS FIAM



Tavolo basso in vetro curvato da 10\* o 12 mm.  
Ripiano in vetro da 10\* mm o 12 mm.  
Disponibile anche in vetro extralight.  
È possibile realizzare Rialto piano su misura.

Coffee table in 10\* or 12 mm-thick curved glass with 10\* or 12 mm-thick glass shelf.  
Also available in extralight glass and customized sizes.

Table basse en verre cintré de 10 mm\* ou 12 mm.  
Avec étagère en verre de 10\* ou 12 mm.  
Disponible aussi en verre extralight et sur mesure.

Couchtisch aus 10\* oder 12 mm-starkem gebogenem Glas mit 10\* oder 12 mm-starker Glasablageplatte.  
Lieferbar auch aus extralight-Glas.  
Der Rialto piano kann nach Maß bestellt werden.

\*100 x 60 x 32 cm  
\*39 3/8" x 23 5/8" x 12 5/8"

120 x 60 x 32 cm  
47 1/4" x 23 5/8" x 12 5/8"

130 x 68 x 32 cm  
51 3/16" x 26 3/4" x 12 5/8"

120 x 60 x 43 cm  
47 1/4" x 23 5/8" x 16 15/16"

130 x 68 x 43 cm  
51 3/16" x 26 3/4" x 16 15/16"

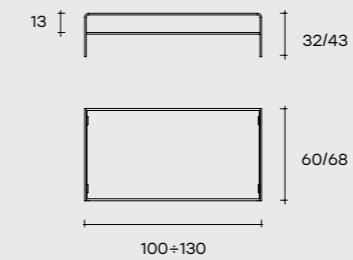

## rialto side

DESIGN  
CRS FIAM



Tavolo di servizio in vetro curvato da 12 mm.  
Ripiano in vetro da 12 mm.  
Disponibile anche in vetro extralight.  
È possibile realizzare Rialto side su misura.

Side-table in 12 mm-thick curved glass.  
Shelf in 12 mm-thick glass.  
Also available in extralight glass and customized sizes.

Table d'appoint en verre cintré de 12 mm avec étagère en verre de 12 mm.  
Disponible aussi en verre extralight et sur mesure.

Beistelltisch mit Basis aus 12 mm-starkem gebogenem Glas mit Einlegeboden aus 12 mm-starkem Glas.  
Lieferbar auch aus extralight-Glas.  
Der Rialto side kann nach Maß bestellt werden.

85 x 32 x 55 cm  
33 7/16" x 12 5/8" x 21 5/8"

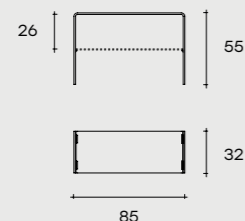

## rialto tris

DESIGN  
CRS FIAM



Composizione di tavoli bassi in vetro curvato da 10 mm. Disponibile anche in vetro extralight e NERO 95 o in vetro bronzo retroargentato.  
È possibile realizzare Rialto tris su misura.

Set of coffee tables in 10 mm-thick curved glass. Also available in extralight glass, Black 95 (NERO 95) glass or back-silvered bronze glass and in customized sizes.

Composition de tables basses en verre cintré de 10 mm. Disponible aussi en verre extra-clair, verre Noir95, verre bronze ou verre bronze dessous argenté.

Komposition von Couchtischen aus gebogenem Glas 10 mm. Auch in den folgenden Ausführungen lieferbar: extralight Glas oder Schwarz95 Glas oder Bronze Glas oder versilbertes Bronzeglas.



39,5 x 40 x 37,5 cm  
15 9/16" x 15 3/4" x 14 3/4"  
47,5 x 45 x 41,5 cm  
18 11/16" x 17 11/16" x 16 5/16"  
55,5 x 50 x 45,5 cm  
21 7/8" x 19 11/16" x 17 15/16"

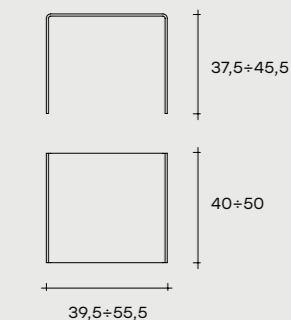

roy

DESIGN DORIANA  
E MASSIMILIANO FUKSAS

Tavolino composto da un piano in vetro trasparente in appoggio su base di forma concava in vetro da 10 mm curvato retroargentato. 4 gambe smontabili verniciate nere, con piedini in acciaio spazzolato.

Coffee table consisting in a transparent top resting on a concave base in 10 mm curved glass, back-silvered, mounted on 4 removable black painted legs with brushed steel feet.

Table basse constituée d'un plateau en verre transparent sur base en verre cintré de 10 mm, de forme concave, verni dessous argent. 4 pieds démontables en acier brossé peintes en noir.

Couchtisch mit transparenter Glasplatte auf einem Untergestell aus gebogenem Glas, Stärke 10mm., mit versilberter Rückseite und konkaver Form. Vier abnehmbare schwarz lackierte Beine mit Füßchen aus geburstedem Stahl.

Ø 120 x 40 cm  
Ø 47 1/4" x 15 3/4"

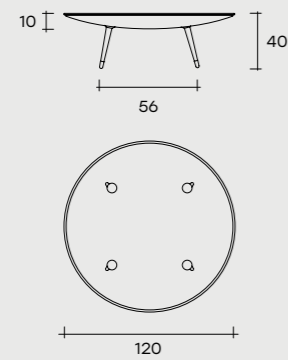

shell

DESIGN  
DANNY LANE

Tavolo basso con piano in vetro scolpito a mano da 15 mm. Base a cinque elementi in vetro scolpito a mano da 12 mm, di cui quattro curvati. Parti metalliche in acciaio inox.

Coffee table with hand-sculptured 15 mm-thick glass top. Base made of five 12 mm-thick hand-sculptured glass elements, four of which curved. Hardware in stainless steel.

Table basse avec plateau en verre de 15 mm sculpté à la main. Le piétement se compose de cinq éléments en verre de 12 mm aussi sculptés à la main, quatre sont cintrés. Détails métalliques en acier inox.

Couchtisch mit handbehauener 15-mm starker Glasplatte. Untergestell aus fünf handbehauenen Elementen aus 12 mm-starkem Glas, vier sind gebogen. Metallteile aus rostfreiem Stahl.

125 x 125 x 40 cm  
49 3/16" x 49 3/16" x 15 3/4"

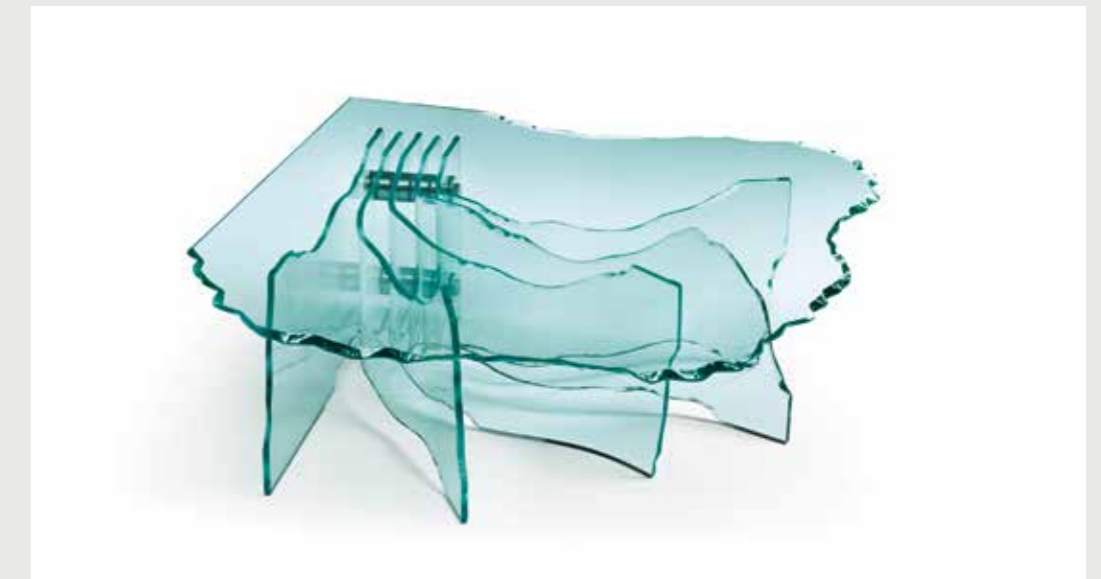
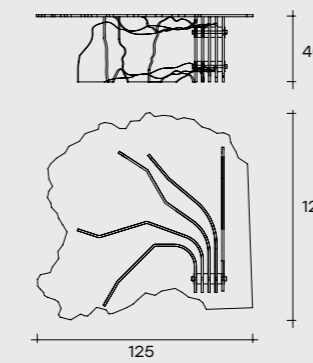

sigmy

DESIGN  
AQUILI - ALBERG

Tavolo di servizio in vetro curvato da 12 mm per la versione vetro trasparente o extralight, 10 mm per la versione Nero 95.

Side table in curved glass of 12 mm for the transparent or extralight glass version and 10 mm for the Black 95.

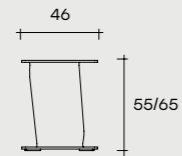

Table d'appoint en verre cintré de 12 mm pour la version en verre transparent ou extralight, de 10 mm pour la version Noir 95.

Beistelltisch aus 12 mm starkem, gebogenem, transparentem oder Extralight Glas, 10 mm starkem Glas Schwarz 95.

46 x 46 x 55 cm  
18 1/8" x 18 1/8" x 21 5/8"  
46 x 46 x 65 cm  
18 1/8" x 18 1/8" x 25 9/16"

toki

DESIGN  
SETSU & SHINOBU ITO

Comodino monolitico in vetro curvato da 10 mm.

Monolithic bedside table in 10 mm-thick curved glass.

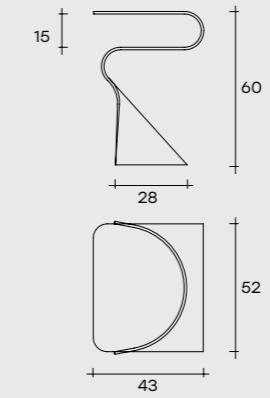

Table de chevet d'une seule dalle de verre cintré de 10 mm.

Nachttisch aus 10 mm-starkem gebogenem Glas, aus einer einzigen Glasplatte gefertigt.

52 x 43 x 60 cm  
20 1/2" x 16 15/16" x 23 5/8"



## waves

DESIGN LUDOVICA  
+ ROBERTO PALOMBA

Tavolino con piano  
in DV Glass da 23 mm  
trasparente o a strisce  
colorate. Base in metallo  
finitura Titanio opaco  
oppure Nichel Nero lucido.

Coffee table with  
top made of 23 mm  
DV Glass available in  
transparent or in line  
colored glass. Metal base  
in opaque Titanium  
or in Black Glossy Nickel.

Table basse avec  
plateau en DV Glass  
de 23 mm transparent o  
u avec bandes colorées.  
Base en métal,  
finition Titane opaque  
ou Nickelanoir brillant.

DV Glass, Stärke 23 mm,  
in der Ausführung  
transparent oder mit  
farbigen Streifen  
erhältlich. Untergestell aus  
Metall in den folgenden  
Farbvarianten: Matt Titan  
oder Glanz Schwarz Nickel.

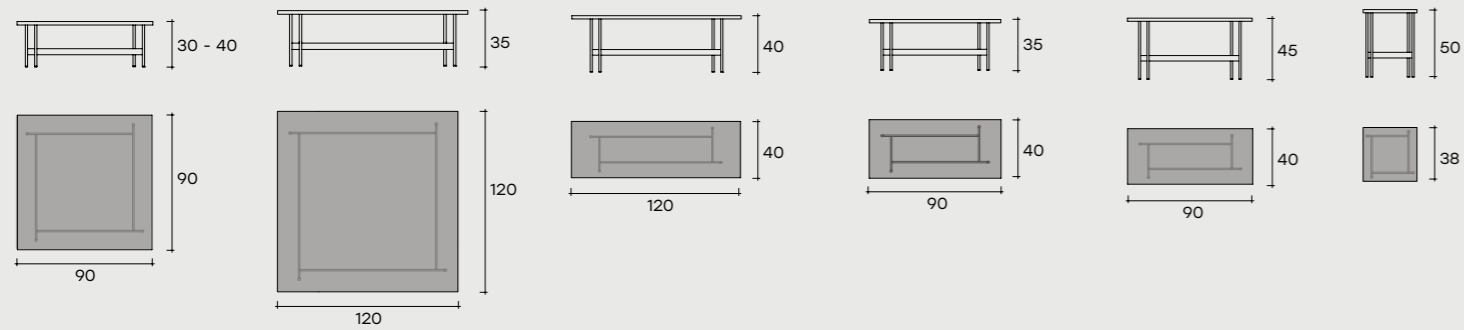

90 x 90 x 30 cm  
35 7/16" x 35 7/16" x 15 3/4"  
90 x 90 x 40 cm  
35 7/16" x 37 7/16" x 15 3/4"  
120 x 120 x 35 cm  
47 1/4" x 47 1/4" x 13 3/4"  
120 x 40 x 40 cm  
47 1/4" x 15 3/4" x 15 3/4"  
90 x 40 x 35 cm  
35 7/16" x 15 3/4" x 13 3/4"  
90 x 40 x 45 cm  
35 7/16" x 15 3/4" x 17 1/16"  
38 x 38 x 50 cm  
15" x 15" x 19 1/16"

**Struttura**  
Structure



titanio opaco  
opaque titanium

**Piano in DV-Glass**  
DV-Glass top



vetro fuso trasparente  
fused transparent glass

**Struttura**  
Structure



nichel nero lucido  
black glossy nickel

**Piano in DV-Glass**  
DV-Glass top



vetro fuso colorato  
fused colored glass

## charlotte de nuit

DESIGN  
PROSPERO RASULO



Comodino in vetro  
curvato da 8 mm.  
Ripiano opzionale in vetro  
curvato acidato da 6 mm.  
Disponibile anche  
in vetro extralight.

Bedside table in  
8 mm-thick curved  
glass. Also available  
in extralight glass.  
Optional shelf  
in 6 mm-thick  
acid-etched  
curved glass.

Table de chevet  
en verre cintré de 8 mm.  
Disponibile aussi  
en verre extralight.  
Étagère en verre cintré  
dépoli de 6 mm.  
sur demande.

Nachttisch aus  
8 mm-starkem  
gebogenem Glas.  
Lieferbar auch  
aus extralight-Glas.  
Auf Wunsch:  
Einlegeboden  
aus geätztem  
6 mm-starkem  
gebogenem Glas.

51 x 40 x 54 cm  
20 1/16" x 15 3/4" x 21 1/4"

ripiano / shelf  
étagère / Einlegeboden  
37 x 39,5 x 1,5 cm  
14 9/16" x 15 9/16" x 9/16"

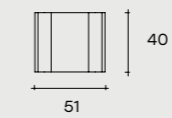
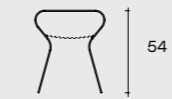



# dino

DESIGN  
CRS FIAM

Comodino in vetro curvato da 8 mm con cassetto in legno laccato colore bianco, nero o testa di moro e frontalino in vetro da 8 mm verniciato in tinta.

Bedside table in 8 mm-thick curved glass with lacquered wood drawer white, black or dark brown. Front panel in 8 mm glass painted in matching colours.

Chevet en verre cintré de 8 mm avec tiroir en bois laqué blanc, noir ou marron et façade en verre de 8 mm verni de la même couleur.

Beistelltisch aus gebogenem Glas 8 mm und lackierte Holzschublade in den folgenden Farbvarianten erhältlich: weiß, schwarz, dunkelbraun. 8 mm lackierte Glasfront.

45 x 46 x 50 cm  
17 11/16" x 18 1/8" x 19 11/16"

#### Cassetto Drawer



bianco  
white



nero  
black



marrone testa di moro  
dark brown

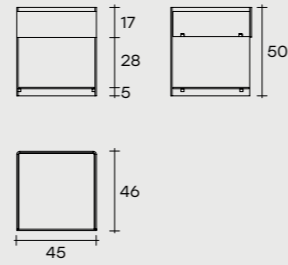

# grillo

DESIGN  
VITTORIO LIVI



Comodino in vetro curvato da 12 mm.

Bedside table in 12 mm-thick curved glass.

Table de chevet en verre cintré de 12 mm.

Nachttisch aus 12 mm-starkem gebogenem Glas.

53 x 42 x 60 cm  
20 7/8" x 16 9/16" x 23 5/8"

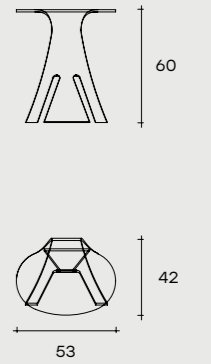

## magique cubo

DESIGN  
CRS FIAM

Comodino con cubo contenitore in vetro saldato da 10 mm disponibile in diverse finiture.

Bedside table with cubic inner compartment in 10-mm thick welded glass. Available in various finishes.

Chevet avec cube rangement en verre soudé de 10 mm disponible dans plusieurs finitions.

Beistelltisch mit offener Cube-Box aus 10mm starkem geschweißtem Glas in diversen Finishes.

38 x 34 x 48 cm  
15" x 13 3/8" x 18 7/8"

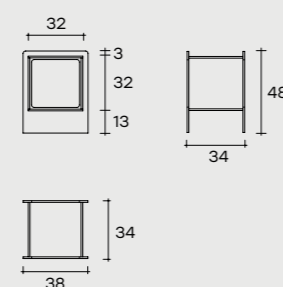

## milo

DESIGN  
ILARIA MARELLI

Comodino con struttura in vetro curvato da 8 mm trasparente o fumé. Dotazione: ripiano in vetro da 8 mm trasparente o fumé, retroverniciato nero o extralight retroverniciato bianco, cassetto in legno laccato bianco o nero con frontale in vetro. Reggipiani in vetro. Il comodino può essere dotato di 2, 3 ripiani oppure 2 ripiani ed un cassetto. Disponibile anche in vetro extralight.

Bedside table in curved transparent or smoked glass, 8 mm-thick. Accessories: 8 mm-thick glass shelf in the following finishing options: transparent or smoked glass, black back-stained glass, extralight white back-stained glass; wooden drawer black or white lacquered, with glass front back-stained respectively black or white. Glass shelf supports. The bedside table can be fitted with 2,3 shelves or 2 shelves and one drawer. Also available in extralight glass.

Table de chevet en verre cintré de 8 mm transparent ou fumé, étagères en verre de 8 mm transparent ou fumé, verni dessous noir ou extralight verni dessous blanc, tiroir en bois teinté blanc ou noir avec frontal en verre verni aussi blanc ou noir. Supports étagère en verre. Le chevet peut être équipé de 2, 3 étagères ou de 2 étagères et un tiroir. Disponible aussi en verre extralight.

Nachttisch aus gebogenem, transparentem- oder Rauch-Glas, 8 mm Stärke. Ausrüstung: 8 mm-starkem Glasfachboden aus transparentem- oder Rauch-Glas, schwarz-lackiertem Glas, extralight weiss-lackiertem Glas; Holzschublade schwarz oder weiss lackiert mit entsprechend Glasfront schwarz oder weiss. Fachbodenträger aus Glas. Der Nachttisch kann mit 2, 3 Fachböden bzw. 2 Fachböden und einer Schublade ausgestattet werden. Lieferbar auch aus extralight-Glas.

45 x 45 x 50 cm  
17 1/16" x 17 1/16" x 19 1/16"

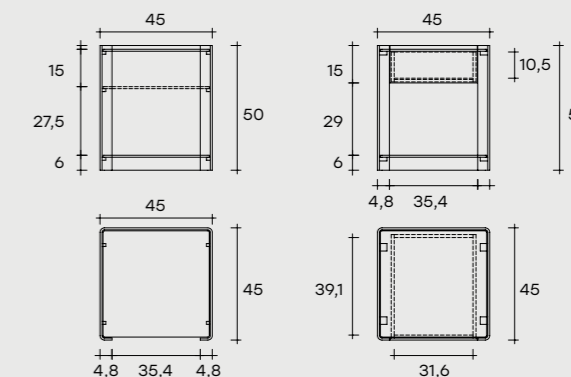

## rialto night

DESIGN  
CRS FIAM



Comodino in vetro curvato da 8 mm. Disponibile con ripiano in vetro da 8 mm o con cassetto in finitura legno nelle varianti: rovere tabacco, olmo o laccato bianco.

Bedside table in 8 mm-thick curved glass. Available with 8 mm-thick glass shelf or with wood drawer, finish: tobacco oak, elm or white lacquered.

Table de chevet en verre cintré de 8 mm. Disponible avec étagère en verre de 8 mm. ou avec tiroir en bois finition : chêne coloris tabac, orme ou laqué blanc.

Nachttisch aus 8 mm-starkem gebogenem Glas. Verfügbar mit Fachboden aus 8 mm starkem Glas oder mit Schublade Finish: Steineichholz Tabak, Ulme oder lackiert Weiß.

47,5 x 45 x 45 cm  
18 11/16" x 17 11/16" x 17 11/16"

47,5 x 45 x 60 cm  
18 11/16" x 17 11/16" x 23 5/8"

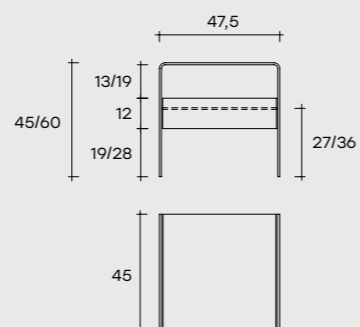

## toki

DESIGN  
SETSU & SHINOBU ITO

Comodino monolitico in vetro curvato da 10 mm.

Monolithic bedside table in 10 mm-thick curved glass.

Table de chevet d'une seule dalle de verre cintré de 10 mm.

Nachttisch aus 10 mm-starkem gebogenem Glas, aus einer einzigen Glasplatte gefertigt.

52 x 43 x 60 cm  
20 1/2" x 16 15/16" x 23 5/8"

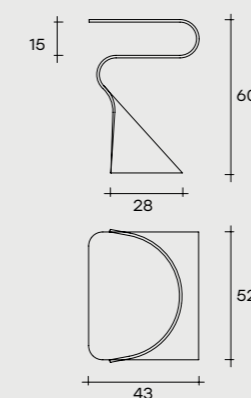

# charlotte

DESIGN  
PROSPERO RASULO



Consolle in vetro curvato da 15 mm. Disponibile anche con ripiano in vetro curvato acidato da 6 mm.

Consolle in 15 mm-thick curved glass. Also available with 10 mm-thick acid etched glass shelf.

Consolle en verre cintré de 15 mm. Disponible aussi avec étagère en verre cintré dépoli de 6 mm.

Konsole aus 15 mm-starkem gebogenem Glas. Auf Wunsch: gebogener Fachboden aus geätztem 6 mm-starkem Glas.

100 x 60 x 40 cm\*  
39 3/8" x 23 5/8" x 15 3/4"  
120 x 60 x 40 cm  
47 1/4" x 23 5/8" x 15 3/4"  
130 x 68 x 40 cm  
51 3/16" x 26 3/4" x 15 3/4"

ripiano / shelf  
étagère / Fachboden  
82,5 x 59 x 2,5 cm  
32 1/2" x 23" x 1"  
102,5 x 59 x 3,5 cm  
40 3/8" x 23" x 1 3/8"  
112,5 x 67 x 4 cm  
44 5/16" x 26 3/8" x 1 9/16"

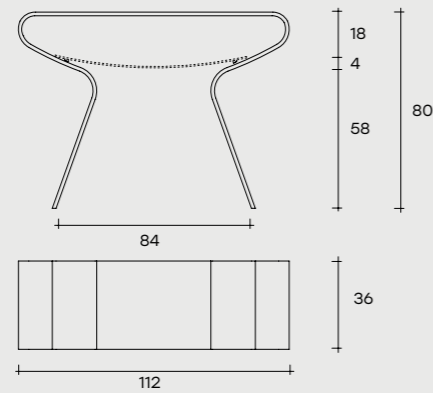

# dama

DESIGN  
MAKIO HASUIKE



Consolle monolitica in vetro curvato da 12 mm.

Monolithic console in 12 mm-thick curved glass.

Consolle d'une seule dalle de verre cintré de 12 mm.

Konsole aus 12 mm-starkem gebogenem Glas, aus einer einzigen Glasplatte gefertigt.

130 x 43 x 85 cm  
51 3/16" x 16 15/16" x 33 7/16"

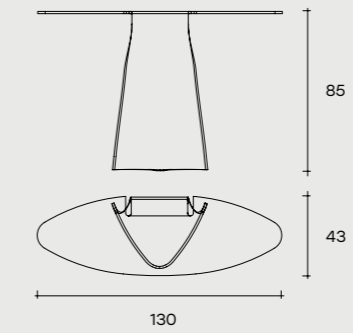

# elementare

DESIGN  
ENRICO TONUCCI



Consolle in vetro curvato da 12 mm. Disponibile anche con ripiano in vetro da 10 mm e in vetro extralight.

Console in 12 mm-thick curved glass. Also available with 10 mm-thick glass shelf and in extralight glass.

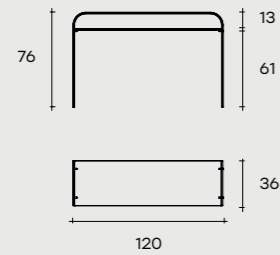

Console en verre cintré de 12 mm. Disponible aussi avec étagère en verre de 10 mm et en verre extralight.

Konsole aus 12 mm-starkem gebogenem Glas. Auch mit Fachboden aus 10 mm-starkem Glas und aus extralight Glas lieferbar.

120 x 36 x 76 cm  
47 1/4" x 14 3/16" x 29 5/16"

# hype

DESIGN  
STUDIO KLASS



Consolle con piano in vetro da 12 mm fuso a gran fuoco, temperato e retroverniciato con tinte metallizzate Grigio Lava, Marrone Ramato o Champagne. Base in metallo verniciato, finitura Grigio Lava.

Console with 12 mm fused, tempered and back-lacquered glass top with metal shades Lava Grey, Copper Brown or Champagne. Metal painted base, "Lava Grey" finish.

Console avec plateau en verre en fusion de 12 mm, trempé et verni dessous avec des teintes métallisées Gris Lave, Cuivre Marron ou Champagne. Base en métal verni, finition Gris Lave.

Konsole mit Platte aus 12 mm geschmolzenem und gehärtetem Glas in den folgenden Metallfarben unterlackiert: Lavagrau, Kupfer braun oder champagnerfarbig. Untergestell aus Metall in der Farbvariante Lavagrau.

140 x 45 x 75 cm  
55 1/8" x 17 11/16" x 29 1/2"  
180 x 45 x 75 cm  
70 7/8" x 17 11/16" x 29 1/2"

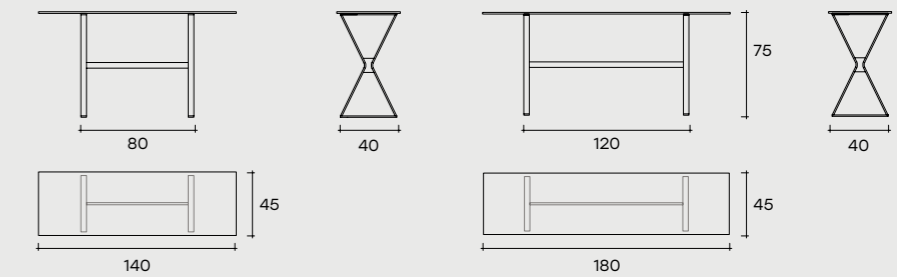

Piano in vetro fuso  
Fused glass top

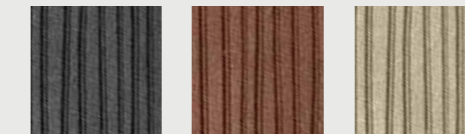

grigio lava  
lava grey

marrone ramato  
copper brown

champagne  
champagne

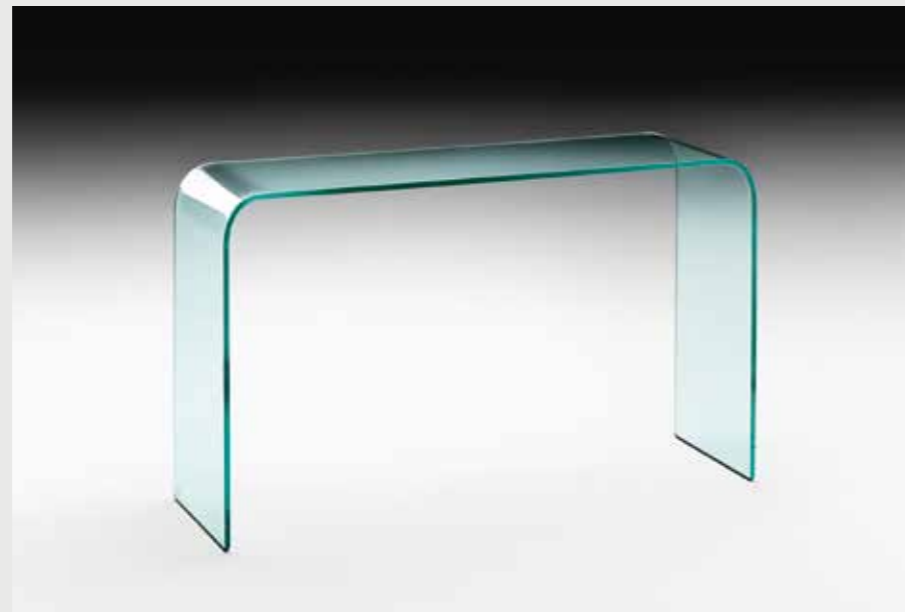

hype

DESIGN  
STUDIO KLASS

Scrivitoio con piano in vetro da 12 mm fuso a gran fuoco, temperato e retroverniciato con tinte metallizzate Grigio Lava, Marrone Ramato o Champagne. Base in metallo verniciato, finitura Grigio Lava.

Desk with 12 mm fused, tempered and back-lacquered glass top with metal shades Lava Grey, Copper Brown or Champagne. Metal painted base, "Lava Grey" finish.

Bureau avec plateau en verre en fusion de 12mm, trempé et verni dessous avec des teintes métallisées Gris Lave, Cuivre Marron ou Champagne. Base en métal verni, finition Gris Lave.

Schreibtisch mit Platte aus 12 mm geschmolzenem und gehärtetem Glas in den folgenden Metallfarben unterlackiert: Lavagrau, Kupfer braun oder champagnerfarbig. Untergestell aus Metall in der Farbvariante Lavagrau.

120 x 60 x 75 cm  
47 1/4" x 23 5/8" x 29 1/2"  
160 x 60 x 75 cm  
62" x 23 5/8" x 29 1/2"

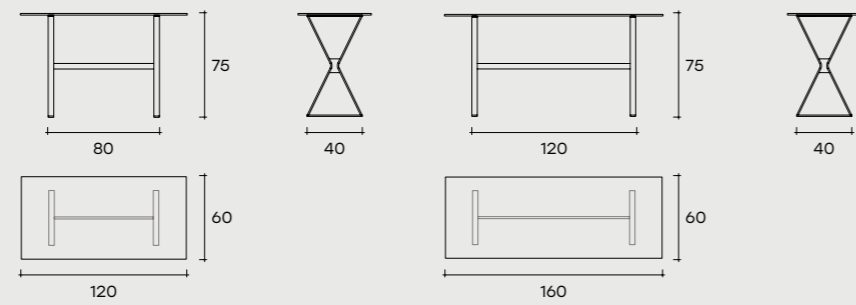

Piano in vetro fuso  
Fused glass top

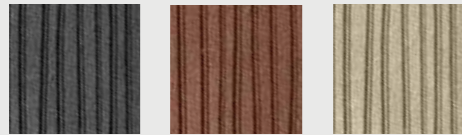

grigio lava  
lava grey

marrone ramato  
copper brown

champagne  
champagne



let me see

DESIGN  
RODOLFO DORDONI

Specchio consolle con ripiano in vetro curvato da 8 mm. Cornice in acciaio inox satinato.

Mirror console in 8 mm-thick curved glass. Frame in glazed stainless steel.

Miroir console avec étagère en verre cintré de 8 mm. Cadre en acier inox satiné.

Spiegel Konsole mit Ablage aus 8 mm-starkem gebogenem Glas. Rahmen aus rostfreiem satiniertem Stahl.

120 x 36 x 195 cm  
47 1/4" x 14 3/16" x 76 3/4"

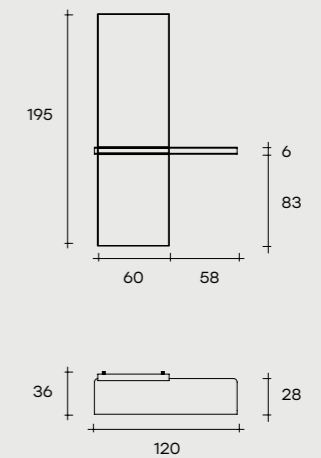

## LLT consolle

DESIGN  
DANTE O. BENINI  
E LUCA GONZO



Consolle con piano in vetro trasparente da 15 mm con bisellatura su due lati corti, struttura gambe in vetro trasparente saldato da 15 mm con bisellatura da 30 mm sul bordo. Particolari di fissaggio in acciaio inox. Disponibile anche su misura fino ad una lunghezza di 240 cm.

Consolle composed of a 15 mm thick transparent glass top with bevelled edges on the two shorter sides and of a base in 15 mm thick transparent welded glass with bevelled edge. Fastening elements in stainless steel. LLT Consolle is also available with custom-sized top up to 240 cm length.

Consolle se composant d'un plateau en verre transparent de 15 mm avec biseautage sur les deux côtés courts et d'un piétement en verre transparent soudé, épaisseur 15 mm, avec bords biseautés. Éléments de fixation en acier inoxydable. Également disponible avec plateau su mesure jusqu'à la longueur de 240 cm.

Konsole mit Platte aus transparentem 15 mm starkem Glas, Facettenschliff auf den zwei kürzeren Seiten. Untergestell aus transparentem 15 mm starkem verschweisstem Glas, 30 mm Facettenschliff auf den Kanten. Verbindungselemente aus Edelstahl. Auch mit Maßgefertigter Platte erhältlich bis max. Länge 240 cm.

180 x 40 x 85 cm  
70 7/8" x 15 3/4" x 33 7/16"  
240 x 40 x 85 cm  
94 1/2" x 15 3/4" x 33 7/16"

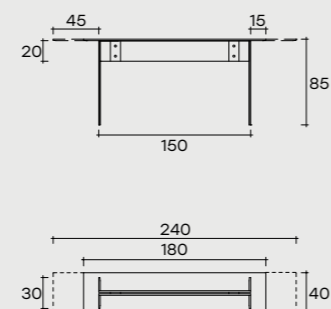

## lunar

DESIGN  
MATTEO NUNZIATI

Consolle con piano in vetro da 12 mm fuso a gran fuoco, temperato e retroverniciato con tinte metallizzate Grigio Lava o Champagne. Base in metallo verniciato, finitura Grigio Lava.

Consolle with 12 mm fused, tempered and back-lacquered glass top with metal shades Lava Grey or Champagne. Metal painted base, "Lava Grey" finish.

Consolle avec plateau en verre en fusion de 12 mm, trempé et verni dessous avec des teintes métallisées Gris Lave ou Champagne. Base en métal verni, finition Gris Lave.

Konsole mit Platte aus geschmolzenem und gehärtetem Glas 12 mm in den Metallfarben Lava Grau oder Champagner erhältlich. Untergestell aus Metall in der Farbvariante Lavagrau.

160 x 45 x 75 cm  
62" x 17 1/16" x 29 1/2"  
180 x 45 x 75 cm  
70 7/8" x 17 1/16" x 29 1/2"

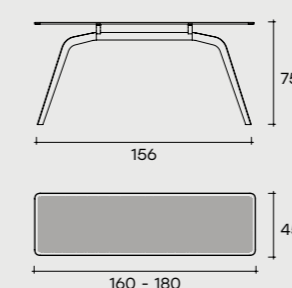

Piano in vetro fuso  
Fused glass top

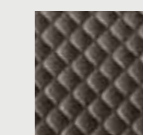

grigio lava  
lava grey

champagne  
champagne



# rialto consolle

DESIGN  
CRS FIAM



Consolle in vetro curvato da 12 mm. Disponibile anche con ripiano in vetro da 10 mm e in vetro extralight.

Console in 12 mm-thick curved glass. Also available with 10 mm-thick glass shelf and in extralight glass.

Console en verre cintré de 12 mm. Disponible aussi avec étagère en verre de 10 mm et en verre extralight.

Konsole aus 12 mm-starkem gebogenem Glas. Auch mit Fachboden aus 10 mm-starkem Glas und aus extralight Glas lieferbar.

100 x 36 x 75 cm  
39 3/8" x 14 3/16" x 29 1/2"

120 x 36 x 75 cm  
47 1/4" x 14 3/16" x 29 1/2"

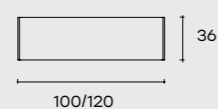
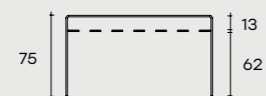

# waves

DESIGN LUDOVICA  
+ ROBERTO PALOMBA

Consolle con piano in DV Glass da 23 mm trasparente o a strisce colorate. Base in metallo finitura Titanio opaco oppure Nichel Nero lucido.

Console composed of a 23 mm DV Glass top, available in transparent or in colored striped glass. Metal base available in opaque Titanium or in Black Glossy Nickel finishes.

Console avec plateau en DV Glass de 23 mm transparent ou avec bandes colorées. Base en métal finition Titane opaque ou Nickel noir brillant.

Konsole mit Platte aus DV Glass, Stärke 23mm in der Ausführung Transparent oder mit farbigen Streifen erhältlich. Untergestell aus Metall in den Farbvarianten matt Titan oder glanz Schwarz Nickel.

120 x 45 x 75 cm  
47 1/4" x 17 1/16" x 29 1/2"

150 x 45 x 75 cm  
59" x 17 1/16" x 29 1/2"

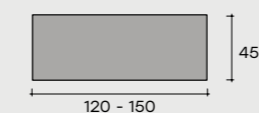
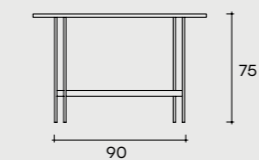

**Struttura**  
Structure

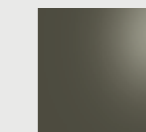

titanio opaco  
opaque titanium

**Piano in DV-Glass**  
DV-Glass top

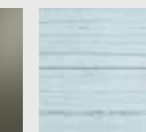

vetro fuso trasparente  
fused transparent glass

**Struttura**  
Structure

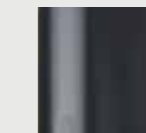

nichel nero lucido  
black glossy nickel

**Piano in DV-Glass**  
DV-Glass top

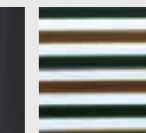

vetro fuso colorato  
fused colored glass



# bacall

DESIGN  
THIS WEBER

Sedia rivestita in cuoio con struttura interna in tubolare metallico e legno. Disponibile nei colori: bianco, nero, testa di moro e grigio cenere.

Leather upholstered chair with internal structure in tubular metal and wood. Available in the following colours: white, black, dark brown and ash grey.

Chaise recouverte en cuir avec structure interne en tube métallique et bois. Disponible dans les coloris: blanc, noir, marron et gris cendré.

Stuhl mit Lederbezug und Innenstruktur aus Metall- und Holzrohren. Verfügbar in den Farben: Weiß, Schwarz, Dunkelbraun und Aschgrau.

46 x 52 x 83 cm  
18 1/8" x 20 1/2" x 32 11/16"

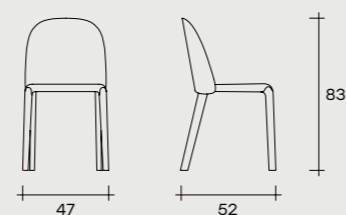

testa di moro U41 dark brown U41  
grigio cenere U18 ash grey U18  
bianco U05 white U05  
nero U04 black U04

# brigitte

DESIGN  
FABIO DI BARTOLOMEI

Sedia a schienale alto rivestita in pelle con struttura interna in tubolare metallico e legno. Disponibile nei colori: bianco, nero e marrone.

High-back chair leather upholstered, with tubular metal and wood internal structure. Available in white, black and brown.

Chaise à dossier haut recouvert en cuir avec structure interne en tube de métal et bois. Disponible dans les coloris : blanc, noir et marron.

Hochlehner mit Kunstleder-Verkleidung und Innenstruktur aus Metallrohren und Holz. In den Farben Weiß, Schwarz und Braun.

48 x 60 x 104 cm  
18 7/8" x 23 5/8" x 41"

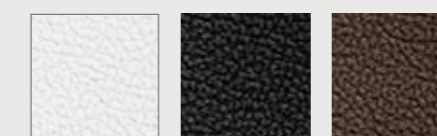
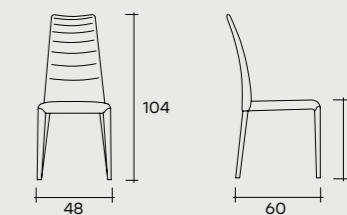

bianco F05 white F05  
nero F04 black F04  
testa di moro F41 Dark brown F41

# callas

DESIGN  
THIS WEBER

Sedia rivestita in cuoio con struttura interna in tubolare metallico. Disponibile nei colori: testa di moro, grigio cenere, bianco, nero.

Leather-upholstered chair with internal structure in tubular metal. Available in dark brown, grey ash-colour, white, black.

Chaise recouverte de cuir avec une structure interne en tube métallique. Disponible dans les coloris: marron, gris cendrex, blanc, noir.

Stuhl mit Lederbezug und Innenstruktur aus Metallrohren. Lieferbar in den Farben Dunkelbrown, Aschgrau, Weiß, Schwarz.

48 x 58 x 85 cm  
18 7/8" x 22 13/16" x 33 7/16"

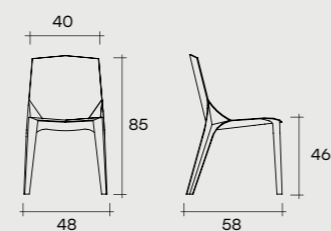

testa di moro U41 dark brown U41  
grigio cenere U18 ash grey U18  
bianco U05 white U05  
nero U04 black U04

# dress

DESIGN  
ARCHIRIVOLTO

Sedia rivestita in cuoio con struttura interna in tubolare metallico e legno. Disponibile nei colori tinta unita standard bianco, marrone, nero, colori a richiesta su cartella colori. Disponibili anche in cuoio bicolore a scelta sulla cartella colori. Non impilabile.

Leather-upholstered chair with internal structure in tubular metal and wood. Available in the standard whole colours white, brown and black, and with custom colours from colour chart. Also available in two custom colours chosen from the colour chart. Not stacking.

Chaise revêtue en cuir avec structure interne en tube métallique et bois. Disponible dans les coloris teinte unie standard blanc, marron, noir, coloris sur demande sur carte des coloris. Egalement disponible en cuir bicolore au choix sur carte des coloris.

Stuhl mit Lederbezug und Innenstruktur aus Metallrohren und Holz. Lieferbar in den Farben Uni Standard Weiß, Braun, Schwarz, auf Anfrage auch in den Farben der Farbkarte, sowie mit zweifärbigem Lederbezug nach Wahl aus der Farbkarte.

43 x 49 x 86,5 cm  
16 15/16" x 19 5/16" x 34 1/16"

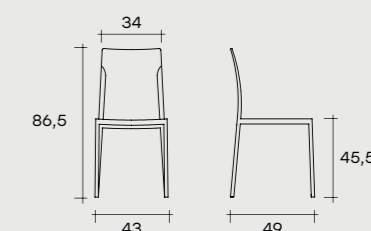

bianco U05 white U05  
nero U04 black U04  
caffè U25 coffee U25  
bicolor

# easy lloyd

DESIGN  
STUDIO KLASS

Sedia con struttura in legno massello disponibile nelle finiture rovere tabacco o laccato nero a poro aperto. Seduta e schienale rivestiti in pelle.

Chair with solid wood structure, available in oak tobacco, or in open pore glossy black painted finishes. Seat and backrest are leather-upholstered.

Chaise avec structure en bois massif disponible dans les finitions chêne tabac ou laqué noir à pore ouvert. Assise et dossier revêtus en cuir.

Stuhl mit Struktur aus massiven Holz in den folgenden Ausführungen: Eiche Tabak oder offenporig schwarz lackiert. Sitzfläche und Rücklehne mit Lederbezug.

47 x 57 x 78 cm  
18 1/2" x 22 7/16" x 30 1/16"

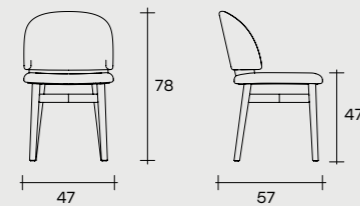

**Struttura in legno**  
Wood structure

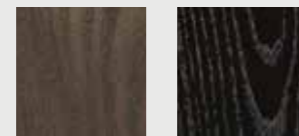

finitura rovere tabacco  
tobacco oak finish

laccato nero poro aperto  
open pore black finish

**Rivestimento in pelle**  
Leather upholstery

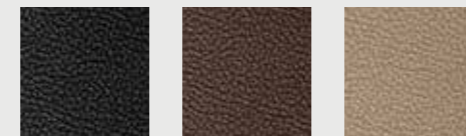

nero F04  
black F04

testa di moro F41  
dark brown F41

fumo F20  
smoke F20

# kamy

DESIGN  
SETSU E SHINOBU ITO

Sedia impilabile rivestita completamente in pelle sfoderabile. Struttura in tubolare metallico schiumato con gomme poliuretaniche espande. Disponibile nei colori: bianco, nero e marrone.

Stacking chair with removable leather upholstery. Tubular metal structure with expanded polyurethane rubber foam. Available in white, black and brown.

Chaise empilable entièrement recouverte de cuir déhoussable. Structure en tube métallique rempli de caoutchouc de polyuréthane expansé. Disponible dans les couleurs : blanc, noir et marron.

Stapelbarer Stuhl mit abziehbarer Lederhülle. Mit PUR ausgeschäumte Metallrohrstruktur. Lieferbar in den Farben Weiß, Schwarz und Braun.

46 x 53 x 82 cm  
18 1/8" x 20 7/8" x 32 5/16"

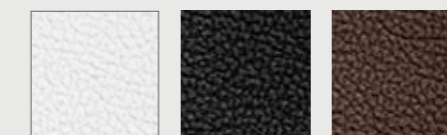
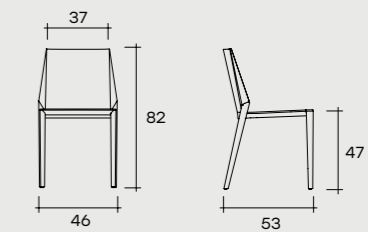

bianco F05  
white F05

nero F04  
black F04

testa di moro F41  
dark brown F41

lloyd

DESIGN  
STUDIO KLASS

Sedia con struttura in legno massello disponibile nelle finiture rovere tabacco o laccato nero a poro aperto. Seduta e schienale rivestiti in pelle.

Chair with solid wood structure, available in tobacco oak or in open pore black laquered finishes. Seat and backrest are leather-upholstered.

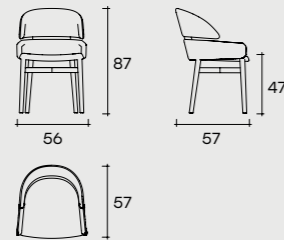

Chaise avec structure en bois massif disponible dans les finitions chêne tabac ou laqué noir à pore ouvert. Assise et dossier revêtus en cuir.

Stuhl mit Struktur aus massiven Holz in den folgenden Ausführungen: Eiche Tabak oder offenporig schwarz lackiert. Sitzfläche und Rücklehne mit Lederbezug.

46 x 53 x 82 cm  
18 1/8" x 20 7/8" x 32 5/16"



**Struttura in legno**  
Wood structure



finitura rovere tabacco  
tobacco oak finish

laccato nero poro aperto  
open pore black finish

**Rivestimento in pelle**  
Leather upholstery

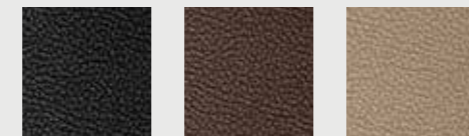

nero F04  
black F04

testa di moro F41  
dark brown F41

fumo F20  
smoke F20

magma

DESIGN  
PATRICK JOUIN

Sedia con struttura in legno massello disponibile nelle finiture rovere naturale o tinto grigio. Seduta e schienale rivestiti in pelle.

Chair with solid wood structure, available in natural or grey oak finish. Seat and backrest are leather-upholstered.

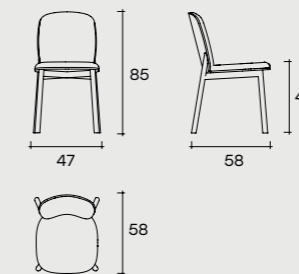

Chaise avec structure en bois massif disponible dans les finitions chêne naturel ou de couleur grise. Assise et dossier revêtus en cuir.

Stuhl mit Struktur aus massiven Holz in den folgenden Ausführungen: Eiche Natur oder grau lackiert. Sitzfläche und Rücklehne mit Lederbezug.

L 47 P 58 H 85 cm  
W 18 1/2" D 22 13/16" H 33 7/16"



**Struttura in legno**  
Wood structure

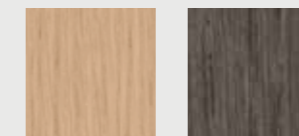

finitura rovere naturale  
natural oak finish

finitura rovere tinto grigio  
grey oak finish

**Rivestimento in pelle**  
Leather upholstery



bianco F05  
white F05

nero F04  
black F04

testa di moro F41  
dark brown F41

fumo F20  
smoke F20

# plié

DESIGN  
STUDIO KLASS

Sedia rivestita in cuoio e pelle con struttura interna in tubolare metallico e legno.

Leather-upholstered chair with internal structure in tubular metal and wood.

Chaise recouverte en cuir avec structure interne en tube métallique et bois.

Stuhl mit Lederbezug und Innenstruktur aus Metall- und Holzrohren.

52 x 50 x 79 cm  
20 1/2" x 19 1/16" x 31 1/8"

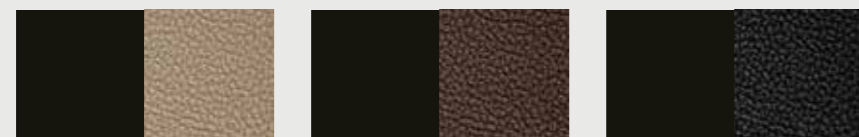
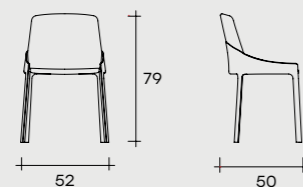

nero U04 fumo F20  
black U04 smoke F20

nero U04 testa di moro F41  
black U04 dark brown F41

nero U04 nero F04  
black U04 black F04



testa di moro U41 nero F04  
dark brown U41 black F04

testa di moro U41 testa di moro F41  
dark brown U41 dark brown F41

testa di moro U41 fumo F20  
dark brown U41 smoke F20

## pelle leather

DI SERIE \_ STANDARD

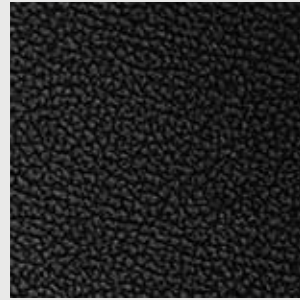

**F04**  
Pelle nera  
Leather black



**F05**  
Pelle bianca  
Leather white

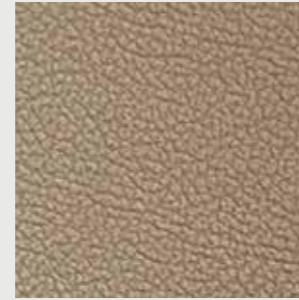

**F20**  
Pelle fumo  
Leather smoke

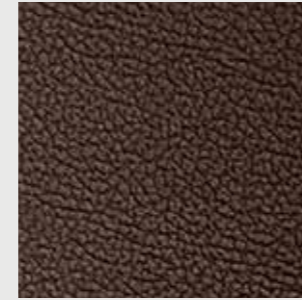

**F41**  
Pelle testa di moro  
Leather dark brown

## cuoio hide

DI SERIE \_ STANDARD

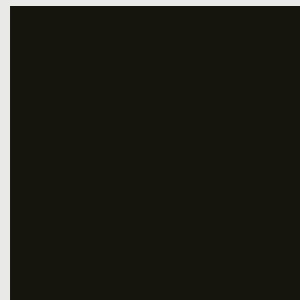

**U04**  
Cuoio nero  
Hide black

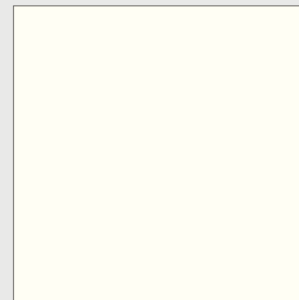

**U05**  
Cuoio bianco  
Hide white

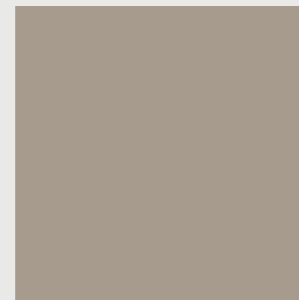

**U18**  
Cuoio grigio cenere  
Hide ash grey

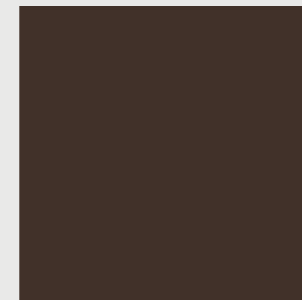

**U25**  
Cuoio caffè  
Hide coffee

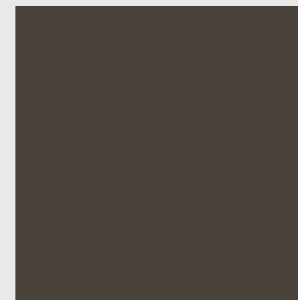

**U41**  
Cuoio testa di moro  
Hide dark brown

## cuoio hide

SU RICHIESTA \_ ON REQUEST



**U01**  
Cuoio rosso bulgaro  
Hide red bulgaro



**U02**  
Cuoio grigio scuro  
Hide dark grey



**U21**  
Cuoio arancio  
Hide orange

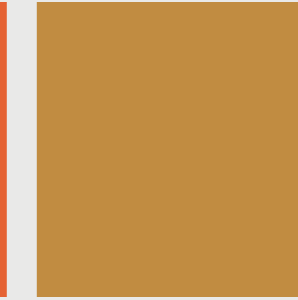

**U21**  
Cuoio ocre  
Hide ocher



**U34**  
Cuoio vaniglia  
Hide vanilla



**U42**  
Cuoio rosso  
Hide red



**U53**  
Cuoio avana  
Hide havana

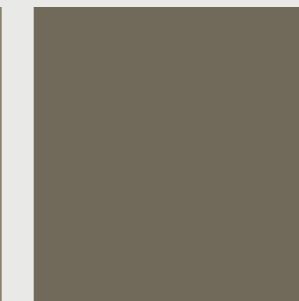

**U54**  
Cuoio fango  
Hide fango

vetro trasparente  
transparent glass

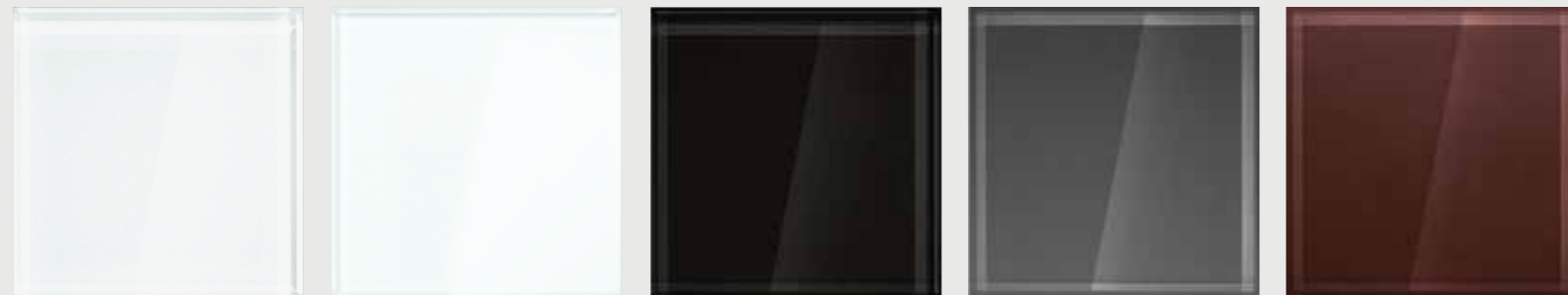

**V1**  
Vetro trasparente  
Transparent glass

**V2**  
Vetro trasparente acidato  
Etched glass

**V4**  
Vetro trasparente  
retroverniciato nero  
Black back-painted glass

**V-GR**  
Vetro trasparente  
retroverniciato  
grigio grafite  
Graphite grey  
back-painted glass

**V-VI**  
Vetro trasparente  
retroverniciato  
rosso vinaccia  
Wine red  
back-painted glass

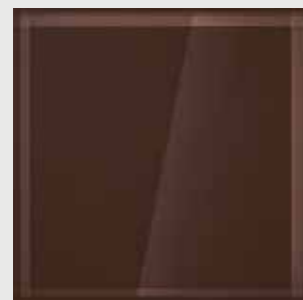

**V-MR**  
Vetro trasparente  
retroverniciato testa di moro  
Dark brown  
back-painted glass

vetro extralight  
extralight glass

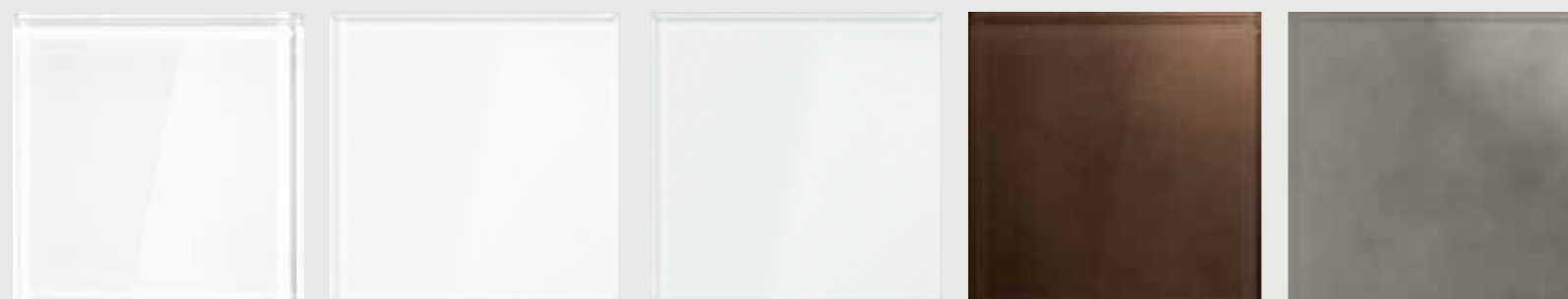

**VX1**  
Vetro extralight  
Extralight glass

**VX2**  
Vetro extralight acidato  
Etched extralight glass

**VX3**  
Vetro extralight acidato  
retroverniciato bianco  
White back-painted and  
etched extralight glass

**VXA-MN**  
Vetro extralight  
acidato retroverniciato  
Marrone Nuvolato  
Cloudy Brown back-painted  
and etched extralight glass

**VXA-PS**  
Vetro extralight acidato  
retroverniciato Piombo Satinato  
Glazed Lead back-painted  
and etched extralight glass

vetro fuso  
fused glasse



**V6**  
Vetro trasparente fuso  
retroverniciato fumo  
Back-painted fused glass,  
smoke finish

**V7**  
Vetro trasparente fuso  
retroverniciato ambra  
Back-painted fused glass,  
amber finish

**V8**  
Vetro trasparente fuso  
retroverniciato blu  
Back-painted fused glass,  
blue finish

**V9**  
Vetro trasparente fuso  
retroverniciato naturale  
effetto satinato  
Back-painted fused glass,  
natural satin finish

**VFGO-RO**  
Vetro trasparente fuso  
retroverniciato Rosa Antico  
Antique Rose finish



**VFCA**  
Vetro trasparente fuso  
con texture Cannage  
Transparent fused glass,  
with Cannage texture



**VFCEB**  
Vetro trasparente fuso  
con texture Coral Beach  
Transparent fused glass,  
with Coral Beach texture

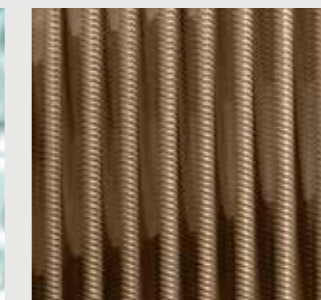

**VBFR**  
Vetro bronzo fuso  
con texture a righe  
Fused bronze glass  
with striped texture

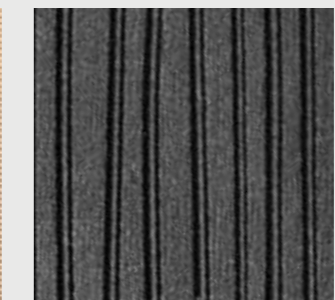

**VF-LA**  
Vetro trasparente fuso  
retroverniciato Grigio Lava  
Back-painted fused glass,  
Lava Grey finish

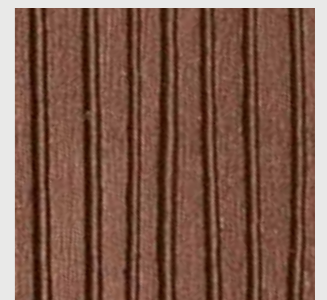

**VF-RA**  
Vetro trasparente fuso  
retroverniciato Marrone Ramato  
Back-painted fused glass,  
Copper Brown finish

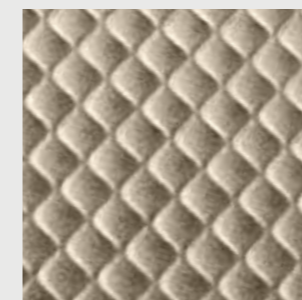

**VFLU-CH**  
Vetro trasparente fuso  
retroverniciato Champagne  
Back-painted fused glass,  
Champagne finish



**VF-MM**  
Vetro trasparente  
fuso retroverniciato  
Marrone Metallizzato  
Back-painted fused glass,  
Metallic Brown finish

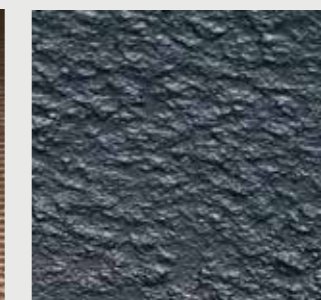

**VFLK-BL**  
Vetro trasparente fuso  
retroverniciato Blu Notte  
Back-painted fused glass,  
Night Blue finish



**VFMC**  
Vetro fuso Multicolor  
Multicolor fused glass



**DV-TR23**  
DV-Glass® trasparente  
spessore 23 mm  
Transparent DV-Glass®  
23 mm thick



**DV-CO30**  
DV-Glass® colorato  
spessore 30 mm  
Colored DV-Glass®  
30 mm thick

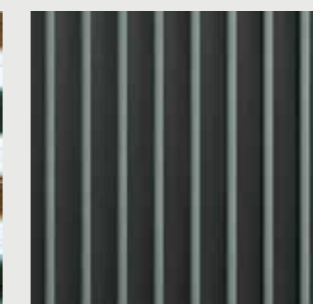

**DV-FU30**  
DV-Glass® a strisce  
fumé e trasparenti  
DV-Glass® with smoked  
and transparent stripes

# materiali materials

## altri vetri other glasses



**AV1**  
Vetro fumé  
Smoked glass

**AV2**  
Vetro bronzo  
Bronze glass

**AV3**  
Vetro Nero95  
Black95 glass

**AV6**  
Vetro bianco opale  
Opal glass

**AV8**  
Vetro fumé  
retroargentato  
Back-silvered  
smoked glass

## Ecomalta®



**TBP**  
Avorio  
Ivory

**TNR**  
Tortora  
Dove grey

**MNA**  
Nero Ardesia  
Black Slate

**MAR**  
Argilla  
Clay Brown

**M25**  
Fango  
Mud Brown



**M42**  
Calce  
Lime Grey

## legno wood

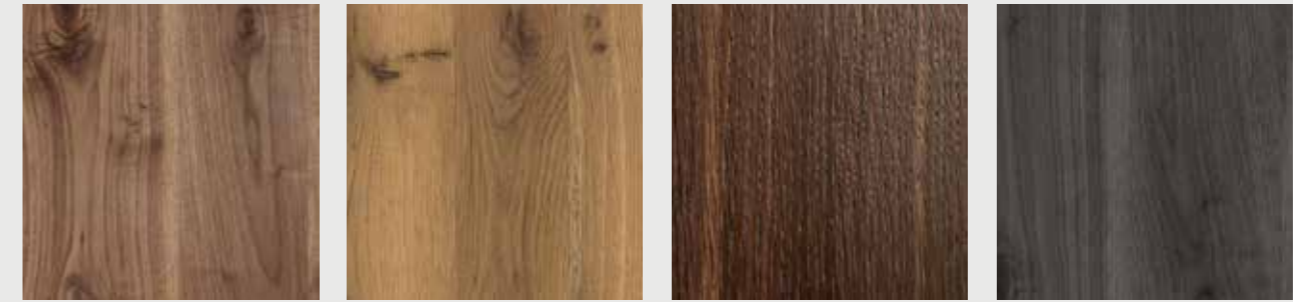

**L7**  
Noce canaletto  
Canaletto walnut

**L8**  
Rovere "old"  
"Old style" oak

**L9**  
Rovere termotrattato  
Heat-treated oak

**L11**  
Noce canaletto finitura  
Antracite Opaco  
Canaletto walnut,  
matt anthracite finish

## metallo metal



**MET-TB**  
Terra bruciata  
Burned earth

**MET-GP**  
Grigio Platino  
Platinum grey

**MET-NI**  
Nichel nero lucido  
Black glossy Nickel

**MET-TI**  
Titanio opaco  
Opaque Titanium

**MET-LA**  
Grigio lava  
Lava grey

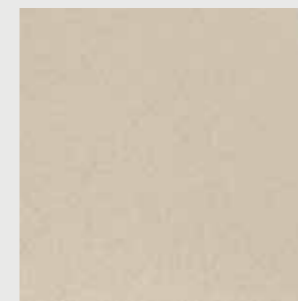

**MET-CH**  
Champagne metallizzato  
Metallic Champagne





## FIAM, garanzia di qualità

FIAM è certificata UNI EN ISO 9001:2008; la conformità a questa norma di riferimento permette a FIAM di raggiungere altissimi standard qualitativi. Una delle testimonianze dirette è la rintracciabilità dei suoi manufatti: ogni prodotto FIAM reca una decalcomania indelebile, cotta ad altissima temperatura, nella quale viene riportato oltre al marchio aziendale, un codice che permette di ricostruire il suo intero ciclo produttivo.

## FIAM, garantie de qualité

FIAM est une entreprise certifiée UNI EN ISO 9001:2008; la conformité à cette norme de référence permet à FIAM d'atteindre des niveaux de qualité très élevés. La traçabilité des produits en est une preuve: chaque produit FIAM porte une décalcomanie indélébile, cuite à très haute température, qui mentionne la marque de l'entreprise et un code permettant de reconstruire tout son cycle de production.

## FIAM, garantee of quality

Fiam is certified UNI EN ISO 9001:2008; the conformity to this reference norm allows Fiam to reach the highest quality standards. One of the direct evidences is the possibility to track of the products: a high temperature and therefore indelible decal is applied to every article, in addition to the company logo, this decal also bears a number of codes that allow the production cycle details of the article to be traced.

## FIAM, eine Qualitätsgarantie

FIAM ist nach UNI EN ISO 9001:2008 zertifiziert und garantiert damit für höchste Qualitätsstandards. Dazu gehört auch die Nachverfolgbarkeit des Entstehungsweges der Erzeugnisse: Jedes FIAM-Produkt wird mit einem bei hohen Temperaturen eingebrannten Abziehbild versehen, auf dem neben dem Markenzeichen des Herstellers eine Identifikationsnummer steht, anhand der sich der gesamte Produktionszyklus des Artikels nachverfolgen lässt.

## La garanzia del risultato: il controllo qualità.

Guaranteed flawless standards: quality control.  
La garantie du résultat: le contrôle qualité.  
Die Garantie für das Resultat – die Qualitätskontrolle.



**art direction**

**copywriting**  
acanto comunicazione  
(carlo piazzesi)

**graphic design and layout**

acanto comunicazione

**rendering images**

acanto comunicazione

**photography and postproduction**

studio amatibacciardi  
studio leon

**styling**

monti studio  
candida zanelli and serenella parri  
conti | marchetti studio

**marketing project**

daniele livi

**coordination and logistics**

lorenzo marzoli

**selections**

olimpia visual plan

**print and packaging**

grapho 5

september 2019

Fiam Italia  
Via Ancona 1/b  
61010 Tavullia (PU), Italia  
Tel. 0039 0721 20051  
Fax: 0039 0721 202432

[www.fiamitalia.it](http://www.fiamitalia.it)  
[info@fiamitalia.it](mailto:info@fiamitalia.it)

**credits**

ALESSI  
ALFRED DRAGO RENS - GALLERIA L'AFFICHE  
AMINI CARPET  
ANTONINO SCIORTINO  
APPLE  
ARFLEX  
ARTEK  
ATELIER POLYHEDRE  
AXIL  
AYTM  
BAXTER  
BOFFI  
BONACINA 1889  
BPA INTERNATIONAL  
BUSNELLI di Gruppo Industriale Busnelli  
CAPPELLINI  
CARPET EDITION  
CECILIA MARINO  
CERAMICHE ARTISTICHE BOTTEGA VIGNOLI  
CINOVA di Gruppo Industriale Busnelli  
COHEN SEDGH TAPPETI  
COOEE DESIGN  
CORAXART  
D3CO  
DAVIDE LOVATTI  
DEDAR  
DE PADOVA  
DESALTO  
EDD  
ENTRATA LIBERA  
FELIS  
FINN FORM PER ITTALA  
FLOS  
FLOU  
FONTANAARTE  
GALLERIA ARTRA MILANO  
GOLRAN  
HK LIVING  
IL FANALE GROUP  
INCIPITLAB  
JAB  
KASTHALL  
LES OTTOMANS  
LIVING DIVANI  
LUCEPLAN  
MARINO CRISTAL  
MARTA FULVI  
MARTINELLI LUCE  
MATI  
MATTIAZZI  
MODO LUCE  
MOROSO  
MY HOME COLLECTION  
NANIMARQUINA  
OLUCE  
ORIZZONTI  
PIANCA E OTTOEMEZZO  
POLIFORM  
RAW  
RATTI BOUTIQUE  
REZINA  
RINA MENARDI  
ROMAGNOLI ARREDAMENTI PESARO  
ROSENTHAL  
SALVIATI  
SAMBONET  
SANTA & COLE  
SCANDOLA MARMI  
SERVOMUTO  
SFORZIN ILLUMINAZIONE  
SILVA TESSUTI  
TATO ITALIA  
TOOY  
VERY WOOD  
VITRA



Compasso d'Oro  
alla carriera

LEO  
NAR  
DO

Premio Leonardo  
Qualità Italia 2015



fiamitalia.it

