

Reportage23



 **FIAM**

Milano, Salone del Mobile 2023



A story. The tale of an evolution. The world seen through the purest essence of our glass and fusions we tell it today in a different manner.

More self-aware. More articulate. More complete.

We work on materials, juxtapositions, signs, and atmospheres to create environments in which our products dialogue in unison.

Un percorso. Raccontiamo la nostra storia, una storia in cui il vetro è il fil rouge che lega le nostre emozioni, i nostri prodotti e i nostri ambienti.

Il progetto Mood ci ha permesso di dare un nuovo corpo al nostro lavoro, una nuova prospettiva. Ci confrontiamo con sensazioni di comfort differenti che traduciamo non più "solo" in prodotti, ma in oggetti la cui anima dialoga con il resto dell'arredo e con l'architettura in cui sono inseriti.

Nella progettazione utilizziamo materie, segni, accostamenti che permettono ai nostri vetri e alle nostre fusioni di esprimere la loro bellezza e il loro valore in maniera sobria e raffinata, in accostamento agli altri materiali presenti in gamma.

Nuances, percezioni e sensazioni per assaporare il comfort e la piacevolezza del vivere i nostri ambienti.

Una gamma che con la Collezione 23 si arricchisce di nuovi elementi che permettono di risolvere ulteriori esigenze abitative, tutte interpretate in chiave FIAM.

A journey. We narrate our story, a story in which glass is the common thread linking our emotions, our products and our ambiances.

The Mood project has given new life to our work, a new perspective. We are now able to offer different sensations of comfort that result no longer 'only' in products, but also in objects whose soul dialogues with the rest of the furnishing and the architecture they are placed in.

When designing we use different materials, patterns and combinations that allow our glass and fusions to express their beauty and value in a sober and refined manner, while still interacting with the other materials in the range.

Nuances, perceptions and sensations merge in our ambiances and can be savored in their atmosphere deeply marked comfort and pleasantness.

With the 23 Collection, the range gets enriched with new elements that make it possible to fulfil further housing needs, all interpreted in a FIAM key.

Un voyage. Nous racontons notre histoire, une histoire dans laquelle le verre est le fil conducteur qui relie nos émotions, nos produits et nos environnements.

Le projet Mood nous a permis de donner un nouveau corps à notre travail, une nouvelle perspective. Nous sommes confrontés à différentes sensations de confort que nous ne traduisons plus "seulement" en produits, mais en objets dont l'âme dialogue avec le reste du mobilier et l'architecture dans laquelle ils sont insérés.

Dans la conception, nous utilisons des matériaux, des signes, des combinaisons qui permettent à nos verres et à nos fusions d'exprimer leur beauté et leur valeur de manière sobre et raffinée, en association avec les autres matériaux de la gamme.

Nuances, perceptions et sensations pour savourer le confort et l'agrément de vivre nos environnements.

Une gamme qui, avec la Collection 23, s'enrichit de nouveaux éléments qui permettent de résoudre des besoins supplémentaires de l'habitat, le tout interprété dans une clé FIAM.

Eine Reise. Wir erzählen unsere Geschichte, eine Geschichte, in der Glas der rote Faden ist, der unsere Emotionen, unsere Produkte und unsere Umgebung verbindet.

Das Projekt Mood hat unserer Arbeit neues Leben eingehaucht, eine neue Perspektive eröffnet. Wir konfrontieren uns mit verschiedenen Komfortgefühlen, die wir nicht mehr "nur" in Produkte umsetzen, sondern in Objekte, deren Seele mit dem Rest der Einrichtung und der Architektur, in der sie platziert werden, in Dialog tritt.

Bei der Gestaltung verwenden wir Materialien, Muster und Kombinationen, die es unseren Gläsern und Fusionen ermöglichen, ihre Schönheit und ihren Wert auf nüchterne und raffinierte Weise auszudrücken, in Kombination mit den anderen Materialien der Produktpalette.

Nuances, Wahrnehmungen und Empfindungen verschmelzen in unseren Räumen und schaffen eine Atmosphäre von Komfort und Wohlbefinden.

Mit der Kollektion 23 wird den Sortiment um neue Elemente bereichert, die es ermöglichen, weitere Wohnbedürfnisse zu erfüllen, die alle in der FIAM-Schlüssel interpretiert sind.



FIAM

FIAM

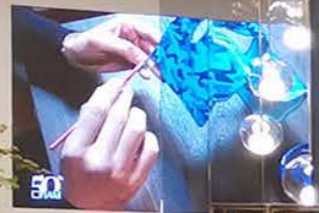

FIAM



FIAM

OFIAM





FIAM





flaminio

design Studio Klass

Flaminio nasce dalla volontà di valorizzare la leggerezza e l'armonia di un oggetto protagonista in molteplici momenti del nostro quotidiano. In riferimento all'omonimo stadio romano progettato da Pier Luigi Nervi, questo tavolo gioca di contrasti tra pieni e vuoti, valorizzando la lavorazione del vetro in relazione alla struttura in essenza. Il top del tavolo è sorretto ed incorniciato dal telaio che, grazie all'inedita sezione, divide il piano dalla base, ritrovando la stessa leggerezza che contraddistingue le opere di Nervi. A sottolineare questa interruzione, la scelta di due materiali in purezza: la fluidità del vetro e la solidità del legno.

Flaminio arose from the desire to enhance the lightness and harmony of an object which is a protagonist of multiple moments of our everyday life. Inspired to the homonymous stadium in Rome designed by Pier Luigi Nervi, this table plays with contrasts between full and empty spaces, highlighting the glass manufacturing in relation to its relevant real wooden structure. The table top is supported and surrounded by a frame that divides it from the relevant base through an unusual section, rediscovering the same lightness that distinguishes Nervi's works. This interruption is highlighted by the choice of two pure materials: glass and its fluidity combined to the robustness of wood.

Flaminio est née du désir de mettre en valeur la légèreté et l'harmonie d'un objet qui joue un rôle prépondérant dans de nombreux moments de notre vie quotidienne. En référence au stade romain du même nom conçu par Pier Luigi Nervi, cette table joue sur les contrastes entre les pleins et les vides, en mettant en valeur le travail du verre par rapport à la structure en bois. Le plateau de la table est soutenu et encadré par le cadre qui, grâce à sa section inhabituelle, sépare le plateau de la base, retrouvant ainsi la même légèreté qui distingue les œuvres de Nervi. Cette interruption est soulignée par le choix de deux matériaux purs : la fluidité du verre et la solidité du bois.

Flaminio entstand aus dem Wunsch, die Leichtigkeit und Harmonie eines Objekts zu unterstreichen, das in vielen Momenten unseres täglichen Lebens eine Hauptrolle spielt. Inspiriert von dem gleichnamigen Stadion in Rom, das von Pier Luigi Nervi entworfen wurde, spielt dieser Tisch mit den Kontrasten zwischen vollem und leerem Raum und hebt die Arbeit des Glases gegenüber der Holzstruktur hervor. Die Tischplatte wird von dem Rahmen gestützt und eingerahmt, der durch seinen ungewöhnlichen Querschnitt die Platte vom Unterbau trennt und so die gleiche Leichtigkeit wiederfindet, die Nervi's Werke auszeichnet. Diese Unterbrechung wird durch die Wahl von zwei reinen Materialien hervorgehoben: die Fließfähigkeit des Glases und die Festigkeit des Holzes.





Tobacco finish wood base,
Fused and back-painted glass top,
Brilliant Brown finish.
300 x 110 x H75 cm



Black finish wood base,
Fused and back-painted glass top,
Brilliant Black finish.
300 x 110 x H75 cm

cristaline

design Marcel Wanders studio

La collezione Cristaline, creata da Marcel Wanders, è completata da un gruppo di tavolini e da una consolle. Sperimentando l'esclusiva tecnica artigianale della fusione e della formatura del vetro in lastra propria del marchio FIAM, questa collezione incarna grazia e bellezza per creare un pattern superficiale che esemplifica la geometria e la natura attraverso un complesso motivo floreale. Traendo ispirazione dal tradizionale bouquet in vaso per la tavola, questo motivo sostituisce i fiori naturali ad eterne incisioni di fiori trasparenti e cristallizzati su ogni tavolo. Accogliendo per sempre la bellezza organica e la natura in casa.

The Cristaline collection designed by Marcel Wanders studio, expands with a group of coffee tables and a console. This collection expresses subtle beauty and grace creating an intricate superficial texture that exemplifies geometry and nature through a decorative floral pattern; a tangible output of the constant experimentation in the field of glass fusing and manufacturing conducted by the Brand FIAM with its unique technologies. Drawing inspiration from the traditional center table bouquet, this pattern substitutes natural flowers with eternal engravings of transparent, crystalized flowers on every table welcoming organic beauty and nature.

La collection Cristaline, créée par Marcel Wanders, est complétée par un groupe de tables basses et une console. Cette collection illustre la beauté subtile et la grâce en expérimentant la technologie unique de fusion et de courbure du verre, maîtrisée par la marque d'artisanat verrier FIAM, pour créer un motif complexe et superficiel qui illustre la géométrie et la nature à travers un motif floral complexe. En s'inspirant du traditionnel bouquet dans un vase, ce motif remplace les fleurs naturelles par des gravures éternelles de fleurs transparentes et cristallisées sur chaque table. La beauté organique et la nature s'invitent à jamais dans la maison.

Die vom Studio Marcel Wanders entworfene Kollektion Cristaline wird durch eine Gruppe von Couchtischen und eine Konsole erweitert. Diese Kollektion drückt subtile Schönheit und Anmut aus, indem sie eine komplizierte Oberflächenstruktur schafft, die Geometrie und Natur durch ein dekoratives Blumenmuster veranschaulicht; ein greifbares Ergebnis der ständigen Experimente im Bereich der Glasverschmelzung und -herstellung, die von der Marke FIAM mit ihren einzigartigen Technologien durchgeführt werden. In Anlehnung an den traditionellen Blumenstrauß in einer Vase ersetzt dieses Muster die natürlichen Blumen durch ewige Gravuren von transparenten und kristallisierten Blumen auf jedem Tisch. Organische Schönheit und die Natur ziehen für immer in Ihr Zuhause ein.





Opaque Titanium finish metal base;
fused and back-painted glass top,
Brilliant Black finish.
147 x 48 x H75 cm



Opaque Titanium finish metal base,
fused and back-painted glass top,
Brilliant Brown finish.
147 x 48 x H75 cm



Black Glossy Nichel finish metal base,
fused extralight glass top,
Manhattan marble top.
147 x 48 x H75 cm







remind

design Simone Bonanni

Mi piace pensare alla libreria come ad una vetrina di passioni e ricordi felici. Un'esposizione di oggetti, fotografie e libri che in qualche modo ci rappresentano e che ogni tanto abbiamo il piacere di consultare, condividendoli inevitabilmente con gli ospiti. La libreria di oggi, non è più solo una quinta attrezzata, ma si è trasformata in espressione di noi stessi e di come desideriamo essere percepiti. Per Fiam ho disegnato Remind, con l'idea di creare un sistema modulare terra-cielo che riuscisse a mettere in risalto l'immagine di noi stessi, un oggetto capace di andare oltre all'aspetto puramente funzionale e che attraverso il vetro, potesse carpire una luce nuova, staccandosi dallo sfondo della scena domestica per conquistare un ruolo da protagonista.

I like to think of the bookshelf as a showcase of passions and pleasant memories. As an exhibition of objects, photographs and books that somehow represent us and that we occasionally have the pleasure of consulting, inevitably sharing them with our guests. The contemporary bookcase is no longer just an equipped backdrop, having turned into an expression of ourselves and how we want to be perceived. Hence I designed for FIAM "Remind", with the idea of creating a floor-to-ceiling modular system that could highlight the image of ourselves, an object capable of going beyond the purely functional aspect and capturing a new light through the presence of glass, breaking away from the background of the domestic scene to while gaining the spot light.

J'aime considérer la librairie comme une vitrine de nos passions et de nos bons souvenirs. Un étalage d'objets, de photographies et de livres qui nous représentent d'une certaine manière et que nous avons parfois le plaisir de consulter et, inévitablement, de partager avec nos hôtes. La bibliothèque d'aujourd'hui n'est plus seulement une toile de fond équipée, mais elle est devenue l'expression de nous-mêmes et de la façon dont nous souhaitons être perçus. J'ai conçu Remind pour Fiam, avec l'idée de créer un système modulaire du sol au plafond qui puisse mettre en valeur l'image de nous-mêmes, un objet capable d'aller au-delà de l'aspect purement fonctionnel et qui, à travers le verre, puisse recevoir une nouvelle lumière, se détachant de l'arrière-plan de la scène domestique pour jouer un rôle de premier plan.

Ich stelle mir das Bücherregal gerne als ein Schaufenster der Leidenschaften und schönen Erinnerungen vor. Als eine Ausstellung von Objekten, Fotos und Büchern, die uns irgendwie repräsentieren und die wir gelegentlich mit Vergnügen konsultieren und unweigerlich mit unseren Gästen teilen. Das zeitgenössische Bücherregal ist nicht mehr nur ein eingerichteter Hintergrund, es ist zu einem Ausdruck unserer selbst geworden und dessen, wie wir wahrgenommen werden wollen. Daher habe ich für FIAM "Remind" entworfen, mit der Idee, ein raumhohes modulares System zu schaffen, das das Bild von uns selbst hervorheben kann, ein Objekt, das über den rein funktionalen Aspekt hinausgeht und durch die Präsenz von Glas ein neues Licht einfängt, das aus dem Hintergrund der häuslichen Szene heraustritt und ins Rampenlicht rückt.

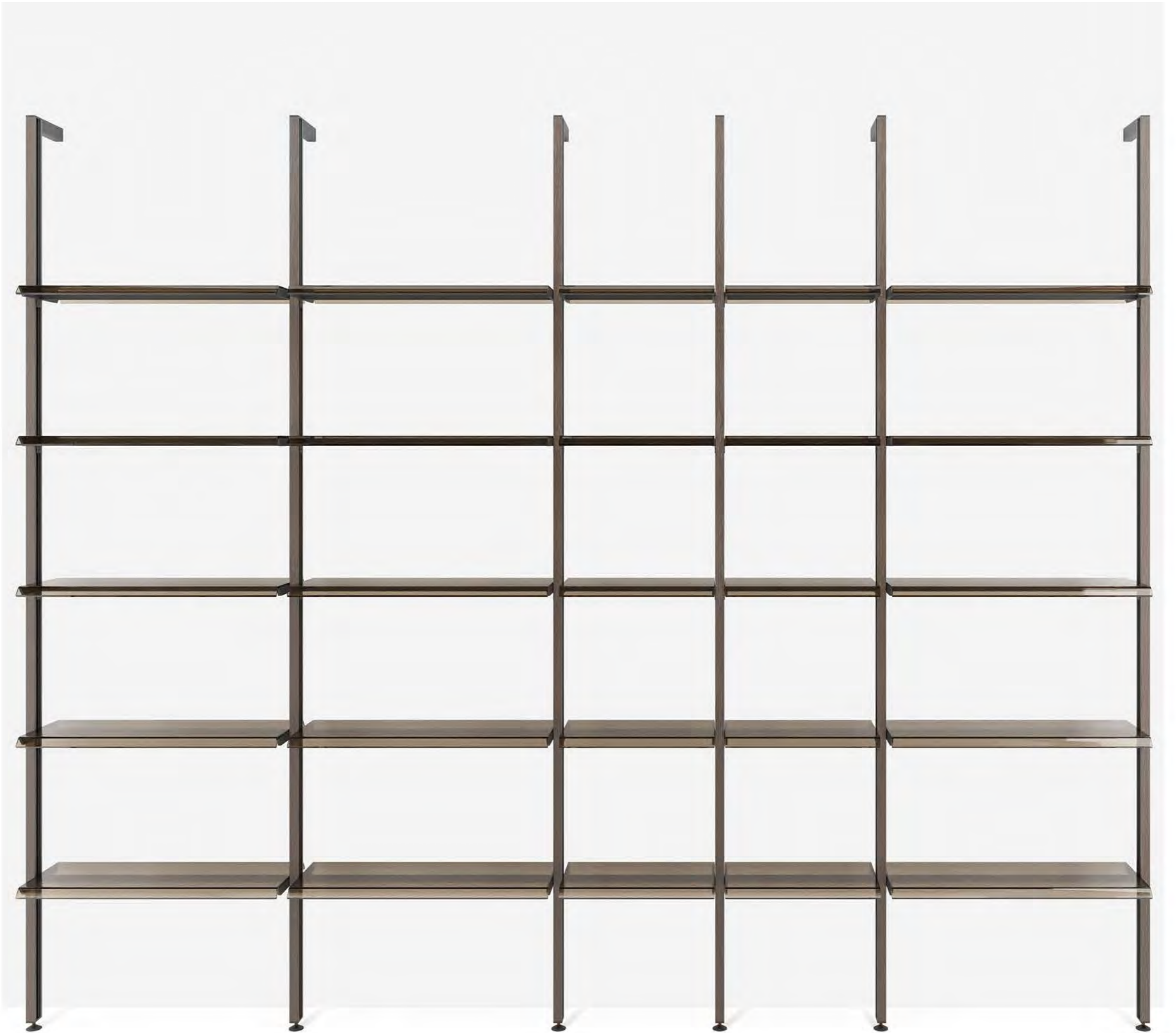

Uprights with Tobacco finish wood molding;
fused bronze glass shelves.

COMP-6A
440 x 41 x H311 cm



Uprights with Tobacco finish wood molding;
container units in Tobacco finish wood
and curved bronze glass doors;
fused bronze glass shelves.

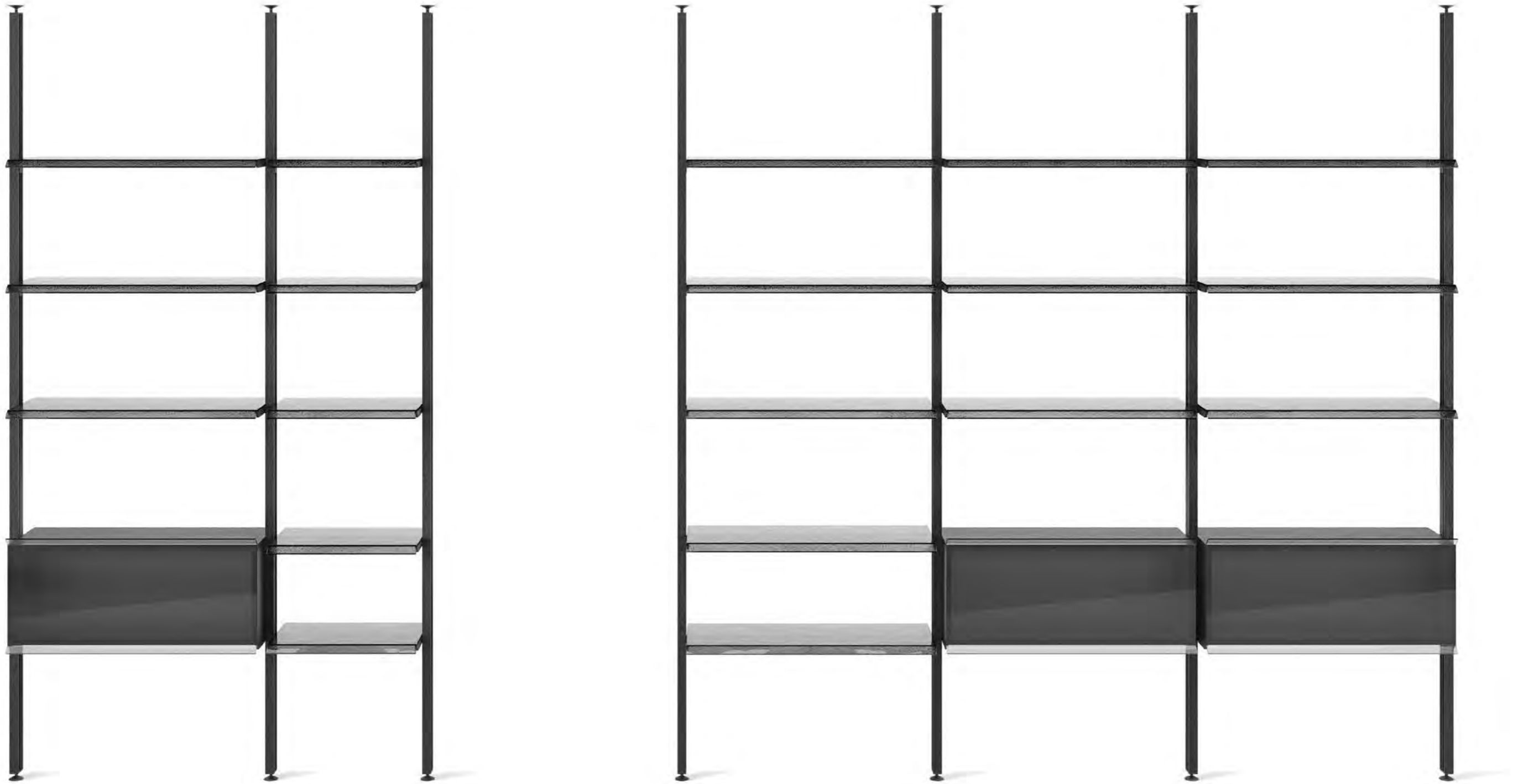

Uprights with Black finish wood molding;
container units in Black finish wood
and curved smoked glass doors;
fused smoked glass shelves.



Uprights with Black finish wood molding;
fused extralight glass shelves.











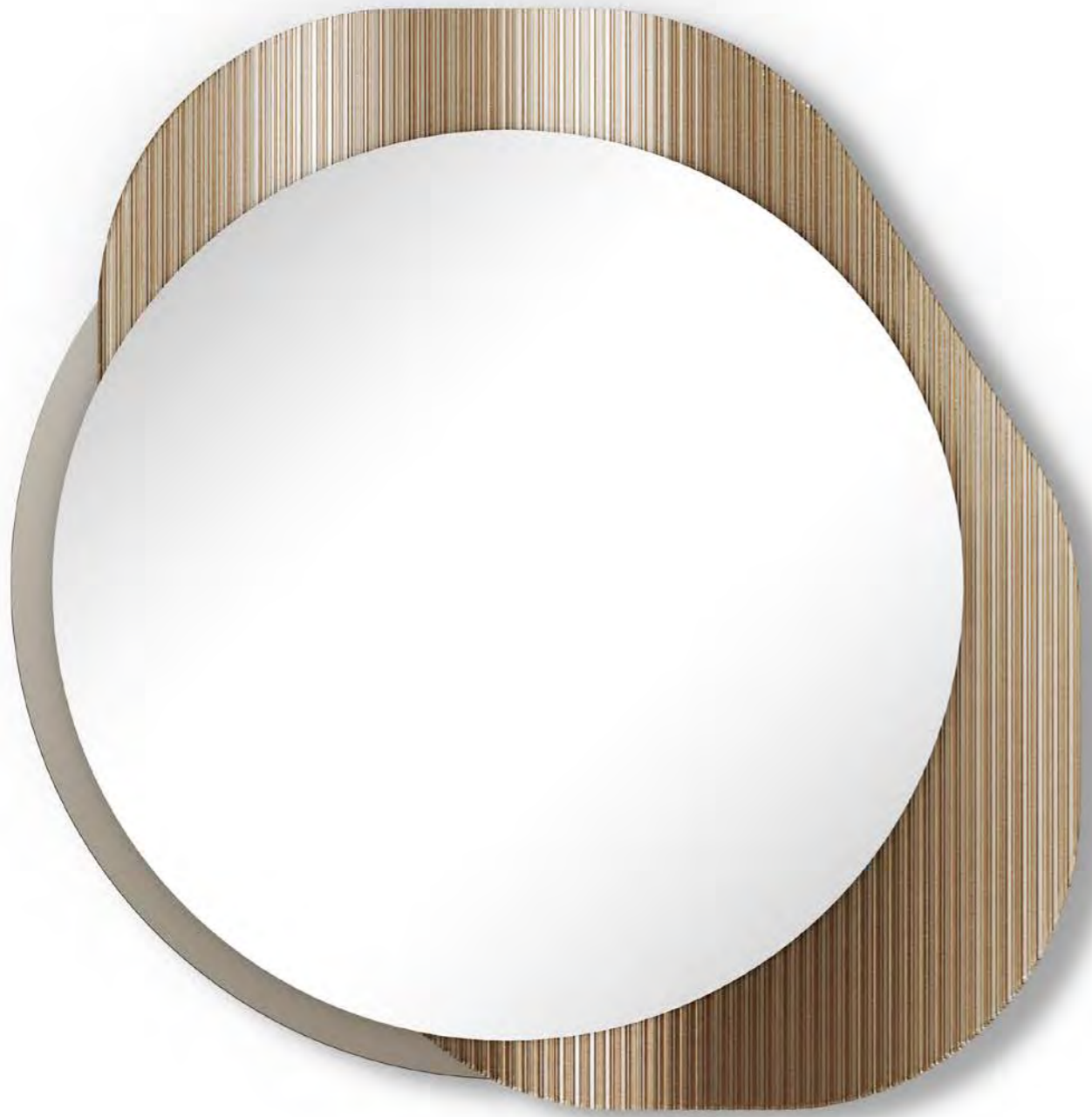

shift

design Francesca Lanzavecchia

Dall'incontro tra linee ortogonali e superfici smussate nasce la nuova famiglia di specchi Shift pensata per Fiam, un insieme di complementi plastici e monomaterici generati dalla pasta viscosa del vetro. La ricerca fra la designer e l'azienda celebra così l'expertise di Fiam nella tecnica della vetrofusione, dando vita a nuove espressioni del vetro con pattern tridimensionali decorativi unici, frutto di una precisione industriale combinata a una cura artigianale. I formati da parete o dalle dimensioni più contenute si adattano ai diversi luoghi della casa, dove rifrangono le immagini restituendo segmenti di una realtà che è molto più della semplice somma delle parti.

From the encounter between orthogonal lines and beveled surfaces comes the new Shift collection of mirrors designed by Francesca Lanzavecchia for Fiam; a set of plastic and monomaterial complements arising from the glass viscous paste. The research conducted by the designer and the company thus celebrates Fiam's expertise in the glass fusing technique, giving life to new expressions of glass with unique three-dimensional decorative patterns as a result of industrial precision combined with craftsmanship. Wall-mounted or smaller-sized formats adapt to different home spaces, where they refract images by returning segments of a reality that is much more than the simple sum of its parts.

De la rencontre entre lignes orthogonales et surfaces biseautées naît la nouvelle famille de miroirs Shift conçue pour Fiam, un ensemble de compléments plastiques et mono-matériaux générés par la pâte visqueuse du verre. La recherche entre le designer et l'entreprise célèbre ainsi le savoir-faire de Fiam dans la technique de la fusion du verre, en donnant naissance à de nouvelles expressions du verre avec des motifs décoratifs tridimensionnels uniques, résultat de la précision industrielle alliée à l'artisanat. Les formats muraux ou plus petits sont adaptés aux différents lieux de la maison, où ils réfractent les images en restituant des segments d'une réalité qui est bien plus que la simple somme de ses parties.

Aus dem Zusammentreffen von orthogonalen Linien und abgeschrägten Oberflächen entsteht die neue Spiegelkollektion Shift von Francesca Lanzavecchia. Eine Einheit von plastischen und monomaterialen Elementen, die von der zähflüssigen Glasmasse erzeugt werden. Die von der Designerin und dem Unternehmen durchgeführte Forschung unterstreicht das Know-how von Fiam in der Glasschmelztechnik und bringt neue Ausdrucksformen von Glas mit einzigartigen dreidimensionalen dekorativen Mustern hervor, die das Ergebnis von industrieller Präzision in Verbindung mit handwerklichem Können sind. Die an der Wand montierten Formate passen sich den verschiedenen Wohnräumen an, wo sie die Bilder brechen und die Segmente eine Realität wiedergeben, die viel mehr ist als die einfache Summe ihrer Teile.

Part of the frame in fused and back-silvered bronze glass;
part of the frame in bronze flat glass.

111 x 5 x 114 cm



Part of the frame in fused and back-silvered glass;
part of the frame in smoked flat glass.
87 x 5 x 182 cm

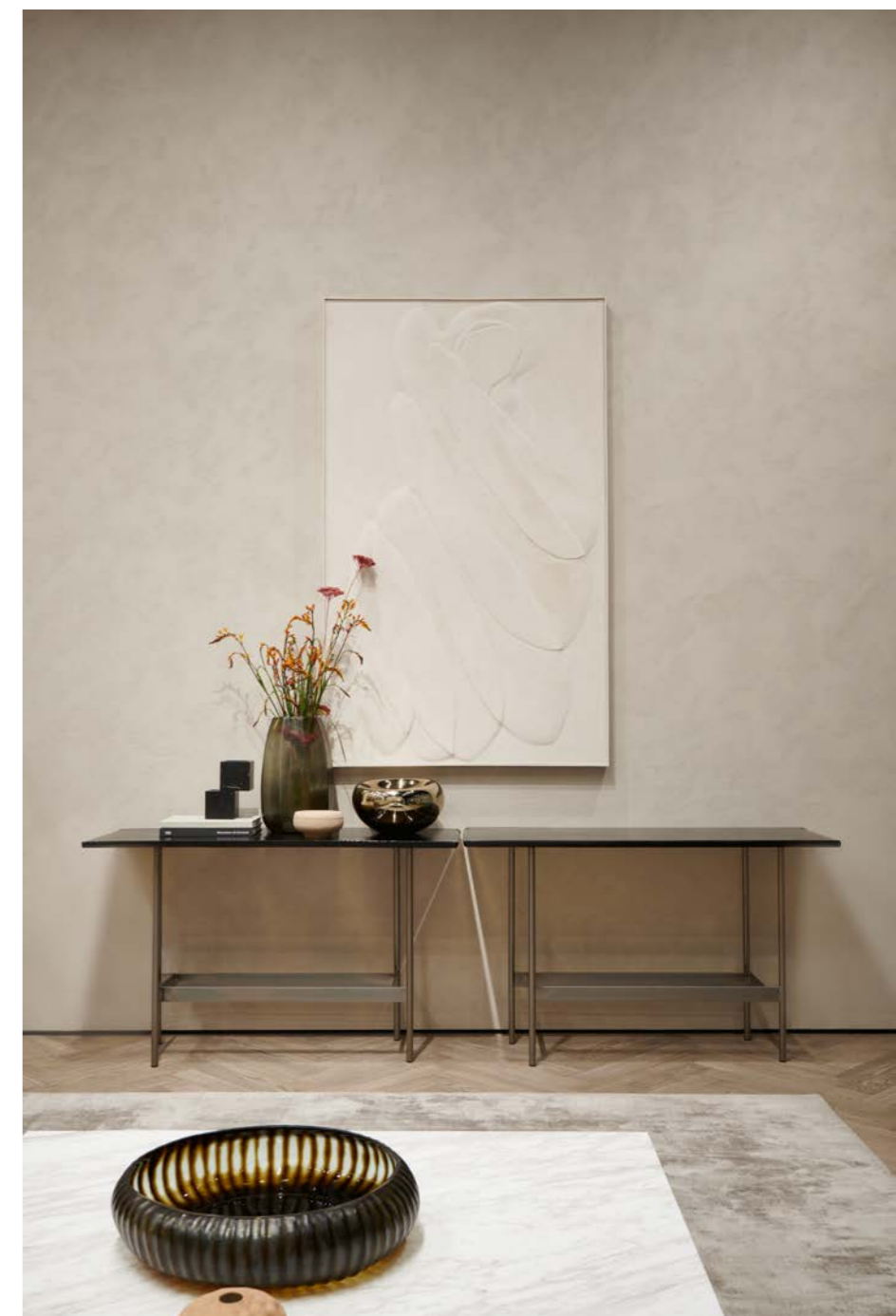



50th
FIAM

FIAM



50th
FIAM







silica

design Arik Levy

La collezione di specchi Silica vuole ridisegnare i nostri interni e i loro riflessi in modo nuovo. Agendo come un ribelle visivo, interagisce con lo spazio creando riflessi infiniti e inaspettati. Emozioni e sensazioni sono favorite dal contrasto tra la superficie chiara e l'ambiente circostante, dove le linee incrociate e la texture amorfa frammentano la luce e fanno risaltare l'immagine. Lo specchio Silica è disponibile in diversi formati, i quali lavorano tutti insieme in osmosi attraverso linee goffrate, consentendo infinite composizioni.

The Silica mirrors collection comes to redraw our interiors and its reflections in a new way. By acting as a visual rebel, it interacts with the space creating endless and unexpected reflections. Emotions and feelings are fostered by the contrast between the clear facet and its surroundings, where the crisscrossed lines and the amorphous texture fragment the light and make the image stand out. Silica mirror come in different formats, all working together in osmosis through the embossed lines, allowing infinite compositions.

La collection de miroirs Silica vient redessiner nos intérieurs et ses reflets d'une nouvelle manière. En agissant comme un rebelle visuel, elle interagit avec l'espace en créant des reflets infinis et inattendus. Les émotions et les sentiments sont favorisés par le contraste entre la facette claire et son environnement, où les lignes entrecroisées et la texture amorphe fragmentent la lumière et font ressortir l'image. Les miroirs de silice se présentent sous différents formats, tous travaillant ensemble en osmose à travers les lignes gaufrées, ce qui permet des compositions infinies.

Die Kollektion von Spiegel Silica zeichnet unsere Innenräume und deren Spiegelungen auf eine neue Art. Als visueller Rebell interagiert er mit dem Raum und schafft endlose und unerwartete Reflexionen. Emotionen und Gefühle zeigen sich durch den Kontrast zwischen der klaren Fläche und ihrer Umgebung und die kreuzenden Linien und die amorphe Textur das Licht brechen und das Bild hervorheben. Die Spiegel Silica sind in verschiedenen Formaten erhältlich, die alle durch gaufrierte Linien osmosweise zusammenwirken und unendliche Kompositionen ermöglichen.



Fused and back-silvered smoked glass frame
100 x 6 x 200 cm

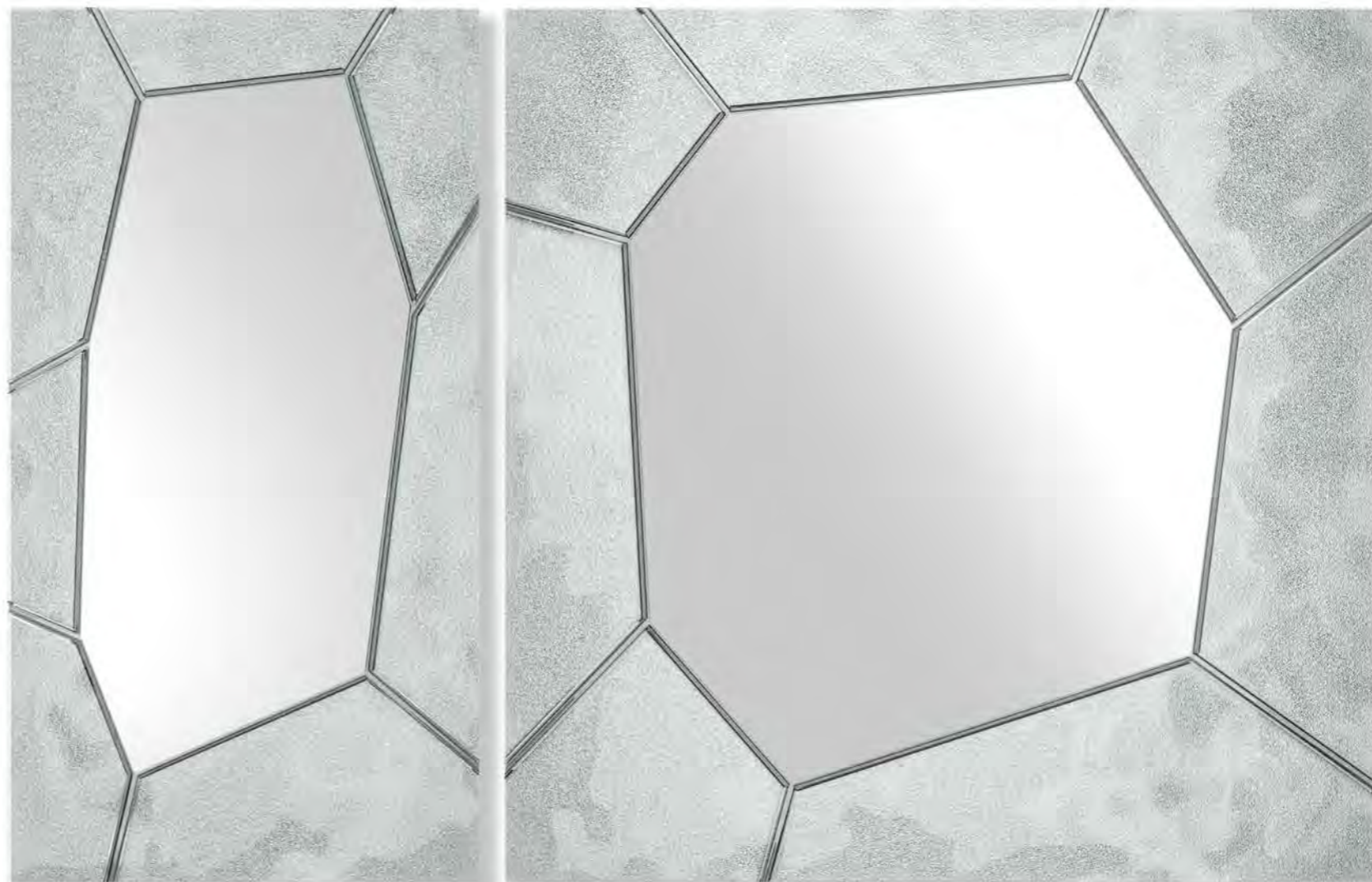

Fused and back-silvered glass frame
100 x 6 x 200 cm

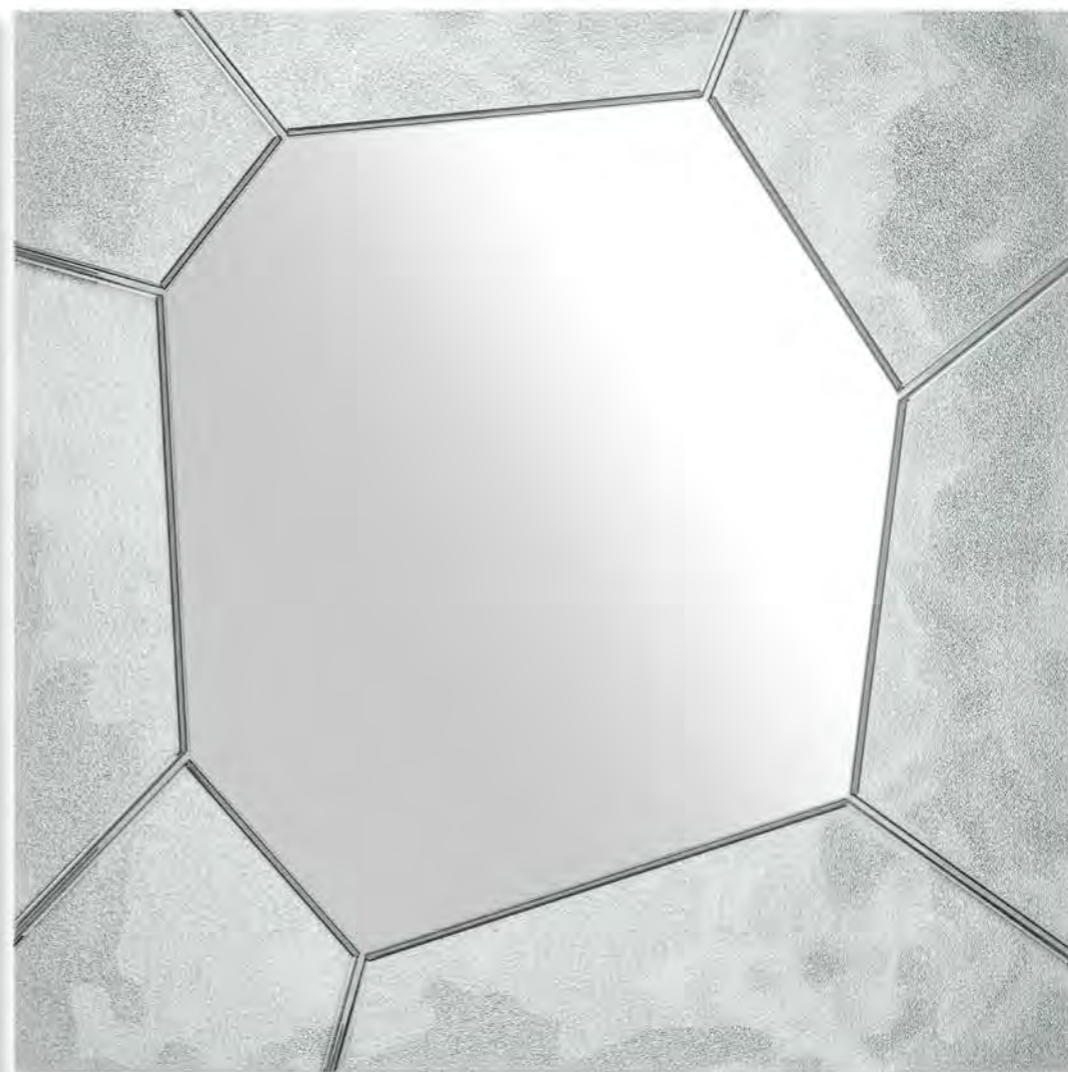

Fused and back-silvered glass frame
200 x 6 x 200 cm

Fused and back-silvered bronze glass frame
200 x 6 x 200 cm



Fused and back-silvered bronze glass frame
100 x 6 x 100 cm











marry me

design Davide Oppizzi

Davide Oppizzi ha voluto esprimere la stretta intimità tra vetro e luce nella sua nuova collezione Marry Me, sfruttando il DNA di Fiam in tutta la sua precisione, delicatezza e profondità. Per creare questo delicato incontro, Davide Oppizzi ha lavorato soprattutto sull'idea che la luce dovesse distanziarsi dal vetro circolare, per conferirgli tutto il suo volume e la sua struttura. Il punto di giunzione è quindi un elemento chiave, poiché si trova al centro del disco di vetro. Come per un anello e il suo diamante, il morsetto metallico eredita la sua eleganza dal mondo della gioielleria, con la sua finitura preziosa ed elaborata.

In his new Marry Me collection Davide Oppizzi wanted to express the close intimacy between glass and light, exploiting Fiam's DNA in all its precision, elegance, and depth. To create this delicate encounter Davide Oppizzi primarily focused on the idea that light should distance itself from the circular glass in order to transfer all its volume and structure. Hence the seam point becomes a key element, being located in the center of the glass disc. Like a ring with its diamond, the metal clamp inherits its elegance from the world of jewelry, with its precious and elaborated finish.

Davide Oppizzi a voulu exprimer l'intimité entre le verre et la lumière dans sa nouvelle collection Marry Me, en exploitant l'ADN de Fiam dans toute sa précision, sa délicatesse et sa profondeur. Pour créer cette rencontre délicate, Davide Oppizzi a surtout travaillé sur l'idée que la lumière devait être éloignée du verre circulaire, pour lui donner tout son volume et sa structure. Le point de jonction est donc un élément clé, puisqu'il est situé au centre du disque de verre. Comme une bague et son diamant, la pince métallique hérite son élégance de l'univers de la joaillerie, avec sa finition précieuse et travaillée.

Davide Oppizzi wollte in seiner neuen Kollektion Marry Me die Intimität zwischen Glas und Licht zum Ausdruck bringen, indem er die DNA von Fiam in all ihrer Präzision, Zartheit und Tiefe nutzte. Um diese zarte Begegnung zu schaffen, arbeitete Davide Oppizzi vor allem mit der Idee, dass das Licht von dem kreisförmigen Glas weggeführt werden sollte, um ihm sein ganzes Volumen und seine Struktur zu verleihen. Der Verbindungspunkt ist daher ein Schlüsselement, da er sich in der Mitte der Glasscheibe befindet. Wie ein Ring und sein Diamant erbt die Metallklammer ihre Eleganz aus der Welt des Schmucks, mit ihrer kostbaren und bearbeiteten Verarbeitung.

Decorative diffuser
in fused bronze glass,
with geometric texture



Decorative diffuser in fused smoked glass,
with geometric texture.

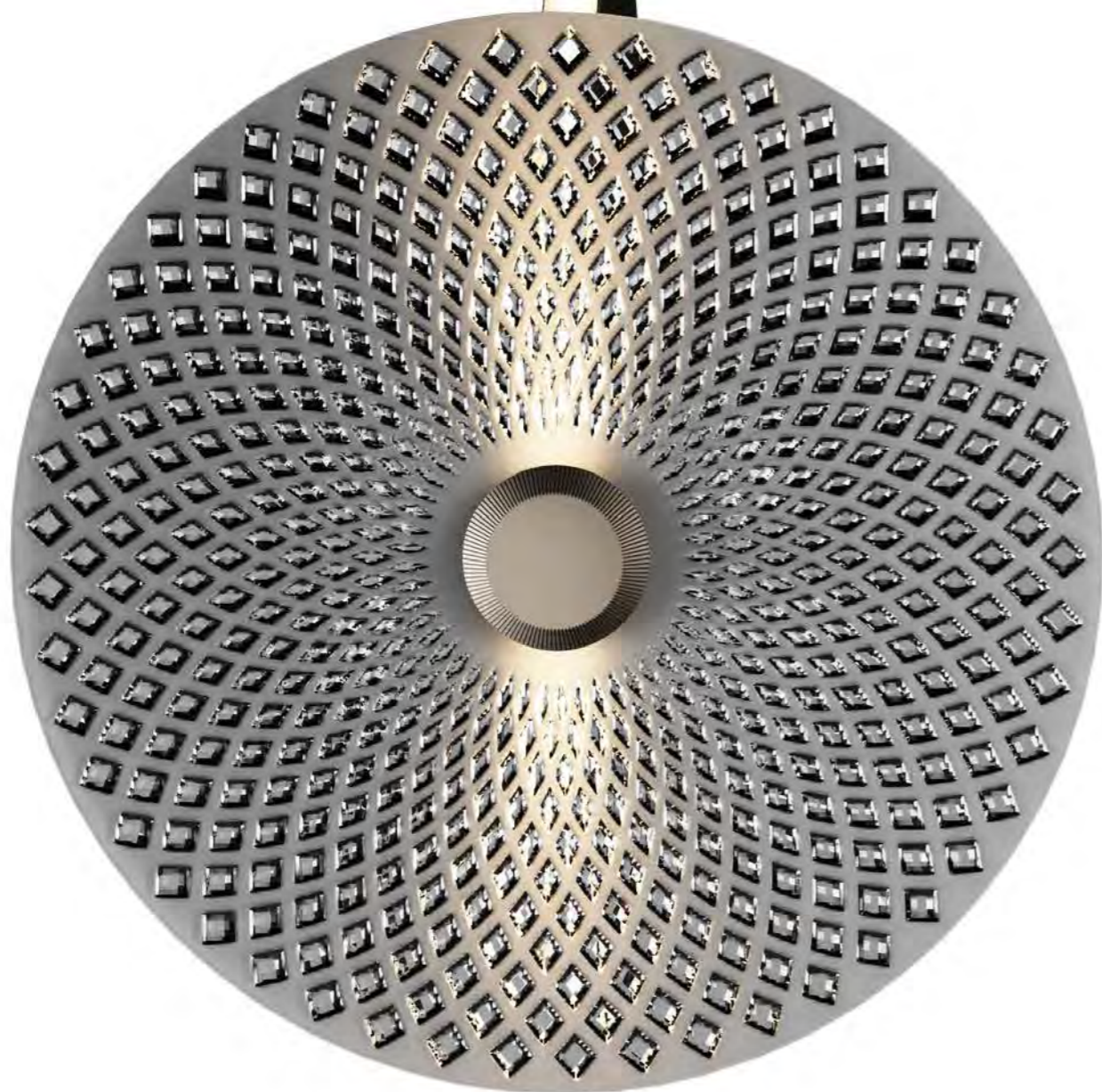

Decorative diffuser in fused smoked glass,
with organic texture.

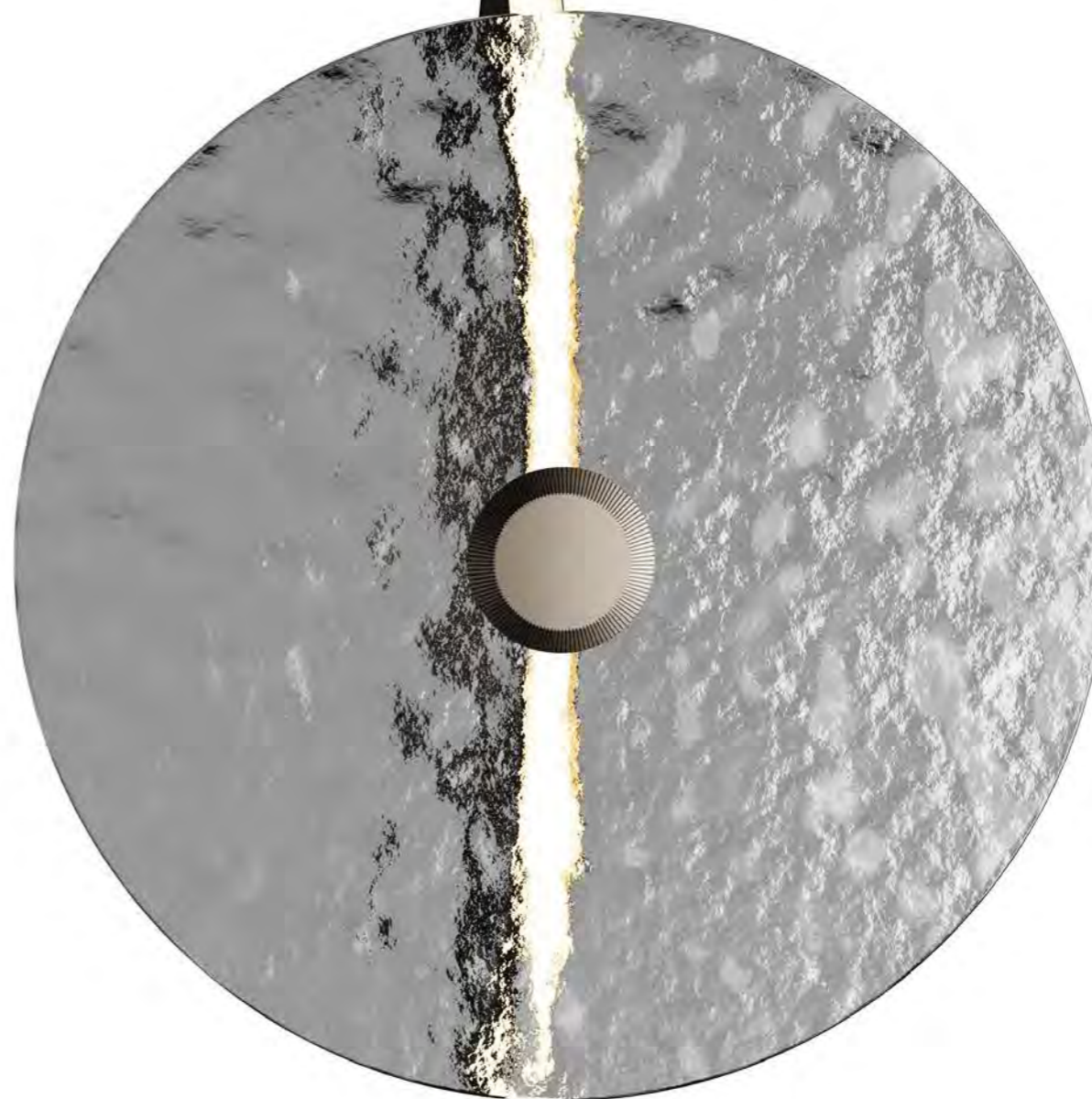



Decorative diffuser in fused smoked glass,
with geometric texture.
Fixed composition of 2 element (MME-CPT2)

Cristaline consolle:
Black Glossy Nichel finish metal base;
Carnico Grey marble top.





Decorative diffuser in fused bronze glass, with organic texture.

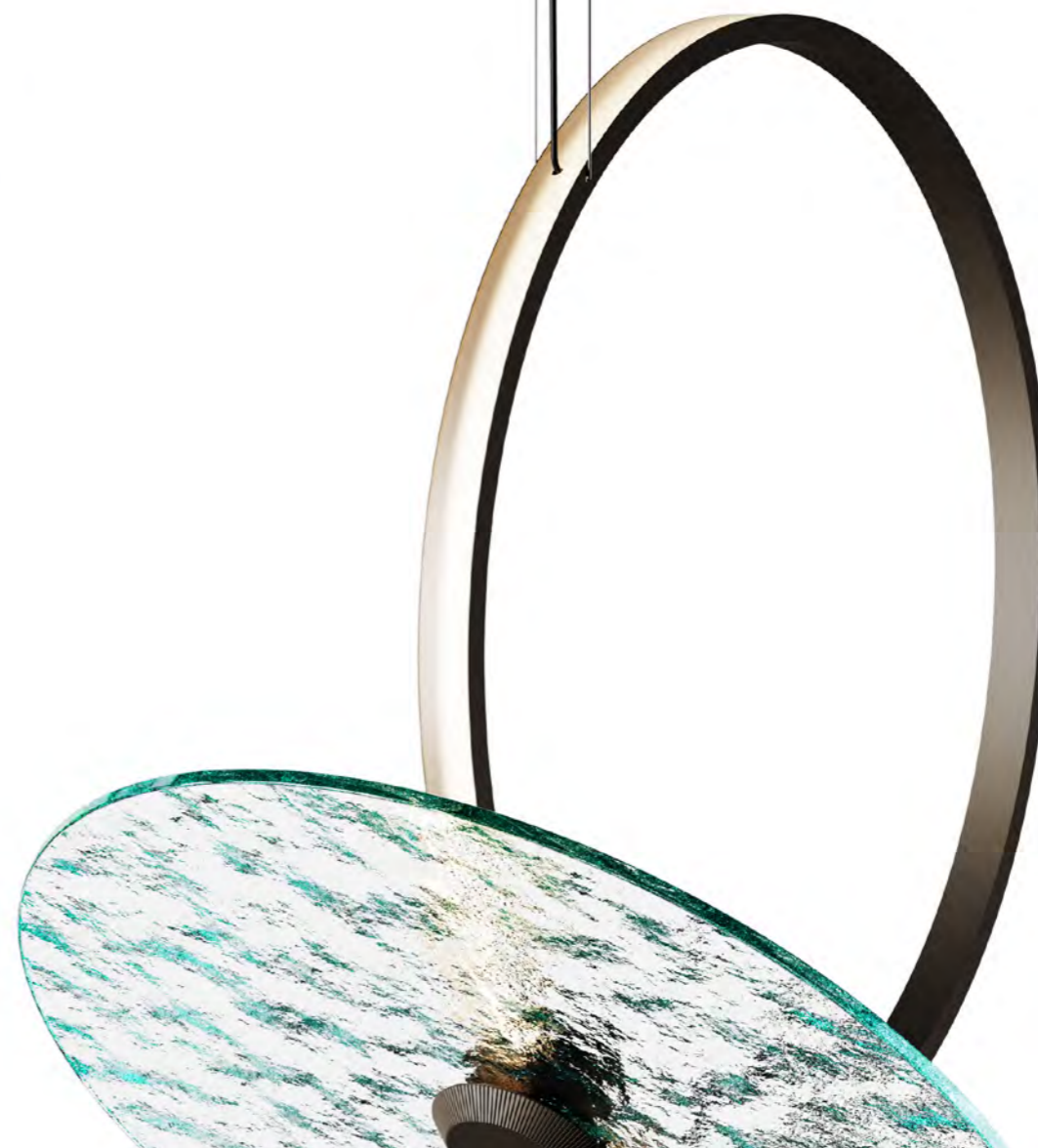

Decorative diffuser in fused extralight glass, with organic texture.









cristaline

design Marcel Wanders studio



La collezione Cristaline, creata da Marcel Wanders, è completata da un gruppo di tavolini e da una consolle. Sperimentando l'esclusiva tecnica artigianale della fusione e della formatura del vetro in lastra propria del marchio FIAM, questa collezione incarna grazia e bellezza per creare un pattern superficiale che esemplifica la geometria e la natura attraverso un complesso motivo floreale. Traendo ispirazione dal tradizionale bouquet in vaso per la tavola, questo motivo sostituisce i fiori naturali ad eterne incisioni di fiori trasparenti e cristallizzati su ogni tavolo. Accogliendo per sempre la bellezza organica e la natura in casa.

The Cristaline collection designed by Marcel Wanders studio, expands with a group of coffee tables and a console. This collection expresses subtle beauty and grace creating an intricate superficial texture that exemplifies geometry and nature through a decorative floral pattern; a tangible output of the constant experimentation in the field of glass fusing and manufacturing conducted by the Brand FIAM with its unique technologies. Drawing inspiration from the traditional center table bouquet, this pattern substitutes natural flowers with eternal engravings of transparent, crystalized flowers on every table welcoming organic beauty and nature.

La collection Cristaline, créée par Marcel Wanders, est complétée par un groupe de tables basses et une console. Cette collection illustre la beauté subtile et la grâce en expérimentant la technologie unique de fusion et de courbure du verre, maîtrisée par la marque d'artisanat verrier FIAM, pour créer un motif complexe et superficiel qui illustre la géométrie et la nature à travers un motif floral complexe. En s'inspirant du traditionnel bouquet dans un vase, ce motif remplace les fleurs naturelles par des gravures éternelles de fleurs transparentes et cristallisées sur chaque table. La beauté organique et la nature s'invitent à jamais dans la maison.

Die vom Studio Marcel Wanders entworfene Kollektion Cristaline wird durch eine Gruppe von Couchtischen und eine Konsole erweitert. Diese Kollektion drückt subtile Schönheit und Anmut aus, indem sie eine komplizierte Oberflächenstruktur schafft, die Geometrie und Natur durch ein dekoratives Blumenmuster veranschaulicht; ein greifbares Ergebnis der ständigen Experimente im Bereich der Glasverschmelzung und -herstellung, die von der Marke FIAM mit ihren einzigartigen Technologien durchgeführt werden. In Anlehnung an den traditionellen Blumenstrauß in einer Vase ersetzt dieses Muster die natürlichen Blumen durch ewige Gravuren von transparenten und kristallisierten Blumen auf jedem Tisch. Organische Schönheit und die Natur ziehen für immer in Ihr Zuhause ein.

Black Glossy Nichel finish metal base;
fused transparent glass top;
Manhattan marble top.

Ø 50 x h 50 cm
Ø 80 x h 40 cm



Black Glossy Nichel finish metal base;
Carnico Grey marble top;
fused transparent glass top;
fused and back-painted glass top,
Brilliant Black finish.

Ø 110 x h 30 cm
Ø 50 x h 50 cm
Ø 80 x h 40 cm



Black Glossy Nichel finish metal base;
fused and back-painted glass top,
Brilliant Black finish;
Carnico Grey marble top.
Ø 80 x h 40 cm
Ø 50 x h 50 cm



Opaque Titanium finish metal base;
Mystic Brown marble top;
Calacatta Royal marble top;
fused and back-painted glass top,
Brilliant Brown finish.
Ø 110 x h 30 cm
Ø 80 x h 40 cm

Technical data

DRAWINGS AND FINISHING

shift

design Francesca Lanzavecchia



Parte cornice in vetro liscio _ Flat glass frame part



vetro fumé
smoked glass



vetro bronzo
bronze glass

Parte cornice in vetro fuso _ Fused glass frame part



Vetro fuso
retroargentato
Back-silvered
fused glass



Vetro bronzo fuso
e retroargentato
Fused and back-silvered
bronze glass

rettangolare / rectangular

87 x 182 cm
34 1/4" x 71 5/8"

quadrato / square

112 x 112 cm
44 1/8" x 44 1/8"

tondo / round

111 x 114 cm
43 11/16" x 44 7/8"

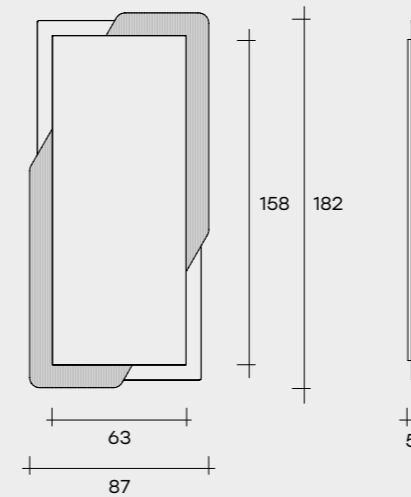
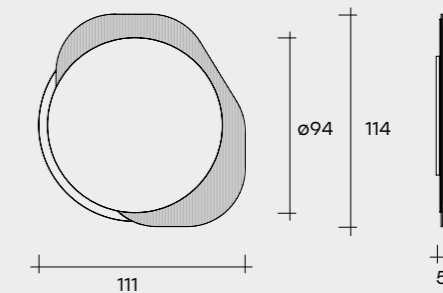
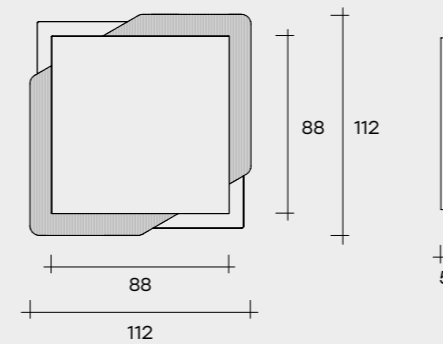

Specchio da parete o da terra con cornice composta da due elementi in vetro: parte in vetro trasparente o bronzo da 6 mm fuso a gran fuoco retroargentato; parte in vetro piano fumé o bronzo da 6 mm. Specchio piano da 5 mm. Telaio posteriore, in metallo verniciato. Possibilità di appendimento verticale od orizzontale.

Free-standing or hanging mirror with frame composed of two glass elements: a part in 6 mm-thick high-temperature fused glass in transparent or bronze finish; a part in 6 mm-thick flat glass in smoked or bronze finish. 5 mm-thick flat mirror. Rear frame, in painted metal. It can be hung horizontally or vertically.

Miroir appuyant au sol ou accrochable avec cadre composé de deux éléments en verre : partie en verre en fusion transparent ou bronze argenté dessous de 6 mm ; partie en verre plat fumé ou bronze de 6 mm. Miroir plat de 5 mm. Cadre arrière en métal verni. Possibilité d'accrochage en vertical ou en horizontal.

Stand- bzw Wandspiegel mit Rahmen aus zwei Glasteilen: ein Teil aus verschmolzenem, versilbertem Glas, 6 mm Stärke, Ausführung Transparent oder Bronze und ein Teil aus flachem Spiegel, 6mm Stärke, Ausführung Rauchglas oder Bronze. Flacher Spiegel 5 mm. Hinterer Rahmen, aus lackiertem Metall. Kann waagrecht oder senkrecht aufgehängt werden.

silica

design Arik Levy

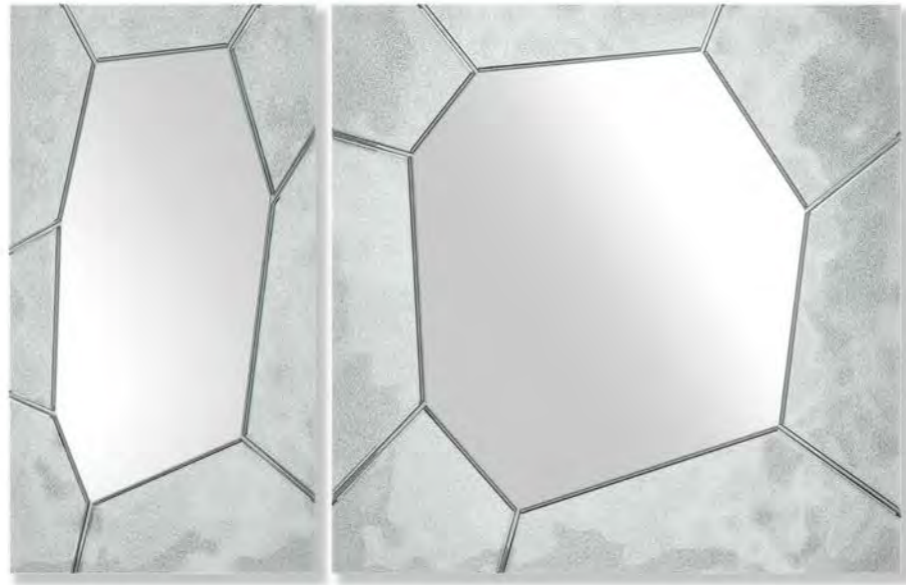

Cornice in vetro fuso _ Fused glass frame



Vetro fuso
retroargentato
*Back-silvered
fused glass*

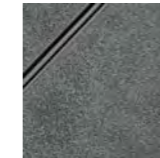

Vetro fumé fuso
e retroargentato
*Fused and back-silvered
smoked glass*

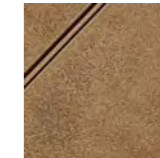

Vetro bronzo fuso
e retroargentato
*Fused and back-silvered
bronze glass*

rettangolare / rectangular

100 x 200 cm
39 3/8" x 78 3/4"

155 x 240 cm
61" x 94 1/2"

quadrato / square

100 x 100 cm
39 3/8" x 39 3/8"

200 x 200 cm
78 3/4" x 78 3/4"

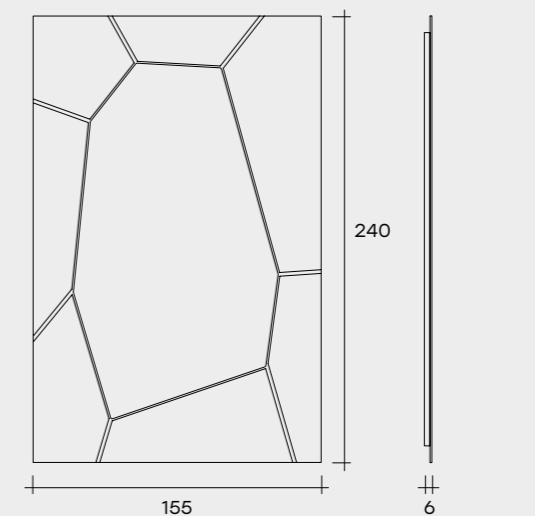
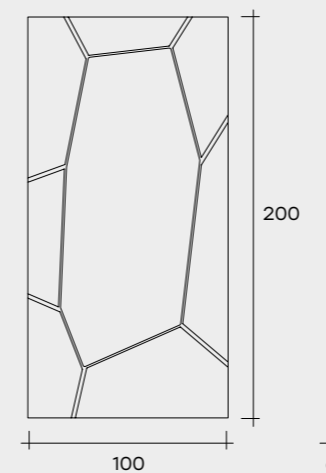
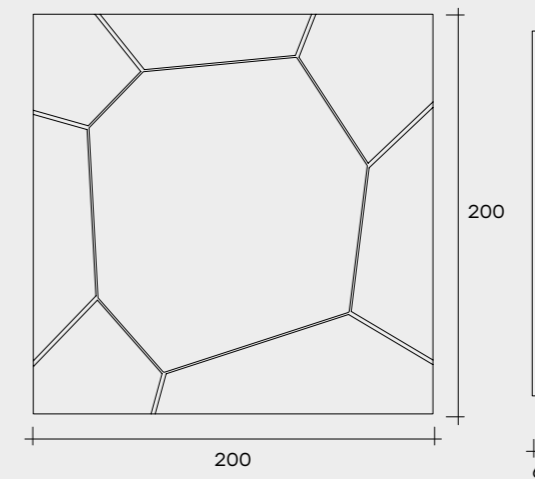
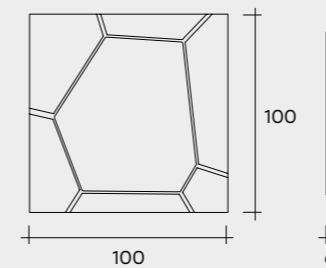

Specchio da parete o da terra con cornice in vetro da 6 mm fuso a gran fuoco e retroargentato, con texture ottenuta da un decoro artigianale realizzato a mano. Specchio piano da 5 mm. Telaio posteriore in metallo verniciato. Possibilità di appendimento in verticale od orizzontale.

Free-standing or hanging mirror with 6 mm-thick high-temperature fused and back-silvered glass frame, with texture achieved from a handcrafted decoration. 5 mm-thick flat mirror. Painted metal rear frame. It can be hung horizontally or vertically.

Miroir appuyant au sol ou accrochable avec cadre en verre en fusion argenté dessous de 6mm, texturé et décoré à la main. Miroir plat de 5mm. Cadre arrière en métal verni. Possibilité d'accrochage en vertical ou en horizontal.

Stand- bzw Wandgespiegel aus verschmolzenem, versilbertem Glasrahmen, 6mm, mit handwerklich gefertigter Textur. Flacher Spiegel 5 mm Stärke. Hinterer Rahmen aus lackiertem Metall. Kann waagrecht oder senkrecht aufgehängt werden.

flaminio

design Studio Klass



Piano in vetro fuso _ Fused glass top



Vetro retroverniciato
Nero Brillante
*Back-painted glass,
Brilliant Black finish*



Vetro retroverniciato
Marrone Brillante
*Back-painted glass,
Brilliant Brown finish*

Base in legno massello _ Solid wood base



Termotrattato nero
Heath-treated black

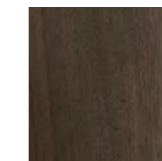

Tabacco
Tobacco

240 x 110 x 75 cm
94 1/2" x 43 5/16" x 29 1/2"
270 x 110 x 75 cm
106 5/16" x 43 5/16" x 29 1/2"
300 x 110 x 75 cm
118 1/8" x 43 5/16" x 29 1/2"

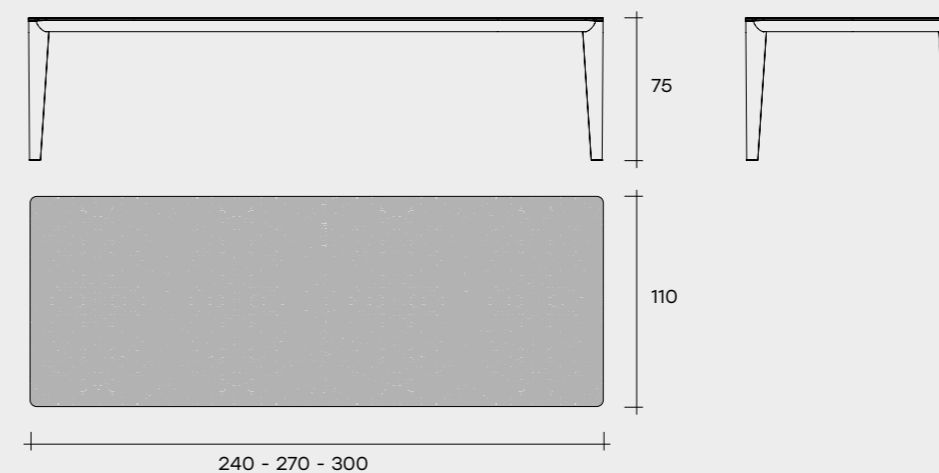

Tavolo con piano in vetro da 12 mm fuso a gran fuoco e temperato, retroverniciato con tinte metallizzate. Struttura in legno massello disponibile nelle finiture Tabacco o termotrattato nero.

Table with 12 mm fused and tempered glass top, back-painted with with metallic paints. Solid wood structure available in Tobacco or heat-treated black finish.

Table avec plateau en verre en fusion de 12 mm trempé, disponible dans les teintes métallisées. Structure en bois massif disponible dans les finitions Tabac ou thermotraité noir.

Tisch mit Platte aus 12 mm geschmolzenem und gehärtetem Glas mit metallischen Farben unterlackiert. Massiv-Holz Gestell in den Varianten Tabak oder schwarz thermobehandelt erhältlich.

cristaline

design Marcel Wanders studio



Piano in vetro fuso _ Fused glass top



Vetro trasparente
Transparent glass



Vetro retroverniciato
Nero Brillante
Back-painted glass,
Brilliant Black finish



Vetro retroverniciato
Marrone Brillante
Back-painted glass,
Brilliant Brown finish

Piano in marmo _ Marble top



Grigio Carnico
Carnico grey



Mystic Brown
Mystic Brown

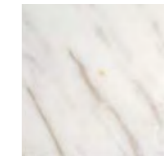

Calacatta Roya
Calacatta Roya

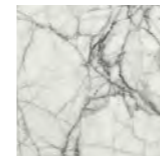

Manhattan
Manhattan

Base in metallo _ Metal base

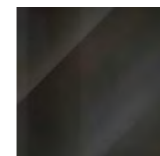

Nichel Nero Lucido
Black Glossy Nickel



Titanio Opaco
Opaque Titanium

ø 50 x 50 cm
 ø 19 11/16" x 19 11/16"
 ø 80 x 40 cm
 ø 31 1/2" x 15 3/4"
 ø 110 x 30 cm
 ø 43 5/16" x 11 13/16"

Tavolino con piano in vetro da 10 mm fuso a gran fuoco e temperato, disponibile trasparente o retroverniciato con tinte metallizzate. Piano disponibile anche in marmo. Base in metallo finitura Titanio opaco oppure Nichel Nero lucido.

Coffee table with top in 10 mm fused and tempered glass, available transparent or back-painted with metallic paints. Top available also in marble. Metal base available in opaque Titanium or in Black Glossy Nickel finishes.

Table basse avec plateau en verre de 10 mm en fusion et trempé, disponible transparent ou vernie dessous avec des teintes métallisées. Plateau disponible aussi en marbre. Base en métal, finition Titane opaque ou Nickel noir brillant.

Couchtisch mit Platte aus 10 mm geschmolzenem und gehärtetem Glas, transparent oder mit metallischen Farben unterlackiert. Variante mit Marmorplatte erhältlich. Untergestell aus Metall in den folgenden Farbvarianten: Matt Titan oder Glanz Schwarz Nickel.

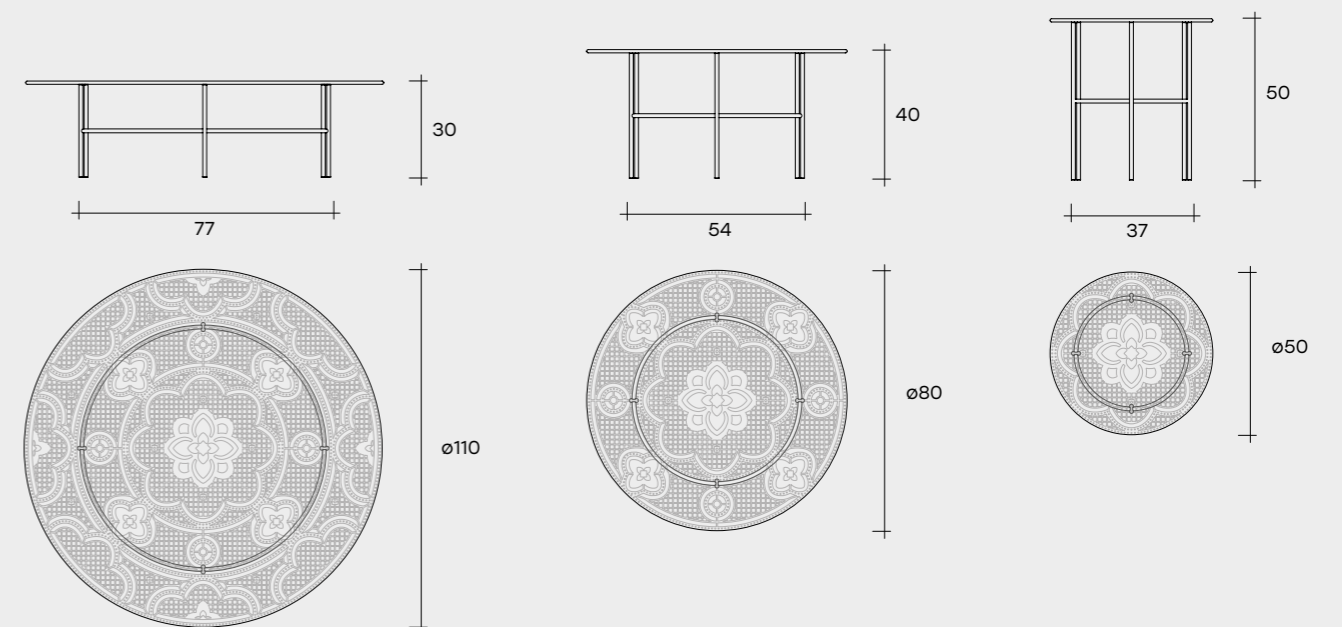

crystaline

design Marcel Wanders studio



Piano in vetro fuso _ Fused glass top



Vetro extralight
Extralight glass



Vetro extralight
retroverniciato
Nero Brillante
Back-painted
extralight glass,
Brilliant Black finish



Vetro extralight
retroverniciato
Marrone Brillante
Back-painted
extralight glass,
Brilliant Brown finish

Piano in marmo _ Marble top



Grigio Carnico
Carnico grey



Mystic Brown
Mystic Brown

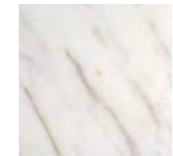

Calacatta Roya
Calacatta Roya

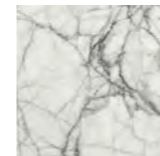

Manhattan
Manhattan

Base in metallo _ Metal base

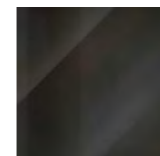

Nichel Nero Lucido
Black Glossy Nickel



Titanio Opaco
Opaque Titanium

130 x 48 x 75 cm
51 ³/₁₆" x 18 ⁷/₈" x 29 ¹/₂"
147 x 48 x 75 cm
57 ⁷/₈" x 18 ⁷/₈" x 29 ¹/₂"

Consolle con piano in vetro extralight da 15 mm fuso a gran fuoco e temperato, disponibile trasparente o retroverniciato con tinte metallizzate. Piano disponibile anche in marmo. Base in metallo finitura Titanio opaco oppure Nichel Nero lucido.

Console with top in 15 mm fused and tempered extralight glass, available transparent or back-painted with metallic paints. Top available also in marble. Metal base available in opaque Titanium or in Black Glossy Nickel finishes.

Console avec plateau en verre extra light de 15mm en fusion et trempé, disponible transparent ou vernie dessous avec des teintes métallisées. Plateau disponible aussi en marbre. Base en métal, finition Titane opaque ou Nickel noir brillant.

Konsole mit Platte aus 15mm extralight geschmolzenem und gehärtetem Glas, transparent oder mit metallischen Farben unterlackiert. Variante mit Marmorplatte erhältlich. Untergestell aus Metall in den folgenden Farbvarianten: Matt Titan oder Glanz Schwarz Nickel.

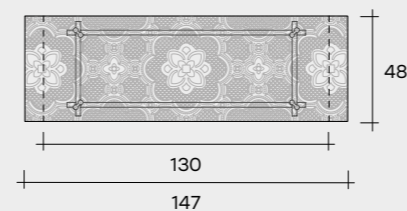
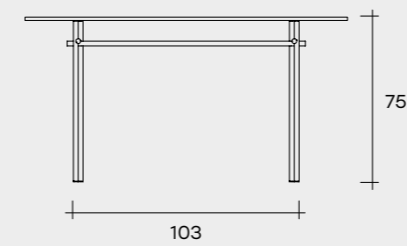

remind

design Simone Bonanni

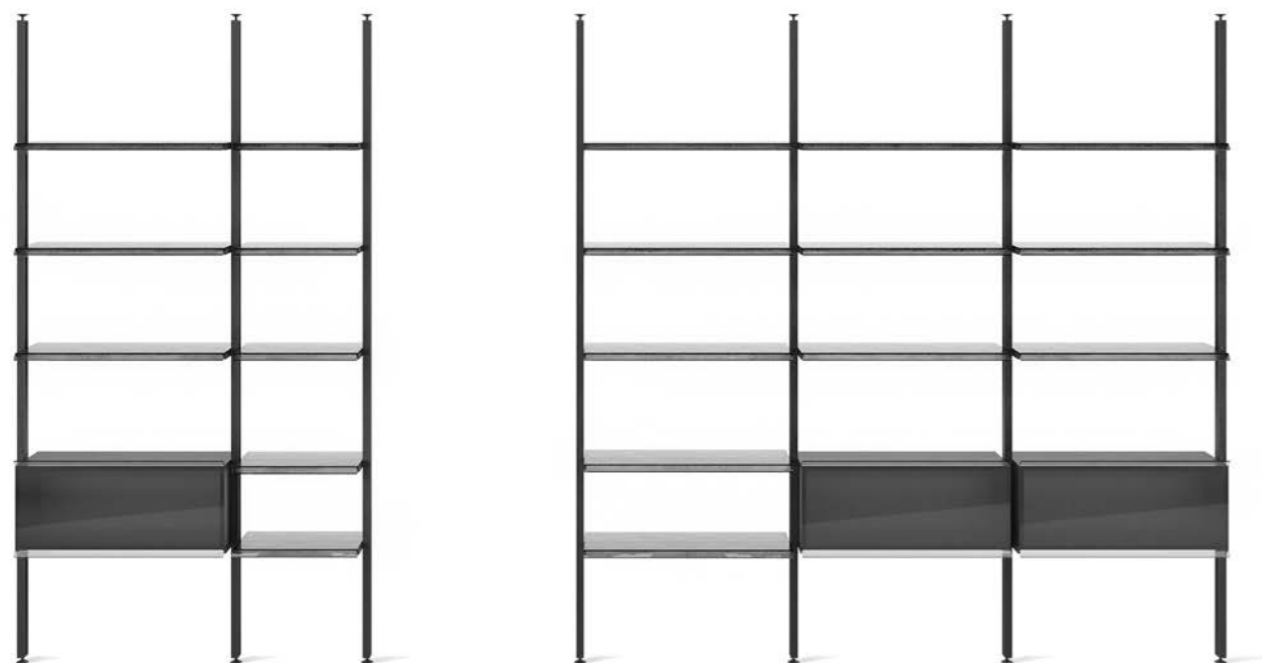

Libreria modulare a parete in alluminio, vetro e legno, disponibile in versione con fissaggio a soffitto oppure con fissaggio a parete. Struttura composta da montanti verticali e traversi in alluminio anodizzato nero. I montanti verticali presentano una modanatura in legno massello. Ripiani da 60 o 100 cm in vetro extralight, fumè o bronzo da 8 mm fuso a gran fuoco. Elementi contenitori da 100 cm con struttura in nobilitato finitura legno ed ante a ribalta in vetro curvato da 6 mm extralight, fumè o bronzo.

Modular bookcase in glass, aluminium and wood, available in ceiling-mounted or wall-mounted configuration. Structure composed of vertical and crossing uprights made of black anodized aluminium. Vertical uprights feature solid wood moulding. 60 or 100 cm shelves made of 8 mm high temperature fused glass in extralight, smoked or bronze finish. 100 cm storage units with structure in melamine, wood finish and drop-down doors in 6 mm extralight, smoked or bronze curved glass.

Bibliothèque murale modulaire en aluminium, verre et bois, disponible en version plafonnière ou murale. Structure composée de montants verticaux et de traverses en aluminium anodisé noir. Les montants verticaux sont dotés d'une moulure en bois massif. Tablettes de 60 ou 100 cm en verre extralight, fumé ou bronze de 8 mm coulé au feu. Éléments de rangement de 100 cm avec structure en mélaminé finition bois et portes à rabat en verre cintré extralight, fumé ou bronze de 6 mm.

Modulares Wandbücherregal aus Glas, Aluminium und Holz. Ausführungen mit Deckenbefestigung oder mit Wandbefestigung. Die Struktur besteht aus vertikalen Pfosten und Querträgern aus schwarz eloxiertem Aluminium, vertikale Pfosten mit Massivholzabdeckung. 60- oder 100-cm verschmolzene Glasfachböden, Stärke 8 mm, in den Varianten extralight oder rauch oder bronze. Melamin-Holz Behälterelemente, L.100 cm, mit Glasklapptüren Stärke 6 mm, in den Varianten extralight oder rauch oder bronze.

Modanature verticali in legno _ Vertical uprights wood mulsing
Mobile contenitore in legno _ Wood container unit



Tabacco
Tobacco



Termotrattato nero
Heath-treated black

Ante in vetro curvato _ Curved glass doors



Vetro extralight
Extralight glass

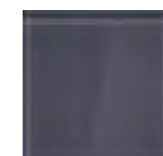

Vetro fumé
Smoked glass



Vetro bronzo
Bronze glass

Ripiani in vetro fuso _ Fused glass shelves



Vetro extralight fuso
Fused extralight glass



Vetro fumé fuso
Fused smoked glass

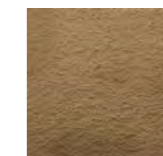

Vetro bronzo fuso
Fused bronze glass

Struttura in alluminio _ Aluminium structure



Nero
Black

NOTE TECNICHE

Libreria con fissaggio a parete: altezze standard: H 240 cm - H 260 cm - H 280 cm - H 311 cm.

Altezze su richiesta: H max 311 cm.

Libreria con fissaggio a soffitto: Solo altezze su richiesta: H max 315 cm.

Entrambe le versioni prevedono l'impiego di staffe di ancoraggio per assicurare i montanti a parete: non è possibile in nessun caso collocare la libreria in configurazione "centro stanza" (freestanding). I supporti per il posizionamento dei ripiani e dei contenitori sono fissati ai montanti con un sistema a pressione e possono essere posizionati all'altezza desiderata.

NOTES TECHNIQUES

Bibliothèque murale : hauteurs standard : H 240 cm - H 260 cm - H 280 cm - H 311 cm.

Hauteurs sur demande : H max 311 cm.

Bibliothèque avec fixation au plafond : hauteurs uniquement sur demande : H max 315 cm.

Les deux versions nécessitent l'utilisation de pattes d'ancrage pour fixer les montants au mur : il n'est en aucun cas possible de placer la bibliothèque en configuration "centre de la pièce" (autoportante). Les supports pour le positionnement des étagères et des éléments de rangement sont fixés aux montants par un système de pression et peuvent être positionnés à la hauteur souhaitée.

TECNICAL NOTES

Wall-mounted bookcase: standard heights: H 240 cm - H 260 cm - H 280 cm - H 311 cm.

Custom heights: H max 311 cm.

Ceiling-mounted bookcase: Custom heights only: H max 315 cm.

Both versions require the use of fastening brackets to secure the uprights to the wall: it is not possible under no circumstances to place the bookcase in a configuration in the middle of the room (freestanding). The supports for the installation of the relevant shelves and storage units are attached to the uprights with a pressure system and can be positioned at the required height.

TECHNISCHE HINWEISE

Standardhöhen Wandausführung:

H. 240 cm - H. 260 cm - H. 280 cm - H. 311 cm.

Höhe auf Anfrage bis zu H. max 311 cm.

Bücherregal mit Deckenbefestigung,

nur Höhen auf Anfrage: H. max 315 cm.

Beide Ausführungen erfordern die Verwendung von Verankerungsbügel um die Pfosten an der Wand zu befestigen: die Konfiguration "Raummitte" (freistehend) ist es auf keinen Fall möglich. Frei verstellbare Höhe der Fachböden und Behälterelementen durch einen Drucksystem.

remind

design Simone Bonanni

MONTANTI _ UPRIGHTS

Versione con fissaggio a parete
Wall-mounting version

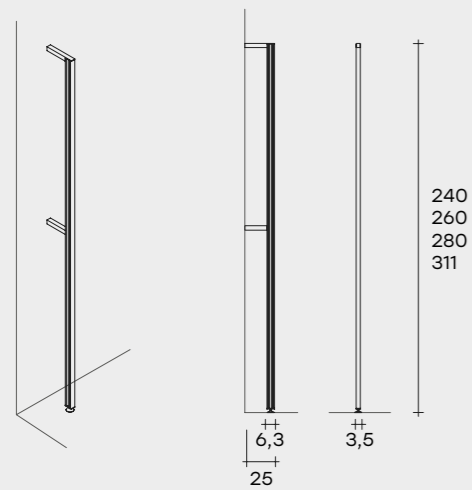

Versione con fissaggio a soffitto
Ceiling-mounting version

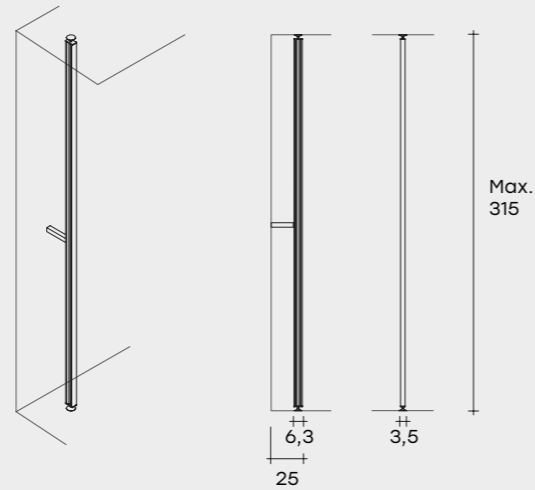

MOBILE CONTENITORE _ CONTAINER UNIT

Mobile contenitore con anta in vetro curvato
Container unit with curved glass door

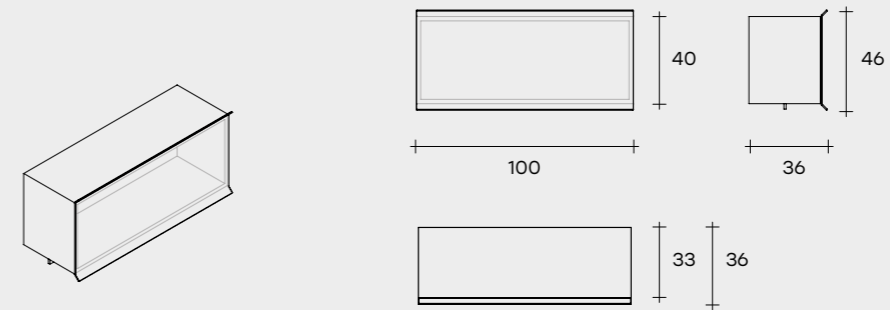

RIPIANI _ SHELF

Ripiano in vetro fuso
Fused glass shelf

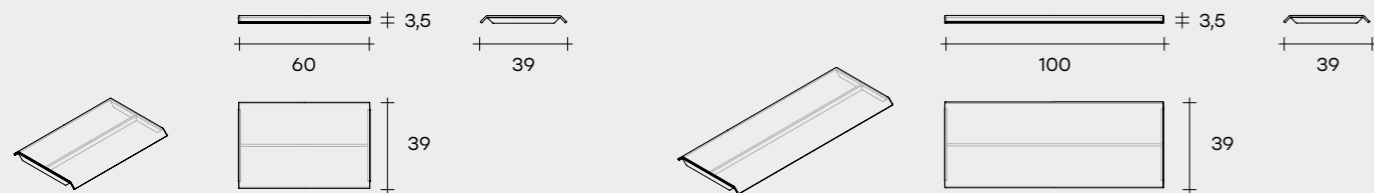

ACCESSORIO PER FISSAGGIO TV _ TV FIXING ACCESSORY

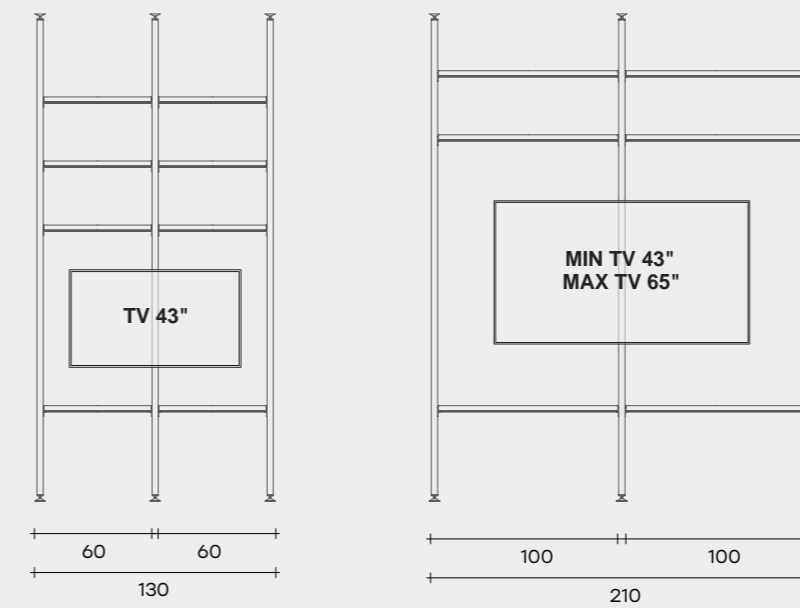

remind

design Simone Bonanni

COMPOSIZIONI _ COMPOSITIONS

COMP-3A

3 montanti H 311 cm con fissaggio a parete
10 ripiani L 100 cm

3 wall-mounting uprights, H 311 cm
10 shelves L 100 cm

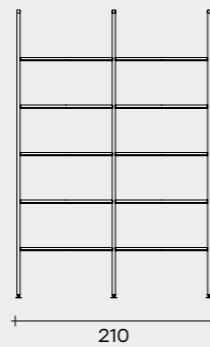

COD./CODE	L	P/W	H
REM/COMP-3A	210	41	311

COMP-4A

4 montanti H 311 cm con fissaggio a parete

4 ripiani L 100 cm
8 ripiani L 60 cm

4 wall-mounting uprights, H 311 cm
4 shelves L 100 cm
8 shelves L 60 cm

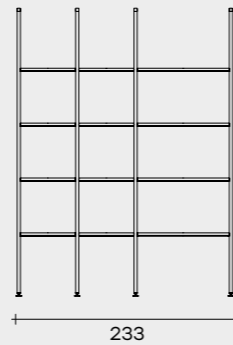

COD./CODE	L	P/W	H
REM/COMP-4A	233	41	311

COMPOSIZIONI _ COMPOSITIONS

COMP-4B

4 montanti H 311 cm con fissaggio a parete

9 ripiani L 100 cm
3 mobili contenitori

4 wall-mounting uprights, H 311 cm
9 shelves L 100 cm
3 container units

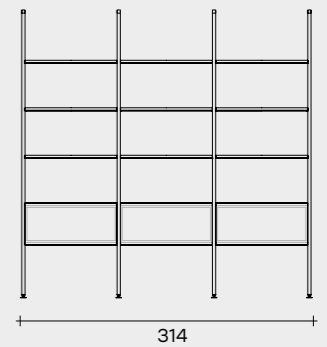

COD./CODE	L	P/W	H
REM/COMP-4B	314	41	311

COMP-5A

5 montanti H 311 cm con fissaggio a parete

4 ripiani L 100 cm
12 ripiani L 60 cm

5 wall-mounting uprights, H 311 cm
4 shelves L 100 cm
12 shelves L 60 cm

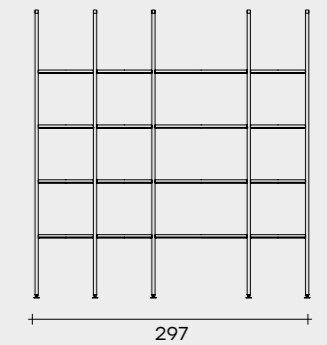

COD./CODE	L	P/W	H
REM/COMP-5A	297	41	311

remind

design Simone Bonanni

COMPOSIZIONI _ COMPOSITIONS

COMP-5B

5 montanti H 311 cm con fissaggio a parete
 15 ripiani L 100 cm
 5 ripiani L 60 cm
 5 wall-mounting uprights, H 311 cm
 15 shelves L 100 cm
 5 shelves L 60 cm

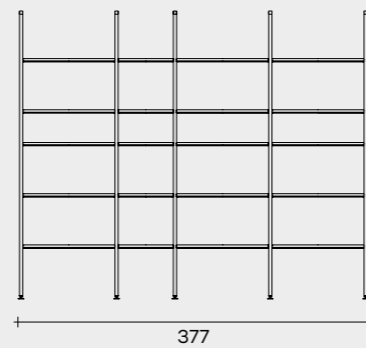

COD./CODE	L	P/W	H
REM/COMP-5B	377	41	311

COMP-5C

5 montanti H 311 cm con fissaggio a parete
 11 ripiani L 100 cm
 5 ripiani L 60 cm
 2 mobili contenitori
 5 wall-mounting uprights, H 311 cm
 11 shelves L 100 cm
 5 shelves L 60 cm
 2 container units

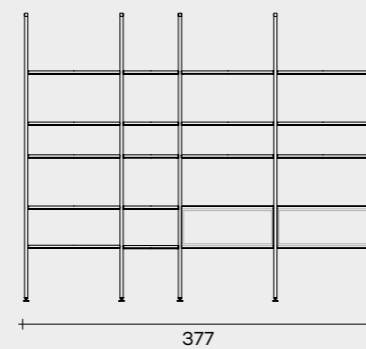

COD./CODE	L	P/W	H
REM/COMP-5C	377	41	311

COMPOSIZIONI _ COMPOSITIONS

COMP-6A

6 montanti H 311 cm con fissaggio a parete
 15 ripiani L 100 cm
 10 ripiani L 60 cm
 6 wall-mounting uprights, H 311 cm
 15 shelves L 100 cm
 10 shelves L 60 cm

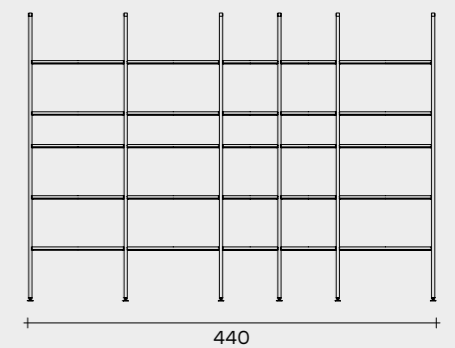

COD./CODE	L	P/W	H
REM/COMP-6A	440	41	311

COMP-6B

6 montanti H 311 cm con fissaggio a parete
 15 ripiani L 100 cm
 5 mobili contenitori
 6 wall-mounting uprights, H 311 cm
 15 shelves L 100 cm
 5 container units

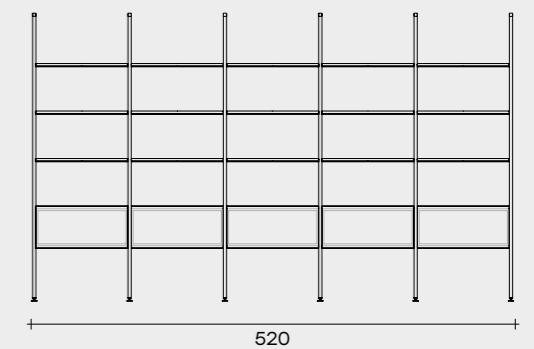

COD./CODE	L	P/W	H
REM/COMP-6B	520	41	311

marry me

design Davide Oppizzi



Diffusore in vetro fuso con texture organica _ Fused glass diffuser with organic texture



Extralight
Extralight



Fumé
Smoked

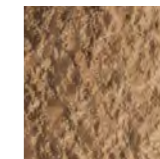

Bronzo
Bronze

Diffusore in vetro fuso con texture geometrica _ Fused glass diffuser with geometric texture



Extralight
Extralight

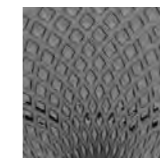

Fumé
Smoked

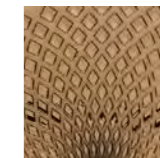

Bronzo
Bronze

Struttura in alluminio _ Aluminium structure

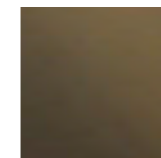

Bronzo medio
Mid-Bronze

38 x 52 x 110 cm
15" x 220 1/2" x 43 5/16"

Lampada a sospensione per interni con struttura ad anello in alluminio finitura Mid-Bronze e diffusore in materiale plastico bianco opale. Fonte luminosa a led integrata nella struttura. Diffusore decorativo in vetro extralight, fumè o bronzo da 6mm fuso a gran fuoco, disponibile in 2 varianti di texture: "organica" o "geometrica".

Suspension lamp for indoor use with Mid-Bronze finish aluminum ring structure and opal white plastic diffuser. LED light source integrated within the structure. Decorative diffuser made of 6mm-thick high temperature fused glass in extralight, smoked or bronze finish, available in 2 texture variants: "organic" or "geometric".

Lampe à suspension pour l'intérieur avec structure annulaire en aluminium en finition Mid-Bronze et diffuseur en plastique blanc opale. Source lumineuse LED intégrée dans la structure. Diffuseur décoratif en verre en fusion extralight, fumé ou bronze de 6 mm, disponible en 2 variantes de texture : "organique" ou "géométrique".

Hängeleuchte mit Ringstruktur aus Aluminium, Farbe Mid-Bronze. Kunststofflichtdiffusor opalweiß. LED-Lichtquelle in der Struktur integriert. Dekorativer Lichtschirm aus verschmolzenem Glas in den Varianten extralight oder Rauch oder Bronze erhältlich. 2 Texturvarianten: "organisch" oder "geometrisch".

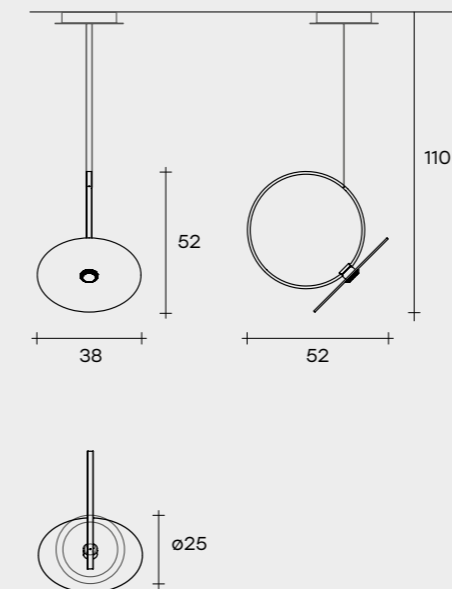

marry me

design Davide Oppizzi

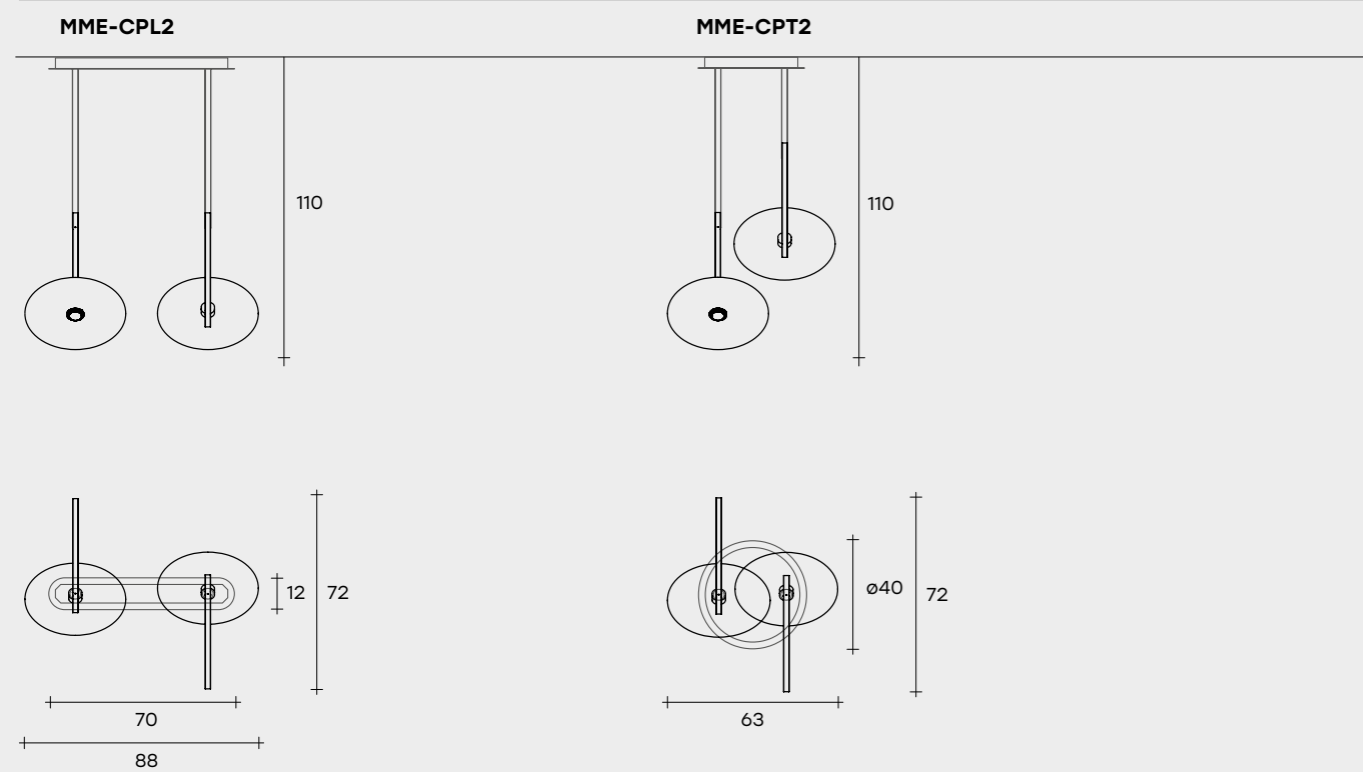

COD./CODE	L	P/W	H
MME-CPL2	88	72	110
MME-CPT2	63	72	110

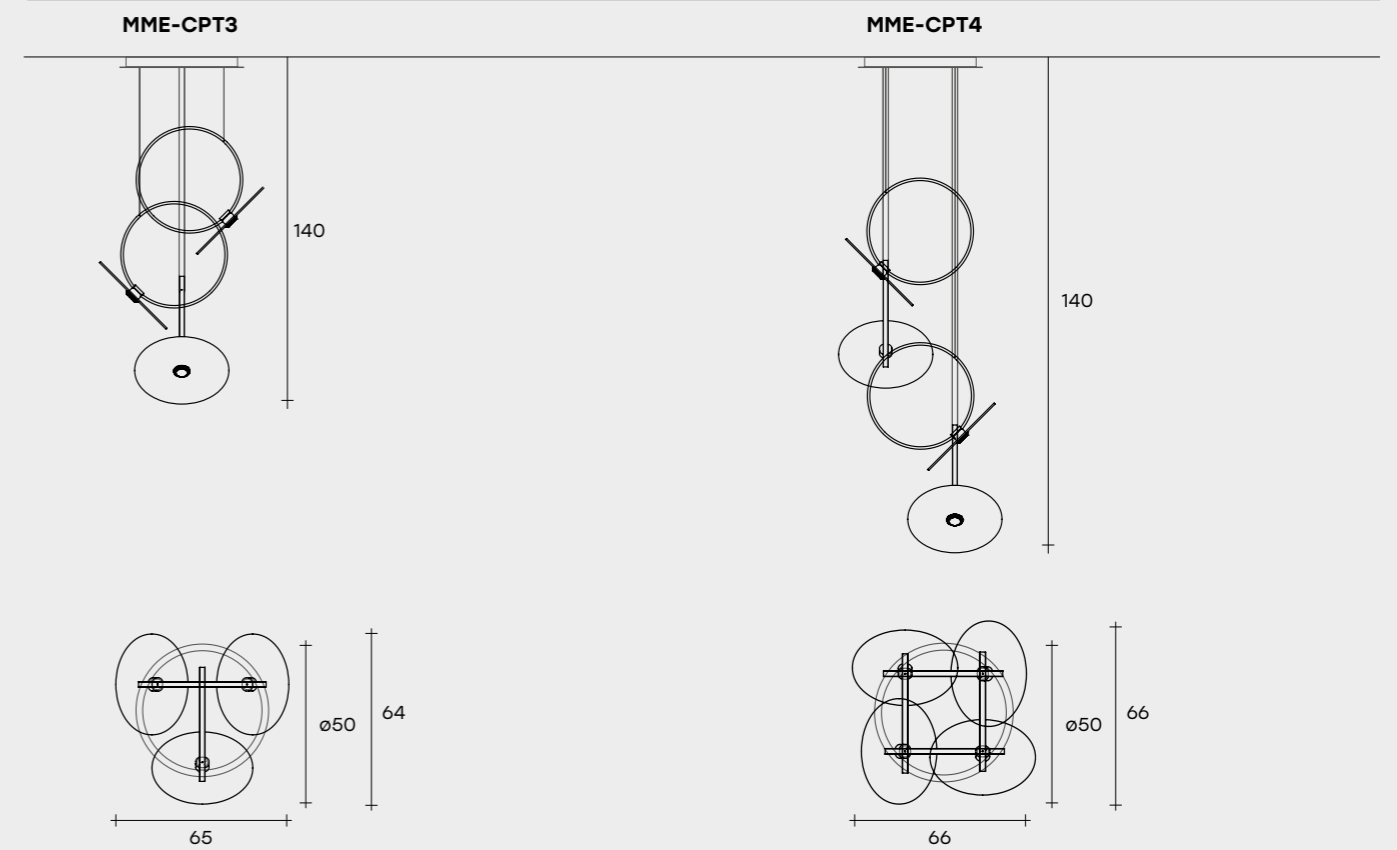

COD./CODE	L	P/W	H
MME-CPT3	65	64	140
MME-CPT4	66	66	200

credits

art direction
adele martelli

photography and post production
studio leon

graphic design
acanto comunicazione

rendering images
acanto comunicazione

marketing project
daniele livi

coordination and logistics
lorenzo marzoli

may 2023

Carlo Moretti

Cooee Design

FiammettaV

GUAXS

Sergio colleoni Art

SkLO

Fiam Italia
Via Ancona 1/b
61010 Tavullia (PU)
Italy

T: +39 0721 20051
F: +39 0721 202432
info@fiamitalia.it

follow us on



fiamitalia.it