



<b>1</b>	FIAM, Cultura del vetro FIAM, the art of glass	8
	Designer e riconoscimenti Designers and awards	10
	Ecosostenibilità Ecosustainable	14
	Poltrona Ghost Ghost armchair	16
	Indice generale prodotti General product index	2
	<b>SPECCHI MIRRORS</b>	20
	<b>SPECCHI TV MIRRORS-TV</b>	128
	<b>ESPOSITORI, VETRINE, CONTENITORI SHOWCASES, DISPLAY UNITS, CONTAINER CABINETS</b>	140
	<b>LIBRERIE, SISTEMI BOOKSHELVES, SYSTEMS</b>	184
	<b>MENSOLE SHELVES</b>	200
	<b>ACCESSORI ACCESSORIES</b>	214
	<b>I Customizzabili The Customizables</b>	232
	<b>Schede tecniche Technical data sheets</b>	250
	<b>Materiali Materials</b>	312
	<b>Mini collection Mini collection</b>	314
	<b>Garanzia di qualità e certificazioni Garantee of quality and certifications</b>	318

<b>2</b>	<b>TAVOLI TABLES</b>
	<b>TAVOLI BASSI E DI SERVIZIO COFFEE TABLES AND SIDE TABLES</b>
	<b>COMODINI BEDSIDE TABLES</b>
	<b>CONSOLLE CONSOLES</b>
	<b>SEDIE CHAIRS</b>

<b>3</b>	<b>HOME OFFICE CUSTOM MADE &amp; CONTRACT</b>
----------	---

# INDICE

## INDEX

## SOMMAIRE

## INHALTSVERZEICHNIS

ghost 16  
DESIGN  
CINI BOERI

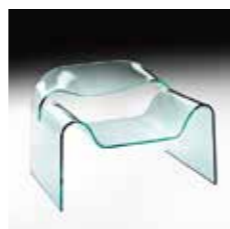

SPECCHI  
MIRRORS  
MIROIRS  
SPIEGEL

20

SPECCHI TV  
MIRRORS-TV  
MIROIRS-TV  
TV-SPIEGEL

128

admiral 114

DESIGN  
FABIO DI BARTOLOMEI



caadre 22

DESIGN  
PHILIPPE STARCK



caadre tv 130

DESIGN  
PHILIPPE STARCK



caldeira 66

DESIGN  
XAVIER LUST



christine 38

DESIGN  
HELIDON XHIXHA & DANTE O. BENINI - LUCA GONZO



dorian 72

DESIGN  
MASSIMO IOSA GHINI



hasami 102

DESIGN  
PAOLO RIZZATTO



hiroshi 106

DESIGN MARTA LAUDANI,  
ROBERTO ROMANELLI



let me see 116

DESIGN  
RODOLFO DORDONI



lucy 78

DESIGN  
DORIANAE MASSIMILIANO FUKSAS



mary 84

DESIGN  
DORIANAE MASSIMILIANO FUKSAS



mir 110

DESIGN  
ROBERTO PAOLI



mir lampada 112

DESIGN  
ROBERTO PAOLI



mirage 118

DESIGN  
DANIEL LIBESKIND



mirage tv 136

DESIGN  
DANIEL LIBESKIND



phantom 46

DESIGN  
HELIDON XHIXHA & DANTE O. BENINI - LUCA GONZO



# INDICE

## INDEX

## SOMMAIRE

## INHALTSVERZEICHNIS

**SPECCHI**  
MIRRORS  
MIROIRS  
SPIEGEL

20

**reverso 126**

DESIGN  
LEONARDO DAINELLI



**ritratto 122**

DESIGN  
MARTA LAUDANI, MARCO ROMANELLI



**rosy 88**

DESIGN  
DORIANA E MASSIMILIANO FUKSAS



**the wing 92**

DESIGN  
DANIEL LIBESKIND



**venus 58**

DESIGN  
VITTORIO LIVI



**ESPOSITORI,  
VETRINE,  
CONTENITORI**  
SHOWCASES,  
DISPLAY UNITS,  
CONTAINER  
CABINETS  
PRÉSENTOIRS,  
VITRINE, MEUBLES  
DE RANGEMENT  
REGALE, VITRINE,  
KASTEN

140

**aura 166**

DESIGN  
PATRICK JOUIN



**babele 178**

DESIGN  
MASSIMO MOROZZI



**magique totem 182**

DESIGN  
STUDIO KLASS



**milo day 160**

DESIGN  
ILARIA MARELLI



**milo day led 164**

DESIGN  
ILARIA MARELLI



**milo sideboard 156**

DESIGN  
ILARIA MARELLI



**palladio 170**

DESIGN  
VITTORIO LIVI



**palladio uno 176**

DESIGN  
VITTORIO LIVI



**plié 142**

DESIGN  
STUDIO KLASS



**varesina 148**

DESIGN  
MATTEO NUNZIATI



**LIBRERIE,  
SISTEMI**  
BOOKSHELVES,  
SYSTEMS  
BIBLIOTHÈQUES,  
SYSTÈMES  
BÜCHERREGALE,  
SYSTEME

184

**inori 186**

DESIGN  
SETSU E SHINOBU ITO



**inori freestanding 198**

DESIGN  
SETSU E SHINOBU ITO



# INDICE

## INDEX

## SOMMAIRE

## INHALTSVERZEICHNIS

**MENSOLE**  
SHELVES  
ETAGÈRES  
KONSOLE  
200

**babila 202**

DESIGN  
LUCA CASINI



**foulard 204**

DESIGN  
STUDIO KLASS



**mensole 208**

DESIGN  
GERUSSI - SARTORIS



**mensole rialto L 210**

DESIGN  
CRS FIAM



**ACCESSORI**  
ACCESSORIES  
ACCESSOIRES  
ACCESSOIRES  
214

**cobra 224**

DESIGN  
ELIO VIGNA



**elix 228**

DESIGN  
FABIO DI BARTOLOMEI



**homo sapiens 226**

DESIGN  
FABIO DI BARTOLOMEI



**l'astra 222**

DESIGN  
LO BIANCO-MANSUETO



**loy-k 216**

DESIGN  
CHAFIK GASMI



**mir lampada 220**

DESIGN  
ROBERTO PAOLI



**vogue 230**

DESIGN  
ROBERTO PAOLI



## FIAM, cultura del vetro

Il vetro è un materiale magico ed eterno, quasi avesse un'intrinseca sacralità. Io ho accolto la sfida di questo materiale sin da quando ero ragazzo facendolo diventare praticamente una missione. Gettando le basi per un progetto che sembrava alle sue origini improbabile; far diventare il vetro in lastra un materiale protagonista nell'arredamento. Incanto e poesia, ecco quello che ancora mi trasmette il vetro. L'incanto di una materia senza tempo. La poesia è la vanità di una materia capace di riflettere ciò che ci circonda e di moltiplicare i nostri punti di vista sul reale.

## FIAM, la culture du verre

Le verre est un matériau magique et éternel, qui semble posséder un caractère sacré intrinsèque. Dès mon plus jeune âge, j'ai voulu relever le défi de ce matériau, qui est bientôt devenu pour moi une mission. J'ai ainsi jeté les bases d'un projet qui semblait au départ improbable : conférer au verre en plaque une place de premier plan dans la décoration. Magie et poésie: ce sont les deux sensations que le verre m'a toujours procurées. La magie d'une matière intemporelle. La poésie, ou la vanité d'une matière capable de refléter tout ce qui nous entoure et de multiplier à l'infini nos perspectives sur la réalité.

## FIAM, the art of glass

Glass is a magical and ever lasting material, as if it possessed an innate sacredness. I was young when I first accepted the challenge that this material represented and I set the basis for a project that initially seemed so unlikely possible: making glass become a furnishings star. Charm and poetry are still what glass conveys to me. The magic of a timeless material. Poetry is the vanity of a material capable of mirroring all that surrounds it and to multiply our perceptions of reality.

## FIAM, die Kultur edles Glases

Glas ist ein zeitlos schönes Material mit magischer Ausstrahlung. Ich habe die Herausforderung dieses geheimnisvollen Materials schon in jungen Jahren angenommen, und in gewisser Weise zu meiner Mission auserkoren. Und damit die Grundlagen für ein Projekt geschaffen das zu Beginn beinahe aussichtslos erschien – die flache Glasscheibe zu einem Protagonisten der Einrichtung zu machen. Und auch heute noch vermittelt mir das Glas Zauber und Poesie. Den Zauber einer zeitlosen Materie. Die Poesie einer Materie, die ihre und unsere Umgebung reflektiert und unsere Blickpunkte auf die Realität vervielfacht.





Vittorio Livi

Compasso d'Oro  
alla carrieraPremio Leonardo  
Qualità Italia 2015

## Designer e riconoscimenti

Fiam Italia è stata più volte riconosciuta a livello globale come azienda di eccellenza ed innovazione, come dimostrano i numerosi premi ricevuti nel tempo, tra gli altri, il Premio Compasso d'Oro alla carriera ed il Premio Leonardo Qualità Italia.

Il Premio Compasso d'Oro è il più antico e più autorevole premio mondiale di design, istituito nel 1954 da un'idea di Gio Ponti. Fiam lo ha conseguito alla carriera nel 2001, come impresa che si è distinta con riconoscenza e prestigio in ambito progettuale, produttivo e di ricerca. Nel 2015 Il Comitato Leonardo, che da oltre venti anni riconosce e premia il talento di uomini ed imprese per dare rilevanza alle tante straordinarie eccellenze del Made in Italy, ha insignito Fiam del Premio Leonardo Qualità Italia come azienda che si è distinta per innovazione e qualità dei prodotti combinata con una forte proiezione internazionale, commerciale e produttiva.

## Designers et prix

Fiam Italia a été maintes fois reconnue mondialement pour sa vocation à l'innovation et à l'excellence, comme en témoignent les nombreux prix remportés au fil du temps et dont, entre autres, le Prix Compasso d'Oro pour l'ensemble des réalisations et le Prix Leonardo Qualità Italia. Le prix Compasso d'Oro, soit le plus ancien et le plus influent prix international de design, a été créé en 1954 par Gio Ponti. Fiam a remporté le prix pour l'ensemble des réalisations en 2001 en tant qu'entreprise s'étant distinguée dans le domaine de la conception, de la fabrication et de la recherche, se voyant adjudiquer ainsi une des plus prestigieuses marque de reconnaissance du secteur. En 2015, le Comité Leonardo, qui depuis plus de vingt ans, reconnaît et récompense le talent des hommes et des sociétés pour souligner les multiples expressions de l'excellence du Made in Italy, a décerné le Prix Leonardo Qualità Italia à Fiam en tant que une société s'étant distinguée pour son innovation et la qualité exceptionnelle des produits, de son développement commercial et de la fabrication, ainsi que pour son caractère international.

## Designers and awards

Fiam Italia has been repeatedly recognized globally as a company of excellence and innovation, as evidenced by the numerous awards received over time, among them, the Premio Compasso d'Oro (Golden Compass Award) for career and the Premio Leonardo Qualità Italia (Leonardo Award for Quality Italy). The Premio Compasso d'Oro is the oldest and most authoritative global design award, created in 1954 from an idea by Gio Ponti. Fiam has achieved the career award in 2001, as a company that has distinguished itself with gratitude and prestige in design, production, and research. In 2015, the Leonardo Committee, which has been recognizing and awarding the talent of men and companies to give relevance to the many extraordinary excellences of the Made in Italy for more than twenty years, has awarded Fiam with the Premio Leonardo Qualità Italia as a company that has distinguished itself for innovation and quality of products combined with a strong international outlook, for both commerce and production.

## Designer und Preise

Wie die zahlreichen, im Laufe der Zeit von Fiam Italia erhaltenen Preise zeigen, wurde das Unternehmen aufgrund seiner Exzellenz und Innovation mehrfach international ausgezeichnet. Zu den Preisen gehören unter anderem der Preis Compasso d'Oro alla Carriera sowie der Preis Leonardo Qualità Italia. Der Preis Compasso d'Oro ist der älteste und renommierteste Preis für Design weltweit und wurde im Jahr 1954 von Gio Ponti gestiftet. Fiam erhielt diesen Preis nach seiner Erfolge im Jahr 2001 als Unternehmen, das sich durch Anerkennung und Ansehen im Bereich Projektplanung, Produktion und Forschung auszeichnet. Das Komitee Comitato Leonardo, das seit über 20 Jahren das Talent von Menschen und Firmen honoriert und prämiert, um besonders hervorragenden italienischen Produktionen Relevanz zukommen zu lassen, zeichnete Fiam im Jahr 2015 als Unternehmen, das sich durch innovative und qualitativ hochwertige Produkte in Kombination mit einer besonders starken internationalen, kommerziellen und produktiven Position kennzeichnet, mit dem Preis Leonardo Qualità Italia aus.



Archirivolto Design



Aquila Alberg



Bartoli Design



Cini Boeri



Luca Casini



Valerio Cometti



Angelo Cortesi



Marzia e Leo Dainelli



Nicola De Ponti



Fabio Di Bartolomei



Rodolfo Dordoni



Doriana e Massimiliano Fuksas

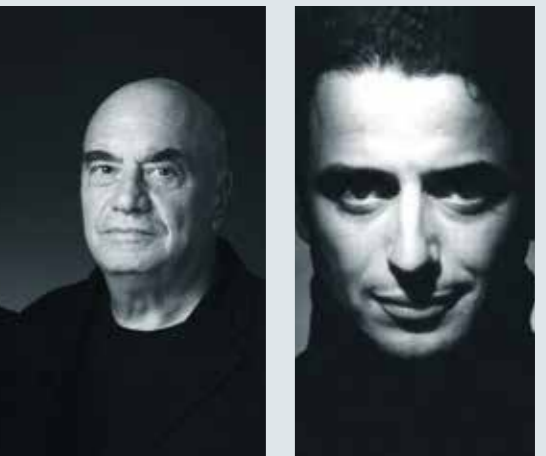

Chafik Gasmî



Massimo Iosa Ghini



Dante O Benini  
e Luca Gonzo



Roberto Giacomucci



Makio Hasuike



Patrick Jouin



studio Klass



Danny Lane



Daniel Libeskind



Luca Lo Bianco



Xavier Lust

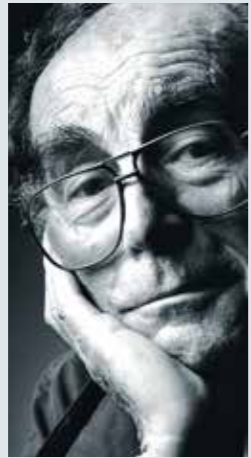

Vico Magistretti



Ilaria Marelli



Enzo Mari



Francesco Mansueto



Massimo Morozzi



Matteo Nunziati



Satyendra Pakhalé



Roberto Paoli



Lucidi Pevere



Christophe Pillet



Prospero Rasulo



Paolo Rizzato



Marta Laudani e Marco Romanelli



Gerussi - Sartoris



Roberto Semprini



Philippe Starck



Enrico Tonucci



Elio Vigna



This Weber



Helidon Xhixha



## Il vetro: un simbolo dell'ecosostenibilità del futuro

Il vetro è natura. È costituito prevalentemente di sabbia e calce. È asettico, atossico e non rilascia alcuna sostanza nociva.

Il vetro è eterno e può essere riciclato all'infinito senza scarto. FIAM Italia valorizza le virtù del vetro attraverso i suoi processi produttivi che si svolgono nel pieno rispetto dell'ambiente.

## Le verre: un symbole de l'avenir du développement durable

Le verre est naturel. Il est essentiellement composé de sable et de chaux.

Il est aseptique, atoxique et ne dégage pas de substance nocive. Le verre est éternel et peut être recyclé à l'infini sans déchet. FIAM Italia valorise les vertus du verre par des procédés de fabrication qui respectent pleinement l'environnement.

## Glass: symbol of an ecosustainable future

Glass is nature. It consists mainly of sand and lime. It is aseptic and non-toxic and does not give off any harmful substances. Glass is eternal and can be recycled indefinitely without generating waste. FIAM Italia exploits the benefits of glass to the full through its environment-friendly production processes.

## Glas – ein Symbol für Nachhaltigkeit, Umweltfreundlichkeit und Zukunft

Glas ist ein Stück Natur. Denn es besteht vorwiegend aus Sand und Kalk.

Es ist keimfrei, ungiftig und gibt keine schädlichen Stoffe ab. Glas hält ewig und kann ohne Rückstände immer wieder recycelt werden. FIAM Italia wertet die Vorteile des Glases dank umweltfreundlicher Produktionsverfahren zusätzlich auf.



# ghost

NON AVREI MAI PENSATO DI FARE UNA POLTRONA IN VETRO...  
LA MIA INIZIALE DIFFIDENZA PER UN'IDEA CHE SEMBRAVA  
IRREALE FU SUPERATA DAL DESIDERIO/SFIDA DI VEDERE  
SE FOSSE POSSIBILE CONCRETIZZARLA; E SE FIAM  
SAREBBE STATA COSÌ BRAVA DA RIUSCIRE A REALIZZARLA.

I WOULD NEVER HAVE THOUGHT OF MAKING A CHAIR FROM GLASS...  
MY INITIAL DISTRUST OF AN IDEA WHICH SEEMED QUITE UNREALISTIC  
WAS OVERCOME BY THE DESIRE TO TAKE UP THE CHALLENGE  
AND SEE WHETHER IT COULD ACTUALLY BE MADE, WHETHER FIAM  
WOULD BE CLEVER ENOUGH TO TRANSFORM THE CONCEPT INTO REALITY.

JE N'AURAI JAMAIS PENSÉ RÉALISER UN JOUR UN FAUTEUIL EN VERRE ...  
MA MÉFIANCE INITIALE À L'ÉGARD D'UNE IDÉE QUI SEMBLAIT IRRÉELLE  
A ÉTÉ SURMONTÉE PAR LE DÉsir/LE DÉFI DE VOIR S'IL ÉTAIT POSSIBLE  
DE LA CONCRÉTISER ET SI FIAM SERAIT À LA HAUTEUR DE LA RÉALISER.

NIE HÄTTE ICH GEDACHT, DASS ICH EINES TAGES EINEN STUHL  
AUS GLAS MACHEN WÜRDE... MEIN ANFÄNGLICHES MISSTRAUEN  
GEGENÜBER EINER IDEE, DIE MIR UNREALISTISCH ERSCIEN,  
WURDE BALD DURCH DEN WUNSCH UND DEN EHRGEIZ VERDRÄNGT,  
ZU SEHEN, OB ICH DIESE IDEE WIRKLICH UMSETZEN KANN UND OB FIAM  
ES SCHAFFEN WÜRDE, DIE VON MIR UMGESETZTE IDEE ZU REALISIEREN.

CINI BOERI



# ghost

DESIGN CINI BOERI

Poltrona in vetro curvato  
da 12 mm.

Monolithic chair  
in 12 mm-thick curved glass.

Fauteuil en verre cintré  
d'une seule dalle  
de verre de 12 mm.

Sessel aus gebogenem  
12 mm-starkem Glas,  
aus einer einzigen  
Glasplatte gefertigt.



admiral	114
caadre	22
caldeira	66
christine	38
dorian	72
hasami	102
hiroshi	106
let me see	116
lucy	78
mary	84
mir	110
mir lampada	112
mirage	118
phantom	46
reverso	126
ritratto	122
rosy	88
the wing	92
venus	58



# SPECCHI MIRRORS MIROIRS SPIEGEL



Specchio quadrato.  
Square mirror.

195 x 13 x 195 cm  
76 3/4" x 5 1/8" x 76 3/4"

Tavolo basso Atlas.  
Atlas coffee table.



Specchio quadrato.  
Square mirror.

195 x 13 x 195 cm  
76 3/4" x 5 1/8" x 76 3/4"

Tavolo Ragno.  
Ragno table.

# caadre

DESIGN PHILIPPE STARCK

Specchio da terra o da parete in vetro da 6 mm formato da quattro elementi singoli curvati (versione neutra) disponibili anche con incisioni decorative (versione incisa) o in vetro semiriflettente color Titanio curvato da 6 mm (versione titanio). Telaio in metallo verniciato grigio metallizzato. Disponibile anche su misura e in configurazioni modulari.

Free-standing mirror, also available in hanging version, in 6 mm-thick curved glass, made of four separate curved elements (neutral version) also available with engravings (engraved version), or semi-reflective glass titanium finishing 6 mm-thick (titanium version). Metal grey-stained frame. Also available custom-sized and in modular configurations.

Miroir appuyant au mur et accrochable encadré par quatre éléments en verre cintré de 6 mm (version neutre), disponibles aussi avec engravures décoratives (version neutre gravée), en verre semi-réfléchissant couleur titane cintré de 6mm (version titane). Cadre en métal vernis gris métallisé. Disponible aussi sur mesure et en configurations modulaires.

Stand- bzw. Wandspiegel aus 6 mm-starkem gebogenem Glas, bestehend aus vier einzelnen Elementen, auch mit Gravüren lieferbar (gravierte Ausführung) oder aus 4 gebogenen halbreflektierenden, Titan-farbigem Glaselementen (Titan Ausführung). Metallrahmen metallgrau lackiert. Auch als Maßanfertigung lieferbar und in Modulen-Ausführungen.

Specchio quadrato, finitura Titanio.  
Square mirror, Titanium finish.

105 x 13 x 105 cm  
41 5/16" x 5 1/8" x 41 5/16"



# caadre

DESIGN PHILIPPE STARCK

Specchio da terra.  
Free-standing mirror.  
105 x 13 x 195 cm  
41 5/16" x 5 1/8" x 76 3/4"





# caadre

DESIGN PHILIPPE STARCK

Specchio da terra.  
Free-standing mirror.

140 x 13 x 195 cm  
55 1/8" x 5 1/8" x 76 3/4"



# caadre

DESIGN PHILIPPE STARCK



Specchio da terra.  
Free-standing mirror.

155 x 13 x 240 cm  
61" x 5 1/8" x 94 1/2"

Tavoli bassi Macramè.  
Macramè coffee tables.

# caadre

DESIGN PHILIPPE STARCK

Specchio rettangolare.  
Versione incisa da parete.  
Rectangular mirror.  
Engraved version.

105 x 13 x 155 cm  
41 5/16" x 5 1/8" x 61"

Vetrina Milo sideboard.  
Milo sideboard showcase.



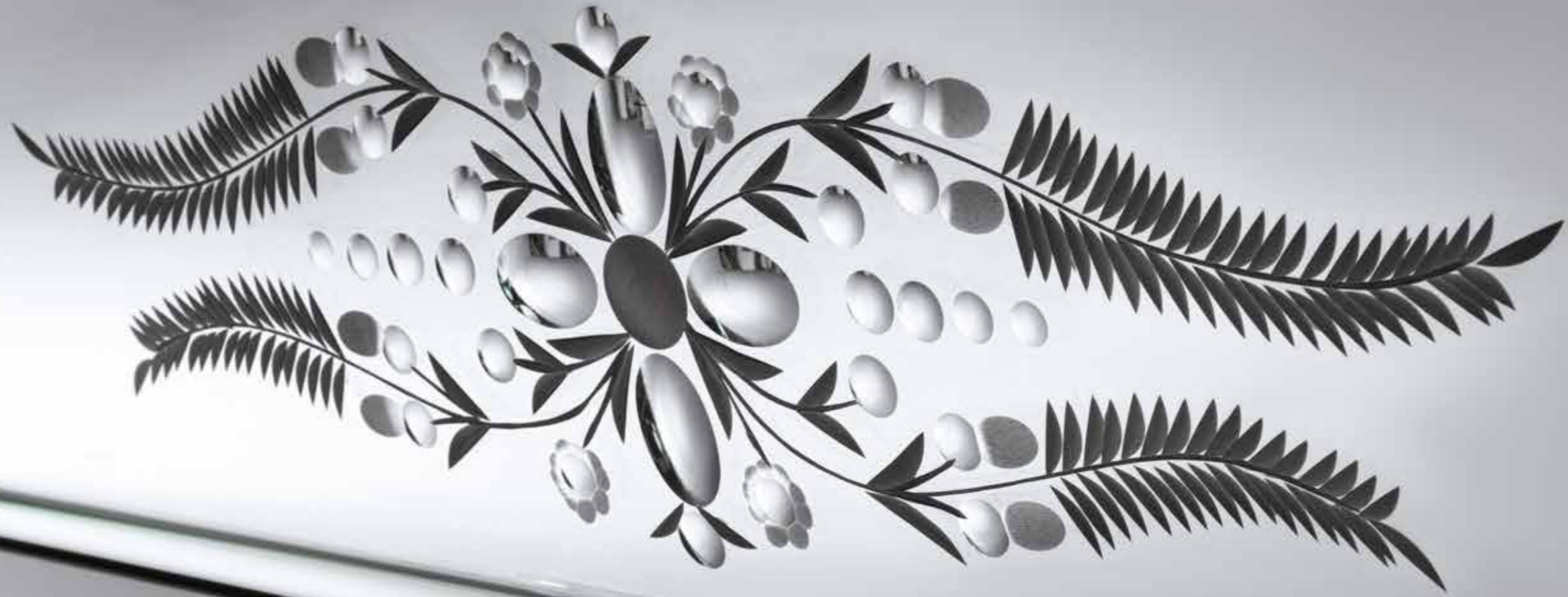



Specchio rettangolare.  
Rectangular mirror.

195 x 23 x 100 cm  
76 3/4" x 9" x 39 3/8"

Tavolo basso Flute.  
Flute coffee table.





Specchio rettangolare.  
Rectangular mirror.  
195 x 23 x 100 cm  
76 3/4" x 9" x 39 3/8"



Specchio quadrato.  
Square mirror.

110 x 23x 110 cm  
43 <sup>5</sup>/<sub>16</sub>" x 9" x 43 <sup>5</sup>/<sub>16</sub>"

Vetrina Milo sideboard.  
Milo sideboard showcase.

## christine

DESIGN HELIDON XHIXHA & DANTE O. BENINI - LUCA GONZO

Specchio da parete  
in vetro fuso da 6 mm  
retro argentato,  
specchio piano da 5 mm.  
Telaio posteriore  
in metallo verniciato.  
Possibilità  
di appendamento  
in diverse posizioni.

Wall mirror in 6 mm  
high temperature  
fused glass,  
back-silvered.  
5 mm flat mirror.  
Rear frame  
in painted metal.  
Can be hung  
in various positions.

Miroir à accrocher  
en verre en fusion  
de 6 mm argenté,  
miroir plat de 5 mm.  
Cadre arrière  
en métal verni.  
Différentes positions  
d'accrochage.

Wandspiegel aus  
geschmolzenem Glas  
versilbert. Flacher  
Spiegel 5 mm stark.  
Hinterer Rahmen  
aus lackiertem Metall.  
Kann in verschiedenen  
Stellungen  
aufgehängt werden.

Specchio quadrato.  
Square mirror.

110 x 23x 110 cm  
43 5/16" x 9" x 43 5/16"

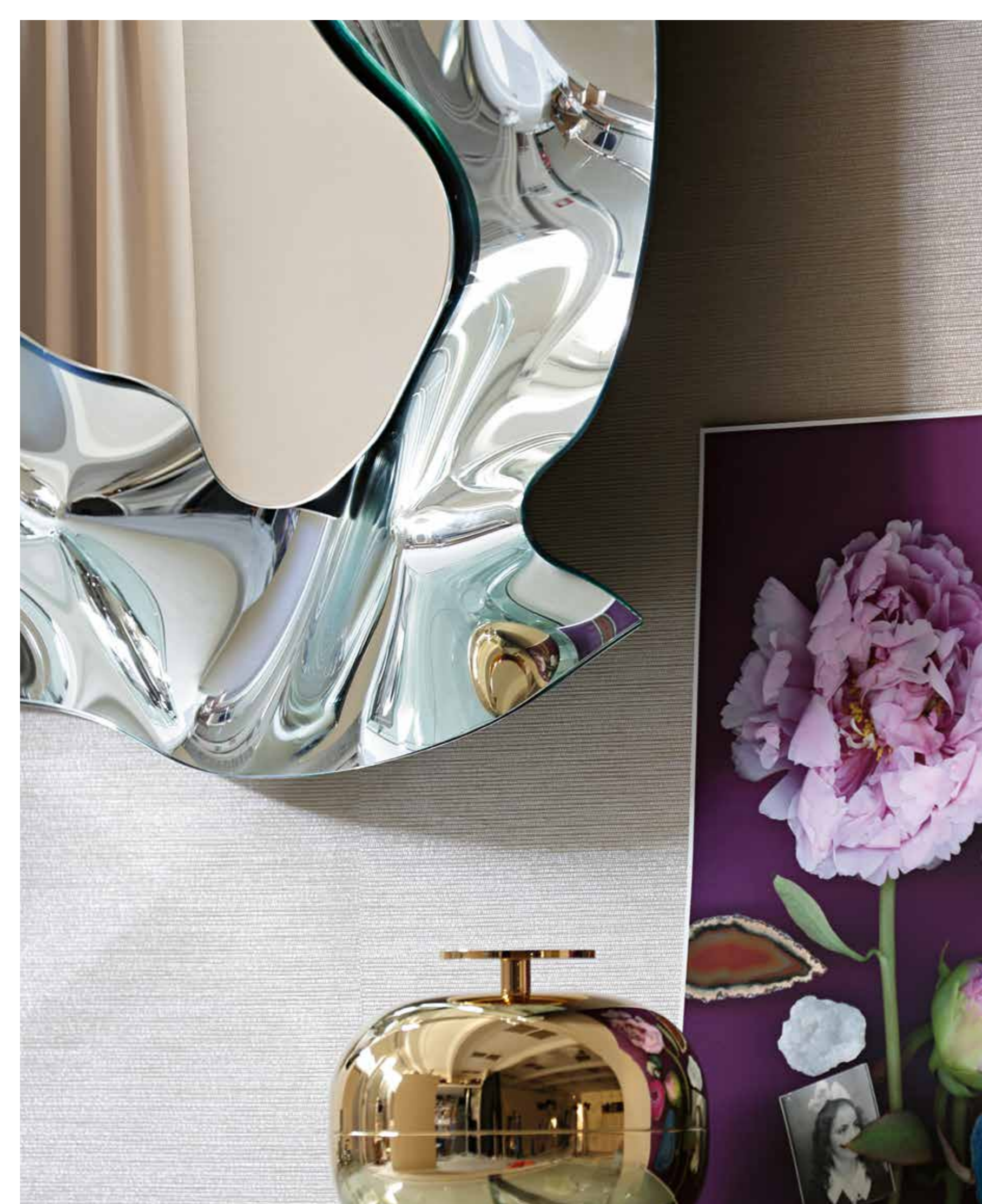



# phantom

DESIGN HELIDON XHIXHA & DANTE O. BENINI - LUCA GONZO



Specchio Ovale.  
Oval mirror.  
180 x 16 x 90 cm  
70 7/8" x 6 5/16" x 35 7/16"

Tavolo LLT.  
LLT table.

# phantom

DESIGN HELIDON XHIXHA & DANTE O. BENINI - LUCA GONZO

Specchio da parete  
in vetro fuso da 6 mm  
retro argentato,  
specchio piano da 5 mm.  
Telaio posteriore  
in metallo verniciato.  
Possibilità di appendimento  
in diverse posizioni.

Wall mirror in 6 mm  
high temperature fused  
glass, back-silvered.  
5 mm flat mirror.  
Rear frame in painted  
metal. Can be hung  
in various positions.

Miroir à accrocher  
en verre en fusion  
de 6 mm argenté,  
miroir plat de 5 mm.  
Cadre arrière en métal  
verni. Différentes  
positions d'accrochage.

Wandspiegel aus  
geschmolzenem  
Glas versilbert.  
Flacher Spiegel 5 mm  
stark. Hinterer Rahmen  
aus lackiertem Metall.  
Kann in verschiedenen  
Stellungen  
aufgehängt werden.

Specchio Ovale.  
Oval mirror.  
180 x 16 x 90 cm  
70 7/8" x 6 5/16" x 35 7/16"

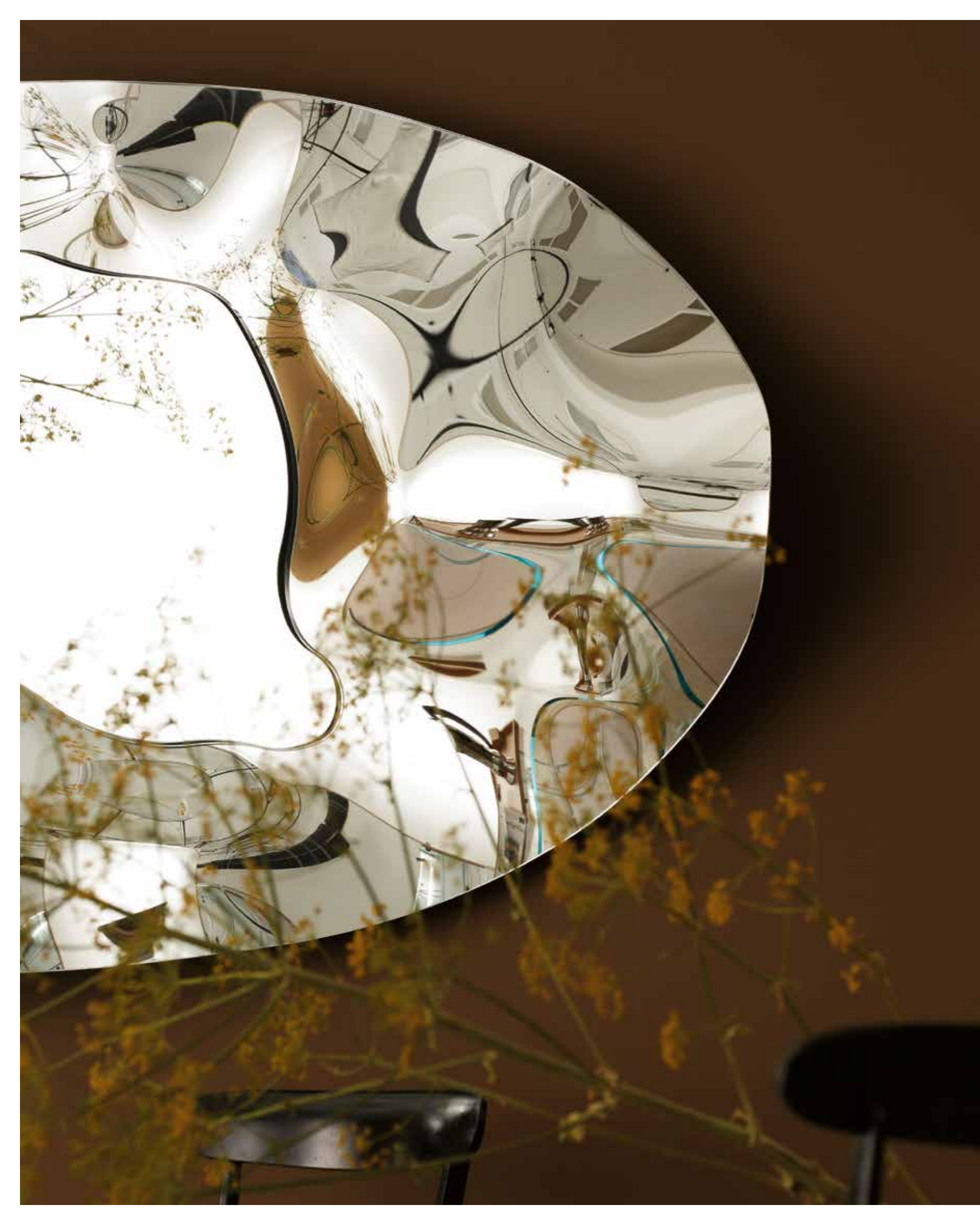



Specchio rettangolare da terra.  
Free-standing rectangular mirror.  
190 x 15 x 90 cm  
76 3/4" x 5 7/8" x 35 7/16"

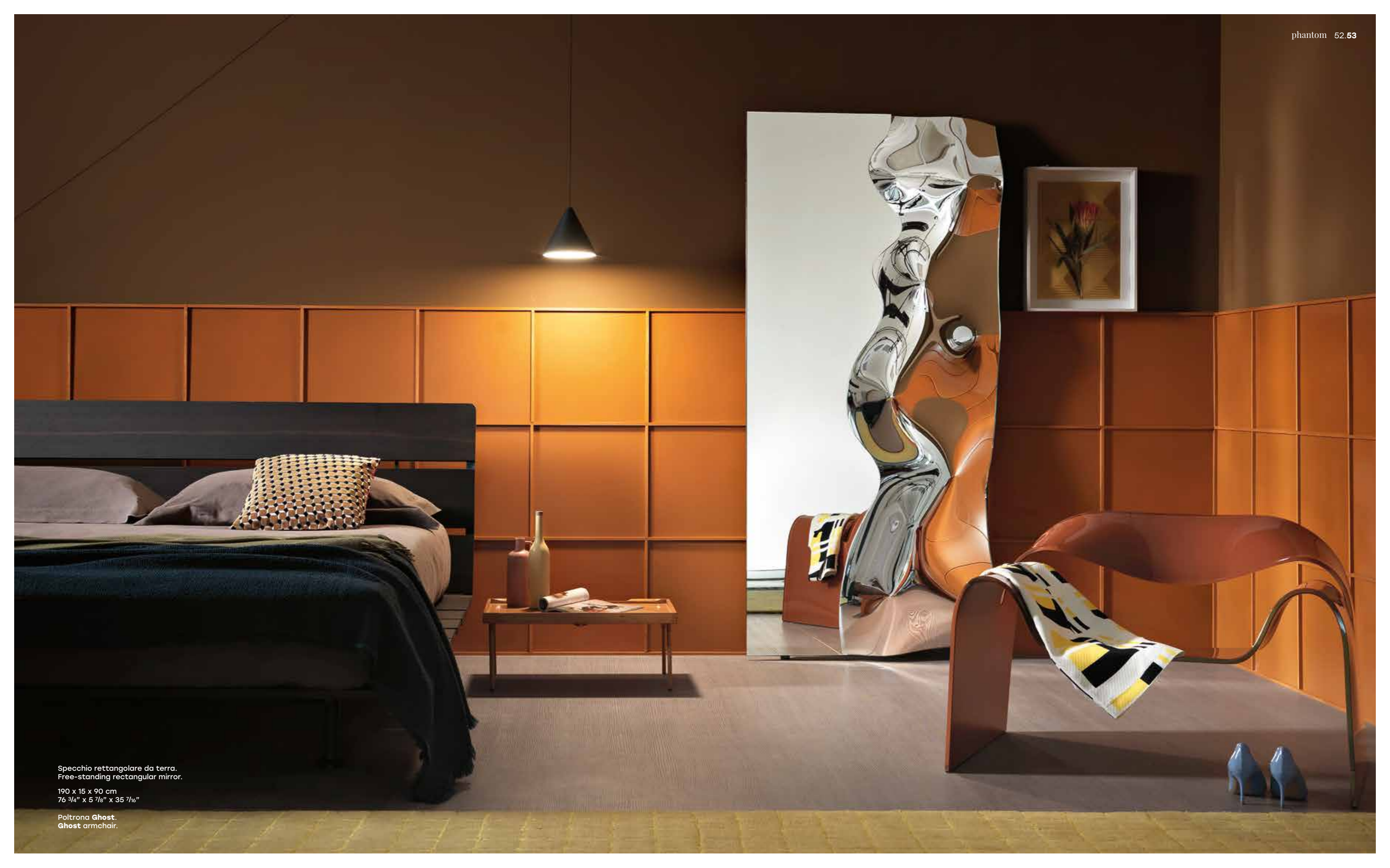

Specchio rettangolare da terra.  
Free-standing rectangular mirror.

190 x 15 x 90 cm  
76 3/4" x 5 7/8" x 35 7/16"

Poltrona Ghost.  
Ghost armchair.



## phantom

DESIGN HELIDON XHIXHA & DANTE O. BENINI - LUCA GONZO

Specchio rettangolare da terra.  
Free-standing rectangular mirror.

190 x 15 x 90 cm  
76 3/4" x 5 7/8" x 35 7/8"



Specchio rettangolare da terra.  
Free-standing rectangular mirror.  
198 x 18 x 98 cm  
78" x 7" x 38 9/16"



# venus

DESIGN VITTORIO LIVI

Collezione di specchi in vetro fuso a gran fuoco da 8 mm retro argentato con decoro artistico a rilievo, specchio piano da 4 mm, telaio posteriore in metallo verniciato.

Collection of mirrors in 8 mm high-temperature fused glass with silvered back. Relief ornamentation on frame, flat mirror 4 mm thick, painted metal rear frame.

Collection de miroirs en verre en fusion de 8 mm arrière argenté avec décoration artistique en relief, miroir plat de 4 mm, cadre arrière en métal verni.

Kollektion von Spiegeln aus bei sehr hohen Temperaturen geschmolzenem, 8 mm starkem, hinten versilbertem Glas, mit edlem Reliefdekor. Flacher Spiegel, 4 mm Stärke. Rückwärtiger Rahmen aus Metall.

Specchio rettangolare.  
Rectangular mirror.

200 x 105 cm  
78 3/4" x 42 5/16"

Tavolino Rialto tris.  
Rialto tris coffee table.





Specchio rettangolare.  
Rectangular mirror.

200 x 71 cm  
78 3/4" x 27 9/16"





# venus

DESIGN VITTORIO LIVI



Specchio rettangolare da terra.  
Free-standing rectangular mirror.

200 x 105 cm  
78 3/4" x 42 5/16"

Portariviste Vogue.  
Vogue magazine rack.



Specchio rotondo.  
Round mirror.  
ø 126 cm  
49 8/16"



# caldeira

DESIGN XAVIER LUST



Specchio ellittico.  
Elliptical mirror.

104 x 5 x 235 cm  
41" x 2" x 92 1/2"

Tavolino Rialto tris.  
Rialto tris coffee table.

# caldeira

DESIGN XAVIER LUST

Specchio da parete  
in vetro fuso a gran fuoco  
da 8 mm retroargentato  
con decoro artistico  
a rilievo, specchio piano  
da 5 mm. Telaio posteriore  
in metallo verniciato.  
Possibilità di appendimento  
in diverse posizioni.

Wall mirror in 8 mm  
high-temperature  
fused glass with back  
silvered with artistic  
relief ornamentation  
5 mm flat mirror.  
Varnished metal back  
frame. Can be hung  
in various positions.

Miroir à accrocher  
en verre en fusion  
au grand feu de 8 mm  
argenté avec décoration  
artistique en relief,  
miroir plat de 5 mm.  
Cadre arrière en métal  
peint. Différentes  
positions d'accrochage.

Wandspiegel aus 8 mm  
starkem, geschmolzenem  
Glas, versilbert,  
mit künstlerischem Relief  
Dekor, flacher Spiegel 5 mm  
stark. Hinterer Rahmen  
aus lackiertem Metall.  
Kann in verschiedenen  
Stellungen  
aufgehängt werden.

Specchio rotondo.  
Round mirror.  
105 x 5 x 112 cm  
41 5/16" x 2" x 44 1/8"



# caldeira

DESIGN XAVIER LUST



Specchio rotondo.  
Round mirror.  
105 x 5 x 112 cm  
41 5/16" x 2" x 44 1/8"

# dorian

DESIGN MASSIMO IOSA GHINI

Specchio con cornice  
in vetro fuso a gran fuoco  
da 6 mm retroargentato;  
specchio piano da 5 mm.  
Telaio posteriore in metallo  
verniciato. Possibilità  
di appendimento  
verticale od orizzontale.

Wall mirror in 6 mm  
high temperature  
fused glass,  
back-silvered;  
5 mm flat mirror.  
Rear frame in painted  
metal. It can be hung  
horizontally or vertically.

Miroir à accrocher  
en verre en fusion  
de 6 mm argenté;  
miroir plat de 5 mm.  
Cadre arrière en  
métal verni. Possibilité  
d'accrochage  
en horizontal ou vertical.

Wandspiegel aus  
geschmolzenem  
Glas versilbert; flacher  
Spiegel 5 mm stark. Hinterer  
Rahmen aus lackiertem  
Metall. Kann sowohl  
horizontal als auch vertikal  
aufgehängt werden.

Specchio rettangolare da terra.  
Free-standing rectangular mirror.

202 x 10 x 105 cm  
79 1/2" x 4" x 41 5/16"



# dorian

DESIGN MASSIMO IOSA GHINI

Specchio rettangolare da terra.  
Free-standing rectangular mirror.

202 x 10 x 105 cm  
79 1/2" x 4" x 41 5/16"



# dorian

DESIGN MASSIMO IOSA GHINI

Specchio rettangolare.  
Rectangular mirror.

120 x 7 x 80 cm  
47 1/4" x 2 3/4" x 31 1/2"





# lucy

DESIGN DORIANA E MASSILIANO FUKSAS

Specchio da parete.  
Wall mirror.

153 x 10 x 117 cm  
60 1/4" x 4" x 46"

Consolle Rialto  
Rialto console



# lucy

DESIGN DORIANA E MASSIMILIANO FUKSAS



Specchio da parete.  
Wall mirror.

153 x 10 x 117 cm  
60 1/4" x 4" x 46"

Consolle LLT.  
LLT console.

# lucy

DESIGN DORIANA E MASSIMILIANO FUKSAS

Specchio da parete  
in vetro fuso da 8 mm  
retroargentato,  
specchio piano da 5 mm.  
Pannello di fissaggio  
posteriore con possibilità  
di appendimento  
in diverse posizioni.

Wall mirror in 8 mm  
fused glass back  
silvered;  
5 mm flat mirror.  
Rear mounting panel  
allowing hanging  
in various positions.

Miroir à accrocher  
en verre en fusion  
de 8 mm argenté,  
miroir plat de 5 mm.  
Panneau de fixation  
arrière avec  
différentes positions  
d'accrochage.

Wandspiegel aus 8 mm  
starkem, geschmolzenem  
Glas versilbert,  
flacher Spiegel 5 mm.  
An der Rückseite  
Montageplatte  
zum Aufhängen in  
verschiedenen Stellungen.

Specchio da parete.  
Wall mirror.

153 x 10 x 117 cm  
60 1/4" x 4" x 46"

Consolle LLT.  
LLT console.



# mary

DESIGN DORIANA E MASSIMILIANO FUKSAS

Specchio da parete  
in vetro fuso da 8 mm  
retroargentato,  
specchio piano da 5 mm.  
Pannello di fissaggio  
posteriore con possibilità  
di appendimento  
in diverse posizioni.

Wall mirror in 8 mm  
fused glass back silvered;  
5 mm flat mirror.  
Rear mounting panel  
allowing hanging  
in various positions.

Miroir à accrocher  
en verre en fusion  
de 8 mm argenté,  
miroir plat de 5 mm.  
Panneau de fixation  
arrière avec différentes  
positions d'accrochage.

Wandspiegel aus 8 mm  
starkem, geschmolzenem  
Glas versilbert, flacher  
Spiegel 5 mm. An der  
Rückseite Montageplatte  
zum Aufhängen in  
verschiedenen Stellungen.

Specchio ovale.  
Oval mirror.

120 x 10 x 180 cm  
47 1/4" x 4" x 70 7/8"

Comodino Charlotte de nuit.  
Charlotte de nuit bedside table.



mary

DESIGN DORIANA E MASSIMILIANO FUKSAS

Specchio ovale.  
Oval mirror.

120 x 10 x 180 cm  
47 1/4" x 4" x 70 7/8"

Comodino Charlotte de nuit.  
Charlotte de nuit bedside table.



**rosy**

DESIGN DORIANA E MASSIMILIANO FUKSAS

Specchio rotondo.  
Round mirror.

Ø 100 x 10 cm  
Ø 39 3/8" x 4"  
Ø 130 x 10 cm  
Ø 51 3/16" x 4"

Poltrona Ghost.  
Ghost armchair.

Collezione di tavolini Rialto tris.  
Rialto tris collection of side tables.



# rosy

DESIGN DORIANA E MASSIMILIANO FUKSAS

Specchio da parete  
in vetro fuso da 8 mm  
retroargentato,  
specchio piano da 5 mm.  
Pannello di fissaggio  
posteriore con possibilità  
di appendimento  
in diverse posizioni.

Wall mirror in 8 mm  
fused glass back silvered;  
5 mm flat mirror.  
Rear mounting panel  
allowing hanging  
in various positions.

Miroir à accrocher  
en verre en fusion  
de 8 mm argenté,  
miroir plat de 5 mm.  
Panneau de fixation  
arrière avec différentes  
positions d'accrochage.

Wandspiegel aus 8 mm  
starkem, geschmolzenem  
Glas versilbert, flacher  
Spiegel 5 mm. An der  
Rückseite Montageplatte  
zum Aufhängen in  
verschiedenen Stellungen.

Specchio rotondo.  
Round mirror.

ø 100 x 10 cm  
ø 39 3/8" x 4"

Tavolino Rialto tris.  
Rialto tris side table.





## the wing

DESIGN DANIEL LIBESKIND

Specchio rettangolare con angolo.  
Rectangular mirror with corner.

200 x 10 x 53 cm  
78 3/4" x 4" x 20 7/8"

Tavo basso Macramé.  
Macramé coffee table.



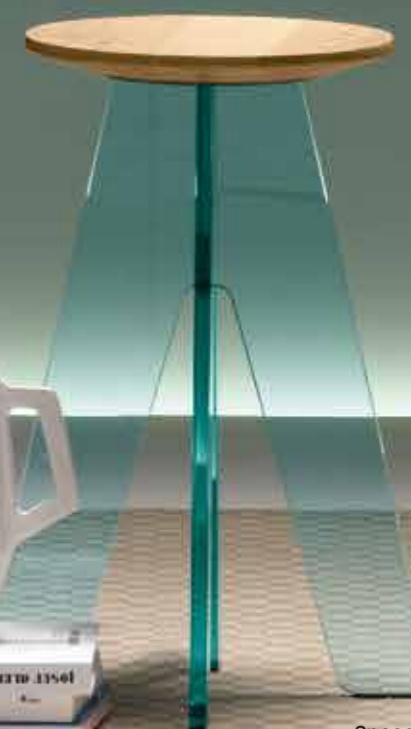
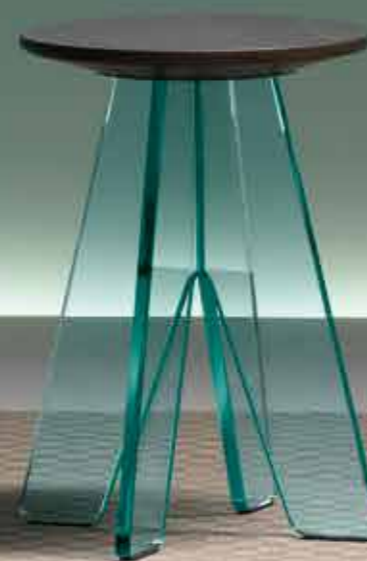

Specchio rettangolare con angolo.  
Rectangular mirror with corner.

200 x 10 x 53 cm  
78 3/4" x 4" x 20 7/8"

## the wing

DESIGN DANIEL LIBESKIND

Specchio da parete  
composto da due  
elementi in vetro curvato  
retroargentato da 6 mm  
e da tre specchi piani  
da 6 mm saldati tra loro.  
Telaio posteriore  
in metallo con possibilità  
di appendimento  
in orizzontale,  
verticale ed obliquo.

Wall mirror consisting  
of two 6 mm curved  
back-silvered glass elements  
and three flat mirrors  
of 6 mm welded together.  
Metal back frame allowing  
horizontal, vertical  
and slanted hanging.

Miroir à accrocher constitué  
de deux éléments en verre  
cintré argenté de 6 mm  
et de trois miroirs plats  
de 6 mm soudés entre eux.  
Cadre arrière en métal  
pour accrochage horizontal,  
vertical ou oblique.

Wandspiegel aus zwei  
6 mm starken, gebogenen  
Glaselementen versilbert  
und drei 6 mm starken,  
miteinander verschweißten  
Flachspiegeln. An der  
Rückseite ein Metallrahmen  
zum Aufhängen  
in waagrechter, senkrechter  
und schräger Stellung.

Specchio rettangolare con angolo.  
Rectangular mirror with corner.

200 x 10 x 53 cm  
78 3/4" x 4" x 20 7/8"





Specchio ellittico.  
Elliptical mirror.  
180 x 10 x 65 cm  
70 7/8" x 4" x 25 9/16"  
Vetrina Milo sideboard.  
Milo sideboard showcase.

the wing  
DESIGN DANIEL LIBESKIND

Specchio ellittico.  
Elliptical mirror.  
180 x 10 x 65 cm  
70 7/8" x 4" x 25 9/16"



# hasami

DESIGN PAOLO RIZZATTO

Specchio da parete  
in vetro curvato  
argentato da 6 mm  
orientabile tramite  
snodo posteriore  
in acciaio inox.

Wall mirror in 6 mm-thick  
curved silver-backed glass.  
The articulated rear  
joint in stainless steel  
allows the mirror to be  
angled as preferred.

Miroir accrochable  
en verre cintré de 6 mm.  
Le joint postérieur  
en acier inox permet  
un positionnement  
personnalisé.

Wandspiegel aus  
6 mm-starkem  
gebogenem Glas.  
Der an der Rückseite  
angebrachte Mechanismus  
aus rostfreiem Stahl  
ermöglicht eine individuelle  
Ausrichtung und Befestigung.

Specchio quadrato.  
Square mirror.

90 x 18 x 90 cm  
35 7/16" x 7 1/16" x 35 7/16"





# hasami

DESIGN PAOLO RIZZATTO

Specchio rotondo.  
Round mirror.

Ø 96 x 17 cm  
37 3/4" x 6 11/16"



# hiroshi

DESIGN MARTA LAUDANI, ROBERTO ROMANELLI

Specchio da parete  
in vetro curvato  
da 6 mm. Il telaio  
metallico posteriore  
consente il fissaggio  
a scelta su ogni lato.

Wall mirror in 6 mm-thick  
curved silver-backed  
glass. The back metal  
frame allows any  
positioning on any side.

Miroir accrochable  
en verre cintré  
de 6 mm. Le cadre  
postérieur en métal  
permet de choisir  
le positionnement  
sur tous côtés.

Wandspiegel  
aus 6 mm-starkem  
gebogenem Glas.  
Der hintere Metallrahmen  
ermöglicht eine  
freie Wahl der  
Wandbefestigung.

Specchio rettangolare.  
Rectangular mirror.  
180 x 8 x 55 cm  
70 3/8" x 3 1/8" x 39 3/8"



# hiroshi

DESIGN MARTA LAUDANI, ROBERTO ROMANELLI

Specchio quadrato.  
Square mirror.  
100 x 8 x 100 cm  
39 3/8" x 3 1/8" x 39 3/8"





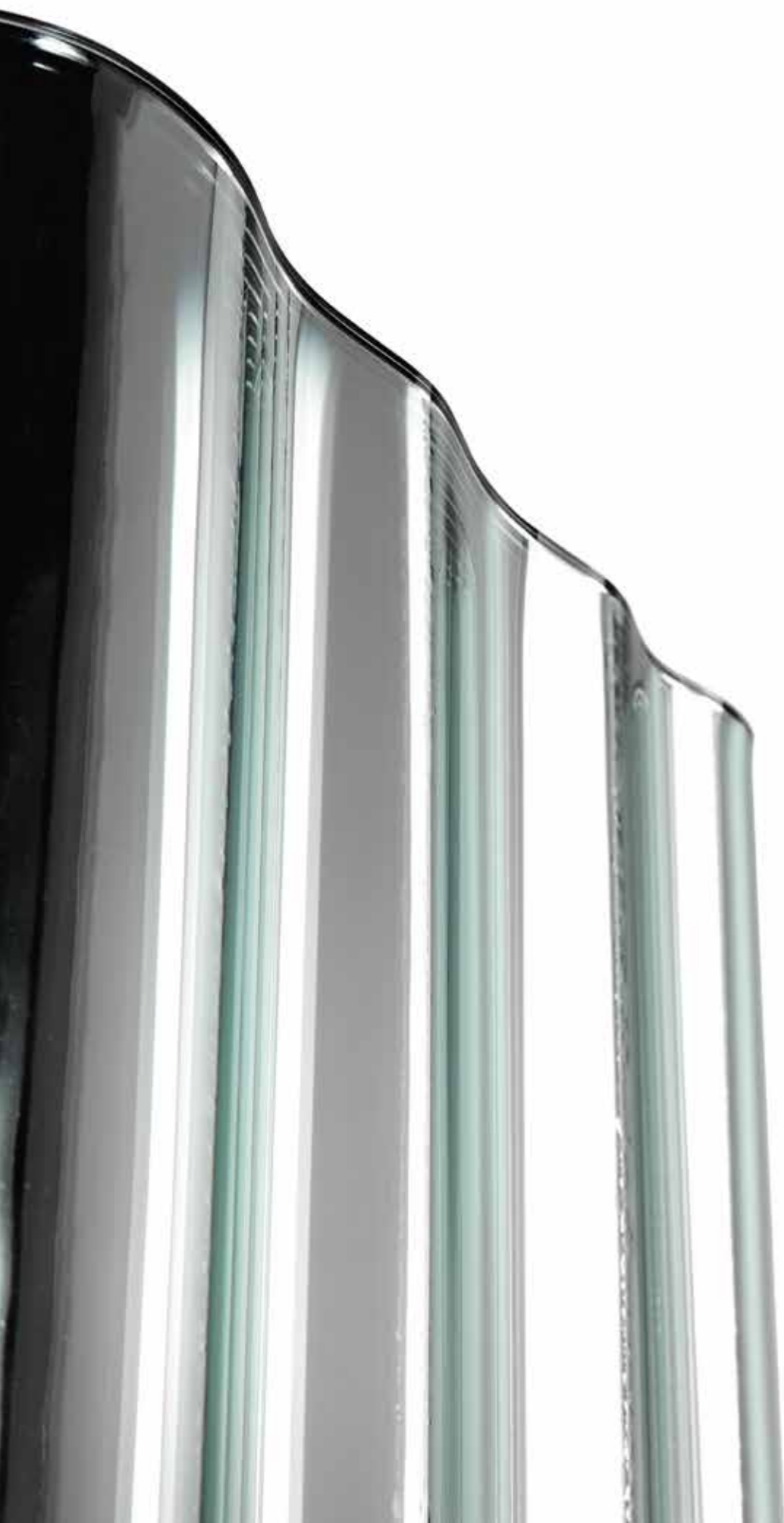

## mir

DESIGN ROBERTO PAOLI

Specchio da terra girevole,  
con scocca in vetro curvato  
a gran fuoco argentato da 6 mm,  
telaio interno in acciaio verniciato,  
base a specchio da 8 mm saldata  
su piatto in acciaio verniciato.

Free-standing rotating mirror  
consisting in a 6 mm-thick  
curved mirrored-glass frame,  
internally supported by a lacquered  
steel structure, base composed  
of a 8 mm-thick mirror jointed  
to a lacquered steel plate.

Miroir au sol tournant en verre  
cintré en fusion de 6 mm;  
cadre intérieur supportant  
en acier verni; base en miroir  
de 8 mm soudée sur plat en acier.

Drehbarer Standspiegel  
aus 6 mm-starkem, bei hohen  
Temperaturen geschmolzenem  
Glas. Innere stützende Struktur  
aus gebeiztem Stahl.  
Spiegel Basis, 8 mm stark,  
verschweißt auf einem Stahlplatte.

Specchio da terra girevole.  
Free-standing revolving mirror.

Ø 53 x 198 cm  
Ø 20 7/8" x 77 15/16"

Collezione di tavolini **Rialto tris**.  
**Rialto tris** collection of side tables.



## mir lampada

DESIGN ROBERTO PAOLI

Specchio-lampada da terra girevole con scocca in vetro curvato a gran fuoco argentato da 6 mm. Telaio interno in acciaio verniciato, base a specchio da 8 mm saldata su piatto in acciaio verniciato. Provvisto di kit illuminazione interna.

Revolving mirror-standing lamp with 6 mm high temperature curved silvered glass frame. Inside supporting mount in painted steel, base composed of a 8 mm thick mirror jointed to a lacquered steel plate. Lighting kit inside.

Miroir-lampadaire pivotant avec coque en verre cintré en fusion argenté de 6 mm. Cadre interne en acier verni, base en miroir de 8 mm soudée sur plat en acier. Kit éclairage interne.

Drehbares Spiegel-Stehlampenelement mit bei sehr hohen Temperaturen versilberter, 6 mm starker gebogener Glas. Spiegel Basis, 8 mm stark, verschweißt auf einem Stahlplatte. Integrierter Beleuchtung.

Specchio-lampada da terra.  
Revolving mirror-standing lamp.

Ø 53 x 198 cm  
Ø 20 7/8" x 77 15/16"





## admiral

DESIGN FABIO DI BARTOLOMEI

Specchio bifacciale  
in vetro curvato  
da 12 mm con base  
a calotta sferica  
rivestito in ABS  
nero goffrato.

Double-sided mirror  
with 12 mm-thick  
glass casted  
to a spherical cap base,  
black ABS coated.

Miroir biface en verre  
cintré de 12 mm ancré  
à un piétement  
à calotte sphérique  
en ABS couleur  
noire gaufrée.

Doppelseitiger Spiegel  
aus 12 mm-starkem  
gebogenem Glas  
mit kugelkappenförmiger  
Basis, mit ABS-Kunststoff  
beschichtet  
und schwarz geprägt.

Specchio bifacciale.  
Double-sided mirror.

40 x 37 x 187 cm  
15 3/4" x 14 9/16" x 73 5/8"

# let me see

DESIGN RODOLFO DORDONI

Specchio consolle  
con ripiano in vetro  
curvato da 8 mm.  
Cornice in acciaio  
inox satinato.

Mirror console  
in 8 mm-thick  
curved glass.  
Frame in glazed  
stainless steel.

Miroir console  
avec étagère  
en verre cintré  
de 8 mm.  
Cadre en acier  
inox satiné.

Spiegel Konsole mit  
Ablage aus 8 mm-starkem  
gebogenem Glas.  
Rahmen aus rostfreiem  
satinierem Stahl.



Specchio consolle.  
Mirror console.  
120 x 36 x 195 cm  
47 1/4" x 14 3/16" x 76 3/4"



# mirage

DESIGN DANIEL LIBESKIND

Specchio da parete con cornice in alluminio finitura brill. Lo specchio offre sia un'ampia gamma di misure che un'ampia possibilità di customizzazione.

Wall mirror with brill finish aluminium frame. The mirror is available in a wide range of sizes and offers several customization solutions.

Miroir à accrocher avec cadre en aluminium finition brill. Le miroir offre un vaste assortiment de mesures et une large gamme de personnalisation.

Wandspiegel mit Rahmen Finish geglänztes Aluminium. In vielen verschiedenen Größen und Personalisierungen.

Composizione di specchi quadrati e rettangolari. Square and rectangular mirrors composition.

70 x 5 x 70 cm  
27 9/16" x 2" x 27 9/16"

160 x 5 x 50 cm  
62" x 2" x 19 1/16"

200 x 5 x 60 cm  
78 3/4" x 2" x 23 8/8"





Composizione di specchi sagomati.  
Shaped mirrors composition.  
mod.A + mod.B + mod.C + mod.D

# ritratto

DESIGN MARTA LAUDANI, MARCO ROMANELLI

Specchio da parete con cornice in legno applicata direttamente sulla superficie specchiante. La cornice in stile barocco, può essere singola tonda o doppia ellittica, finiture oro ed argento.

Wall mirror with wooden frame mounted directly on the mirror surface. Available with one round frame or double elliptical, Baroque style, gold and silver finishes.

Miroir à accrocher avec cadre en bois appliqué directement sur le miroir. Le cadre style baroque est disponible rond dans les finitions or et argent, ou double elliptique dans les mêmes finitions.

Wandspiegel mit direkt auf der Spiegelfläche angebrachtem Holzrahmen. Mit rundem Rahmen oder mit doppeltem elliptischem Rahmen, Barockstil, Finish Gold oder Silber.

Specchio rettangolare con doppia cornice ellittica 55 x 48 cm.  
Rectangular mirror with double elliptical frame 55 x 48 cm.

150 x 5 x 70 cm  
59" x 2" x 27 9/16"



## ritratto

DESIGN MARTA LAUDANI & MARCO ROMANELLI

Specchio quadrato con cornice  
tonda diam. 60 cm.  
Square mirror with round  
frame diam. 60 cm.

110 x 5 x 110 cm  
43 5/16" x 2" x 43 5/16"





# reverso

DESIGN MARZIA E LEO DAINELLI

Specchio da parete in vetro saldato da 6 mm con elemento centrale in vetro Nero95. L'inclinazione delle superfici dello specchio permette una riflessione del soggetto specchiato secondo più punti di vista.

Wall mirror in 6 mm welded glass with Black95 glass central element. The angle of the mirror's surfaces reflects the object from several points of view.

Miroir à accrocher en verre soudé de 6 mm avec élément central en verre Noir95. L'inclinaison des surfaces du miroir permet une réflexion du sujet sous différents angles de vue.

Wand-Spiegel aus 6 mm starkem Glas mit Inlay aus Glas Schwarz95. Durch die unterschiedliche Neigung der einzelnen Flächen kann das Spiegelbild aus unterschiedlichen Perspektiven betrachtet werden.

Specchio da parete.  
Wall mirror.

180 x 16 x 70 cm  
70 7/8" x 6 5/16" x 27 9/16"



caadre tv  
mirage tv

130  
134



SPECCHI TV  
MIRRORS-TV  
MIROIRS-TV  
TV-SPIEGEL



Specchio con TV incorporata 55"  
Mirror with built-in TV 55"

195 x 20 x 140 cm  
76 3/4" x 7 7/8" x 55 1/8"

# caadre tv

DESIGN PHILIPPE STARCK

Specchio con televisore incorporato. Specchio da parete in vetro semiriflettente da 5 mm color titanio, formato da 4 elementi singoli curvati in vetro semiriflettente da 6 mm color titanio e retroverniciato nero. Telaio in metallo verniciato nero opaco.

Mirror with integral television. Wall mirror in 5 mm semi-reflective glass, titanium colour made of 4 separate curved elements in 6 mm semi-reflective glass titanium colour, backpainted black. Metal frame painted matt black.

Miroir avec poste TV incorporé. Miroir accrochable en verre semi-réfléchissant de 5 mm couleur titane formé de 4 éléments séparés cintrés en verre semi-réfléchissant de 6 mm couleur titane et peint dessous noir. Structure en métal peint noir mat.

Spiegel mit eingebautem TV-Gerät. Wandspiegel aus halbreflektierendem, 5 mm starkem Glas in der Farbe Titan, gebildet aus 4 einzelnen gebogenen Elementen mit halbreflektierendem, 6 mm starkem Glas in der Farbe Titan, rückseitig schwarz lackiert. Der Rahmen ist aus Metall und mit Schwarz matt lackiert.

Specchio con TV incorporata 42".  
Mirror with built-in TV 42".

155 x 20 x 140 cm  
61" x 7 7/8" x 55 1/8"





Specchio per TV 42".  
42" TV mirror.

160 x 10 x 90 cm  
62" x 4" x 35 7/16"

Tavolo basso **Quadra**.  
**Quadra** coffee table.

# mirage TV

DESIGN DANIEL LIBESKIND

Specchio con alloggiamento per televisore.  
Specchio da parete in vetro semiriflettente da 5mm color titanio con retrocornice in alluminio finitura brill.  
Telaio in metallo verniciato nero opaco.  
Televisore non in dotazione.

Mirror with built-in frame to accommodate a TV set.  
Wall mirror in 5 mm semi-reflecting glass, titanium-colour, with rear frame in polished aluminium.  
Casing in matt black painted metal.  
TV set not included.

Miroir avec poste pour téléviseur. Miroir à accrocher en verre semi-réfléchissant de 5mm couleur titane avec cadre arrière en aluminium finition brillante. Cadre en métal verni noir mat.  
Téléviseur non fourni.

Spiegel zur eingebautem Fernseher vorbereitet.  
Wandspiegel aus halbreflektierendem Glas von 5 mm Stärke, titanfarben, Rückseite aus Aluminium Hochglanzfinish, matt schwarz lackierter Metallrahmen.  
Der Fernseher wird nicht mitgeliefert

Specchio per TV 42".  
42" TV mirror.

160 x 10 x 90 cm  
62" x 4" x 35 7/16"



# mirage tv

DESIGN DANIEL LIBESKIND

Specchio per TV 42".  
42" TV mirror.

160 x 10 x 90 cm  
62" x 4" x 35 7/16"

Tavolo basso **Quadra**.  
**Quadra** coffee table.



aura	166
babele	178
magique totem	182
milo day	160
milo day led	164
milo sideboard	156
palladio	170
palladio uno	176
plié	142
varesina	148

ESPOSITORI,  
VETRINE, CONTENITORI

SHOWCASES,  
DISPLAY UNITS,  
CONTAINER CABINETS

PRÉSENTOIRS,  
VITRINES, MEUBLES  
DE RANGEMENT

REGALE, VITRINE,  
KASTEN





Madia, finitura grigio polvere.  
Cupbbpard, dust grey finish.  
121 x 47 x 163 cm  
47 5/8" x 18 1/2" x 64 1/8"

# plié

DESIGN STUDIO KLASS

Madia composta da schienale in vetro Nero95 curvato da 8 mm, top in vetro fumè da 10 mm, ante in vetro extralight curvato da 6 mm parzialmente retroverniciate, 2 ripiani in vetro extralight da 8 mm di cui uno retroverniciato, base in legno laccato nero opaco, piedini, montanti e profili in metallo laccato nero opaco. Ante con meccanismo di apertura push-pull. Corpo illuminante a LED opzionale.

Cupboard consisting of back in curved 8 mm Nero95 black glass, top in 10 mm smoked glass, doors in 6 mm curved extralight glass, partially back-painted, 2 shelves in 8 mm extralight glass, of which one back-painted, base in matt black lacquered wood, feet, uprights and profiles in matt black lacquered metal. Doors with push-pull closing mechanism. Lighting with LEDs, as an option.

Buffet composé d'un panneau en verre noir (Nero95) cintré de 8 mm, top en verre fumé de 10 mm, porte en verre extralight cintré de 6 mm partiellement verni dessous, 2 étagères en verre extralight de 8 mm dont une vernis dessous, base en bois laqué noir opaque, pieds, montants et profils en métal laqué noir opaque. Portes avec mécanisme ouverture push-pull. Eclairage à LED en option.

Kasten mit Rückwand aus 8 mm Schwarzem (Nero95) Glas, Deckplatte aus 10 mm Rauchglas, Türen aus 6 mm gebogenem Extralight Glas mit Teilhinterlackierung, 2 Einlegeböden aus 8 mm Extralight Glas, von denen einer lackiert ist, Basiselement aus mattschwarz lackiertem Holz. Füßchen, Streben und Profile aus mattschwarz lackiertem Metall. Türen mit Push-Pull-Mechanismus. LED-Beleuchtung auf Wunsch.



Madia, finitura marrone-grey.  
Cupboard, brown-grey finish.

121 x 47 x 163 cm  
47 5/8" x 18 1/2" x 64 1/8"

Collezione Plié (tavolo, madia, sedia).  
Plié collection (table, cupboard, chair).



# plié

DESIGN STUDIO KLASS



Madia, finitura grigio polvere.  
Cupboard, dust grey finish.  
121 x 47 x 163 cm  
47 5/8" x 18 1/2" x 64 1/8"



Madia, finitura Avorio.  
Cupboard, Ivory finish.  
240 x 50 x 72 cm  
94 1/2" x 19 1/16" x 28 3/8"  
Specchio Dorian.  
Dorian mirror.

# varesina

DESIGN MATTEO NUNZIATI

Madia composta da elementi in vetro extralight o fumè curvato da 12 mm associati ad elementi contenitori chiusi, con ante a ribalta, in legno ricoperto da vetro "Skinglass" da 6 mm, smaltato a gran fuoco con finitura effetto tessuto, disponibile in tre varianti cromatiche: avorio, grafite o moka. Base in vetro extralight o fumè da 12 mm, piedini in vetro extralight o fumè da 15 mm.

Cupboard consisting of 12 mm extralight or smoked curved glass elements combined with closed container elements, with turnover doors, in wood covered with 6 mm "Skinglass", enamelled at high temperature with fabric-effect finish, available in three colours: ivory, graphite or moka. Base in 12 mm extralight or smoked glass, feet in 15 mm extralight or smoked glass.

Buffet composé d'éléments en verre extralight ou fumé cintré de 12 mm, associés à des éléments de rangement fermés, avec portes à bascule, en bois recouvert de verre "Skinglass" de 6 mm, émaillé à haute température avec finition effet tissu, disponibles dans trois versions chromatiques: ivoire, graphite, moka. Base en verre extralight ou fumé de 12 mm, pieds en verre extralight ou fumé de 15 mm.

Sideboard aus gebogenem 12 mm Extralight oder Rauchglas. Geschlossene Container-Elemente mit Klapptüren. Holzstruktur mit "Skinglass" Beschichtung, d.h. mit hohen Temperaturen behandelt Glas und Keramiksiebdruck um eine textile Optik und Haptik zu erhalten. Drei Variante: elfenbein-, graphitgrau- und mokabraun- Farbe. 12 mm extralight-Glas oder Rauchglasbasis, extralight-Glas oder Rauchglas Füßchen.



Madia, finitura Moka.  
Cupboard, Moka finish.  
240 x 50 x 72 cm  
94 1/2" x 19 1/16" x 28 3/8"





Madia, finitura Grafite.  
Cupboard, Graphite finish.  
240 x 50 x 72 cm  
94 1/2" x 19 1/8" x 28 3/8"



Madia, finitura Grafite.  
Cupboard, Graphite finish.  
240 x 50 x 72 cm  
94 1/2" x 19 1/16" x 28 3/8"



Vetrina contenitore in vetro fumé.  
Showcase in smoked glass.

180 x 45 x 80 cm  
70 7/8" x 17 1/16" x 31 1/2"



# milo sideboard

DESIGN ILARIA MARELLI

Vetrina contenitore in vetro curvato da 8mm e ripiani da 10 mm, con particolari metallici in alluminio brillantato e acciaio inox; la vetrina contenitore è provvista di ante centrali in vetro diritto da 8 mm. Struttura in vetro curvato trasparente; ripiani e top trasparenti; base: vetro extralight retroargentato o laccato bianco, vetro trasparente retroverniciato nero. Struttura in vetro curvato fumè; ripiani e top fumè; base: vetro extralight retroargentato o in vetro trasparente retroverniciato nero.

Showcase in 8 mm curved glass with 10 mm shelves, with brill aluminium and stainless steel metal fittings. The showcase has central doors in 8 mm straight glass. Transparent curved glass structure: transparent shelves and top; base: extralight glass back-silvered or white back-painted or transparent glass black back-painted Smoked grey curved glass structure: smoked grey shelves and top; base: extralight glass back-silvered or transparent glass black back-painted.

Vitrine rangement en verre cintré de 8 mm et étagères de 10 mm, avec éléments métalliques en aluminium brillanté et acier inoxydable; la vitrine rangement est dotée de battants centraux en verre droit de 8 mm. Structure en verre cintré transparent : étagères et top transparents ; base : verre extralight verni dessous blanc ou argenté, verre transparent verni dessous noir. Structure en verre cintré fumé : étagères et top fumé ; base : verre extralight argenté ou en verre transparent verni dessous noir.

Showcase in 8 mm curved glass with 10 mm shelves, with brill aluminium and stainless steel metal fittings. The showcase has central doors in 8 mm straight glass. Transparent curved glass structure: transparent shelves and top; base: extralight glass back-silvered or white back-painted or transparent glass black back-painted Smoked grey curved glass structure: smoked grey shelves and top; base: extralight glass back-silvered or transparent glass black back-painted.



Vetrina contenitore.  
Showcase.

180 x 45 x 80 cm  
70 7/8" x 17 1/16" x 31 1/2"



# milo day

DESIGN ILARIA MARELLI

Vetrina in vetro curvato da 8 mm trasparente, anta in vetro da 6 mm trasparente con serratura, quattro ripiani fissi in vetro da 8 mm reggipiani in vetro saldati alla struttura. Base in vetro da 12 mm disponibile in vetro extralight acidato retroverniciato bianco o in extralight argentato. Top in vetro da 12 mm. Profili in alluminio brillantato. Predisposta per il kit di illuminazione.

Showcase in curved transparent glass 8 mm-thick, door in 6 mm-thick transparent glass with lock, glass shelves and supports. Base in 12 mm-thick glass, available extralight acid-etched white back-stained or extralight mirror-finish. Top in 12 mm-thick glass. Polished aluminum profiles. Four fix-positioned shelves in 8 mm-thick glass. Fitted for a lighting kit.

Vitrine composée d'une structure en verre cintré de 8 mm transparent et porte avec serrure en verre transparent de 6 mm. Top en verre de 12 mm. Quatre étagères fixes en verre de 8 mm et supports-étagères en verre soudés à la structure; base en verre de 12 mm disponible en verre extralight dépoli verni dessous blanc ou en verre extralight argenté. Profils en aluminium finition brill. Equipée pour un kit d'éclairage.

Vitrine aus 8 mm-starkem gebogenem transparentem Glas, Tür mit Schloß aus 6 mm-starkem transparentem Glas. Deckplatte aus 12 mm starkem Glas. Glasfachbodenträger an die Struktur verschweißt. Vier feste Fachböden aus 8 mm-starkem Glas. Sockel, 12 mm Stärke, aus extralight, geätztem weiß- hinterlackiertem Glas oder aus extralight versilbertem Glas. Profile aus poliertem Aluminium. Ausgerüstet für ein Beleuchtungsset.

Vetrina.  
Showcase.

59 x 37 x 174 cm  
23" x 14 9/16" x 68 1/2"



milo day  
DESIGN ILARIA MARELLI



Vetrina.  
Showcase.

59 x 37 x 174 cm  
23" x 14 9/16" x 68 1/2"



# milo day led

DESIGN ILARIA MARELLI

Vetrina in vetro curvato da 8 mm trasparente, anta in vetro da 6 mm trasparente con serratura, quattro ripiani fissi in vetro da 8 mm reggipiani in vetro saldati alla struttura. Base in vetro da 12 mm disponibile in vetro extralight acidato e retroverniciato bianco o in extralight argentato. Top in vetro da 12 mm. Profili in alluminio brillantato. Dei 4 ripiani in dotazione 2 sono dotati di illuminazione a led alimentati da 1 trasformatore regolatore.

Showcase in curved transparent glass 8 mm-thick, door in 6 mm-thick transparent glass with lock, glass shelves and supports. Base in 12 mm-thick extralight glass, available acid-etched white back-stained or extralight mirror-finish. Top in 12 mm-thick glass. Polished aluminum profiles. Four fix-positioned shelves in 8 mm-thick glass, two are fitted with lighting leds connected to a proper dimmer.

Vitrine composée d'une structure en verre cintré de 8 mm et porte avec serrure de 6 mm. Top en verre de 12 mm. Quatre étagères fixes en verre de 8 mm et supports-étagères en verre soudés à la structure; base en verre de 12 mm disponible en verre extralight dépoli verni dessous blanc ou en verre extralight argenté. Deux des quatre étagères sont équipés des leds d'éclairage branchés par un transformateur-varianteur.

Vitrine aus 8 mm-starkem gebogenem transparentem Glas, Tür mit Schloß aus 6 mm-starkem transparentem Glas. Deckplatte aus 12 mm starkem Glas. Glasfachbodenträger an die Struktur verschweißt. Vier feste Fachböden aus 8 mm-starkem Glas. Sockel, 12 mm Stärke, aus extralight, geätztem weiß- hinterlackiertem Glas oder aus extralight versilbertem Glas. Zwei der vier Glasfachböden sind mit Beleuchtungsled ausgerüstet. Trafo und Dimmer sind damit geliefert.

Vetrina.  
Showcase.

59 x 37 x 174 cm  
23" x 14 9/16" x 68 1/2"

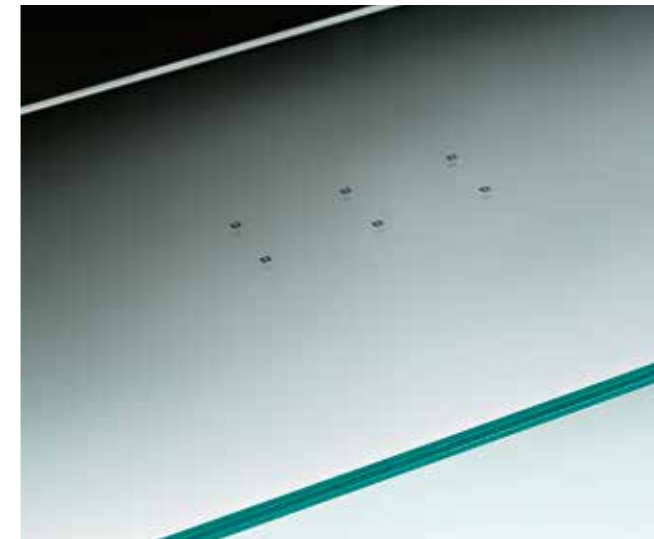
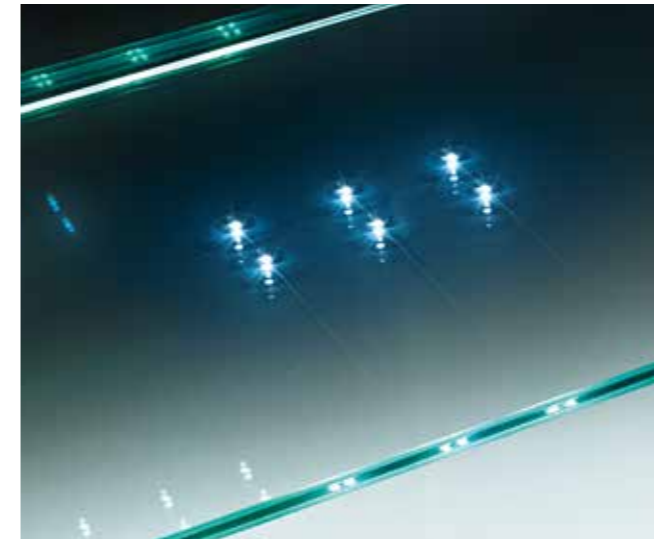



Vetrina.  
Showcase.

100 x 37 x 181 cm  
39 3/8" x 14 9/16" x 71 1/4"

# aura

DESIGN PATRICK JOUIN

Vetrina elettrificata con corpo in vetro curvato da 6 mm e tre ripiani fissi in vetro da 8 mm. Reggipiani posteriori in vetro, saldati al corpo vetrina. Top in vetro da 10 mm e base in legno laccato nero opaco. Profili e piedini in alluminio verniciato nero opaco. Anta con serratura. Illuminazione LED posizionata all'interno dei profili di alluminio.

Wired showcase in 6 mm curved glass with three 8 mm fixed glass shelves. Shelf supports in glass welded to the showcase. 10 mm glass top and base in matt black lacquered wood. Profiles and feet in matt black lacquered aluminium. Door with lock. LED lighting positioned in the aluminium profiles.

Vitrine électrifiée en verre cintré de 6 mm avec trois étagères fixes en verre de 8 mm. Supports d'étagère en verre, soudés à la structure. Top en verre de 10 mm et base en bois laqué noir mat. Profils et pieds en aluminium verni noir mat. Porte avec serrure. Éclairage LED positionné à l'intérieur des profils en aluminium.

Vitrine aus 6 mm starkem gebogenem Glas mit drei festen Fachböden aus 8 mm starkem Glas. Hintere Fachbodenhalterungen aus Glas an den Vitrinenkasten geschweißt. Deckplatte aus 10 mm starkem Glas und Sockel aus mattschwarz lackiertem Holz. Profile und Füße aus mattschwarz lackiertem Aluminium. Tür mit Schloss. LED-Beleuchtung im Innern der Aluminiumprofile.



Vetrina.  
Showcase.

100 x 37 x 181 cm  
39 3/8" x 14 9/16" x 71 1/4"





## palladio

DESIGN VITTORIO LIVI

Vetrina elettrificata in vetro curvato trasparente o extralight da 6 mm con quattro ripiani fissi in vetro da 6 mm e top in vetro da 12 mm. Base disponibile in legno noce canaletto, in vetro extralight da 12 mm acidato retroverniciato bianco o retro argentato o retroverniciato nero, Profili in alluminio finitura brill spazzolato. Anta con serratura. Corpo illuminante (optional) posizionabile anche sotto il top.

Wired showcase in 6 mm-thick curved transparent or extralight glass, with four 6 mm-thick glass shelves. 12 mm thick glass top, door with lock. Base in wood walnut "canaletto", or in 12 mm thick extralight glass: backpainted black, back-silvered or acid-etched backpainted white. Profiles in brushed aluminum glossy finish. The optional lights can also be placed under the top.

Vitrine électrifiée en verre transparent ou extralight cintré de 6 mm avec quatre étagères fixes en verre de 6 mm, top en verre de 12 mm, porte avec serrure. Base en bois noyer "canaletto". Base en verre extralight de 12 mm argenté, verni dessous noir ou dépoli verni dessous blanc Profils en aluminium brossé finition brillante. Les projecteurs peuvent être positionnés aussi sous le plateau.

Vitrine aus 6 mm-starkem gebogenem Glas, transparent oder extralight mit vier festen Fachböden aus 6 mm-starkem Glas. Ausgerüstet für eine Beleuchtung. Top aus 12 mm-starkem Glas. Basis aus Walnussholz, "Canaletto" oder Basis aus 12 mm starkem extralight Glas: Schwarz lackiert oder versilbert, geätzt Weiß lackiert Profile aus gebürstetem glänzendem Aluminium. Tür mit Schloss. Die optionale Beleuchtung kann auch unter das Top angebracht werden.

Vetrina.  
Showcase.

64 x 37 x 166 cm  
25 3/16" x 14 9/16" x 65 3/8"

Mensole Foulard.  
Foulard shelf.

palladio  
DESIGN VITTORIO LIVI

Vetrina.  
Showcase.

64 x 37 x 166 cm  
25 <sup>3</sup>/<sub>16</sub>" x 14 <sup>9</sup>/<sub>16</sub>" x 65 <sup>3</sup>/<sub>8</sub>"

Mensole Foulard.  
Foulard shelf.





# palladio

DESIGN VITTORIO LIVI

Vetrina.  
Showcase.

64 x 37 x 166 cm  
25 3/16" x 14 9/16" x 65 3/8"



# palladio uno

DESIGN VITTORIO LIVI

Vetrina elettrificata in vetro curvato trasparente o extralight da 6 mm con tre ripiani fissi in vetro da 6 mm e top in vetro da 12 mm. Base disponibile in legno noce canaletto, in vetro extralight da 12 mm acidato retroverniciato bianco o retro argentato o retroverniciato nero, Profili in alluminio finitura brill spazzolato. Anta con serratura. Corpo illuminante (optional) posizionabile anche sotto il top.

Wired showcase in 6 mm-thick curved transparent or extralight glass, with three 6 mm-thick glass shelves. 12 mm thick glass top, door with lock. Base in wood walnut "canaletto", or in 12 mm thick extralight glass: backpainted black, back-silvered or acid-etched backpainted white. Profiles in brushed aluminium glossy finish. The optional lights can also be placed under the top.

Vitrine électrifiée en verre transparent ou extralight cintré de 6 mm avec trois étagères fixes en verre de 6 mm, top en verre de 12 mm, porte avec serrure. Base en bois noyer "canaletto". Base en verre extralight de 12 mm argenté, verni dessous noir ou dépoli verni dessous blanc Profils en aluminium brossé finition brillante. Les projecteurs peuvent être positionnés aussi sous le plateau.

Vitrine aus 6 mm-starkem gebogenem Glas, transparent oder extralight mit drei festen Fachböden aus 6 mm-starkem Glas. Ausgerüstet für eine Beleuchtung. Top aus 12 mm-starkem Glas. Basis aus Walnussholz, "Canaletto" oder Basis aus 12 mm starkem extralight Glas: Schwarz lackiert oder versilbert, geätzt Weiß lackiert Profile aus gebürstetem glänzendem Aluminium. Tür mit Schloss. Die optionale Beleuchtung kann auch unter das Top angebracht werden.

Vetrina in vetro extralight.  
Showcase in extralight glass.

100 x 44 x 162 cm  
39 3/8" x 17 5/16" x 63 3/4"



# babele

DESIGN MASSIMO MOROZZI



Espositore.  
Display unit.

50 x 50 x 204 cm  
19 11/16" x 19 11/16" x 80 5/16"

# babele

DESIGN MASSIMO MOROZZI

Espositore in vetro curvato da 10 mm, con ripiani fissi bisellati da 10 mm. Disponibile anche in vetro extralight.

Display unit in 10 mm-thick curved glass with welded and bevelled 10 mm-thick glass shelves. Also available in extralight glass.

Rangement en verre cintré de 10 mm avec étagères fixes biseautées de 10 mm. Disponible aussi en verre extralight

Regal aus 10 mm-starkem gebogenem Glas. Feste 10 mm-starke Glasfachböden mit geschliffenem Rand und verklebt. Lieferbar auch aus extralight-Glas.

Espositore.  
Display unit.

50 x 50 x 204 cm  
19 11/16" x 19 11/16" x 80 5/16"



# magique totem

DESIGN STUDIO KLASS

Espositore con cubi contenitori in vetro saldato da 10 mm. Disponibile in diverse finiture: struttura in vetro extralight, contenitori in vetro bianco opale o in vetro fumè; espositore con struttura in vetro fumè, contenitori in vetro Nero95.

Display cabinet with container cubes in 10 mm welded glass. Available in various finishes: cabinet with extralight glass structure, opal white glass containers or smoked grey glass containers; smoked grey glass structure, Black95 glass containers.

Présentoir avec des cubes de rangement en verre soudé de 10 mm. Disponible en plusieurs finitions: structure en verre extralight, rangements en verre blanc opale ou en verre fumé; structure en verre fumé, rangements en verre Noir95.

Regal mit geschweißten Glasbehälter 10 mm stark, Lieferbar in diversen Finishes: Struktur aus Extralight-Glas, Behälter aus weißem Opalglas oder aus Rauchglas; Struktur aus Rauchglas, Behälter aus schwarzem Glas Schwarz95.

Espositore.  
Display unit.

38 x 38 x 172 cm  
15" x 15" x 67 1/16"



inori 186  
inori freestanding 198

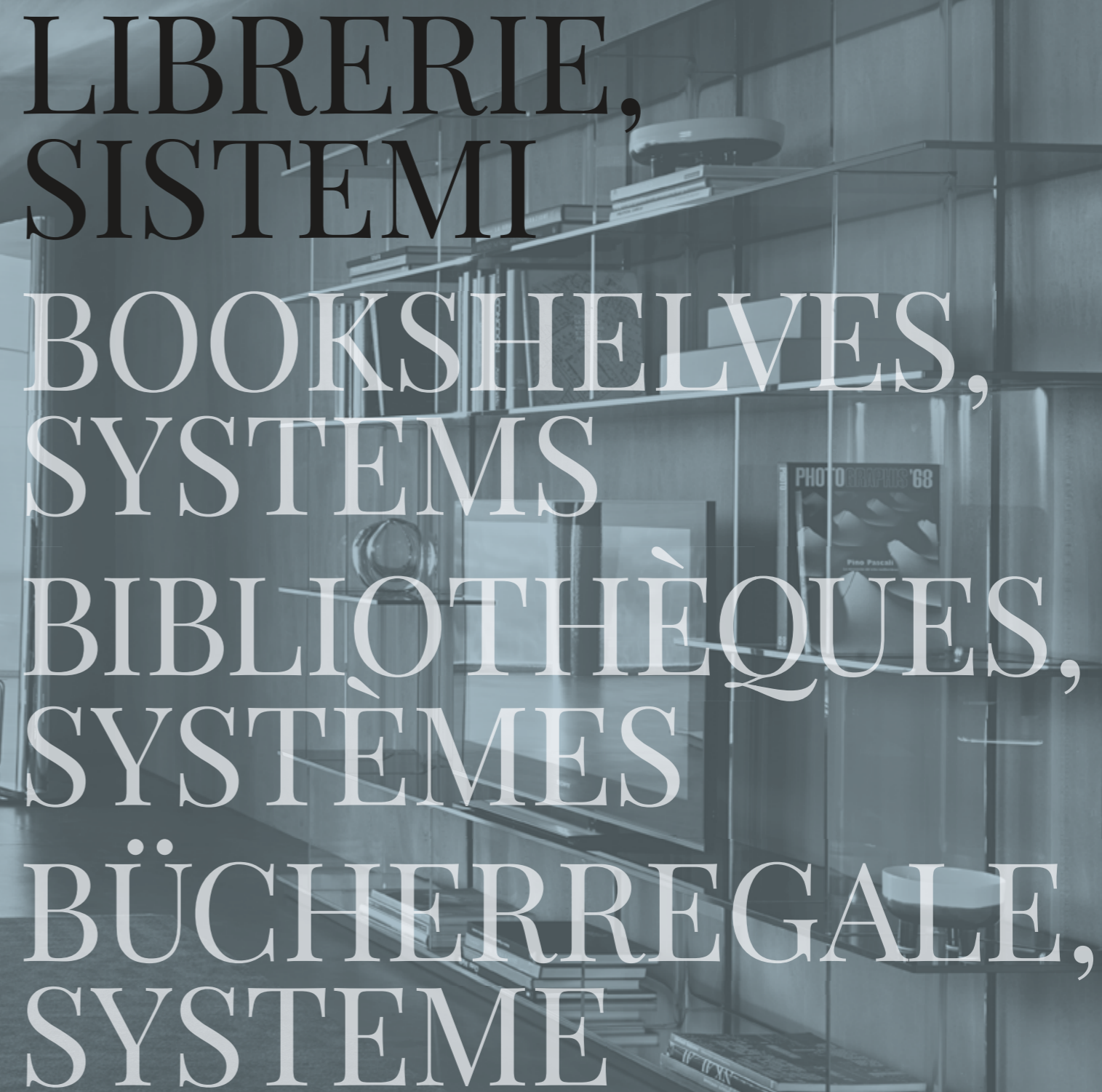

LIBRERIE,  
SISTEMI  
BOOKSHELVES,  
SYSTEMS  
BIBLIOTHÈQUES,  
SYSTÈMES  
BÜCHERREGALE,  
SYSTEME



Libreria - Porta TV  
Bookcase - TV unit

240 x 36,5 x 194 cm  
94 1/2" x 14 3/8" x 76 3/8"

Mir lampada, specchio-lampada da terra  
Mir lampada, revolving mirror-standing lamp

# inori

DESIGN SETSU E SHINOBU ITO

Sistema composto da elementi in vetro o legno modulari. La modularità e versatilità ne permette l'utilizzo come libreria, espositore, contenitore, porta Tv.

Il sistema si sviluppa anche in situazione autoportanti (inori freestanding): nelle versioni in vetro e nella misura larga cm 240, da altezza minima 135 cm sino all'altezza massima 180 cm il sistema prevede delle barre di irrigidimento in alluminio anodizzato nero.

System consisting of modular glass or wood elements. Its modularity and versatility allow it to be used as a bookcase, display case, storage unit or TV unit.

The system can also be used to construct free-standing compositions (inori freestanding): in glass versions and in width 240 cm, from a height of minimum 135 cm up to the maximum height of 180 cm the system is complete with black anodised aluminium reinforcement bars.

Système composé d'éléments modulaires en verre ou bois. Sa modularité et sa polyvalence permettent de l'utiliser comme une bibliothèque, un présentoir, un meuble de rangement, un meuble TV.

Possibilité de système autoporteur (inori freestanding): dans les versions en verre et dans la largeur de 240 cm, d'une hauteur minimale de 135 cm jusqu'à une hauteur maximale de 180 cm, le système est doté de barres d'armature en aluminium anodisé noir.

System aus modularen Glas-oder Holz-Elementen. Vielseitig einsetzbar und beliebig kombinierbar, als Bücherregal, Ausstellungsregal, TV-Element usw.

Auch freistehend als Raumteiler (inori freestanding) (aus Glas Breite 240 cm, Höhe mindestens 135 cm, maximal 180 cm, mit Verstärkungen aus Schwarz eloxiertem Aluminium).







Libreria - espositore  
Bookcase - display unit  
240 x 36,5 x 135 cm  
94 1/2" x 14 3/8" x 53 1/4"

# inori

DESIGN SETSU E SHINOBU ITO



Libreria - mobile basso.  
Bookcase - low unit.

2 sistemi da 180 x 36,5 x 50 cm  
(70 7/8" x 14 3/8" x 19 11/16") disposti ad angolo.

2 systems of 180 x 36,5 x 50 cm  
(70 7/8" x 14 3/8" x 19 11/16") placed at an angle.



Libreria - consolle.  
Bookcase - console.  
180 x 36,5 x 90 cm  
70 7/8" x 14 3/8" x 35 7/16"



Libreria - espositore.  
Bookcase - display unit.

2 sistemi da 180 x 36,5 x 190 cm  
(70 7/8" x 14 3/8" x 74 6/8").

2 systems of 180 x 36,5 x 190 cm  
(70 7/8" x 14 3/8" x 74 6/8").

## inori freestanding

DESIGN SETSU E SHINOBU ITO

Il sistema Inori Freestanding si sviluppa in situazioni autoportanti: nelle versioni in vetro e nella misura larga 240 cm, da altezza minima 135 cm sino all'altezza massima 180 cm, il sistema prevede delle barre di irrigidimento in alluminio anodizzato nero.

The system Inori offers free-standing solutions: in glass versions and in width 240 cm, from a height of minimum 135 cm up to the maximum height of 180 cm, the system is complete with black anodised aluminium reinforcement bars.

Le système Inori se présente dans des solutions autoportées: dans les versions en verre et dans la largeur de 240 cm, d'une hauteur minimale de 135 cm jusqu'à une hauteur maximale de 180 cm, le système est doté de barres d'armature en aluminium anodisé noir.

Das System Inori entwickelt sich als freistehender Raumteiler: in Glasausführung Breite 240 cm, Höhe mindestens 135 cm, maximal 180 cm, mit Verstärkungen aus Schwarz eloxiertem Aluminium.



Libreria - espositore autoportante.  
free-standing bookcase - display unit.

240 x 36,5 x 180 cm  
94 1/2" x 14 3/8" x 70 7/8"

(H max 180 cm)  
Con accessorio dedicato.  
With reinforcement bars.



babila	202
foulard	204
mensole	208
mensole rialto L	210



# MENSOLE SHELVES ÉTAGÈRES REGALE

# babila

DESIGN LUCA CASINI

Mensole in vetro curvato da 10 mm. Disponibili anche in vetro extralight. Reggimensola in metallo cromato.

Shelves in 10 mm-thick curved glass. Also available in extralight glass. Brackets in chromed metal.

Étagères en verre cintré de 10 mm. Disponible aussi en verre extralight. Support étagère en métal chromé.

Konsole aus 10 mm-starkem gebogenem Glas. Lieferbar auch aus extralight-Glas. Fachbodenträger aus verchromtem Metall.

Mensole.  
Shelves.

100 x 27 x 18,5 cm  
39 3/8" x 10 5/8" x 7 5/16"

100 x 27 x 37 cm  
39 3/8" x 10 5/8" x 14 9/16"



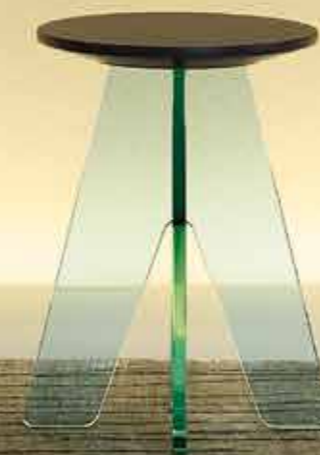

Mensole.  
Shelves.  
35 x 32 x 35 cm  
13 3/4" x 12 5/8" x 13 3/4"  
70 x 32 x 35 cm  
27 9/16" x 12 5/8" x 13 3/4"  
105 x 32 x 25 cm  
41 5/16" x 12 5/8" x 9 13/16"





# foulard

DESIGN STUDIO KLASS

Mensola in vetro  
trasparente curvato  
da 10 mm.  
Reggimensola  
in metallo cromato.

Shelf in curved  
10 mm transparent  
glass. Chromed  
metal bracket.

Etagère en verre  
transparent cintré  
de 10 mm.  
Support d'étagère  
en métal chromé.

10 mm starke Konsole  
aus gebogenem,  
transparentem Glas.  
Halterung aus  
verchromtem Metall.

Mensole.  
Shelves.

35 x 32 x 35 cm  
13 3/4" x 12 5/8" x 13 3/4"

70 x 32 x 35 cm  
27 9/16" x 12 5/8" x 13 3/4"

105 x 32 x 25 cm  
41 5/16" x 12 5/8" x 9 13/16"

# mensole

DESIGN GERUSSI - SARTORIS

Mensole in vetro curvato da 10 mm. Disponibili anche in vetro extralight  
Reggimensola in metallo verniciato nero lucido o alluminio satinato.

Shelves in 10 mm-thick curved glass. Also available in extralight glass.  
Metal bracket, glossy black or aluminium lacquered.

Étagères en verre cintré de 10 mm. Disponible aussi en verre extralight.  
Support étagère en métal verni noir brillant ou aluminium.

Konsole aus 10 mm-starkem gebogenem Glas. Lieferbar auch aus extralight-Glas.  
Fachbodenträger aus Metall hochglanz schwarz- oder Aluminium-lackiert.

Mensole.  
Shelves.

90 x 27 x 35 cm  
35 7/16" x 10 5/8" x 13 3/4"  
120 x 27 x 70 cm  
47 1/4" x 10 5/8" x 27 9/16"





Mensole.  
Shelves.  
100 x 24 x 36 cm  
39 3/8" x 9 7/16" x 14 3/16"  
140 x 24 x 40 cm  
55 1/8" x 9 7/16" x 15 3/4"

## mensole rialto L

CRS FIAM

Mensole in vetro curvato da 10 mm. Reggimensola in metallo cromato. Le mensole sono disponibili anche su misura con i seguenti limiti: lunghezza: da 65 cm a 190 cm; profondità: da 24 cm a 30 cm; altezza: fino a 36 cm per lunghezze entro i 100 cm e fino a 70 cm per lunghezze oltre i 100 cm. L'interasse massimo tra i reggimensola è di 70 cm.

Shelves in 10 mm curved glass. Chromed metal brackets. The shelves are also available custom-sized with the following limits: length: from 65 cm to 190 cm; depth: from 24 cm to 30 cm; height: up to 36 cm for lengths up to 100 cm and up to 70 cm for lengths over 100 cm. The maximum gap between brackets is 70 cm.

Etagères en verre cintré de 10 mm Supports d'étagère en métal chromé. Les étagères sont également disponibles sur mesure avec les limites suivantes : longueur: de 65 cm à 190 cm, profondeur : de 24 cm à 30 cm, hauteur : jusqu'à 36 cm pour les longueurs inférieures à 100 cm et jusqu'à 70 cm pour les longueurs supérieures à 100 cm. La distance maximale entre les supports d'étagère est de 70 cm.

Konsole aus 10 mm starkem, gebogenem Glas. Konsolehalterungen aus verchromtem Metall. Auch maßgefertigt lieferbar in Längen von 65 bis 190 cm, Tiefen von 24 bis 30 cm, Höhen bis 36 cm für Längen bis 100 cm, Höhen bis 70 cm für Längen über 100 cm. Maximaler Mittenabstand zwischen den Halterungen 70 cm.

Mensole.  
Shelves.

100 x 24 x 36 cm  
39 3/8" x 9 7/16" x 14 3/16"

140 x 24 x 40 cm  
55 1/8" x 9 7/16" x 15 3/4"



cobra	224
elix	228
homo sapiens	226
l'astra	222
loy-k	216
mir lampada	220
vogue	230



ACCESSORI  
ACCESSORIES  
ACCESSOIRES  
ACCESSOIRES

# loy-k

DESIGN CHAFIK GASMI

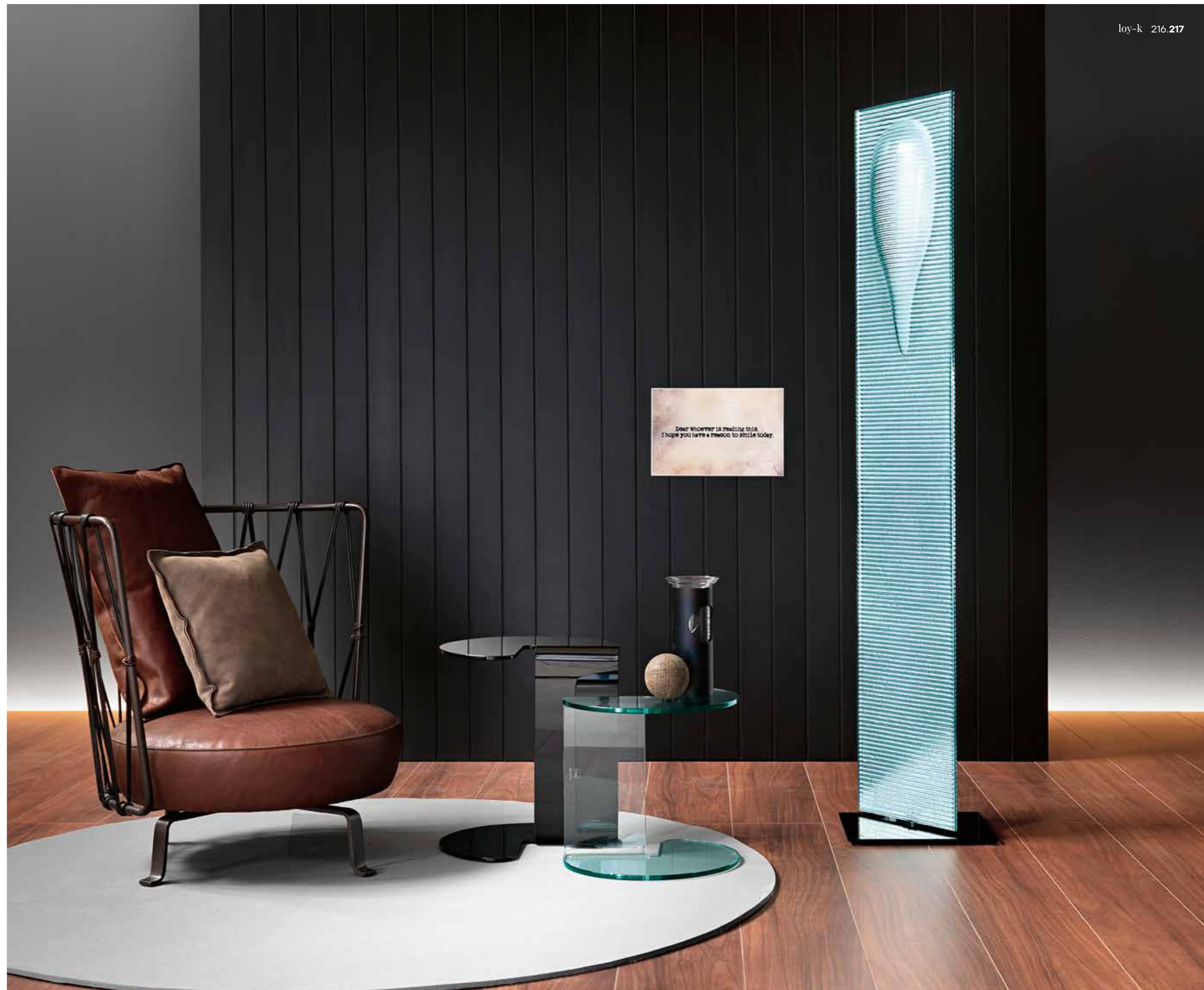

Lampada da terra girevole.  
Revolving free-standing lamp.

38 x 37 x 190 cm  
15" x 14 9/16" x 74 13/16"

Serie a tiratura limitata:  
40 pezzi unici numerati per celebrare  
il 40° Anniversario Fiam.

Limited edition:  
40 numbered pieces celebrating  
Fiam 40th Anniversary.

# loy-k

DESIGN CHAFIK GASMI

Specchio-lampada da terra girevole con scocca in vetro curvato a gran fuoco argentato da 6 mm. Telaio interno in acciaio verniciato, base a specchio da 8 mm saldata su piatto in acciaio verniciato. Provvisto di kit illuminazione interna. Serie a tiratura limitata: 40 pezzi unici numerati per celebrare il 40° Anniversario Fiam.

Revolving mirror-standing lamp with 6 mm high temperature curved silvered glass frame. Inside supporting mount in painted steel, base composed of a 8 mm thick mirror jointed to a lacquered steel plate. Lighting kit inside. Limited edition: 40 numbered pieces celebrating Fiam 40th Anniversary.

Miroir-lampadaire pivotant avec coque en verre cintré en fusion argenté de 6 mm. Cadre interne en acier verni, base en miroir de 8 mm soudée sur plat en acier. Kit éclairage interne. Edition limitée : 40 pièces numérotées pour célébrer le 40e anniversaire Fiam.

Drehbares Spiegel-Stehlampenelement mit bei sehr hohen Temperaturen versilberter, 6 mm starker gebogener Glas. Spiegel Basis, 8 mm stark, verschweißt auf einem Stahlplatte. Integrierter Beleuchtung. Limitierte Auflage: 40 nummerierte Exemplare, zum 40. Jahrestag Fiam.



Specchio-lampada da terra girevole.  
Revolving mirror-standing lamp.

38 x 37 x 190  
15" x 14 9/16" x 74 13/16"

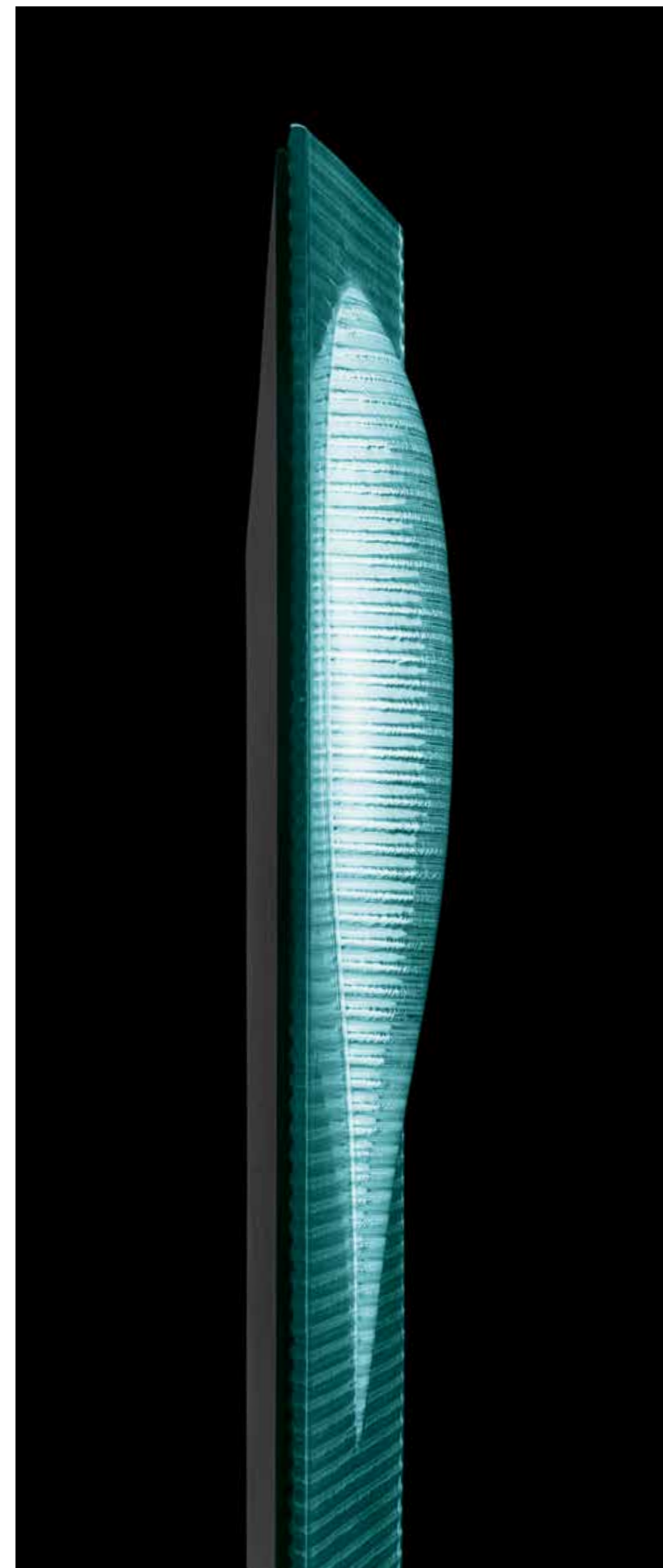



## mir lampada

DESIGN ROBERTO PAOLI

Specchio-lampada da terra girevole con scocca in vetro curvato a gran fuoco argentato da 6 mm. Telaio interno in acciaio verniciato, base a specchio da 8 mm saldata su piatto in acciaio verniciato. Provvisto di kit illuminazione interna.

Revolving mirror-standing lamp with 6 mm high temperature curved silvered glass frame. Inside supporting mount in painted steel, base composed of a 8 mm thick mirror jointed to a lacquered steel plate. Lighting kit inside.

Miroir-lampadaire pivotant avec coque en verre cintré en fusion argenté de 6 mm. Cadre interne en acier verni, base en miroir de 8 mm soudée sur plat en acier. Kit éclairage interne.

Drehbares Spiegel-Stehlampenelement mit bei sehr hohen Temperaturen versilberter, 6 mm starker gebogener Glas. Spiegel Basis, 8 mm stark, verschweißt auf einem Stahlplatte. Integrierter Beleuchtung.

Specchio-lampada da terra girevole.  
Revolving mirror-standing lamp.

Ø 53 x 198 cm  
Ø 20 7/8" x 77 15/16"





# l'astra

DESIGN LO BIANCO-MANSUETO

Lampada da tavolo  
in vetro curvato da 8 mm.  
Portalampada  
in alluminio brill.

Table lamp in 8 mm  
curved glass.  
Polished aluminium  
lamp holder.

Lampe de table  
en verre cintré  
de 8 mm. Douille  
en aluminium brillant.

Tischleuchte aus 8 mm  
starkem gebogenem Glas.  
Lampenfassung aus  
geglänzttem Aluminium.



Lampada da tavolo.  
Table lamp.

26 x 29 x 46 cm  
10 1/4" x 11 7/16" x 18 1/8"

Console LLT.  
LLT console.



# cobra

DESIGN ELIO VIGNA

Portaombrelli in vetro  
curvato da 10 mm  
con basamento  
in metallo verniciato nero.

Umbrella stand  
in 10 mm-thick  
curved glass  
with black metal base.

Porte-parapluies  
en verre cintré de 10 mm  
avec base  
en métal verni noir.

Schirmständer aus  
10 mm-starkem  
gebogenem Glas  
mit schwarz-lackierter  
Metallbasis.

Portaombrelli.  
Umbrella stand.

35 x 35 x 67 cm  
13 3/4" x 13 3/4" x 26 3/8"



# homo sapiens

DESIGN FABIO DI BARTOLOMEI

Servo muto in vetro curvato da 12 mm, con base a calotta sferica rivestito in ABS nero goffrato. Bicchieri porta-oggetti verniciato nero opaco.

Valet in 12 mm-thick curved glass casted to a spherical cap base, in black coated ABS. Object-holder matt black lacquered.

Valet en verre cintré de 12 mm ancré à un piétement à calotte sphérique revêtu en ABS couleur noire gaufrée. Porte-objets verni noir mat.

Kleiderständer aus 12 mm-starkem gebogenem Glas. Kugelkappenförmiger Basis mit ABS-Kunststoff beschichtet, schwarz geprägt. Ablageschälchen aus schwarz-lackiertem Holz.

Servo muto.  
Valet.

47 x 37 x 129 cm  
18 1/2" x 14 9/16" x 50 3/4"



# elix

DESIGN FABIO DI BARTOLOMEI

Appendiabito in vetro curvato da 15 mm con base a calotta sferica, rivestito in ABS nero goffrato, accessori color nero.

Coat-hanger in 15 mm-thick curved glass, casted to a spherical cap base, in black coated ABS, black lacquered accessories.

Porte-manteaux en verre cintré de 15 mm ancré à un piétement à calotte sphérique revêtu en ABS couleur noire mate. Accessoires noirs.

Gardenrobeständer aus 15 mm-starkem gebogenem Glas. Kugelkappenförmiger. Basis mit ABS-Kunststoff beschichtet, schwarz geprägt.

Appendiabiti.  
Coat-hanger.

Ø 37 x 187 cm  
Ø 14 9/16" x 73 5/8"





## vogue

DESIGN ROBERTO PAOLI

Portariviste in vetro  
trasparente curvato  
da 10 mm con appoggi  
in acciaio inox.

Magazine rack in 10 mm  
curved transparent glass  
with steel stand.

Porte-revues en verre  
transparent cintré  
de 10 mm avec supports  
en acier inoxydable.

Zeitungsständer aus 10 mm  
starkem, gebogenem,  
transparentem Glas  
mit Edelstahl Untergestell.



Portariviste.  
Magazine rack.

40 x 12 x 30 cm  
15 3/4" x 4 3/4" x 11 3/4"

## Design su misura



I prodotti Custom-made Fiam, progettati da designer di fama mondiale, nascono per consentire ad una committenza esigente ed evoluta, di adattare complementi di grande prestigio alle proprie necessità. Fiam ha sperimentato l'efficacia di concepire il prodotto di design come oggetto dinamico e versatile, permettendo, a chi lo sceglie, di diventare co-autore di un'opera unica. In particolar modo, Rialto, Rialto L e Luxor, offrono varie possibilità di trasformazione di misura e assetto. Ogni pezzo è personalizzabile anche utilizzando complementi a cassetteria scegliendo dimensioni, forme e finiture diverse. Dalla modularità del sistema Caadre, invece, si possono ottenere infinite soluzioni per arredare pareti, divisori e pannellature.

## Design sur mesure



Les produits Fiam sur mesure, conçus par des designers de renommée mondiale, ont été conçus pour un client exigeant et évolué lui permettant d'adapter des produits de grand prestige à ses propres besoins. Fiam a connu l'efficacité de la conception du produit comme un objet dynamique et polyvalent, ce qui permet, à ceux qui le choisissent, de devenir co-auteur d'une pièce unique. En particulier, Rialto, Rialto L et Luxor, offrent divers possibilités d'un traitement de mesure et de configuration. Chaque pièce est également personnalisable à l'aide de caissons à tiroirs où on peut choisir les tailles, formes et finitions différentes. La modularité du miroir Caadre cependant permet d'obtenir une infinité de solutions comme cloison, boiserie et pour décorer les murs.

## Custom-made design



Fiam Custom-made products, styled by world-famous designers, are intended to allow a discerning clientele at the leading edge of the market to adapt prestige items of furniture to their own specific needs. Fiam has proven the effectiveness of conceiving a designer product as a dynamic, versatile piece, giving clients the opportunity of becoming joint creators of a unique work of art. Rialto, Rialto L and Luxor, in particular, offer a variety of possibilities for transformation of their size and layout. Each piece can be customised, for example by completing it with a drawer unit with specially chosen size, shape and finish. The modular Caadre provide the basis for an infinite variety of compositions, for furnishing walls, partitions and panelling structures.

## Design nach Wunsch



Die Custom-made gefertigten Produkte von Fiam, von weltberühmten Designern entworfen, wurden entwickelt, um anspruchsvollen und bedeutenden Kunden die Möglichkeit zu bieten, wertvolle Stücke mit Prestige, ihren eigenen Bedürfnisse anzupassen. Fiam hat den Vorteil der Konzeption eines Design-Produkts als ein dynamisches und vielseitiges Objekt genutzt, das denjenigen, die es auswählen, zum Co-Autor eines einzigen Werks werden. Insbesondere die Modelle Rialto, Rialto L und Luxor, bieten verschiedene Möglichkeiten von Sondermasse und Ausführungen. Jedes Stück kann auch mit Schubladen ausgestattet werden, und bietet eine Auswahl von Sondergrößen, Formen und Ausführungen. Dank der Modularität des Caadre kann man unendlich viele Lösungen anbieten um Wände zu dekorieren, als Raumteiler oder als Vertäfelung.

I CUSTOMIZZABILI  
THE CUSTOMIZABLES  
LES PERSONNABISABLES  
DIE ANPASSBAREN

# I Customizzabili

The Customizables  
Les personnalisables  
Die Anpassbaren

## SPECCHI

MIRRORS  
MIROIRS  
SPIEGEL



	CAADRE	CAADRE TV	CALDEIRA	CHRISTINE	DORIAN	HASAMI	HIROSHI	LUCY	MARY
Misure H. - L. Dimensions H. - L.	•	•							
Finiture vetro Glass finish	•	•	•	•	•	•	•	•	•
Laccatura Lacquering	•	•	•	•	•			•	•



	MIRAGE	MIRAGE TV	PHANTOM	REVERSO	RITRATTO	ROSY	THE WING	VENUS
Misure H. - L. Dimensions H. - L.	•	•						
Finiture vetro Glass finish	•		•	•	•	•	•	•
Laccatura Lacquering			•		•	•	•	•

# caadre

DESIGN  
PHILIPPE STARCK

Caadre di Philippe Stark oggi diventa anche un elegante e insolito sistema modulare. Esempio di semplicità e di stile, è in grado di assumere l'identità di specchiera, diventando particolare distintivo di una parete o di moltiplicarsi e combinarsi a piacere, per costituire la parete stessa.

Caadre by Philippe Stark can now also become an elegant, unusual modular system. The utmost in stylish simplicity, it is able to assume the identity of a mirror to form the keynote of a wall, or multiply and combine exactly as required to create the wall itself.

Caadre de Philippe Stark devient maintenant aussi un système modulaire élégant et inhabituel. Exemple de simplicité et de style, il est en mesure d'assumer l'identité de miroir, devenant particulièrement distinctif d'un mur ou de se multiplier et combiner à volonté, pour constituer le mur lui-même.

Caadre von Philippe Stark wird nun auch ein elegantes und ungewöhnliches Modulsystem. Beispiel von Simplizität und Stil ist er in der Lage, die Identität des Spiegels zu nehmen, als kennzeichnendes Element einer Wand oder erweitert er sich und nach Wunsch kombiniert, die Wand selbst wird.

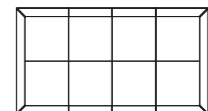

## Dimensioni standard Standard dimensions Dimensions standards Standard Abmessungen

105 x 13 x 195 cm  
41 5/16" x 5 1/8" x 76 3/4"  
76 x 13 x 195 cm  
29 15/16" x 5 1/8" x 76 3/4"  
195 x 13 x 195 cm  
76 3/4" x 5 1/8" x 76 3/4"  
140 x 13 x 195 cm  
55 1/8" x 5 1/8" x 76 3/4"  
105 x 13 x 155 cm  
41 5/16" x 5 1/8" x 61"  
76 x 13 x 155 cm  
29 15/16" x 5 1/8" x 61"  
140 x 13 x 140 cm  
55 1/8" x 5 1/8" x 55 1/8"  
105 x 13 x 105 cm  
41 5/16" x 5 1/8" x 41 5/16"  
155 x 13 x 240 cm  
61" x 5 1/8" x 94 1/2"

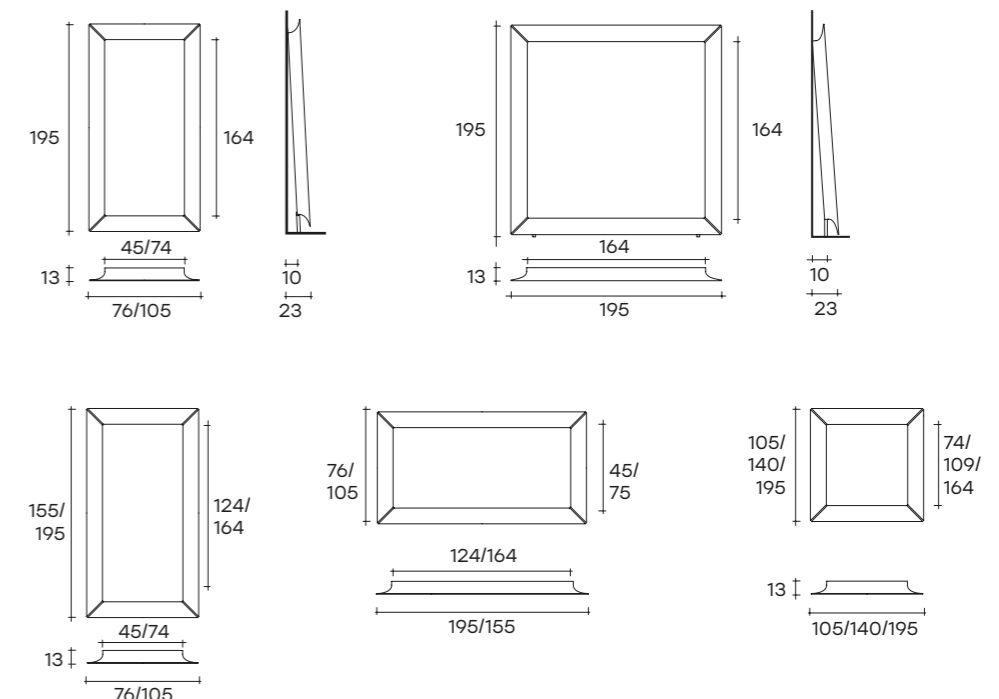



Esempi fra le innumerevoli soluzioni custom \_ Examples among the many custom solutions  
 Exemples parmi les nombreuses solutions sur demande \_ Beispiele unter den vielen Lösungen



Negozió \_ Shop  
 Magasin \_ Geschäft L. P. H. \_ L. W. H.  
 467 x 13 x 358 cm

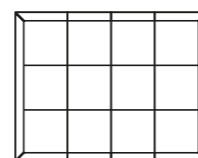

Moduli disponibili \_ Available modules  
 Modules disponibles \_ Verfügbaren Elemente

L. P. H. \_ L. W. H.

**Mod. A**  
 min. 124,5 x 13 x 124,5 cm  
 max. 169,5 x 13 x 169,5 cm

Larghezza fissa aletta  
 Frame width  
 15,5 cm

**Mod. B**  
 min. 124,5 x 13 x 109 cm  
 max. 169,5 x 13 x 164 cm

**Mod. C**  
 min. 109 x 13 x 109 cm  
 max. 164 x 13 x 164 cm

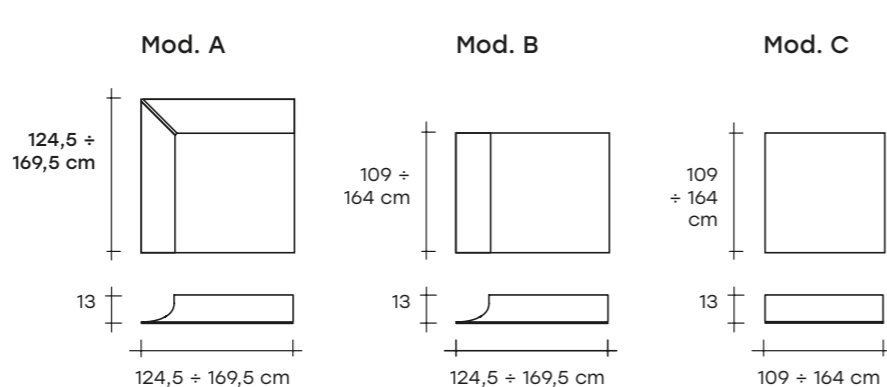
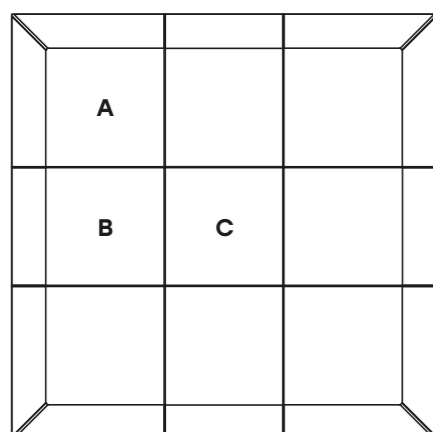

Appartamento \_ Apartment  
 Appartement \_ Wohnung L. P. H. \_ L. W. H.  
 253 x 13 x 195 cm

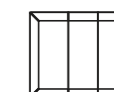

Moduli disponibili \_ Available modules  
 Modules disponibles \_ Verfügbaren Elemente

L. P. H. \_ L. W. H.

**Mod. D**  
 min. 124,5 x 13 x 140 cm  
 max. 169,5 x 13 x 195 cm

Larghezza fissa aletta  
 Frame width  
 15,5 cm

**Mod. E**  
 min. 109 x 13 x 140 cm  
 max. 164 x 13 x 195 cm  
 min. 140 x 13 x 109 cm  
 max. 195 x 13 x 164 cm

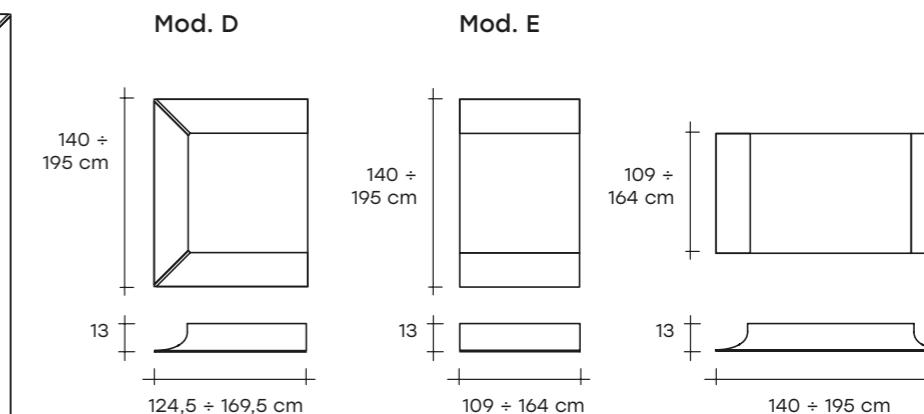
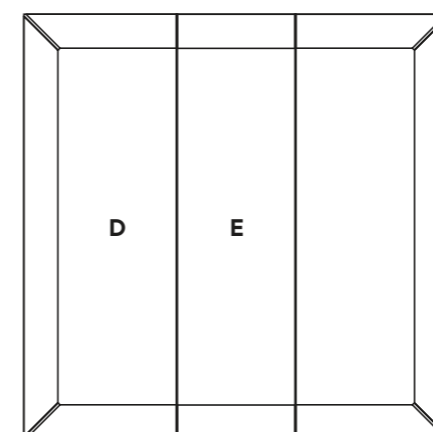

# mirage

DESIGN  
DANIEL LIBESKIND

Specchio da parete con cornice in alluminio finitura brill. Lo specchio offre sia un'ampia gamma di misure che un'ampia possibilità di customizzazione.

Wall mirror with brill finish aluminium frame. The mirror is available in a wide range of sizes and offers several customization solutions.

Miroir à accrocher avec cadre en aluminium finition brill. Le miroir offre un vaste assortiment de mesures et une large gamme de personnalisation.

Wandspiegel mit Rahmen aus Aluminium Finish Brill. In vielen verschiedenen Größen und Personalisierungen.

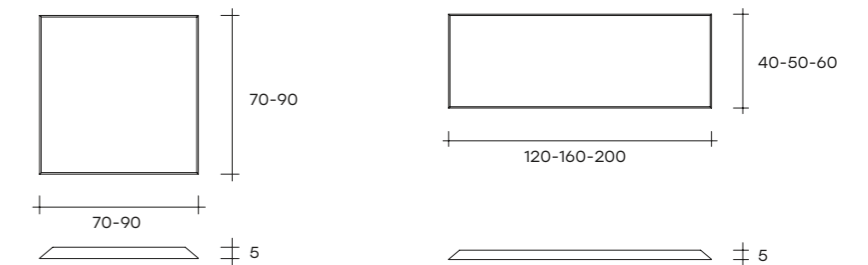

**Dimensioni standard**  
Standard dimensions  
Dimensions standards  
Standard Abmessungen

70 x 5 x 70 cm  
27 9/16" x 2" x 27 9/16"  
90 x 5 x 90 cm  
35 7/16" x 2" x 35 7/16"  
120 x 5 x 40 cm  
47 1/4" x 2" x 15 3/4"  
160 x 5 x 50 cm  
62" x 2" x 19 1/16"  
200 x 5 x 60 cm  
78 3/4" x 2" x 23 5/8"

**Dimensioni custom**  
Custom dimensions  
Dimensions sur demande  
Massgefertigte Abmessungen

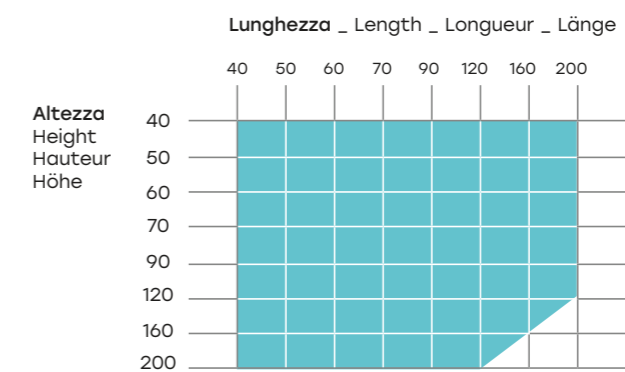

# I Customizzabili

The Customizables  
Les personnalisables  
Die Anpassbaren

## VETRINE, ESPOSITORI, MENSOLE

SHOWCASE,  
DISPLAY UNIT, SHELVES  
VITRINE, PRESENTOIRS,  
ÉTAGÈRES  
VITRINE, REGALE,  
KASTEN



	AURA	BABELE	BABILA	FOULARD	MENSOLE	MENSOLE RIALTO	MILO	MILO SIDEBOARD	PALLADIO
Misure H. - P. - L. Dimensions H. - P. - L.		•						•	
Finiture vetro Glass finish	•	•	•	•	•	•	•	•	•
Laccatura Lacquering	•	•	•	•	•	•	•	•	•



	PALLADIO UNO	PLIE'
Misure H. - P. - L. Dimensions H. - P. - L.		
Finiture vetro Glass finish	•	•
Laccatura Lacquering	•	•

## SISTEMI, CONTENITORI COMPONIBILI

SYSTEMS,  
CONTAINER CABINETS  
SYSTÈMES, MEUBLES  
DE RANGEMENT  
SYSTEME, KASTEN

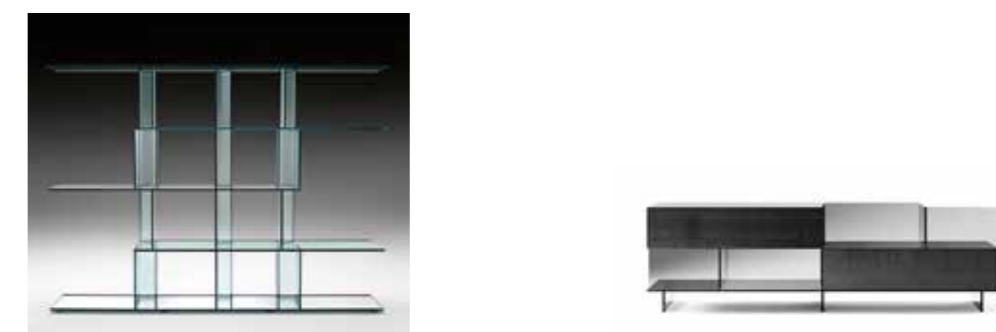

	INORI	VARESINA
Misure H. - P. - L. Dimensions H. - L.	•	•
Finiture vetro Glass finish	•	•
Laccatura Lacquering	•	



# inori

DESIGN SETSU  
E SHINOBU ITO

La libreria modulare Inori, disegnata per Fiam da Setsu & Shinobu Ito, è il primo sistema nel settore dell'arredo interamente in vetro composto da elementi modulari. Inori può essere utilizzata come libreria, espositore, contenitore e porta-TV: tutte le soluzioni sono sviluppabili in versioni a parete o autoportanti. La modularità e la versatilità del sistema permettono infatti di creare infinite forme compositive; inoltre base e ripiani possono essere personalizzabili nella lunghezza e nei colori, raggiungendo così un elevato grado di customizzazione.

The Inori modular bookcase, designed for Fiam by Setsu & Shinobu Ito, is the first system in the furniture industry entirely made of glass, and composed of modular elements. Inori can be used as a bookcase, a display, a container, and a TV stand: all solutions are developable in wall or freestanding versions. The modularity and versatility allows you to create endless compositional shapes. Base and shelves can also be customized for length and colours, thus achieving a high degree of customisation.

La bibliothèque modulaire Inori, conçue pour Fiam par Setsu & Shinobu Ito, est le premier système dans le secteur qui soit entièrement de verre et composé d'éléments modulaires. Inori peut être utilisée comme une bibliothèque, un présentoir, un contenant et un meuble TV: toutes les solutions sont développables en versions murales ou autonomes. La modularité et la polyvalence permettent de créer des compositions dans une infinité de formes. Les bases et les étagères peuvent également être personnalisées en longueur et en couleurs, atteignant ainsi un haut degré de personnalisation.

Das von Setsu & Shinobu Ito für Fiam designte Modulbücherregal Inori ist im Einrichtungsbereich das erste vollständig aus Glas bestehende Regalsystem, das aus Modulen besteht. Inori kann als Bücherregal, Vitrine, Behälter und TV-Möbel verwendet werden. Alle Lösungen sind in den Ausführungen Wandbefestigung oder stehend erhältlich. Modulsystem und Vielseitigkeit ermöglichen eine unendliche Kombinationen. Die Basis und die Fachböden sind in Länge und Farbe variabel, was außerdem viel Raum für eine individuelle Gestaltung bietet.



## Dimensioni standard Standard dimensions Dimensions standards Standard Abmessungen

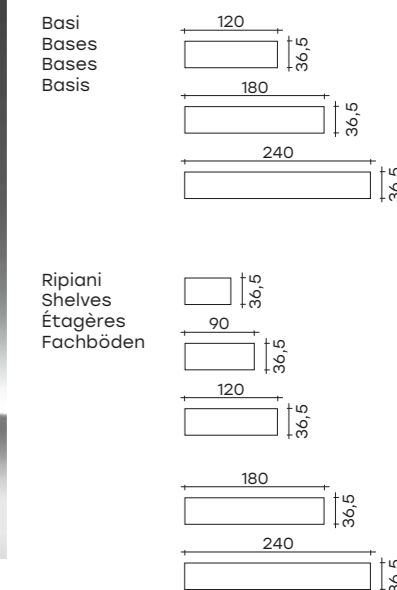

### Ripiani in vetro temperato, spessore 12 mm o legno spessore 40 mm.

Shelves in tempered glass,  
12 mm-thick or wood 40 mm-thick.  
Étagères en verre trempé  
de 12 mm. Étagères en bois,  
épaisseur 40 mm.

Fachböden aus gehärtetem  
12 mm starkem Glas.  
Holzfachböden, 40 mm Stärke.

### Base d'appoggio in vetro temperato, spessore 12 mm o legno spessore 40 mm.

Base in tempered glass,  
12 mm-thick  
or wood 40 mm-thick.  
Base en verre trempé de 12 mm.  
Base en bois, épaisseur 40 mm.

Basis aus gehärtetem 12 mm  
starkem Glas.  
Holzbasis, 40 mm Stärke.

### Montanti in vetro curvato da 10 mm.

Uprights in curved glass,  
10 mm-thick.  
Montants en verre  
cintré de 10 mm.  
Stütze aus gebogenem  
Glas, 10 mm.

### Altezza massima per le strutture autoportanti

Su basi di lunghezza 120 cm: h max 50 cm  
Su basi di lunghezza 180 cm: h max 135 cm  
Su basi di lunghezza 240 cm solo vetro: h 180 cm,  
con accessorio dedicato

**Altezza massima per le strutture con ancoraggio a muro:**  
massimo 5 ripiani totali, base esclusa

### Max. height of the free-standing version

With base length 120 cm: h max 50 cm  
With base length 180 cm: h max 135 cm  
With base length 240 cm glass version:  
h 180 cm, with accessories

**Max. height of the wall version:**  
max 5 shelves, base excluded

### Hauteur maxi. pour les structures posées au sol

Avec base de longueur 120 cm: h max 50 cm  
Avec base de longueur 180/240 cm: h max 135 cm  
Avec base de longueur 240 cm:

a partir de h 135 cm à 180 cm, avec accessoires  
**Hauteur maxi. pour les structures accrochables au mur:**  
avec max 5 étagères base excluse.

### Max. Höhe der Standausführung

mit Basislänge 180 / 240 cm: H max 90 cm  
mit Basislänge 120 cm: H max 50 cm  
mit Basislänge 240 cm: von H 135 bis H 180 cm,  
mit Accessoires

**Max. Höhe der Wandausführung:**  
mit max 5 Fachböden die Basis ausgeschlossen.

Montanti / Uprights  
Montants / Stütze

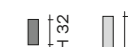

portata sui ripiani: 80 kg  
portata massima  
struttura: 400 kg  
distanza massima  
tra i montanti: 130 cm

load capacity on shelves: 80 kg  
structure load capacity: 400 kg  
max. distance between  
the uprights: 130 cm

portée sur les étagères: 80 kg  
portée max structure: 400 kg  
distance maxi entre  
les montants: 130 cm

Tragfähigkeit  
der Fachboden: 80 kg  
Tragfähigkeit der Struktur: 400 kg  
Max. Abstand zwischen  
den Stützen: 130 cm



# mensole rialto L

DESIGN  
CRS FIAM

Versione a forma di lettera "L" in appoggio su cassettera. In questo oggetto di design, personalizzabile, la sintesi di Rialto compie un ulteriore passo avanti. Il Centro Ricerca e Stile Fiam sviluppa un capolavoro di progettazione, minimale ed elegante, stabile e sorretto dalla migliore ricerca tecnologica nel settore del cristallo curvato.

L-shaped version standing on a drawer unit. In this customisable design piece, Rialto's synthesis becomes even more absolute. The Fiam Research and Style Centre has achieved a design masterpiece, minimal and elegant, stable and supported by the best technological research in the curved plate glass sector.

Version en forme de « L » avec appui sur le meuble à tiroirs. Dans cet objet de design personnalisable, les capacités de synthèse de Rialto passent à un niveau supérieur. Le Centre de Recherche et de Style Fiam a développé un chef-d'œuvre de conception minimale et élégante, stable et reposant sur la meilleure recherche technologique dans le secteur du verre cintré.

L-förmige Version, die auf dem Schubladenkasten aufliegt. Mit diesem personalisierbaren Design-Gegenstand gelingt dem Zusammenspiel von Rialto ein weiterer Schritt nach vorne. Die Abteilung für Forschung und Stil von Fiam schafft ein Meisterwerk der Projektierung, minimal und elegant, stabil und getragen von der besten technologischen Forschung im Bereich des gebogenen Glases.

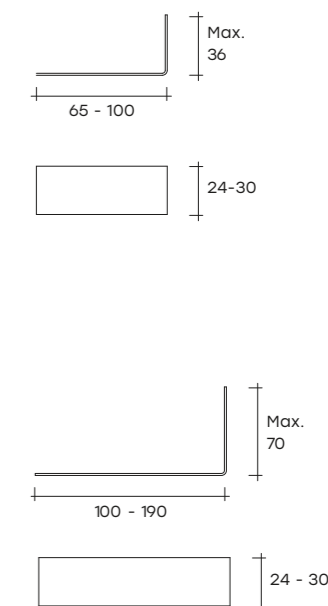

**Dimensioni standard**  
Standard dimensions  
Dimensions standards  
Standard Abmessungen

**L. P. H. \_ L. W. H.**

190 x 30 x 40 cm  
74 13/16" x 11 13/16" x 15 3/4"

140 x 24 x 40 cm  
55 1/8" x 9 7/16" x 15 3/4"

100 x 24 x 36 cm  
39 3/8" x 9 7/16" x 14 3/16"

65 x 24 x 30 cm  
25 9/16" x 9 7/16" x 11 13/16"

**Dimensioni custom**  
Custom dimensions  
Dimensions sur demande  
Massgefertigte Abmessungen

**Lunghezza \_ Length \_ Longueur \_ Länge**

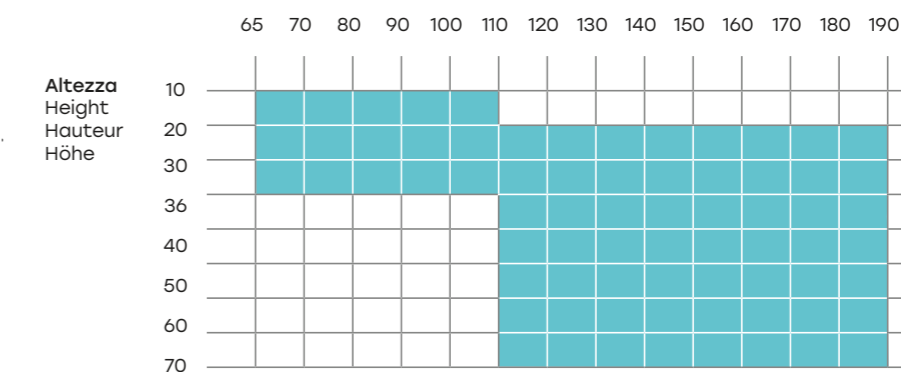

Profondità: può essere scelta liberamente tra un minimo di 24 cm ed un massimo di 30 cm.

Width: can be chosen freely from a minimum of 24 cm and a maximum of 30 cm.

La profondeur se peut réaliser entre mini. 24 cm - maxi. 30 cm.

Tiefe wahlweise zwischen min. 24 cm maxi. 30 cm.



SPECCHI, SPECCHI TV	admiral	252
	caadre	253
MIRRORS, MIRRORS-TV	caadre tv	280
	caldeira	254
	christine	256
	dorian	258
	hasami	259
	hiroshi	260
	let me see	261
	lucy	262
	mary	263
	mir	264
	mir lampada	265
	mirage	266
	mirage tv	281
	phantom	268
	reverso	271
	ritratto	272
	rosy	275
	the wing	276
venus	279	

LIBRERIE, SISTEMI	inori	292
	inori freestanding	293
BOOKSHELVES, SYSTEMS		

MENSOLE SHELVES	babila	298
	foulard	299
	mensole	300
	rialto L	301

ACCESSORI ACCESSORIES	cobra	302
	elix	303
	homo sapiens	304
	l'astra	305
	loy-k	306
	mir lampada	307
vogue	309	

ESPOSITORI, VETRINE, CONTENITORI	aura	282
	babele	283
	magique totem	284
	milo day	285
	milo day led	286
	milo sideboard	287
	palladio	288
	palladio uno	289
	plié	290
	varesina	291
SHOWCASES, DISPLAY UNITS, CONTAINER CABINETS		

# SCHEDE TECNICHE TECHNICAL DATA SHEETS FICHES TECHNIQUE DATENBLÄTTER

# ghost

DESIGN  
CINI BOERI



Poltrona in vetro  
curvato da 12 mm.

Monolithic chair  
in 12 mm-thick  
curved glass.

Fauteuil en verre cintré  
d'une seule dalle  
de verre de 12 mm.

Sessel aus gebogenem  
12 mm-starkem Glas,  
aus einer einzigen  
Glasplatte gefertigt.

95 x 75 x 68  
37 3/8 x 29 1/2" x 26 3/4"

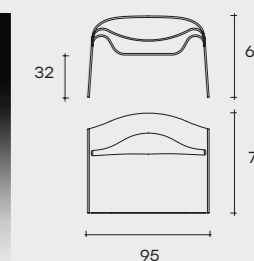
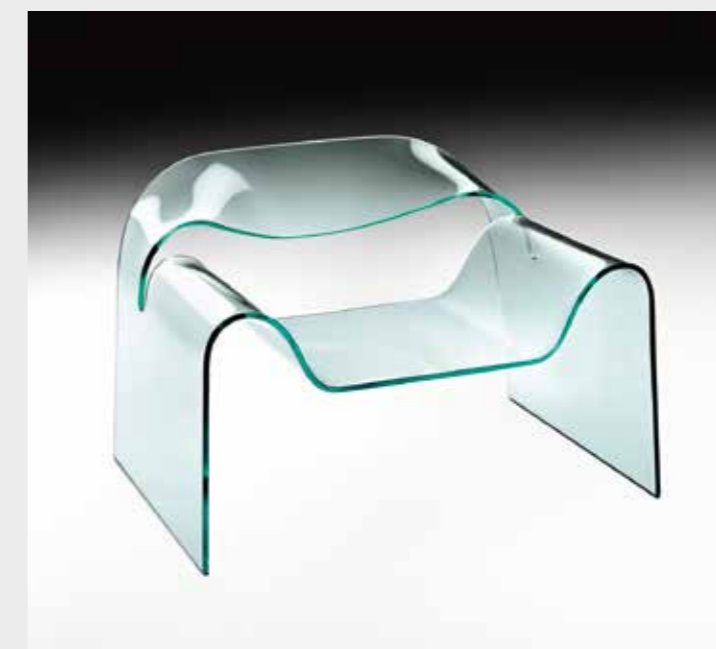



# admiral

DESIGN  
FABIO DI BARTOLOMEI

Specchio bifacciale  
in vetro curvato  
da 12 mm con base  
a calotta sferica  
rivestito in ABS  
nero goffrato.

Double-sided mirror  
with 12 mm-thick  
glass casted  
to a spherical cap base,  
black ABS coated.

Miroir biface en verre  
cintré de 12 mm ancré  
à un piétement  
à calotte sphérique  
en ABS couleur  
noire gaufrée.

Doppelseitiger Spiegel  
aus 12 mm-starkem  
gebogenem Glas  
mit kugelkappenförmiger  
Basis, mit ABS-Kunststoff  
beschichtet  
und schwarz geprägt.

40 x 37 x 187 cm  
15 3/4" x 14 9/16" x 73 5/8"

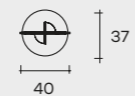
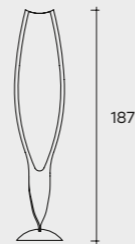
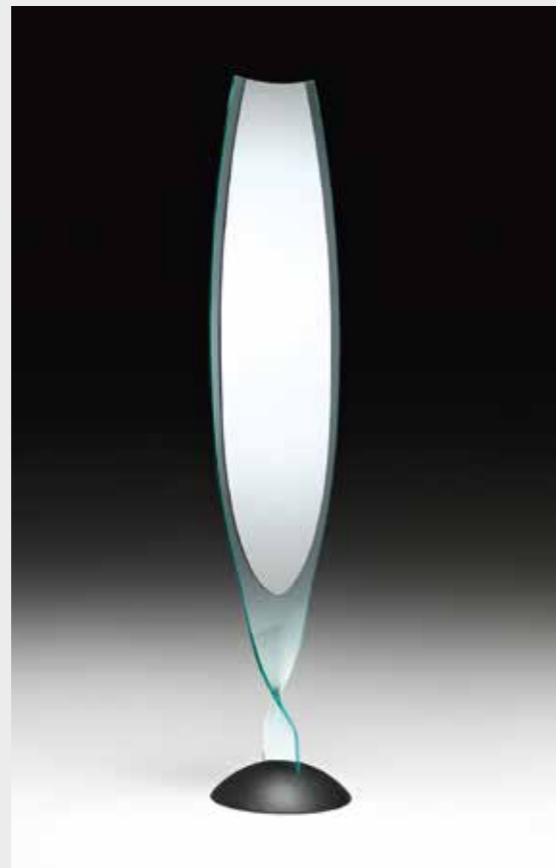

# caadre

DESIGN  
PHILIPPE STARCK



Specchio da terra  
o da parete in vetro  
da 6 mm formato  
da quattro elementi  
singoli curvati  
(versione neutra)  
disponibili anche con  
incisioni decorative  
(versione incisa) o in  
vetro semiriflettente  
color Titanio curvato  
da 6 mm (versione titanio).  
Telaio in metallo  
verniciato grigio  
metallizzato. Disponibile  
anche su misura e in  
configurazioni modulari.

E' possibile realizzare  
lo specchio Caadre  
su misura.

Also available  
in customized sizes.

Possibilité de réaliser  
le miroir sur mesure.

Der Spiegel kann nach  
Maß ausgeführt werden.

Free-standing mirror,  
also available in hanging  
version, in 6 mm-thick  
curved glass, made  
of four separate curved  
elements (neutral version)  
also available with  
engravings (engraved  
version), or semi-reflective  
glass titanium finishing  
6 mm-thick  
(titanium version).  
Metal grey-stained frame.  
Also available  
custom-sized and in  
modular configurations.

Miroir appuyant au mur  
et accrochable encadré  
par quatre éléments  
en verre cintré de 6 mm  
(version neutre),  
disponibles aussi  
avec engravures  
décoratives (version  
neutre gravée),  
en verre  
semi-réfléchissant  
couleur titane cintré  
de 6mm (version titane).  
Cadre en métal vernis  
gris métallisé. Disponible  
aussi sur mesure  
et en configurations  
modulaires.

Stand- bzw.  
Wandspiegel  
aus 6 mm-starkem  
gebogenem Glas,  
bestehend aus vier  
einzelnen Elementen,  
auch mit Gravüren  
lieferbar (gravierte  
Ausführung)  
oder aus 4 gebogenen  
halbreflektierenden,  
Titan-farbigen  
Glaselementen  
(Titan Ausführung).  
Metallrahmen  
metallgrau lackiert.  
Auch als Maßanfertigung  
lieferbar und in  
Modulen-Ausführungen.

105 x 13 x 195 cm  
41 5/8" x 5 1/8" x 76 3/4"

76 x 13 x 195 cm  
29 15/16" x 13 1/8" x 61"

195 x 13 x 195 cm  
76 3/4" x 13 1/8" x 76 3/4"

140 x 13 x 195 cm  
55 1/8" x 13 1/8" x 76 3/4"

105 x 13 x 155 cm  
41 1/3" x 13 1/8" x 41 1/3"

76 x 13 x 155 cm  
29 15/16" x 13 1/8" x 61"

140 x 13 x 140 cm  
55 1/8" x 13 1/8" x 55 1/8"

105 x 13 x 105 cm  
41 1/3" x 13 1/8" x 41 1/3"

155 x 13 x 240 cm  
61" x 5 1/8" x 94 1/2"

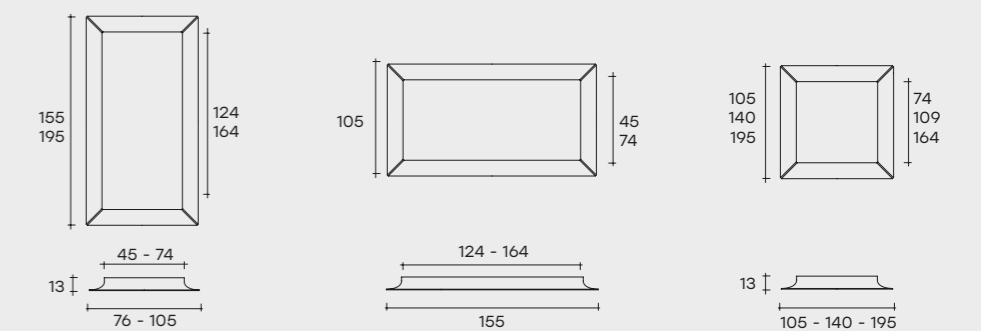
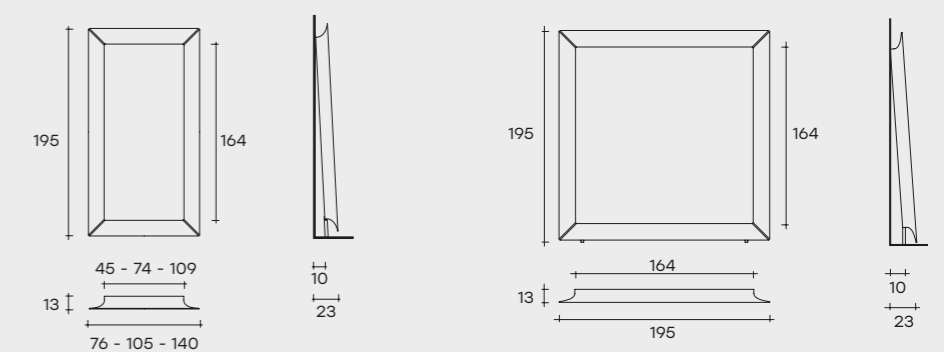

# caldeira

DESIGN  
XAVIER LUST



Specchio da parete  
in vetro fuso a gran fuoco  
da 8 mm retroargentato  
con decoro artistico  
a rilievo, specchio piano  
da 5 mm. Telaio  
posteriore in metallo  
verniciato. Possibilità  
di appendimento  
in diverse posizioni.

Wall mirror in 8 mm  
high-temperature fused  
glass with back silvered  
with artistic relief  
ornamentation  
5 mm flat mirror.  
Varnished metal back  
frame. Can be hung  
in various positions.

Miroir à accrocher  
en verre en fusion  
au grand feu de 8 mm  
argenté avec décoration  
artistique en relief,  
miroir plat de 5 mm.  
Cadre arrière en métal  
peint. Différentes  
positions d'accrochage.

Wandspiegel aus 8 mm  
starkem, geschmolzenem  
Glas, versilbert,  
mit künstlerischem  
Relief Dekor, flacher  
Spiegel 5 mm stark.  
Hinterer Rahmen  
aus lackiertem Metall.  
Kann in verschiedenen  
Stellungen  
aufgehängt werden.

Specchio ellittico  
Elliptical mirror  
Miroir elliptique  
Elliptischer Spiegel

104 x 5 x 235 cm  
41" x 2" x 92 1/2"

Specchio rotondo  
Round mirror  
Miroir rond  
Runder Spiegel

105 x 5 x 112 cm  
41 5/16" x 2" x 44 1/8"

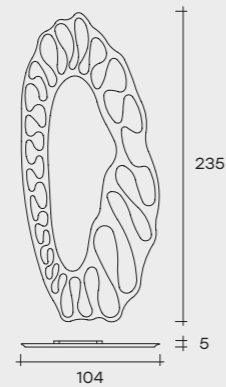

Possibili posizioni  
Possible positions  
Positions possibles  
Mögliche Stellungen

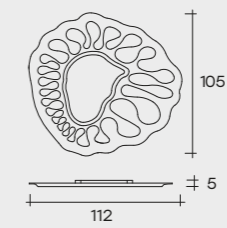
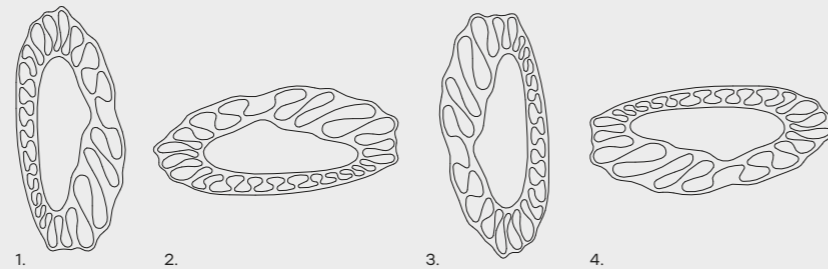

Possibili posizioni  
Possible positions  
Positions possibles  
Mögliche Stellungen

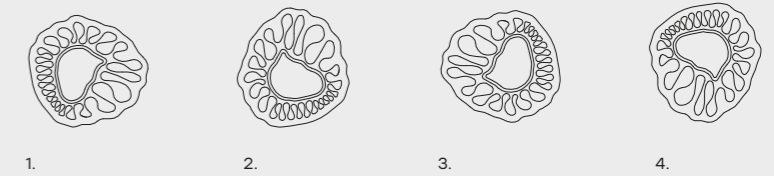

# christine

DESIGN HELIDON XHIXHA  
& DANTE O. BENINI - LUCA GONZO



Specchio da parete  
in vetro fuso da 6 mm  
retro argentato,  
specchio piano da 5 mm.  
Telaio posteriore  
in metallo verniciato.  
Possibilità  
di appendimento  
in diverse posizioni.

Wall mirror in 6 mm high  
temperature fused glass,  
back-silvered.  
5 mm flat mirror.  
Rear frame in painted  
metal. Can be hung  
in various positions.

Miroir à accrocher  
en verre en fusion  
de 6 mm argenté,  
miroir plat de 5 mm.  
Cadre arrière en métal  
verni. Différentes  
positions d'accrochage.

Wandspiegel aus  
geschmolzenem  
Glas versilbert.  
Flacher Spiegel 5 mm  
stark. Hinterer Rahmen  
aus lackiertem Metall.  
Kann in verschiedenen  
Stellungen  
aufgehängt werden.

Rettangolare  
Rectangular  
Rectangulaire  
Rechteckiger  
195 x 23 x 100 cm  
76 3/4" x 9" x 39 3/8"

Quadrato  
Square  
Carré  
Viereckig  
110 x 23 x 110 cm  
43 5/16" x 9" x 43 5/16"

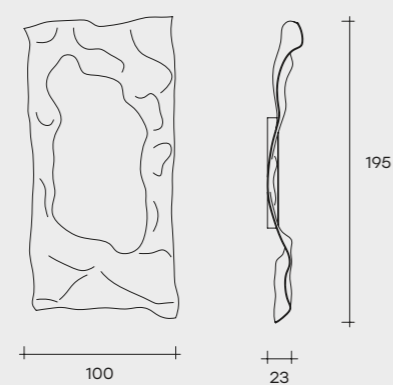

Possibili posizioni  
Possible positions  
Positions possibles  
Mögliche Stellungen

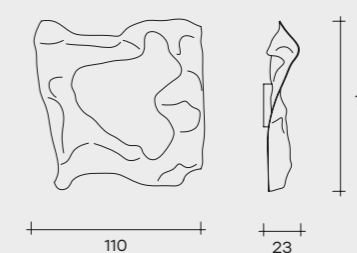
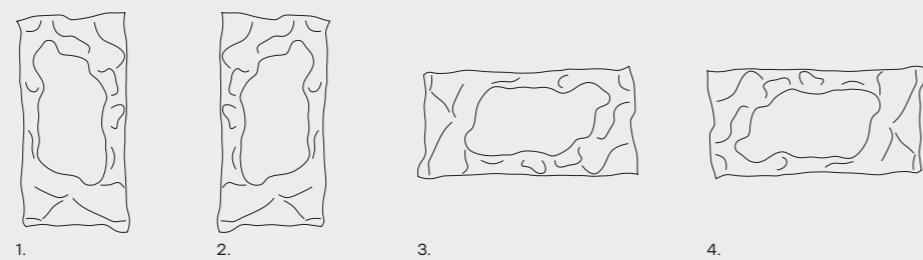

Possibili posizioni  
Possible positions  
Positions possibles  
Mögliche Stellungen

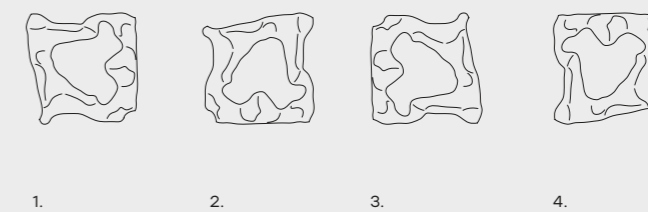

# dorian

DESIGN  
MASSIMO IOSA GHINI



Specchio con cornice  
in vetro fuso a gran fuoco  
da 6 mm retroargentato;  
specchio piano da 5 mm.  
Telaio posteriore  
in metallo verniciato.  
Possibilità  
di appendimento  
verticale od orizzontale.

Wall mirror in 6 mm high  
temperature fused glass,  
back-silvered;  
5 mm flat mirror.  
Rear frame  
in painted metal.  
It can be hung  
horizontally or vertically.

Miroir à accrocher  
en verre en fusion  
de 6 mm argenté;  
miroir plat de 5 mm.  
Cadre arrière  
en métal verni.  
Possibilité d'accrochage  
en horizontal ou vertical.

Wandspiegel aus  
geschmolzenem  
Glas versilbert; flacher  
Spiegel 5 mm stark.  
Hinterer Rahmen  
aus lackiertem Metall.  
Kann sowohl horizontal  
als auch vertikal  
aufgehängt werden.

202 x 10 x 105 cm  
79 1/2" x 4" x 41 5/16"  
120 x 10 x 80 cm  
47 1/4" x 4" x 31 1/2"

# hasami

DESIGN  
PAOLO RIZZATTO



Specchio da parete  
in vetro curvato  
argentato da 6 mm  
orientabile tramite  
snodo posteriore  
in acciaio inox.

Wall mirror in 6 mm-thick  
curved silver-backed  
glass. The articulated  
rear joint in stainless  
steel allows the mirror to  
be angled as preferred.

Miroir accrochable  
en verre cintré de 6 mm.  
Le joint postérieur  
en acier inox permet  
un positionnement  
personnalisé.

Wandspiegel aus  
6 mm-starkem  
gebogenem Glas.  
Der an der Rückseite  
angebrachte  
Mechanismus aus  
rostfreiem Stahl  
ermöglicht eine  
individuelle Ausrichtung  
und Befestigung.

Ø 96 x 17 cm  
37 3/4" x 6 11/16"

90 x 18 x 90 cm  
35 7/16" x 7 1/16" x 35 7/16"

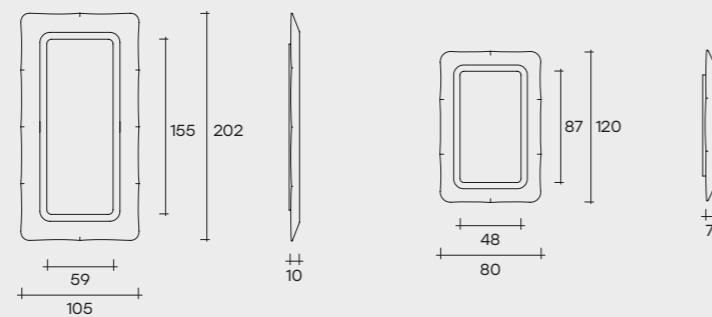

Possibili posizioni  
Possible positions  
Positions possibles  
Mögliche Stellungen

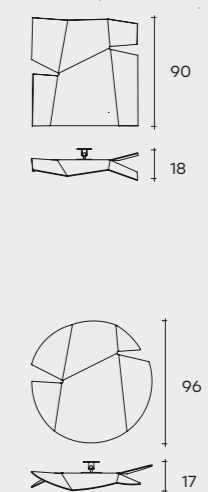
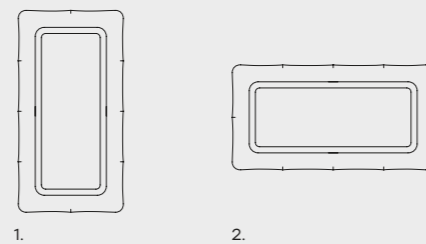

# hiroshi

DESIGN MARTA LAUDANI,  
ROBERTO ROMANELLI



Specchio da parete  
in vetro curvato da 6 mm.  
Il telaio metallico posteriore  
consente il ssaggio  
a scelta su ogni lato.

Wall mirror in 6 mm-thick  
curved silver-backed  
glass. The back metal  
frame allows any  
positioning on any side.

Miroir accrochable  
en verre cintré de 6 mm.  
Le cadre postérieur  
en métal permet de choisir  
le positionnement  
sur tous côtés.

Wandspiegel aus  
6 mm-starkem  
gebogenem Glas.  
Der hintere Metallrahmen  
ermöglicht eine freie Wahl  
der Wandbefestigung.

180 x 8 x 55 cm  
70 7/8" x 3 1/8" x 21 5/8"

100 x 8 x 100 cm  
39 3/8" x 3 1/8" x 39 3/8"

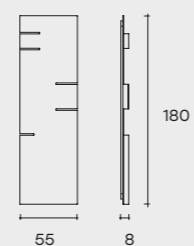
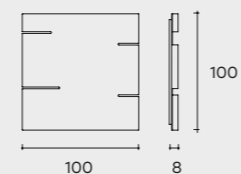

# let me see

DESIGN  
RODOLFO DORDONI

Specchio consolle  
con ripiano in vetro  
curvato da 8 mm.  
Cornice in acciaio  
inox satinato.

Mirror console  
in 8 mm-thick  
curved glass.  
Frame in glazed  
stainless steel.

Miroir console  
avec étagère  
en verre cintré  
de 8 mm.  
Cadre en acier  
inox satiné.

Spiegel Konsole mit  
Ablage aus 8 mm-starkem  
gebogenem Glas.  
Rahmen aus rostfreiem  
satinierem Stahl.

120 x 36 x 195 cm  
47 1/4" x 14 3/16" x 76 3/4"

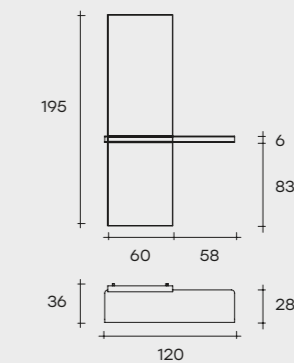

# lucy

DESIGN DORIANA  
E MASSIMILIANO FUKSAS



Specchio da parete  
in vetro fuso da 8 mm  
retroargentato,  
specchio piano da 5 mm.  
Pannello di fissaggio  
posteriore con possibilità  
di appendimento  
in diverse posizioni.

Wall mirror in 8 mm  
fused glass back silvered;  
5 mm flat mirror.  
Rear mounting panel  
allowing hanging  
in various positions.

Miroir à accrocher  
en verre en fusion  
de 8 mm argenté,  
miroir plat de 5 mm.  
Panneau de fixation  
arrière avec différentes  
positions d'accrochage.

Wandspiegel aus 8 mm  
starkem, geschmolzenem  
Glas versilbert, flacher  
Spiegel 5 mm. An der  
Rückseite Montageplatte  
zum Aufhängen in  
verschiedenen Stellungen.

153 x 10 x 117 cm  
60 1/4" x 4" x 46"

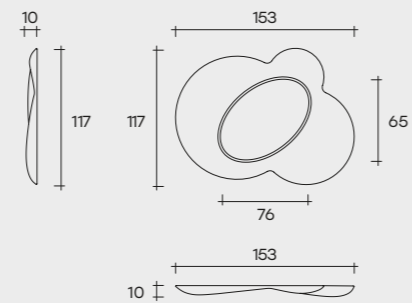

Possibili posizioni  
Possible positions  
Positions possibles  
Mögliche Stellungen

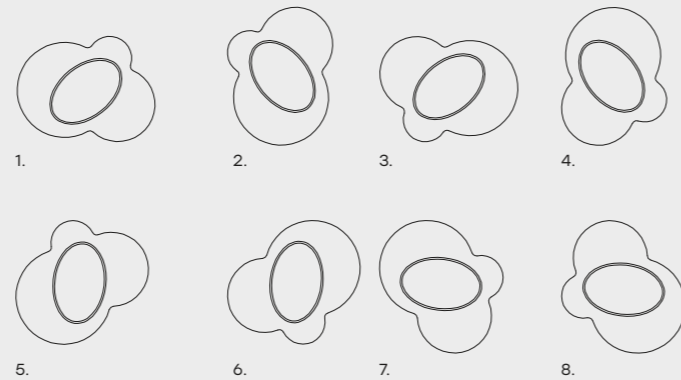

# mary

DESIGN DORIANA  
E MASSIMILIANO FUKSAS



Specchio da parete  
in vetro fuso da 8 mm  
retroargentato,  
specchio piano da 5 mm.  
Pannello di fissaggio  
posteriore con possibilità  
di appendimento  
in diverse posizioni.

Wall mirror in 8 mm  
fused glass back silvered;  
5 mm flat mirror.  
Rear mounting panel  
allowing hanging  
in various positions.

Miroir à accrocher  
en verre en fusion  
de 8 mm argenté,  
miroir plat de 5 mm.  
Panneau de fixation  
arrière avec différentes  
positions d'accrochage.

Wandspiegel aus 8 mm  
starkem, geschmolzenem  
Glas versilbert, flacher  
Spiegel 5 mm. An der  
Rückseite Montageplatte  
zum Aufhängen in  
verschiedenen Stellungen.

120 x 10 x 180 cm  
47 1/4" x 4" x 70 7/8"

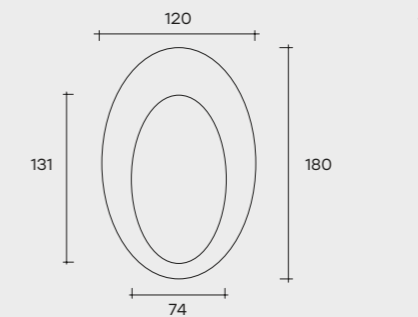

Possibili posizioni  
Possible positions  
Positions possibles  
Mögliche Stellungen

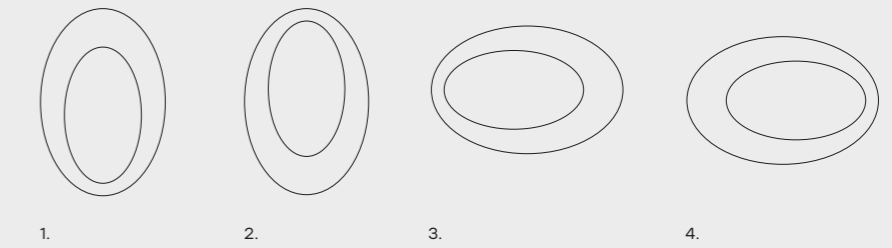

# mir

DESIGN  
ROBERTO PAOLI

Specchio da terra girevole, con scocca in vetro curvato a gran fuoco argentato da 6 mm, telaio interno in acciaio verniciato, base a specchio da 8 mm saldata su piatto in acciaio verniciato.

Free-standing rotating mirror consisting in a 6 mm-thick curved mirrored-glass frame, internally supported by a lacquered steel structure, base composed of a 8 mm-thick mirror jointed to a lacquered steel plate.

Miroir au sol tournant en verre cintré en fusion de 6 mm; cadre intérieur supportant en acier verni; base en miroir de 8 mm soudée sur plat en acier.

Drehbarer Standspiegel aus 6 mm-starkem, bei hohen Temperaturen geschmolzenem Glas. Innere stützende Struktur aus gebeiztem Stahl. Spiegel Basis, 8 mm stark, verschweißt auf einem Stahlplatte.

53 x 198 cm  
20 7/8" x 77 15/16"

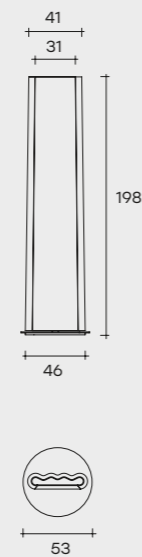

# mir lampada

DESIGN  
ROBERTO PAOLI

Specchio-lampada da terra girevole con scocca in vetro curvato a gran fuoco argentato da 6 mm. Telaio interno in acciaio verniciato, base a specchio da 8 mm saldata su piatto in acciaio verniciato. Provvisto di kit illuminazione interna.

Revolving mirror-standing lamp with 6 mm high temperature curved silvered glass frame. Inside supporting mount in painted steel, base composed of a 8 mm thick mirror jointed to a lacquered steel plate. Lighting kit inside.

Miroir-lampadaire pivotant avec coque en verre cintré en fusion argenté de 6 mm. Cadre interne en acier verni, base en miroir de 8 mm soudée sur plat en acier. Kit éclairage interne.

Drehbares Spiegel-Stehlampenelement mit bei sehr hohen Temperaturen versilberter, 6 mm starker gebogener Glas. Spiegel Basis, 8 mm stark, verschweißt auf einem Stahlplatte. Integrierter Beleuchtung.

Ø 53 x 198 cm  
Ø 20 7/8" x 77 15/16"

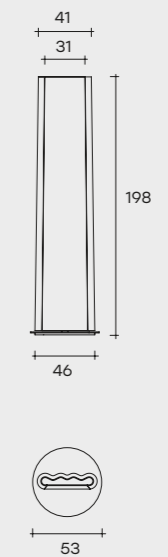

# mirage

DESIGN  
DANIEL LIBESKIND



Specchio da parete con cornice in alluminio finitura brill. Lo specchio offre sia un'ampia gamma di misure che un'ampia possibilità di customizzazione.

Wall mirror with brill finish aluminium frame. The mirror is available in a wide range of sizes and offers several customization solutions.

Miroir à accrocher avec cadre en aluminium finition brill. Le miroir offre un vaste assortiment de mesures et une large gamme de personnalisation.

Wandspiegel mit Rahmen Finish geglänztes Aluminium. In vielen verschiedenen Größen und Personalisierungen.

Specchio quadrato e rettangolare  
Square and rectangular mirror  
Miroir carré et rectangulaire  
Viereckig und Rechteckig  
Wandspiegel

Specchio sagomato  
Shaped mirror  
Miroir façonné  
Wandspiegel mit abgerundeten Seiten

70 x 5 x 70 cm  
27 <sup>9</sup>/<sub>16</sub>" x 2" x 27 <sup>9</sup>/<sub>16</sub>"

mod. A  
63 x 5 x 152 cm  
24 <sup>13</sup>/<sub>16</sub>" x 2" x 59 <sup>13</sup>/<sub>16</sub>"

90 x 5 x 90 cm  
35 <sup>7</sup>/<sub>16</sub>" x 2" x 35 <sup>7</sup>/<sub>16</sub>"

mod. B  
61 x 5 x 135 cm  
24" x 2" x 53 <sup>1</sup>/<sub>8</sub>"

120 x 5 x 40 cm  
47 <sup>1</sup>/<sub>4</sub>" x 2" x 15 <sup>3</sup>/<sub>4</sub>"

mod. C  
64 x 5 x 100 cm  
25 <sup>3</sup>/<sub>16</sub>" x 2" x 39 <sup>3</sup>/<sub>8</sub>"

160 x 5 x 50 cm  
62" x 2" x 19 <sup>11</sup>/<sub>16</sub>"

mod. D  
83 x 5 x 121 cm  
32 <sup>11</sup>/<sub>16</sub>" x 2" x 47 <sup>5</sup>/<sub>8</sub>"

200 x 5 x 60 cm  
78 <sup>3</sup>/<sub>4</sub>" x 2" x 23 <sup>5</sup>/<sub>8</sub>"

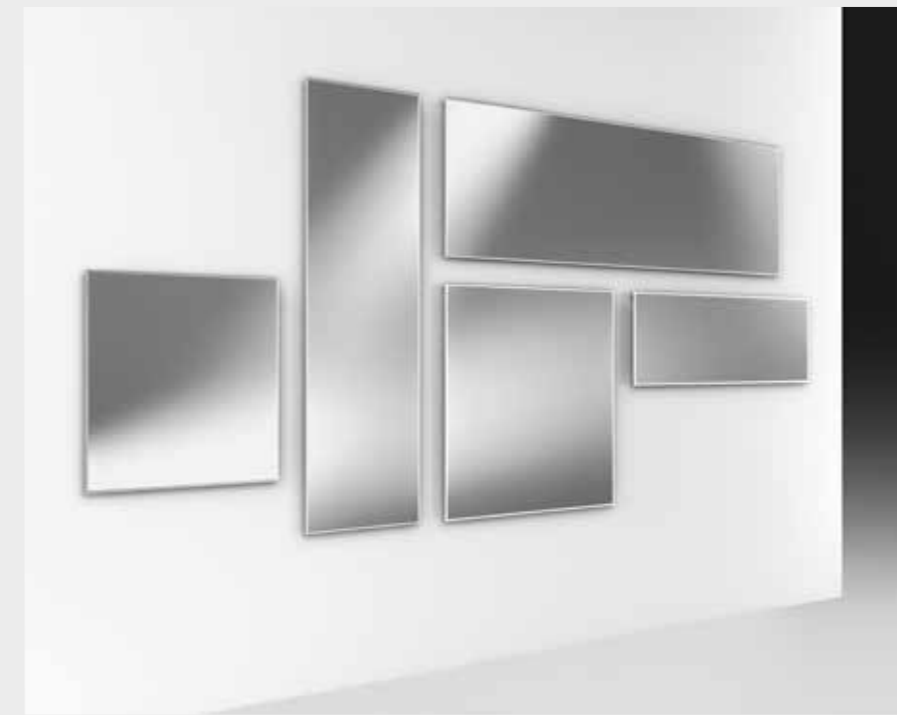
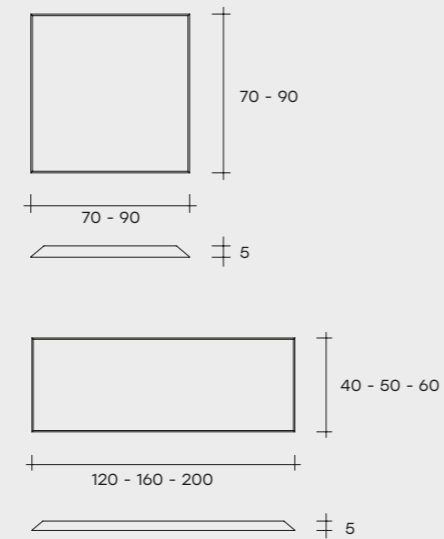
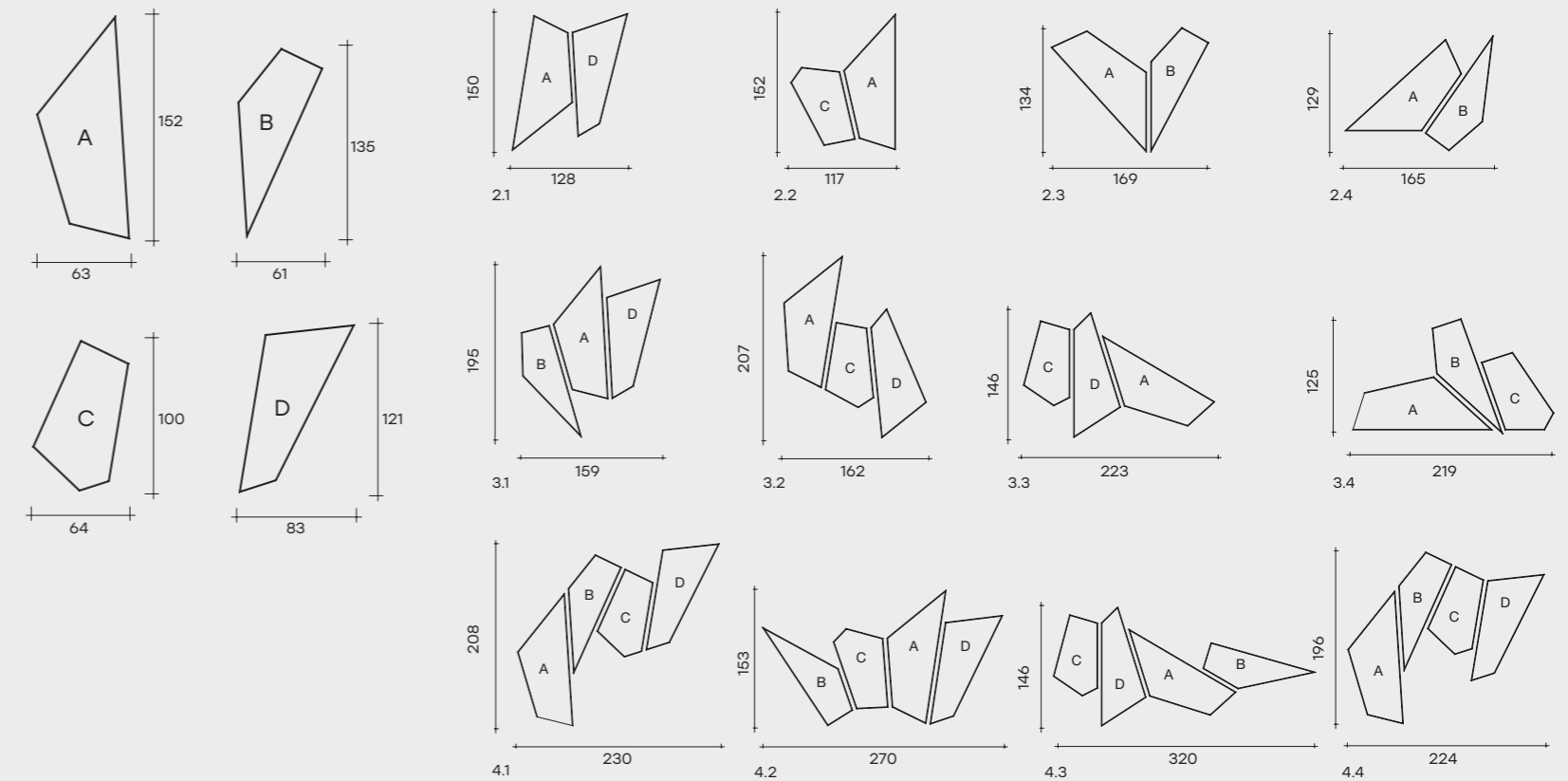



# phantom

DESIGN HELIDON XHIXHA  
& DANTE O. BENINI - LUCA GONZO



Specchio da parete  
in vetro fuso da 6 mm  
retro argentato,  
specchio piano da 5 mm.  
Telaio posteriore  
in metallo verniciato.  
Possibilità  
di appendimento  
in diverse posizioni.

Wall mirror in 6 mm high  
temperature fused glass,  
back-silvered.  
5 mm flat mirror.  
Rear frame in painted  
metal. Can be hung  
in various positions.

Miroir à accrocher  
en verre en fusion  
de 6 mm argenté,  
miroir plat de 5 mm.  
Cadre arrière en métal  
verni. Différentes  
positions d'accrochage.

Wandspiegel aus  
geschmolzenem  
Glas versilbert.  
Flacher Spiegel 5 mm  
stark. Hinterer Rahmen  
aus lackiertem Metall.  
Kann in verschiedenen  
Stellungen  
aufgehängt werden.

Ovale / Oval  
Ovale / Oval  
180 x 16 x 90 cm  
70 7/8" x 6 5/16" x 35 7/16"

Rettangolare / Rectangular  
Rectangulaire / Rechteckiger  
190 x 15 x 90 cm  
76 3/4" x 5 7/8" x 35 7/16"

198 x 18 x 98 cm  
78" x 7" x 38 9/16"

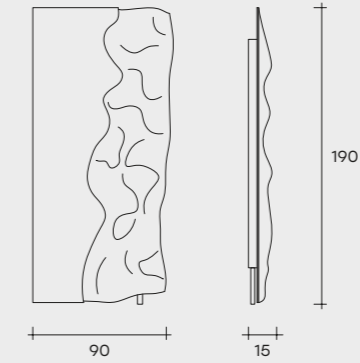

Possibili posizioni  
Possible positions  
Positions possibles  
Mögliche Stellungen

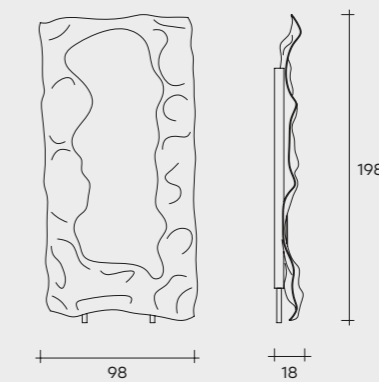
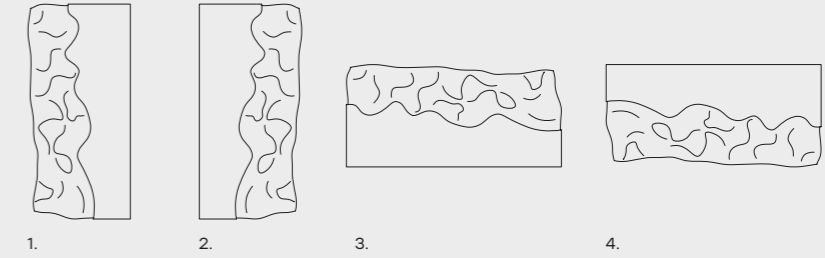

Possibili posizioni  
Possible positions  
Positions possibles  
Mögliche Stellungen

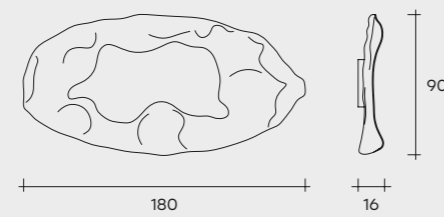
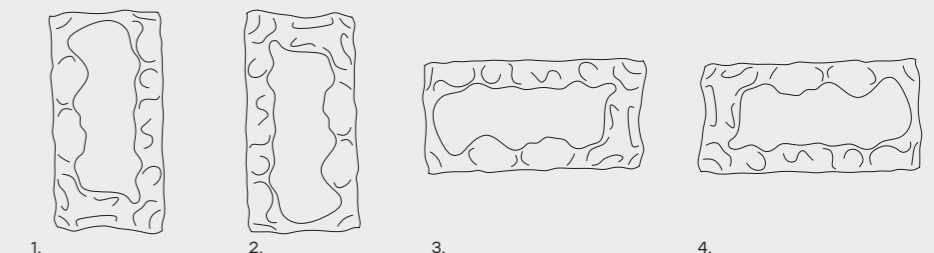

Possibili posizioni  
Possible positions  
Positions possibles  
Mögliche Stellungen

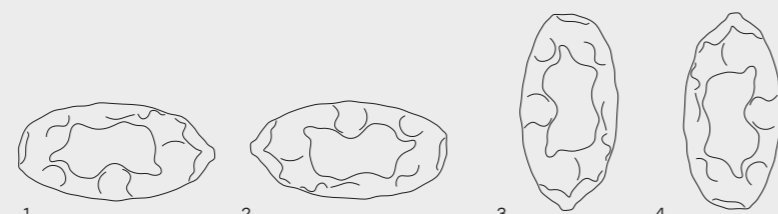

## reverso

DESIGN  
MARZIA E LEO DAINELLI



Specchio da parete  
in vetro saldato da 6 mm  
con elemento centrale  
in vetro Nero95.

L'inclinazione delle superfici  
dello specchio permette  
una riflessione del soggetto  
specchiato secondo  
più punti di vista.

Wall mirror in 6 mm welded  
glass with Black95 glass  
central element.

The angle of the mirror's  
surfaces reflects  
the object from several  
points of view.

Miroir à accrocher  
en verre soudé de 6 mm  
avec élément central  
en verre Noir95.

L'inclinaison des surfaces  
du miroir permet une  
réflexion du sujet sous  
différents angles de vue.

Wand-Spiegel aus 6 mm  
starkem Glas mit Inlay  
aus Glas Schwarz95.

Durch die unterschiedliche  
Neigung der einzelnen  
Flächen kann das  
Spiegelbild aus  
unterschiedlichen  
Perspektiven  
betrachtet werden.

180 x 16 x 70 cm  
70 7/8" x 6 5/16" x 27 9/16"

100 x 16 x 70 cm  
39 3/8" x 6 5/16" x 27 9/16"

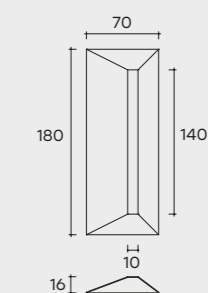
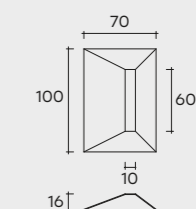

# ritratto

DESIGN MARTA LAUDANI  
MARCO ROMANELLI



Specchio da parete con cornice in legno applicata direttamente sulla superficie specchiante. La cornice in stile barocco, può essere singola tonda o doppia ellittica, finiture oro ed argento.

Wall mirror with wooden frame mounted directly on the mirror surface. Available with one round frame or double elliptical, Baroque style, gold and silver finishes.

Miroir à accrocher avec cadre en bois appliqué directement sur le miroir. Le cadre style baroque est disponible rond dans les finitions or et argent, ou double elliptique dans mes finitions.

Wandspiegel mit direkt auf der Spiegelfläche angebrachtem Holzrahmen. Mit rundem Rahmen oder mit doppeltem elliptischem Rahmen, Barockstil, Finish Gold oder Silber.

110 x 5 x 110 cm  
43 5/16" x 2" x 43 5/16"  
Con cornice applicata tonda diam. 60 cm  
With round frame diam. 60 cm  
Avec cadre appliqué rond diam. 60 cm  
Mit aufgesetztem, rundem Rahmen Durchm. 60 cm

150 x 5 x 70 cm  
59" x 2" x 27 9/16"  
Con doppia cornice applicata ellittica 55 x 48 cm  
With double elliptical frame 55 x 48 cm  
Avec double cadre appliqué elliptique 55 x 48 cm  
Mit aufgesetztem, doppeltem elliptischem Rahmen 55 x 48 cm

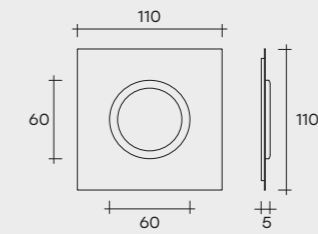
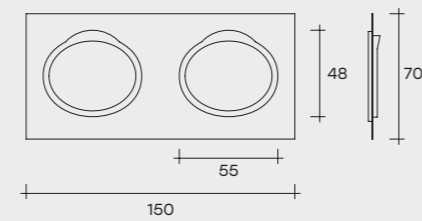

# rosy

DESIGN DORIANA  
E MASSIMILIANO FUKSAS



Specchio da parete  
in vetro fuso da 8 mm  
retroargentato,  
specchio piano da 5 mm.  
Pannello di fissaggio  
posteriore con possibilità  
di appendimento  
in diverse posizioni.

Wall mirror in 8 mm  
fused glass back silvered;  
5 mm flat mirror.  
Rear mounting panel  
allowing hanging  
in various positions.

Miroir à accrocher  
en verre en fusion  
de 8 mm argenté,  
miroir plat de 5 mm.  
Panneau de fixation  
arrière avec différentes  
positions d'accrochage.

Wandspiegel aus 8 mm  
starkem, geschmolzenem  
Glas versilbert, flacher  
Spiegel 5 mm. An der  
Rückseite Montageplatte  
zum Aufhängen in  
verschiedenen Stellungen.

Ø 100 x 10 cm  
Ø 39 3/8" x 4"

Ø 130 x 10 cm  
Ø 51 3/16" x 4"

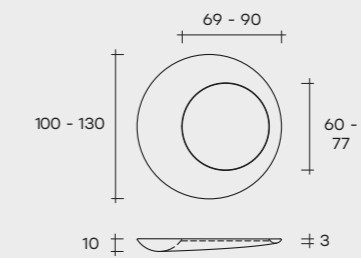

Possibili posizioni  
Possible positions  
Positions possibles  
Mögliche Stellungen

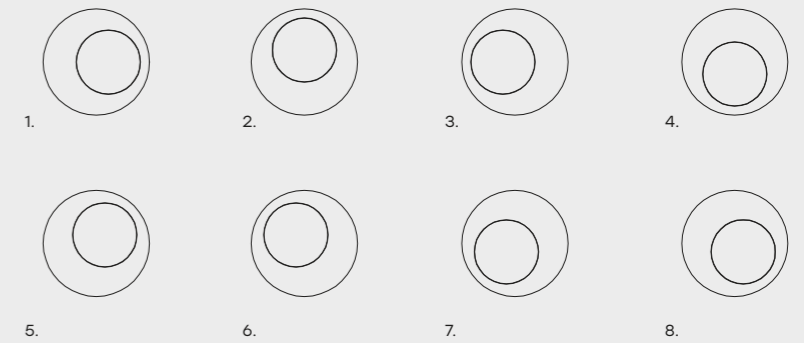

# the wing

DESIGN  
DANIEL LIBESKIND



Specchio da parete  
composto da due  
elementi in vetro curvato  
retroargentato da 6 mm  
e da tre specchi piani  
da 6 mm saldati tra loro.  
Telaio posteriore  
in metallo con possibilità  
di appendamento  
in orizzontale,  
verticale ed obliquo.

Wall mirror consisting  
of two 6 mm curved  
back-silvered glass  
elements and three  
flat mirrors of 6 mm  
welded together. Metal  
back frame allowing  
horizontal, vertical  
and slanted hanging.

Miroir à accrocher  
constitué de deux  
éléments en verre  
cintré argenté de 6 mm  
et de trois miroirs plats  
de 6 mm soudés  
entre eux. Cadre  
arrière en métal pour  
accrochage horizontal,  
vertical ou oblique.

Wandspiegel aus zwei  
6 mm starken, gebogenen  
Glaselementen versilbert  
und drei 6 mm starken,  
miteinander verschweißten  
Flachspiegeln. An der  
Rückseite ein Metallrahmen  
zum Aufhängen in  
waagrecht, senkrecht  
und schräger Stellung.

Specchio ellittico  
Elliptical mirror  
Miroir elliptique  
Elliptischer Spiegel

180 x 10 x 65 cm  
70 7/8" x 4" x 25 9/16"

Specchio rettangolare  
con angolo  
Rectangular mirror  
with corner  
Miroir rectangulaire  
avec coin  
Rechteckiger Spiegel  
mit Abschrägung

200 x 10 x 53 cm  
78 3/4" x 4" x 20 7/8"

Specchio rettangolare  
Rectangular mirror  
Miroir rectangulaire  
Rechteckiger Spiegel

200 x 10 x 53 cm  
78 3/4" x 4" x 20 7/8"

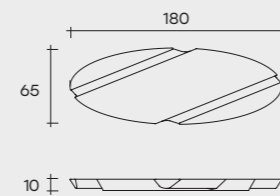

Possibili posizioni  
Possible positions  
Positions possibles  
Mögliche Stellungen

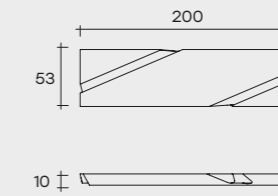
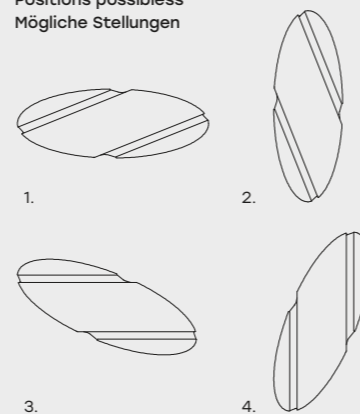

Possibili posizioni  
Possible positions  
Positions possibles  
Mögliche Stellungen

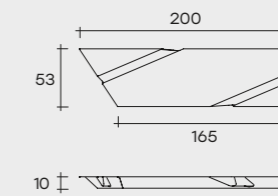
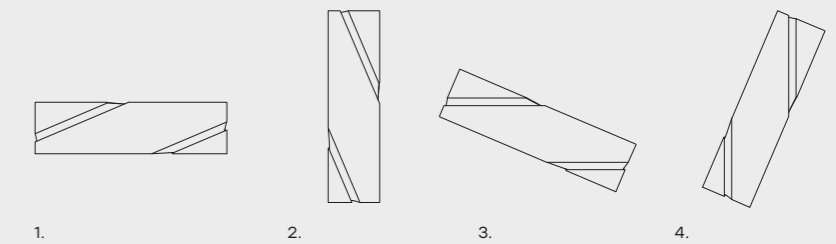

Possibili posizioni  
Possible positions  
Positions possibles  
Mögliche Stellungen

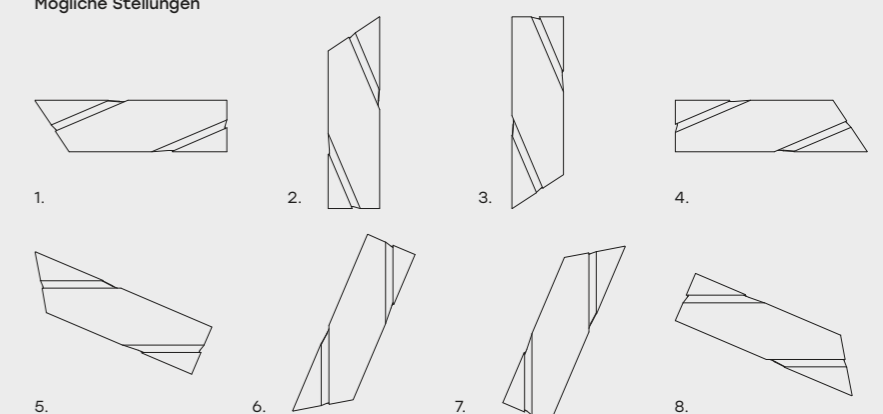

## venus

DESIGN  
VITTORIO LIVI



Collezione di specchi  
in vetro fuso a gran fuoco  
da 8 mm retro argentato  
con decoro artistico  
a rilievo, specchio piano  
da 4 mm, telaio posteriore  
in metallo verniciato.

Collection of mirrors  
in 8 mm high-temperature  
fused glass with  
silvered back.  
Relief ornamentation  
on frame, flat mirror  
4 mm thick, painted  
metal rear frame.

Collection de miroirs  
en verre en fusion  
de 8 mm arrière argenté  
avec décoration artistique  
en relief, miroir plat  
de 4 mm, cadre arrière  
en métal verni.

Kollektion von Spiegeln  
aus bei sehr hohen  
Temperaturen  
geschmolzenem,  
8 mm starkem, hinten  
versilbertem Glas,  
mit edlem Reliefdekor.  
Flacher Spiegel, 4 mm  
Stärke. Rückwärtiger  
Rahmen aus Metall.

rettangolare / rectangular  
rectangulaire / rechteckig  
200 x 105 cm  
78 3/4" x 42 5/16"  
(versione a parete e da terra  
wall mounted and floor standing  
version à accrocher et à appuyer  
Stand- bzw. Wandspiegel)

200 x 71 cm  
78 3/4" x 27 9/16"

quadrato / square  
carré / viereckig  
105 x 105 cm  
42 5/16" x 42 5/16"

rotondo / round  
rond / rund  
Ø 126 cm  
49 5/8"

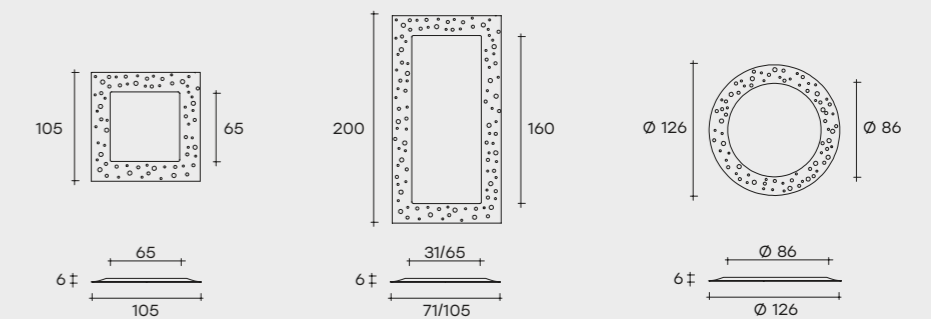

## caadre tv

DESIGN  
PHILIPPE STARCK



Specchio con televisore incorporato. Specchio da parete in vetro semiriflettente da 5 mm color titanio, formato da 4 elementi singoli curvati in vetro semiriflettente da 6 mm color titanio e retroverniciato nero. Telaio in metallo verniciato nero opaco.

Mirror with integral television. Wall mirror in 5 mm semi-reflective glass, titanium colour made of 4 separate curved elements in 6 mm semi-reflective glass titanium colour, backpainted black. Metal frame painted matt black.

Miroir avec poste TV incorporé. Miroir accrochable en verre semi-réfléchissant de 5 mm couleur titane formé de 4 éléments séparés cintrés en verre semi-réfléchissant de 6 mm couleur titane et peint dessous noir. Structure en métal peint noir mat.

Spiegel mit eingebautem TV-Gerät. Wandspiegel aus halbreflektierendem, 5 mm starkem Glas in der Farbe Titan, gebildet aus 4 einzelnen gebogenen Elementen mit halbreflektierendem, 6 mm starkem Glas in der Farbe Titan, rückseitig schwarz lackiert. Der Rahmen ist aus Metall und mit Schwarz matt lackiert.

155 x 20 x 140 cm  
61" x 7 7/8" x 55 1/8"

195 x 20 x 140 cm  
76 3/4" x 7 7/8" x 55 1/8"

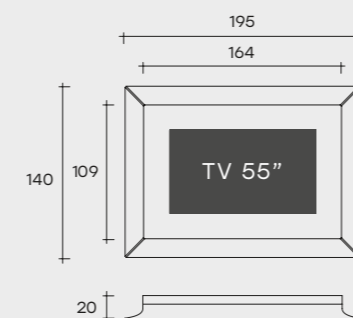
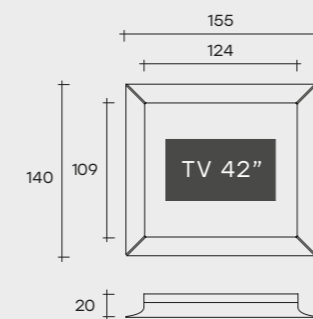

## mirage tv

DESIGN  
DANIEL LIBESKIND



Specchio con alloggiamento per televisore. Specchio da parete in vetro semiriflettente da 5 mm color titanio con retrocornice in alluminio finitura brill. Telaio in metallo verniciato nero opaco. Televisore non in dotazione.

Mirror with built-in frame to accommodate a TV set. Wall mirror in 5 mm semi-reflecting glass, titanium-colour, with rear frame in polished aluminium. Casing in matt black painted metal. TV set not included.

Miroir avec poste pour téléviseur. Miroir à accrocher en verre semi-réfléchissant de 5 mm couleur titane avec cadre arrière en aluminium finition brillante. Cadre en métal verni noir mat. Téléviseur non fourni.

Spiegel zur eingebautem Fernseher vorbereitet. Wandspiegel aus halbreflektierendem Glas von 5 mm Stärke, titanfarben, Rückseite aus Aluminium Hochglanzfinish, matt schwarz lackierter Metallrahmen. Der Fernseher wird nicht mitgeliefert.

160 x 10 x 90 cm  
62" x 4" x 35 7/16"  
Specchio per TV 42"  
42" TV mirror  
Miroir pour TV 42"  
Spiegel für 42" Fernseher

160 x 10 x 100 cm  
62" x 4" x 39 3/8"  
Specchio per TV 55"  
55" TV mirror  
Miroir pour TV 55"  
Spiegel für 55" Fernseher

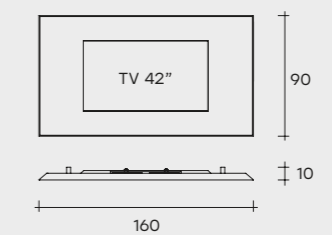
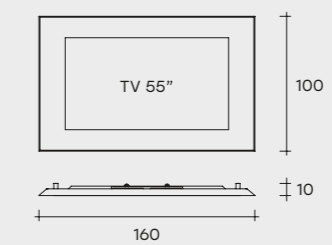

## aura

DESIGN  
PATRICK JOUIN



Vetrina elettrificata con corpo in vetro curvato da 6 mm e tre ripiani fissi in vetro da 8 mm. Reggipiani posteriori in vetro, saldati al corpo vetrina. Top in vetro da 10 mm e base in legno laccato nero opaco. Profili e piedini in alluminio verniciato nero opaco. Anta con serratura. Illuminazione LED posizionata all'interno dei profili di alluminio.

Wired showcase in 6 mm curved glass with three 8 mm fixed glass shelves. Shelf supports in glass welded to the showcase. 10 mm glass top and base in matt black lacquered wood. Profiles and feet in matt black lacquered aluminium. Door with lock. LED lighting positioned in the aluminium profiles.

Vitrine électrifiée en verre cintré de 6 mm avec trois étagères fixes en verre de 8 mm. Supports d'étagère en verre, soudés à la structure. Top en verre de 10 mm et base en bois laqué noir mat. Profils et pieds en aluminium verni noir mat. Porte avec serrure. Éclairage LED positionné à l'intérieur des profils en aluminium.

Vitrine aus 6 mm starkem gebogenem Glas mit drei festen Fachböden aus 8 mm starkem Glas. Hintere Fachbodenhalterungen aus Glas an den Vitrinenkasten geschweißt. Deckplatte aus 10 mm starkem Glas und Sockel aus mattschwarz lackiertem Holz. Profile und Füße aus mattschwarz lackiertem Aluminium. Tür mit Schloss. LED-Beleuchtung im Innern der Aluminiumprofile.

100 x 37 x 181 cm  
39 3/8" x 14 9/16" x 71 1/4"

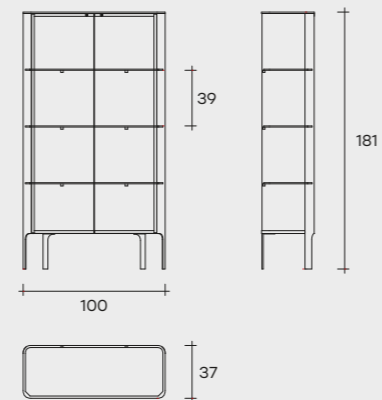

## babele

DESIGN  
MASSIMO MOROZZI



Espositore in vetro curvato da 10 mm, con ripiani fissi bisellati da 10 mm. Disponibile anche in vetro extralight.

Display unit in 10 mm-thick curved glass with welded and bevelled 10 mm-thick glass shelves. Also available in extralight glass.

Rangement en verre cintré de 10 mm avec étagères fixes biseautées de 10 mm. Disponible aussi en verre extralight

Regal aus 10 mm-starkem gebogenem Glas. Feste 10 mm-starke Glasfachböden mit geschliffenem Rand und verklebt. Lieferbar auch aus extralight-Glas.

50 x 50 x 204 cm  
19 1/16" x 19 1/16" x 80 5/16"

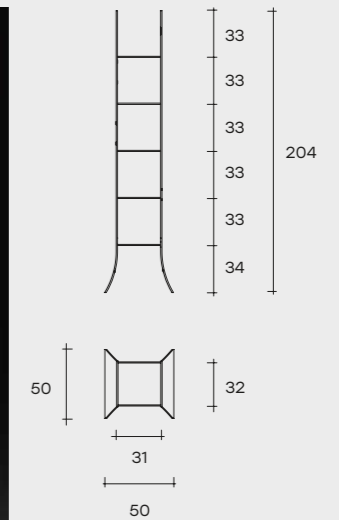



## magique totem

DESIGN  
STUDIO KLASS

Espositore con cubi contenitori in vetro saldato da 10 mm. Disponibile in diverse finiture: struttura in vetro extralight, contenitori in vetro bianco opale o in vetro fumé; espositore con struttura in vetro fumé, contenitori in vetro Nero95.

Display cabinet with container cubes in 10 mm welded glass. Available in various finishes: cabinet with extralight glass structure, opal white glass containers or smoked grey glass containers; smoked grey glass structure, Black95 glass containers.

Présentoir avec des cubes de rangement en verre soudé de 10 mm. Disponible en plusieurs finitions: structure en verre extralight, rangements en verre blanc opale ou en verre fumé; structure en verre fumé, rangements en verre Noir95.

Regal mit geschweißten Glasbehälter 10 mm stark, Lieferbar in diversen Finishes: Struktur aus Extralight-Glas, Behälter aus weißem Opalglas oder aus Rauchglas; Struktur aus Rauchglas, Behälter aus schwarzem Glas Schwarz95.

38 x 38 x 172 cm  
15" x 15" x 67 11/16"

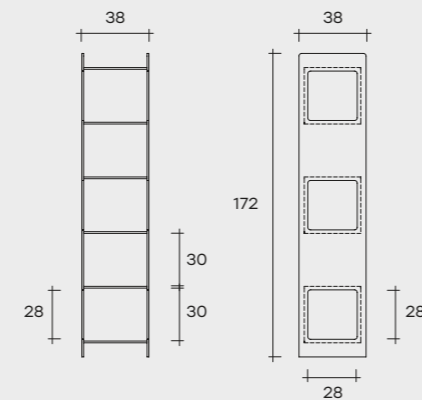

## milo day

DESIGN  
ILARIA MARELLI



Vetrina in vetro curvato da 8 mm trasparente, anta in vetro da 6 mm trasparente con serratura, quattro ripiani fissi in vetro da 8 mm reggipiani in vetro saldati alla struttura. Base in vetro da 12 mm disponibile in vetro extralight acidato retroverniciato bianco o in extralight argentato. Top in vetro da 12 mm. Profili in alluminio brillante. Predisposta per il kit di illuminazione.

Showcase in curved transparent glass 8 mm-thick, door in 6 mm-thick transparent glass with lock, glass shelves and supports. Base in 12 mm-thick glass, available extralight acid-etched white back-stained or extralight mirror-finish. Top in 12 mm-thick glass. Polished aluminum profiles. Four fix-positioned shelves in 8 mm-thick glass. Fitted for a lighting kit.

Vitrine composée d'une structure en verre cintré de 8 mm transparent et porte avec serrure en verre transparent de 6 mm. Top en verre de 12 mm. Quatre étagères fixes en verre de 8 mm et supports-étagères en verre soudés à la structure; base en verre de 12 mm disponible en verre extralight dépoli verni dessous blanc ou en verre extralight argenté. Profils en aluminium finition brill. Equipée pour un kit d'éclairage.

Vitrine aus 8 mm-starkem gebogenem transparentem Glas, Tür mit Schloß aus 6 mm-starkem transparentem Glas. Deckplatte aus 12 mm starkem Glas. Vier feste Fachböden aus 8 mm-starkem Glas. Sockel, 12 mm Stärke, aus extralight, geätzttem weiß- hinterlackiertem Glas oder aus extralight versilbertem Glas. Profile aus poliertem Aluminium. Ausgerüstet für ein Beleuchtungsset.

59 x 37 x 174  
23" x 14 9/16" x 68 1/2"

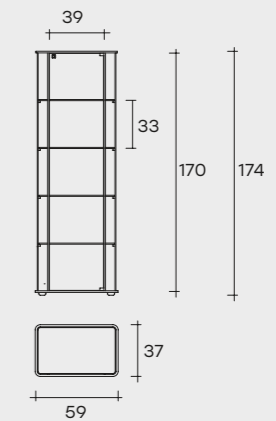

## milo day led

DESIGN  
ILARIA MARELLI

Vetrina in vetro curvato da 8 mm trasparente, anta in vetro da 6 mm trasparente con serratura, quattro ripiani fissi in vetro da 8 mm reggipiani in vetro saldati alla struttura. Base in vetro da 12 mm disponibile in vetro extralight acidato e retroverniciato bianco o in extralight argentato. Top in vetro da 12 mm. Profili in alluminio brillantato. Dei 4 ripiani in dotazione 2 sono dotati di illuminazione a led alimentati da 1 trasformatore regolatore.

59 x 37 x 174  
23" x 14 9/16" x 68 1/2"

Showcase in curved transparent glass 8 mm-thick, door in 6 mm-thick transparent glass with lock, glass shelves and supports. Base in 12 mm-thick extralight glass, available acid-etched white back-stained or extralight mirror-finish. Top in 12 mm-thick glass. Polished aluminum profiles. Four fix-positioned shelves in 8 mm-thick glass, two are fitted with lighting leds connected to a proper dimmer.

Vitrine composée d'une structure en verre cintré de 8 mm et porte avec serrure de 6 mm. Top en verre de 12 mm. Quatre étagères fixes en verre de 8 mm et supports-étagères en verre soudés à la structure; base en verre de 12 mm disponible en verre extralight dépoli verni dessous blanc ou en verre extralight argenté. Deux des quatre étagères sont équipés des leds d'éclairage branchés par un transformateur-variateur.

Struktur aus 8 mm-starkem gebogenem transparentem Glas. Tür mit Schloß aus 6 mm-starkem transparentem Glas. Deckel aus 12 mm starkem Glas. Glasfachbodenträger an die Struktur verschweißt. Vier feste Fachböden aus 8 mm-starkem Glas. Sockel, 12 mm Stärke, aus extralight, geätztem weiß- hinterlackiertem Glas oder aus extralight versilbertem Glas. Zwei der vier Glasfachböden sind mit Beleuchtungsled ausgerüstet. Trafo und Dimmer sind damit geliefert.

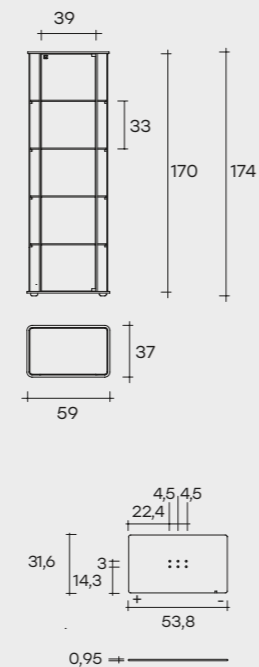

## milo sideboard

DESIGN  
ILARIA MARELLI



Vetrina contenitore in vetro curvato da 8 mm e ripiani da 10 mm, con particolari metallici in alluminio brillantato e acciaio inox; la vetrina contenitore è provvista di ante centrali in vetro diritto da 8 mm. Struttura in vetro curvato trasparente; ripiani e top trasparenti; base: vetro extralight retroargentato o laccato bianco, vetro trasparente retroverniciato nero. Struttura in vetro curvato fumè; ripiani e top fumè; base: vetro extralight retroargentato o in vetro trasparente retroverniciato nero.

160 x 45 x 80 cm  
63" x 17 11/16" x 31 1/2"

180 x 45 x 80 cm  
70 7/8" x 17 11/16" x 31 1/2"

200 x 45 x 80 cm  
78 3/4" x 17 11/16" x 31 1/2"

Showcase in 8 mm curved glass with 10 mm shelves, with brill aluminium and stainless steel metal fittings. The showcase has central doors in 8 mm straight glass. Transparent curved glass structure: transparent shelves and top; base: extralight glass back-silvered or white back-painted or transparent glass black back-painted Smoked grey curved glass structure: smoked grey shelves and top; base: extralight glass back-silvered or transparent glass black back-painted.

Vitrine rangement en verre cintré de 8 mm et étagères de 10 mm, avec éléments métalliques en aluminium brillanté et acier inoxydable; la vitrine rangement est dotée de battants centraux en verre droit de 8 mm. Structure en verre cintré transparent : étagères et top transparents ; base : verre extralight verni dessous blanc ou argenté, verre transparent verni dessous noir. Structure en verre cintré fumé : étagères et top fumé ; base : verre extralight argenté ou en verre transparent verni dessous noir.

Vitrine aus 8 mm starkem, gebogenem Glas, mit 10 mm starken Einlegeböden und Metallelementen aus geglänztem Aluminium und Edelstahl. Mittig platzierte Türen aus 8 mm starkem, geradem Glas. Korpus aus transparentem, gebogenem Glas: Einlegeböden und Deckplatte transparent, Basis: Glas Extralight versilbert oder weiß hinterlackiert, transparentes Glas schwarz hinterlackiert. Korpus aus gebogenem Rauchglas: Einlegeböden und Deckplatte aus Rauchglas; Basis: Glas Extralight versilbert oder transparent schwarz hinterlackiert.

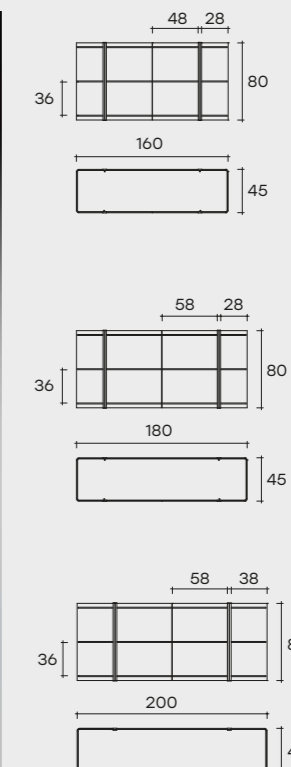

# palladio

DESIGN  
VITTORIO LIVI



Vetrina elettrificata in vetro curvato trasparente o extralight da 6 mm con quattro ripiani fissi in vetro da 6 mm e top in vetro da 12 mm. Base disponibile in legno noce canaletto, in vetro extralight da 12 mm acidato retroverniciato bianco o retro argentato o retroverniciato nero, Profili in alluminio finitura brill spazzolato. Anta con serratura. Corpo illuminante (optional) posizionabile anche sotto il top.

Wired showcase in 6 mm-thick curved transparent or extralight glass, with four 6 mm-thick glass shelves 12 mm thick glass top, door with lock. Base in wood walnut "canaletto", or in 12 mm thick extralight glass: backpainted black, back-silvered or acid-etched backpainted white Profiles in brushed aluminum glossy finish. The optional lights can also be placed under the top.

Vitrine électrifiée en verre transparent ou extralight cintré de 6 mm avec quatre étagères fixes en verre de 6 mm, top en verre de 12 mm, porte avec serrure. Base en bois noyer "canaletto". Base en verre extralight de 12 mm argenté, verni dessous noir ou dépoli verni dessous blanc Profils en aluminium brossé finition brillante. Les projecteurs peuvent être positionnés aussi sous le plateau.

Vitrine aus 6 mm-starkem gebogenem Glas, transparent oder extralight mit vier festen Fachböden aus 6 mm-starkem Glas. Ausgerüstet für eine Beleuchtung. Top aus 12 mm-starkem Glas. Basis aus Walnussholz, "Canaletto" oder Basis aus 12 mm starkem extralight Glas: Schwarz lackiert oder versilbert, geätzt Weiß lackiert Profile aus gebürstetem glänzendem Aluminium. Tür mit Schloss. Die optionale Beleuchtung kann auch unter das Top angebracht werden.

64 x 37 x 166 cm  
25 3/16" x 14 9/16" x 65 3/8"

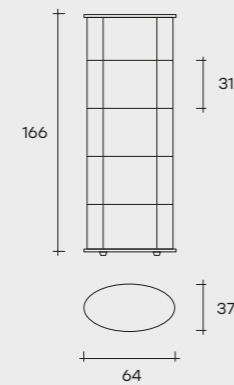

# palladio uno

DESIGN  
VITTORIO LIVI



Vetrina elettrificata in vetro curvato trasparente o extralight da 6 mm con tre ripiani fissi in vetro da 6 mm e top in vetro da 12 mm. Base disponibile in legno noce canaletto, in vetro extralight da 12 mm acidato retroverniciato bianco o retro argentato o retroverniciato nero, Profili in alluminio finitura brill spazzolato. Anta con serratura. Corpo illuminante (optional) posizionabile anche sotto il top.

Wired showcase in 6 mm-thick curved transparent or extralight glass, with three 6 mm-thick glass shelves 12 mm thick glass top, door with lock. Base in wood walnut "canaletto", or in 12 mm thick extralight glass: backpainted black, back-silvered or acid-etched backpainted white Profiles in brushed aluminum glossy finish. The optional lights can also be placed under the top.

Vitrine électrifiée en verre transparent ou extralight cintré de 6 mm avec trois étagères fixes en verre de 6 mm, top en verre de 12 mm, porte avec serrure. Base en bois noyer "canaletto". Base en verre extralight de 12 mm argenté, verni dessous noir ou dépoli verni dessous blanc Profils en aluminium brossé finition brillante. Les projecteurs peuvent être positionnés aussi sous le plateau.

Vitrine aus 6 mm-starkem gebogenem Glas, transparent oder extralight mit drei festen Fachböden aus 6 mm-starkem Glas. Ausgerüstet für eine Beleuchtung. Top aus 12 mm-starkem Glas. Basis aus Walnussholz, "Canaletto" oder Basis aus 12 mm starkem extralight Glas: Schwarz lackiert oder versilbert, geätzt Weiß lackiert Profile aus gebürstetem glänzendem Aluminium. Tür mit Schloss. Die optionale Beleuchtung kann auch unter das Top angebracht werden.

100 x 44 x 162 cm  
39 3/8" x 17 5/16" x 63 3/4"

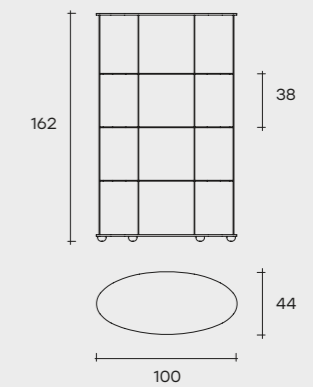

plié

DESIGN  
STUDIO KLASS

Madia composta da schienale in vetro Nero95 curvato da 8 mm, top in vetro fumè da 10 mm, ante in vetro extralight curvato da 6 mm parzialmente retroverniciate, 2 ripiani in vetro extralight da 8 mm di cui uno retroverniciato, base in legno laccato nero opaco, piedini, montanti e profili in metallo laccato nero opaco. Ante con meccanismo di apertura push-pull. Corpo illuminante a LED opzionale.

121 x 47 x 163 cm  
47 5/8" x 18 1/2" x 64 1/8"

Cupboard consisting of back in curved 8 mm Nero95 black glass, top in 10 mm smoked glass, doors in 6 mm curved extralight glass, partially back-painted, 2 shelves in 8 mm extralight glass, of which one back-painted, base in matt black laquered wood, feet, uprights and profiles in matt black lacquered metal. Doors with push-pull closing mechanism. Lighting with LEDs, as an option.

Buffet composé d'un panneau en verre noir (Nero95) cintré de 8 mm, top en verre fumé de 10 mm, porte en verre extralight cintré de 6 mm partiellement verni dessous, 2 étagères en verre extralight de 8 mm dont une vernis dessous, base en bois laqué noir opaque, pieds, montants et profils en métal laqué noir opaque. Portes avec mécanisme ouverture push-pull. Eclairage à LED en option.

Kasten mit Rückwand aus 8 mm Schwarzem (Nero95) Glas, Deckplatte aus 10 mm Rauchglas, Türen aus 6 mm gebogenem Extralight Glas mit Teilhinterlackierung, 2 Einlegeböden aus 8 mm Extralight Glas, von denen einer lackiert ist, Basiselement aus mattschwarz lackiertem Holz. Füßchen, Streben und Profile aus mattschwarz lackiertem Metall. Türen mit Push-Pull-Mechanismus. LED-Beleuchtung auf Wunsch.

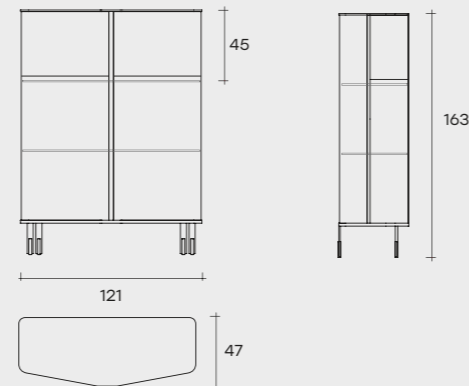

Vetro extralight retroverniciato "grigio polvere"  
"Powder grey"  
back-painted extralight glass



Vetro extralight retroverniciato "marrone-grey"  
"Brown-grey"  
back-painted extralight glass

varesina

DESIGN  
MATTEO NUNZIATI

Madia composta da elementi in vetro extralight o fumè curvato da 12 mm associati ad elementi contenitori chiusi, con ante a ribalta, in legno ricoperto da vetro "Skinglass" da 6 mm, smaltato a gran fuoco con finitura effetto tessuto, disponibile in tre varianti cromatiche: avorio, grafite o moka. Base in vetro extralight o fumè da 12 mm, piedini in vetro extralight o fumè da 15 mm.

Cupboard consisting of 12 mm extralight or smoked curved glass elements combined with closed container elements, with turnover doors, in wood covered with 6 mm "Skinglass", enamelled at high temperature with fabric-effect finish, available in three colours: ivory, graphite or moka. Base in 12 mm extralight or smoked glass, feet in 15 mm extralight or smoked glass.

Buffet composé d'éléments en verre extralight ou fumé cintré de 12 mm, associés à des éléments de rangement fermés, avec portes à bascule, en bois recouvert de verre "Skinglass" de 6 mm, émaillé à haute température avec finition effet tissu, disponibles dans trois versions chromatiques: ivoire, graphite, moka. Base en verre extralight ou fumé de 12 mm, pieds en verre extralight ou fumé de 15 mm.

Sideboard aus gebogenem 12 mm Extralight oder Rauchglas. Geschlossene Container-Elemente mit Klapptüren. Holzstruktur mit "Skinglass" Beschichtung, d.h. mit hohen Temperaturen behandelt Glas und Keramiksiebdruck um eine textile Optik und Haptik zu erhalten. Drei Variante: elfenbein-, graphitgrau- und mokabraun- Farbe. 12 mm extralight-Glas oder Rauchglasbasis, extralight-Glas oder Rauchglas Füßchen.

COMP. 240

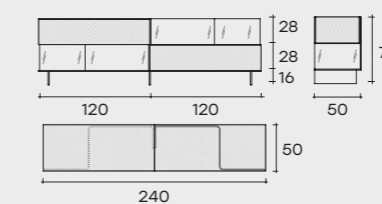

COMP. 240 BASIC

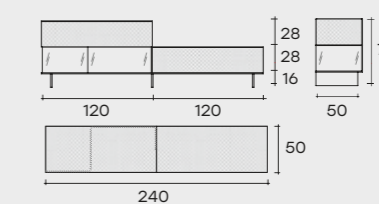

120 x 50 x 72 cm  
47 1/4" x 19 1/16" x 28 3/8"  
240 x 50 x 72 cm  
94 1/2" x 19 1/16" x 28 3/8"

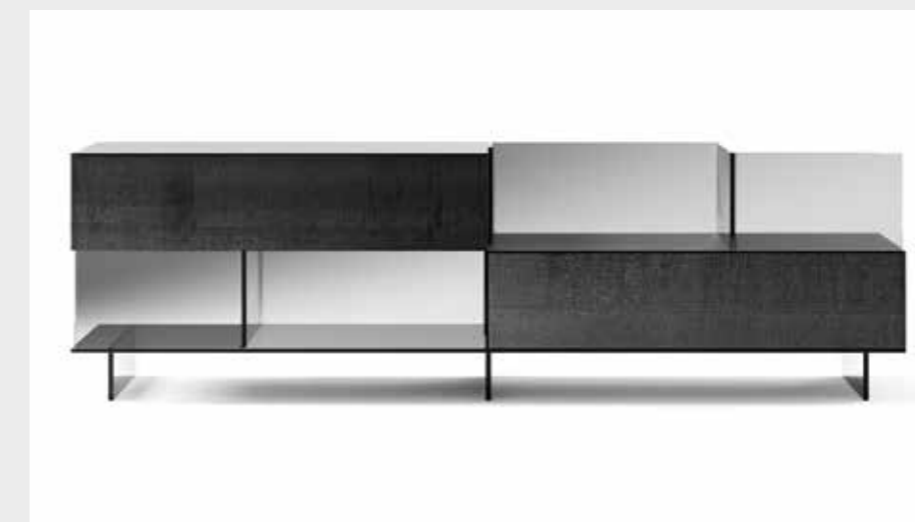

COMP. 120 - A

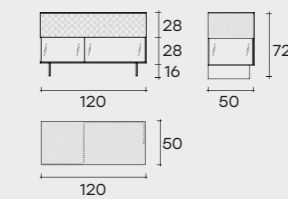

COMP. 120 - B

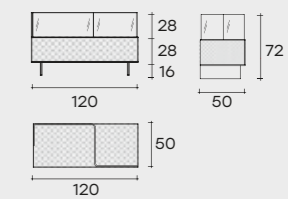

COMP. 120 - A CUSTOM

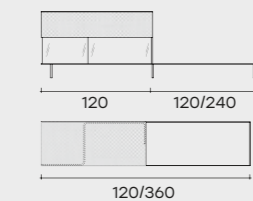

COMP. 120 - B CUSTOM

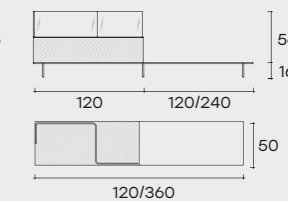

Vetro "Skinglass" Avorio  
"Skinglass" Ivory finish

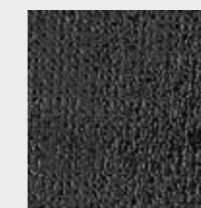

Vetro "Skinglass" Grafite  
"Skinglass" Graphite finish

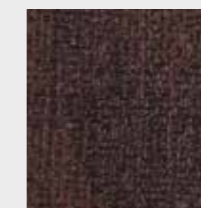

Vetro "Skinglass" Moka  
"Skinglass" Moka finish

# inori

DESIGN  
SETSU E SHINOBU ITO



Sistema composto da elementi in vetro o legno modulari. La modularità e versatilità ne permette l'utilizzo come libreria, espositore, contenitore, porta Tv.

System consisting of modular glass or wood elements. Its modularity and versatility allow it to be used as a bookcase, display case, storage unit or TV unit.

Système composé d'éléments modulaires en verre ou bois. Sa modularité et sa polyvalence permettent de l'utiliser comme une bibliothèque, un présentoir, un meuble de rangement, un meuble TV.

System aus modularen Glas-oder Holz-Elementen. Vielseitig einsetzbar und beliebig kombinierbar, als Bücherregal, Ausstellungsregal, TV-Element usw.

# inori freestanding

DESIGN  
SETSU E SHINOBU ITO



Il sistema Inori Freestanding si sviluppa in situazioni autoportanti: nelle versioni in vetro e nella misura larga 240 cm, da altezza minima 35 cm sino all'altezza massima 180 cm, il sistema prevede delle barre di irrigidimento in alluminio anodizzato nero.

The system Inori offers free-standing solutions: in glass versions and in width 240 cm, from a height of minimum 135 cm up to the maximum height of 180 cm, the system is complete with black anodised aluminium reinforcement bars.

Le système Inori se présente dans des solutions autoportantes: dans les versions en verre et dans la largeur de 240 cm, d'une hauteur minimale de 135 cm jusqu'à une hauteur maximale de 180 cm, le système est doté de barres d'armature en aluminium anodisé noir.

Das System Inori entwickelt sich als freistehender Raumteiler: in Glasausführung Breite 240 cm, Höhe mindestens 135 cm, maximal 180 cm, mit Verstärkungen aus Schwarz eloxiertem Aluminium.

240 x 36,5 x 180 cm  
94 1/2" x 14 3/8" x 70 7/8"

(H max 180 cm)  
Con accessorio dedicato  
With reinforcement bars



inori

DESIGN  
SETSU E SHINOBU ITO

Tutti i montanti sono liberamente posizionabili tramite sistema di ancoraggio e scorrimento a binario applicato su ogni singolo ripiano. Binario in alluminio anodizzato nero.

The uprights are freely adjustable on each shelf through sliding rails and fixing device. Slides in anodized black aluminum.

Tous montants sont positionnables avec un système de fixation et rail appliqué sur chaque étagère. Rail en aluminium anodisé noir.

Die Stützen sind frei verstellbar auf jedem Fachboden durch Führung und Befestigungsmodul. Laufschiene aus schwarzem eloxiertem Aluminium.



Ripiani in legno spessore 40 mm  
Wooden shelves 40 mm thick  
Étagères en bois, épaisseur 40 mm  
Holzfachböden, 40 mm Stärke

(L 180/240)



Ebano laccato lucido  
Glossy lacquered ebony  
Ebène laquée brillante  
Glänzlackiertes Ebenholz

Montanti in vetro curvato da 10 mm  
Uprights in curved glass, 10 mm thick  
Montants en verre cintré de 10 mm  
Stütze aus gebogenem Glas, 10 mm



Montanti: h 32 cm o h 42 cm  
Uprights: h 32 cm or h 42 cm  
Montants: h 32 cm ou h 42 cm  
Stütze: H 32 cm oder H 42 cm



Extralight \_ Extralight  
Extralight \_ Extralight



Trasparente \_ Transparent  
Transparent \_ Transparent



Nero95 \_ Black95  
Noir95 \_ Schwarz95

Base d'appoggio in vetro temperato, spessore 12 mm  
Base in tempered glass, 12 mm thick  
Base en verre trempé de 12 mm  
Basis aus gehärtetem 12 mm starkem Glas



Extralight retro-verniciato bianco  
Extralight white back-stained  
Extralight verni dessous blanc  
Extralight mit weißer Hinterlackierung

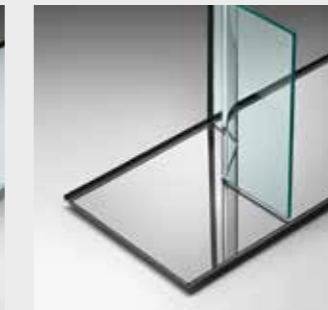

Extralight retro-argentato  
Extralight back-mirrored  
Extralight argenté dessous  
Extralight mit Hinterverspiegelung

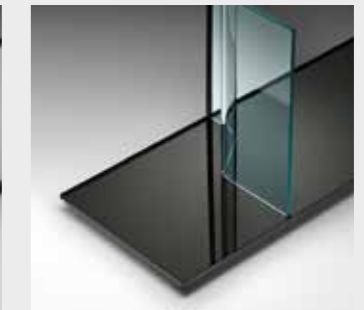

Fumé retro-verniciato nero  
Smoked glass black back-stained  
Fumé verni dessous noir  
Rauchglas mit schwarzer Hinterlackierung

Ripiani in vetro temperato, spessore 12 mm  
Shelves in tempered glass, 12 mm thick  
Étagères en verre trempé de 12 mm  
Fachböden aus gehärtetem 12 mm starkem Glas

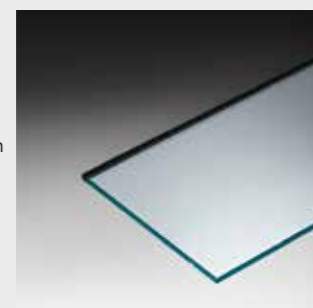

Extralight \_ Extralight  
Extralight \_ Extralight

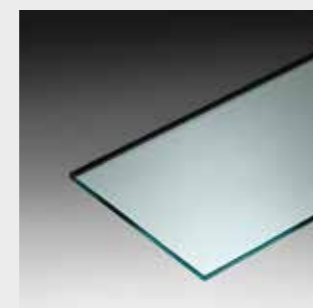

Trasparente \_ Transparent  
Transparent \_ Transparent

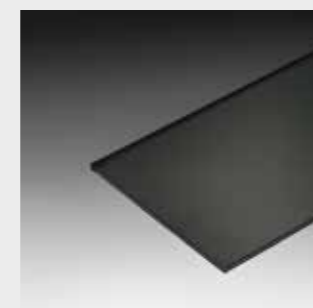

Fumé \_ Smoked  
Fumé \_ Rauchglas

Base d'appoggio in legno spessore 40 mm  
Wooden base, 40 mm thick  
Base en bois, épaisseur 40 mm  
Holzbasis, 40 mm Stärke

(L 180/240)

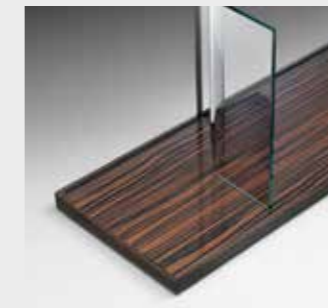

Ebano laccato lucido  
Glossy lacquered ebony  
Ebène laquée brillante  
Glänzlackiertes Ebenholz

inori

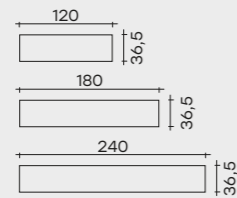
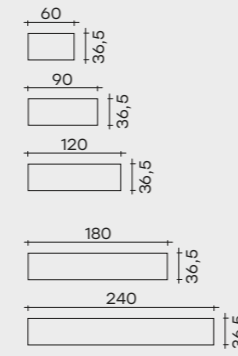
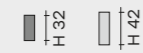
DESIGN  
SETSU E SHINOBU ITOBasi \_ Dimensioni  
Bases \_ Sizes  
Bases \_ Dimensions  
Basis \_ MaßeRipiani \_ Dimensioni  
Shelves \_ Sizes  
Étagères \_ Dimensions  
Fachböden \_ MaßeDisponibili solo  
nelle finiture vetro  
In glass versions only  
Pour les étagères  
en verre uniquement  
Für die Glasfachböden nurDisponibili in tutte  
le finiture  
In all finishings  
Pour toutes finitions  
Für alle FinishMontanti / Uprights  
Montants / StützeAlcuni suggerimenti tra le infinite soluzioni \_ Just a few of the numerous solutions  
Quelques suggestions parmi de nombreuses possibilités \_ Einige Vorschläge zu unzähligen Lösungen

## Libreria \_ Bookcase \_ Bibliothèque \_ Bücherregal

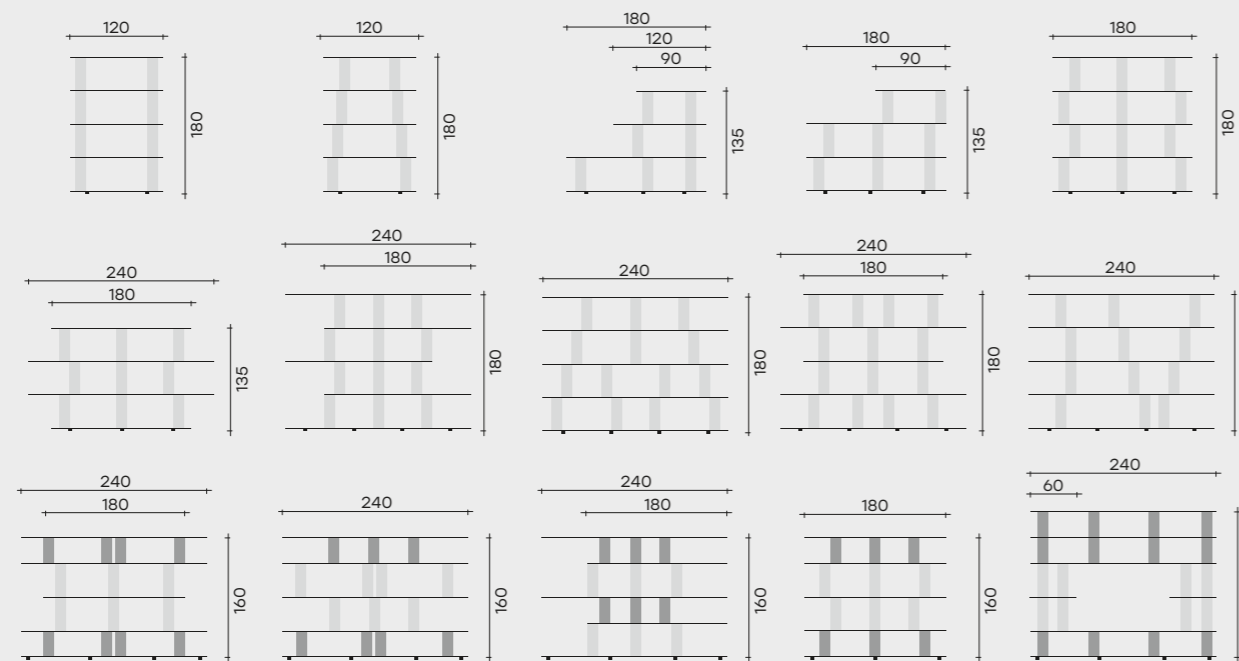
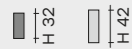
Montanti / Uprights  
Montants / Stütze

## Porta TV \_ Tv unit \_ Porte-TV \_ TV-Ständer

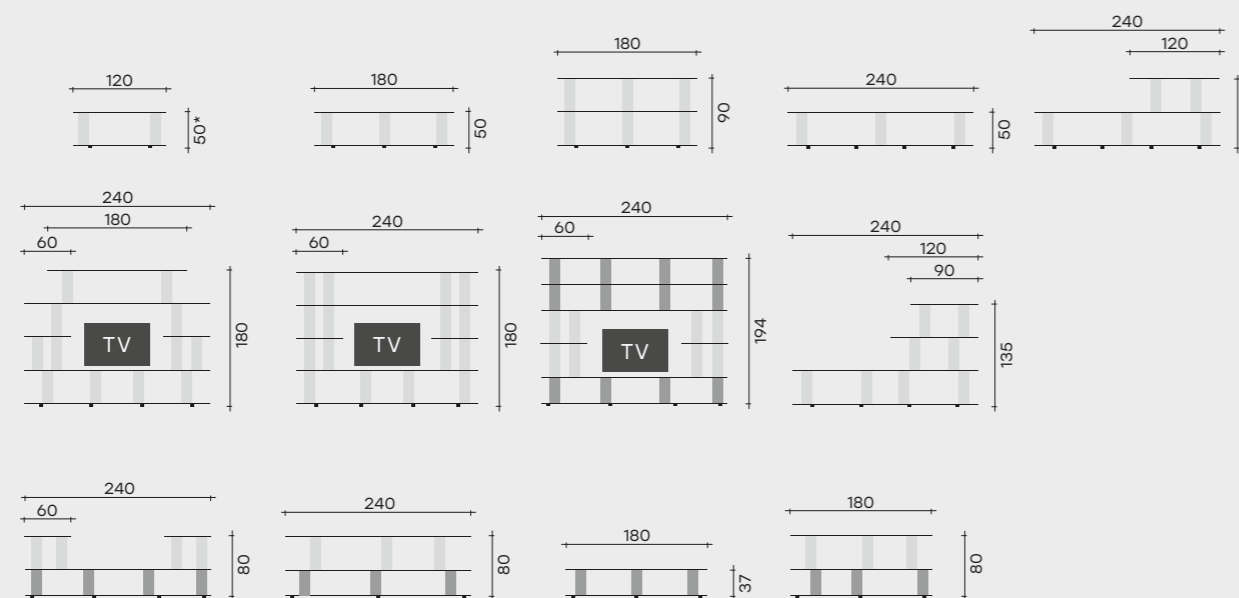
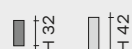
Montanti / Uprights  
Montants / Stütze

## Consolle \_ Console \_ Console \_ Konsole

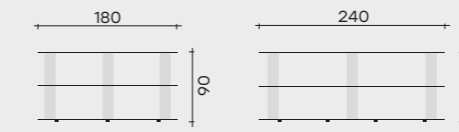
Montanti / Uprights  
Montants / Stütze

## Retro divano \_ Sofa back sideboard \_ Bout de Canape \_ Sofa Hinterelement

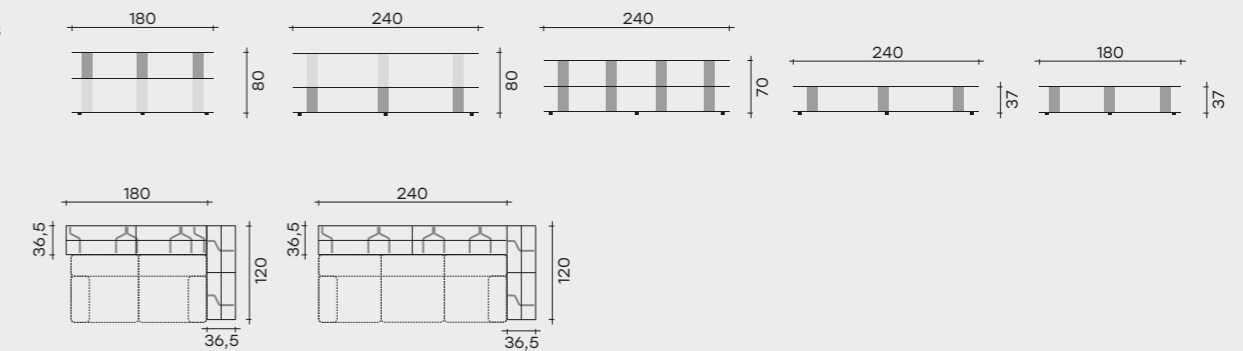
Montanti / Uprights  
Montants / Stütze

## Mobile basso \_ Low unit \_ Meubles bas \_ Kleinmöbel

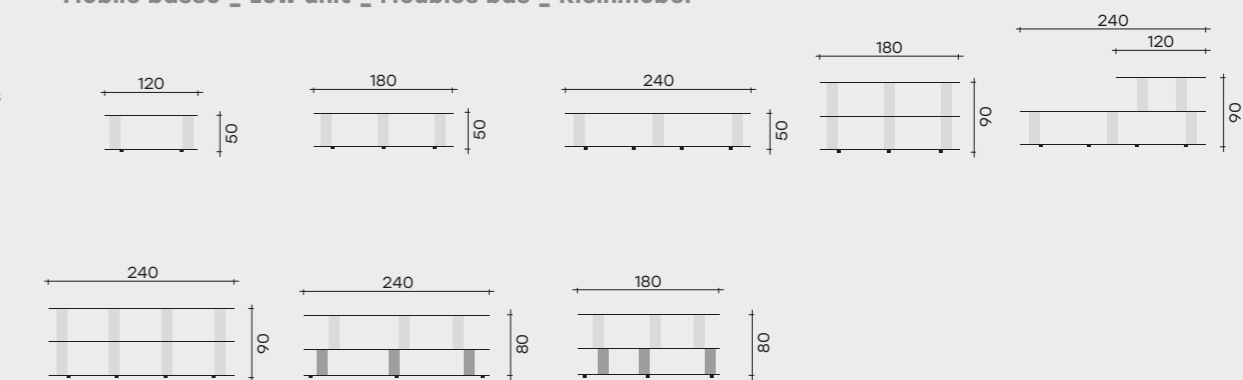
Montanti / Uprights  
Montants / Stütze

## Soluzione centrostanza \_ Room centrepiece solution \_ Solution en séparation de pièces \_ Zimmermitte-Lösung

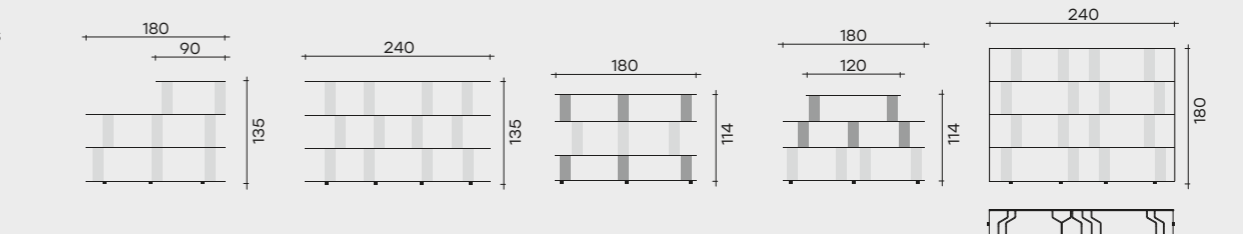
Montanti / Uprights  
Montants / Stütze

## Altezza massima per le strutture autoportanti:

- Su basi di lunghezza 240, solo versioni in vetro e con barre di irrigidimento: h max 180 cm.
- Su basi di lunghezza 180 / 240 cm senza barre di irrigidimento: h max 135 cm.
- Su basi di lunghezza 120 cm senza barre di irrigidimento: h max 50 cm.

## Altezza massima per le strutture con ancoraggio a muro:

- massimo 5 ripiani ed altezza totale massima 234 cm. (equivalente a 3 montanti h 32 cm abbinati a 2 montanti h 42)

## Distanza massima tra i montanti: 130 cm.

## Max. height of the free-standing version:

- Glass versions width 240 cm with reinforcement bars: maximum height 180 cm.
- With base length 180 / 240 cm without reinforcement bars: h max 135 cm.
- With base length 120 cm without reinforcement bars: h max 50 cm.

## Max. height of the wall version:

- max. 5 shelves - total height 234 cm. (i.e. 3 uprights in height 32 cm and 2 uprights height 42 cm)

## Max. distance between the uprights: 130 cm.

## Hauteur maxi. pour les structures posées au sol:

- Avec base de longueur 240 cm dans les versions en verre et avec barres d'armature: h max 180 cm.
- Avec base de longueur 180 / 240 cm sans barres d'armature: h max 135 cm.
- Avec base de longueur 120 cm sans barres d'armature: h max 50 cm.

## Hauteur maxi. pour les structures accrochables au mur:

- Avec max.5 étagères - hauteur totale 234 cm. (c.à.d. 3 montants hauteur 32 cm et 2 montants hauteur 42 cm)

## Distance maxi entre les montants: 130 cm.

## Max. Höhe der Standausführung:

- Mit Basislänge 240 cm Glasversion mit Verstärkungen: H max 180 cm.
- Mit Basislänge 180 / 240 cm ohne Verstärkungen: H max 135 cm.
- Mit Basislänge 120 cm ohne Verstärkungen: H max 50 cm.

## Max.Höhe der Wandausführung:

- Mit max. 5 Fachböden - Gesamthöhe 234 cm (gleich mit 3 Stützen 32 cm hoch und 2 Stützen 42 cm hoch)

## Max. Abstand zwischen den Stützen: 130 cm.

# babila

DESIGN  
LUCA CASINI



Mensole in vetro curvato da 10 mm. Disponibili anche in vetro extralight. Reggimensola in metallo cromato.

Shelves in 10 mm-thick curved glass. Also available in extralight glass. Brackets in chromed metal.

Étagères en verre cintré de 10 mm. Disponible aussi en verre extralight. Support étagère en métal chromé.

Konsole aus 10 mm-starkem gebogenem Glas. Lieferbar auch aus extralight-Glas. Fachbodenträger aus verchromtem Metall.

100 x 27 x 18,5 cm  
39 3/8" x 10 5/8" x 7 5/16"

100 x 27 x 36 cm  
39 3/8" x 10 5/8" x 14 3/16"

100 x 27 x 37 cm  
39 3/8" x 10 5/8" x 14 9/16"

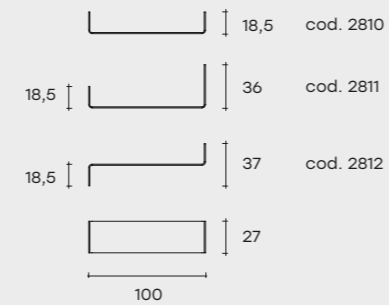

Possibili posizioni  
Possible positions  
Positions possible  
Mögliche Stellungen

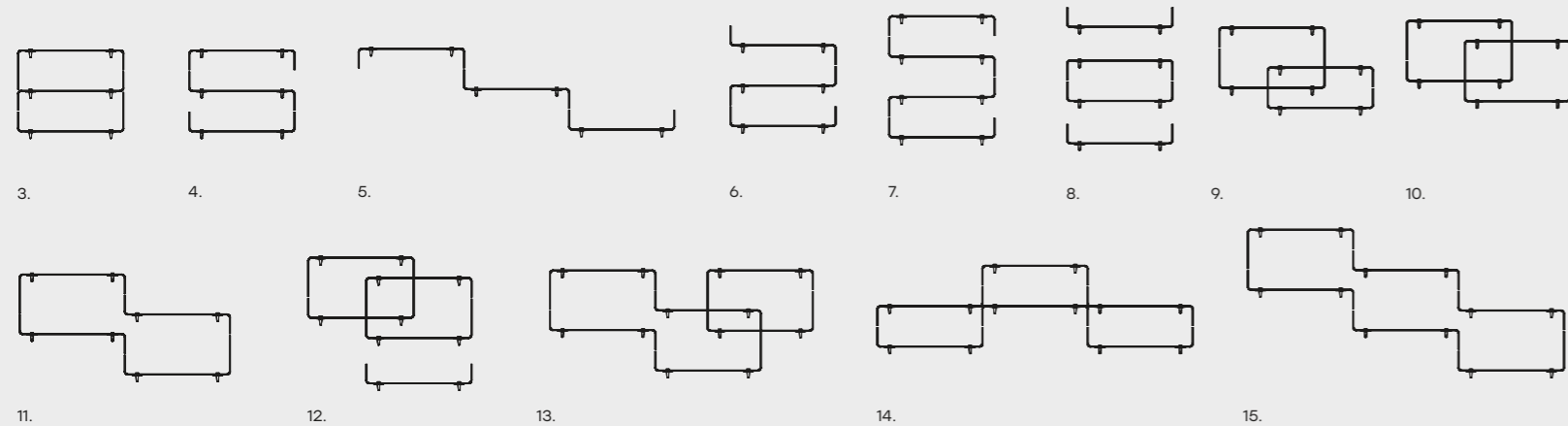
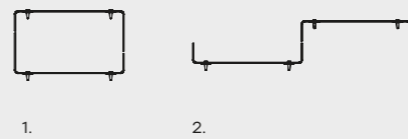

# foulard

DESIGN  
STUDIO KLASS



Mensola in vetro trasparente curvato da 10 mm. Reggimensola in metallo cromato.

Shelf in curved 10 mm transparent glass. Chromed metal bracket.

Etagère en verre transparent cintré de 10 mm. Support d'étagère en métal chromé.

10 mm starke Konsole aus gebogenem, transparentem Glas. Halterung aus verchromtem Metall.

35 x 32 x 35 cm  
13 3/4" x 12 5/8" x 13 3/4"

70 x 32 x 35 cm  
27 9/16" x 12 5/8" x 13 3/4"

105 x 32 x 25 cm  
41 5/16" x 12 5/8" x 9 13/16"

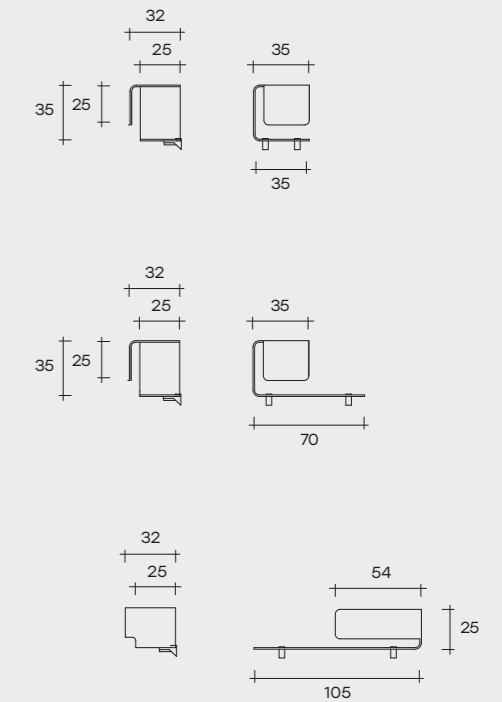



# mensole

DESIGN  
GERUSSI - SARTORIS



Mensole in vetro curvato da 10 mm. Disponibili anche in vetro extralight. Reggimensola in metallo verniciato nero lucido o alluminio satinato.

Shelves in 10 mm-thick curved glass. Also available in extralight glass. Metal bracket, glossy black or aluminium lacquered.

Étagères en verre cintré de 10 mm. Disponible aussi en verre extralight. Support étagère en métal verni noir brillant ou aluminium.

Konsole aus 10 mm-starkem gebogenem Glas. Lieferbar auch aus extralight-Glas. Fachbodenträger aus Metall hochglanz schwarz- oder Aluminium-lackiert.

90 x 27 x 35 cm  
35 7/16" x 10 5/8" x 13 3/4"

120 x 27 x 35 cm  
47 1/4" x 10 5/8" x 13 3/4"

90 x 27 x 70 cm  
35 7/16" x 10 5/8" x 27 9/16"

120 x 27 x 70 cm  
47 1/4" x 10 5/8" x 27 9/16"

# mensole rialto L

DESIGN  
CRS FIAM



Mensole in vetro curvato da 10 mm. Reggimensola in metallo cromato. Le mensole sono disponibili anche su misura con i seguenti limiti: lunghezza: da 65 cm a 190 cm; profondità: da 24 cm a 30 cm; altezza: fino a 36 cm per lunghezze entro i 100 cm e fino a 70 cm per lunghezze oltre i 100 cm. L'interasse massimo tra i reggimensola è di 70 cm.

Shelves in 10 mm curved glass. Chromed metal brackets. The shelves are also available custom-sized with the following limits: length: from 65 cm to 190 cm; depth: from 24 cm to 30 cm; height: up to 36 cm for lengths up to 100 cm and up to 70 cm for lengths over 100 cm. The maximum gap between brackets is 70 cm.

Étagères en verre cintré de 10 mm. Supports d'étagère en métal chromé. Les étagères sont également disponibles sur mesure avec les limites suivantes : longueur : de 65 cm à 190 cm, profondeur : de 24 cm à 30 cm, hauteur : jusqu'à 36 cm pour les longueurs inférieures à 100 cm et jusqu'à 70 cm pour les longueurs supérieures à 100 cm. La distance maximale entre les supports d'étagère est de 70 cm.

Konsole aus 10 mm starkem, gebogenem Glas. Konsolehalterungen aus verchromtem Metall. Auch maßgefertigt lieferbar in Längen von 65 bis 190 cm, Tiefen von 24 bis 30 cm, Höhen bis 36 cm für Längen bis 100 cm, Höhen bis 70 cm für Längen über 100 cm. Maximaler Mittenabstand zwischen den Halterungen 70 cm.

190 x 30 x 40 cm  
74 13/16" x 11 13/16" x 15 3/4"

140 x 24 x 40 cm  
55 1/8" x 9 7/16" x 15 3/4"

100 x 24 x 36 cm  
39 3/8" x 9 7/16" x 14 3/16"

65 x 24 x 30 cm  
25 9/16" x 9 7/16" x 11 13/16"

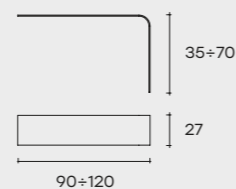

Possibili posizioni  
Possible positions  
Positions possibles  
Mögliche Stellungen

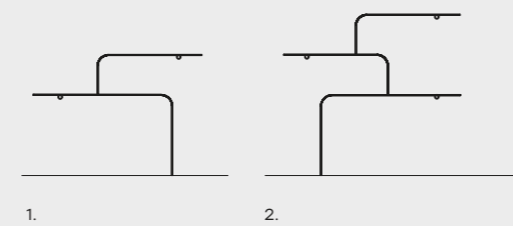

1. 2.

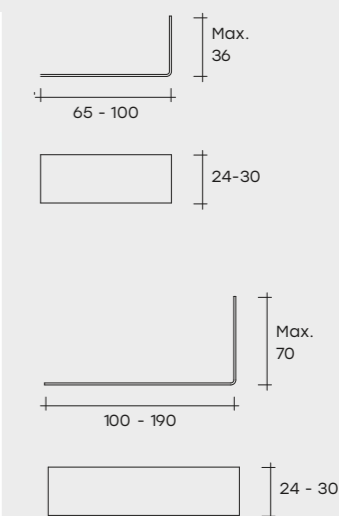

Possibili composizioni  
Possible compositions  
Compositions possibles  
Mögliche Zusammensetzungen

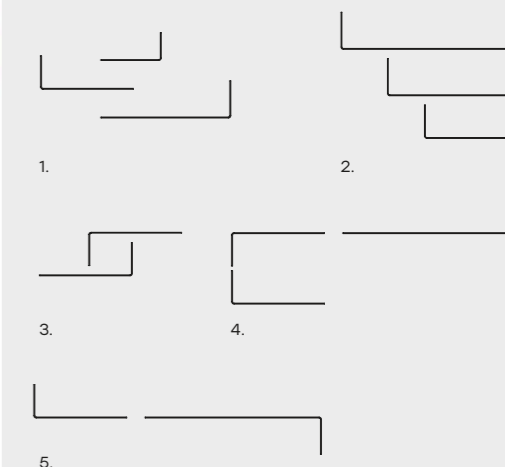

1. 2.  
3. 4.  
5.

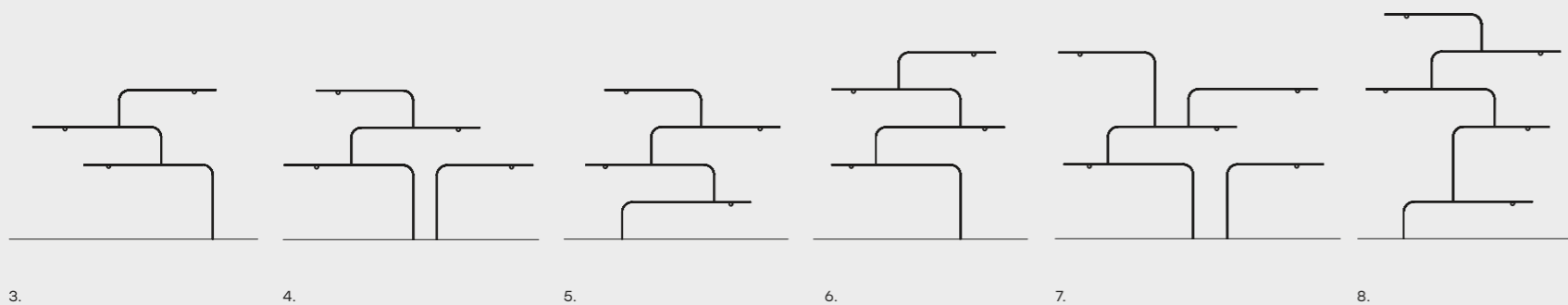

3. 4. 5. 6. 7. 8.

# cobra

DESIGN  
ELIO VIGNA

Portaombrelli in vetro  
curvato da 10 mm  
con basamento  
in metallo verniciato nero.

Umbrella stand  
in 10 mm-thick  
curved glass  
with black metal base.

Porte-parapluies  
en verre cintré  
de 10 mm avec base  
en métal verni noir.

Schirmständer aus  
10 mm-starkem  
gebogenem Glas  
mit schwarz-lackierter  
Metallbasis.

35 x 35 x 67 cm  
13 3/4" x 13 3/4" x 26 3/8"

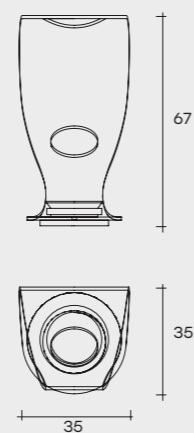

# elix

DESIGN  
FABIO DI BARTOLOMEI

Appendiabito in vetro  
curvato da 15 mm  
con base a calotta  
sferica, rivestito in ABS  
nero goffrato,  
accessori color nero.

Coat-hanger in 15 mm-thick  
curved glass, casted  
to a spherical cap base,  
in black coated ABS,  
black lacquered accessories.

Porte-manteaux  
en verre cintré de 15 mm  
ancré à un piétement  
à calotte sphérique revêtu  
en ABS couleur noire mate.  
Accessoires noirs.

Gardenrobeständer  
aus 15 mm-starkem  
gebogenem Glas.  
Kugelhappenförmiger  
Basis mit ABS-Kunststoff  
beschichtet, schwarz geprägt.

Ø 37 x 187 cm  
Ø 14 9/16" x 73 5/8"

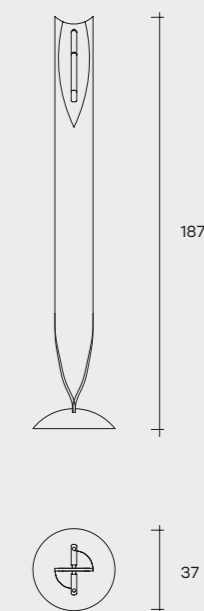
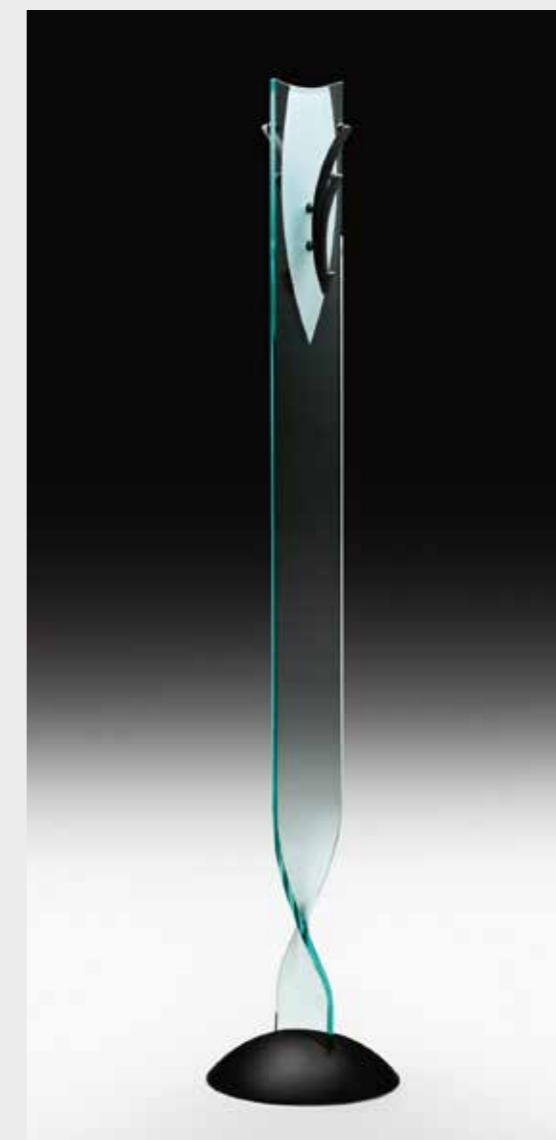

# homo sapiens

DESIGN  
FABIO DI BARTOLOMEI

Servo muto in vetro curvato da 12 mm, con base a calotta sferica rivestito in ABS nero goffrato. Bicchiere porta-oggetti verniciato nero opaco.

Valet in 12 mm-thick curved glass casted to a spherical cap base, in black coated ABS. Object-holder matt black lacquered.

Valet en verre cintré de 12 mm ancré à un piétement à calotte sphérique revêtu en ABS couleur noire gaufrée. Porte-objets verni noir mat.

Kleiderständer aus 12 mm-starkem gebogenem Glas. Kugelkappenförmiger Basis mit ABS-Kunststoff beschichtet, schwarz geprägt. Ablageschälchen aus schwarz-lackiertem Holz.

47 x 37 x 129 cm  
18 1/2" x 14 9/16" x 50 3/4"

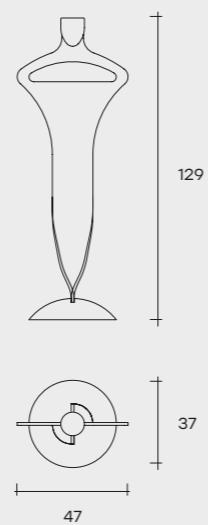

# l'astra

DESIGN  
LO BIANCO-MANSUETO

Lampada da tavolo in vetro curvato da 8 mm. Portalampana in alluminio brill.

Table lamp in 8 mm curved glass. Polished aluminium lamp holder.

Lampe de table en verre cintré de 8 mm. Douille en aluminium brillant.

Tischleuchte aus 8 mm starkem gebogenem Glas. Lampenfassung aus geglänztem Aluminium.

26 x 29 x 46 cm  
10 1/4" x 11 7/16" x 18 1/8"

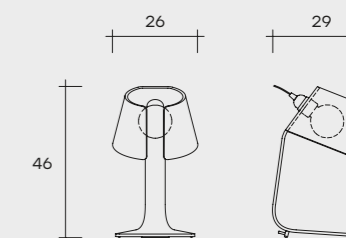

loy-k

DESIGN  
CHAFIK GASMI

Lampada da terra girevole  
in vetro fuso a gran fuoco  
da 8 mm. Telaio  
in metallo verniciato nero.  
Illuminazione diffusa  
tramite impianto a LED.

Revolving free-standing  
lamp in 8 mm  
high-temperature  
fused glass.  
Black painted metal  
frame. Diffused lighting  
with LED system.

Lampe au sol pivotante  
en verre en fusion  
au grand feu de 8 mm.  
Cadre en métal peint noir.  
Éclairage par système  
de LED.

Drehbare Stehlampe  
aus 8 mm starkem,  
bei höher Temperatur  
geschmolzenem Glas.  
Rahmen aus schwarz-  
lackiertem Metall.  
Beleuchtung  
mit LED-Anlage.

38 x 37 x 190 cm  
15" x 14 9/16" x 74 13/16"

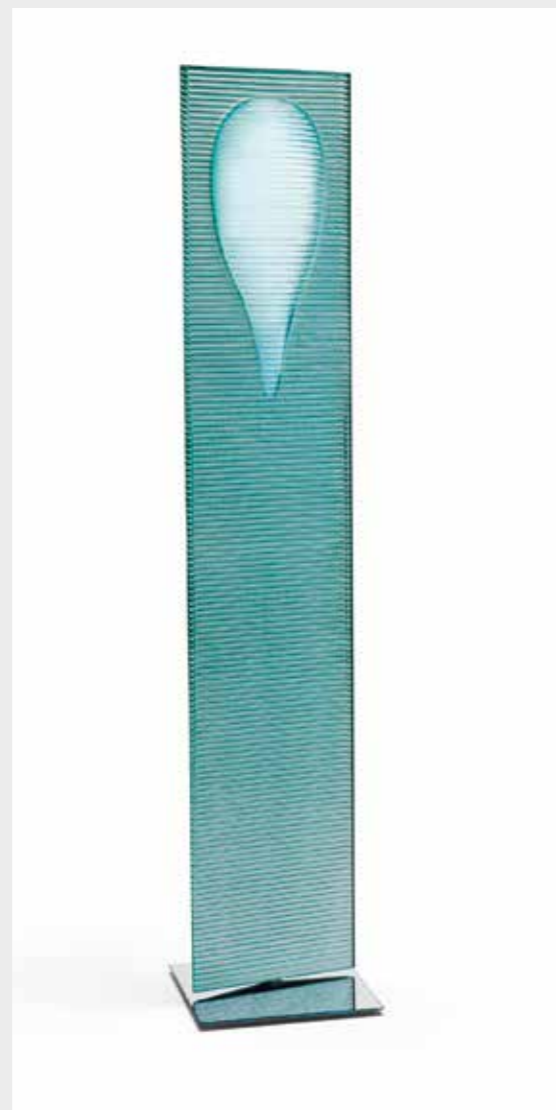
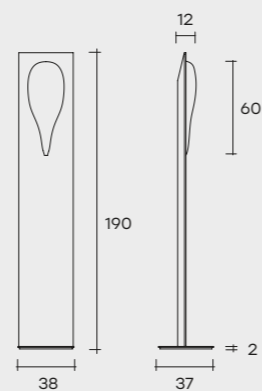

mir lampada

DESIGN  
ROBERTO PAOLI

Specchio-lampada da terra  
girevole con scocca  
in vetro curvato a gran  
fuoco argentato da 6 mm.  
Telaio interno in acciaio  
verniciato, base a specchio  
da 8 mm saldata  
su piatto in acciaio  
verniciato. Provvisto  
di kit illuminazione interna.

Revolving mirror-standing  
lamp with 6 mm high  
temperature curved  
silvered glass frame.  
Inside supporting mount  
in painted steel, base  
composed of a 8 mm  
thick mirror jointed to  
a lacquered steel plate.  
Lighting kit inside.

Miroir-lampadaire pivotant  
avec coque en verre cintré  
en fusion argenté de 6 mm.  
Cadre interne en acier  
verni, base en miroir de  
8 mm soudée sur plat en  
acier. Kit éclairage interne.

Drehbares Spiegel-  
Stehlampelement  
mit bei sehr hohen  
Temperaturen versilberter,  
6 mm starker gebogener  
Glas. Spiegel Basis, 8 mm  
stark, verschweißt  
auf einem Stahlplatte.  
Integrierter Beleuchtung.

Ø 53 x 198 cm  
Ø 20 7/8" x 77 15/16"

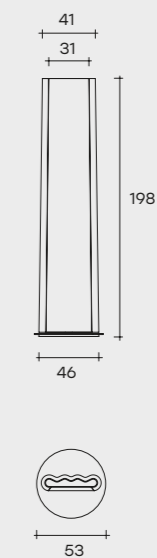

# vogue

DESIGN  
ROBERTO PAOLI

Portariviste in vetro  
trasparente curvato  
da 10 mm con appoggi  
in acciaio inox.

Magazine rack  
in 10 mm curved  
transparent glass  
with steel stand.

Porte-revues en verre  
transparent cintré  
de 10 mm avec supports  
en acier inoxydable.

Zeitungsständer  
aus 10 mm starkem,  
gebogenem, transparentem  
Glas mit Edelstahl  
Untergestell.

40 x 12 x 30 cm  
15 3/4" x 4 3/4" x 11 3/4"

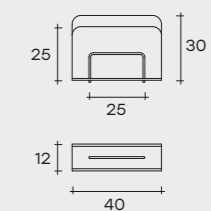

# materiali materials

## vetro trasparente transparent glass



**V1**  
Vetro trasparente  
Transparent glass



**V2**  
Vetro trasparente acidato  
Etched glass



**V4**  
Vetro trasparente  
retroverniciato nero  
Black back-painted glass

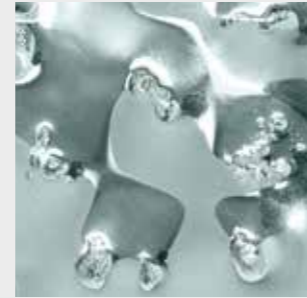

**V5**  
Vetro trasparente  
fuso argentato  
Back-silvered fused glass

## vetro extralight extralight glass

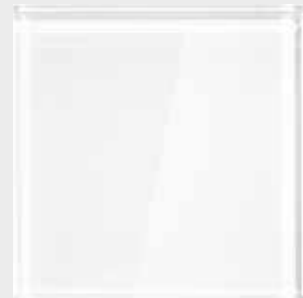

**VX1**  
Vetro extralight  
Extralight glass

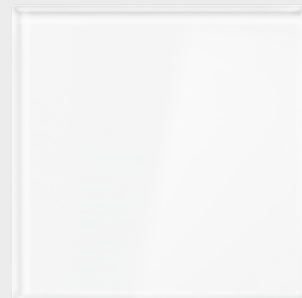

**VX2**  
Vetro extralight acidato  
Etched extralight glass

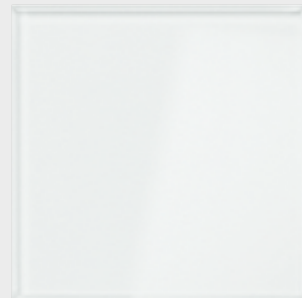

**VX3**  
Vetro extralight acidato  
retroverniciato bianco  
White back-painted and  
etched extralight glass



**VX4**  
Vetro extralight  
retroverniciato bianco  
White back-painted  
extralight glass



**VX7**  
Vetro extralight retroverniciato  
"marrone-grey"  
"Brown-grey" back-painted  
extralight glass



**VX8**  
Vetro extralight  
retroverniciato "grigio polvere"  
"Powder grey"  
back-painted extralight glass

## altri vetri other glasses



**AV1**  
Vetro fumé  
Smoked glass



**AV2**  
Vetro bronzo  
Bronze glass



**AV3**  
Vetro nero 95  
Black 95 glass



**AV5**  
Vetro titanium  
Titanium glass

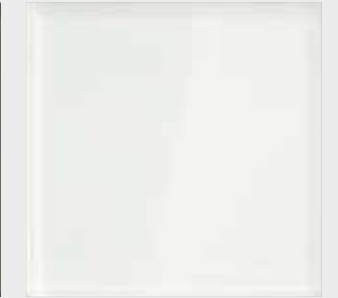

**AV6**  
Vetro bianco opale  
Opal glass



**AV8**  
Vetro fumé retroargentato  
Back-silvered smoked glass

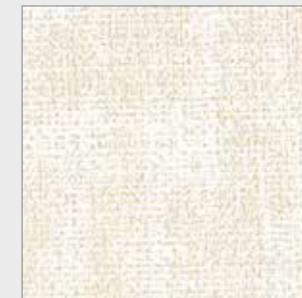

**AV11**  
Vetro "Skinglass" Avorio  
"Skinglass" Ivory finish

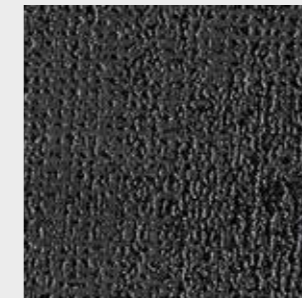

**AV12**  
Vetro "Skinglass" Grafite  
"Skinglass" Graphite finish



**AV13**  
Vetro "Skinglass" Moka  
"Skinglass" Moka finish

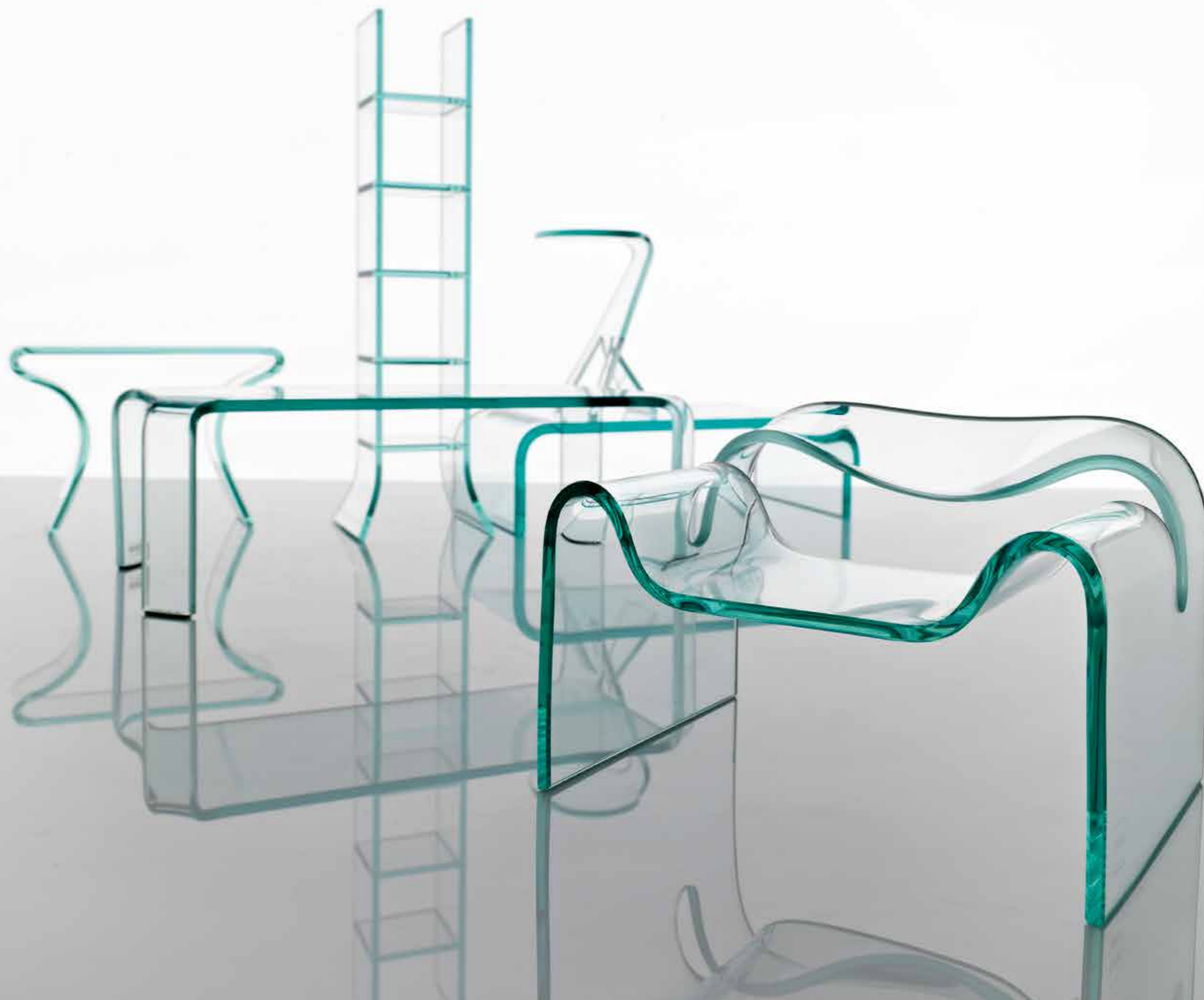

mini collection

# mini collection



È noto che FIAM Italia, nella lavorazione del vetro curvato, può definirsi unica al mondo. Le sue creazioni rappresentano ormai storici "capolavori", originali per concezione progettuale, inimitabili per rigore stilistico e impeccabile esecuzione. L'idea di realizzare "miniature" dei prodotti storici FIAM Italia nasce nel 2000. L'intento è quello di proporre una

collezione di opere in scala ridotta che testimoniano l'unicità del cristallo curvato oltre a dimostrare allo stesso tempo come tali opere, assunta una nuova veste e una nuova dimensione, possano continuare ad offrire un'alta carica espressiva capace di aggiungere bellezza, poesia ed un tocco di vita in più alle nostre case.

On sait que FIAM Italia, dans le travail du verre cintré, peut se considérer comme étant unique au monde. Ses créations sont des « chefs-d'oeuvre » historiques, dont la conception de projet est originale, et la rigueur stylistique et l'exécution impeccable inimitables. L'idée de réaliser des « miniatures » des produits historiques FIAM Italia est née en l'an 2000. L'intention était de proposer une collection de pièces à l'échelle réduite exprimant le caractère unique du cristal cintré et de démontrer que ces pièces, habillées d'une nouvelle présentation et d'une nouvelle dimension, pouvaient continuer à dégager une charge expressive en mesure d'ajouter de la beauté, de la poésie et une touche de vie à votre intérieur.

FIAM Italia's world-wide unique status in the processing of curved glass is universally acknowledged. Its creations have become historic masterpieces, original in their design concept, inimitable in their exquisite styling and impeccable craftsmanship. The idea of producing miniatures of FIAM Italia's most famous products dates from 2000. The aim was to offer a collection of works on a small scale that would illustrate the unique features of curved plate glass as well as proving that, even in a new form and size, these works still have a striking expressive charge, capable of adding beauty, poetry and a touch of extra life to our homes.

FIAM Italia ist auf der ganzen Welt für seine einzigartigen Produkte aus gebogenem Glas bekannt. Viele Kreationen von FIAM Italia gelten auf Grund ihres außergewöhnlichen Konzepts, ihres unnachahmbaren Stils und ihrer exzellenten Ausführung als wahre Meisterwerke des internationalen Designs. Die Idee, Miniaturmodelle dieser in die Geschichte des Designs eingegangenen Meisterwerke herzustellen, wurde bereits im Jahr 2000 geboren, mit der Absicht, eine Kollektion von maßstabgetreuen Modellen zu schaffen, die Zeugnis von der Einzigartigkeit des gebogenen Kristall-glases ablegen und gleichzeitig unter Beweis stellen, dass diese Meisterwerke auch in einer neuen Aufmachung und im Miniaturformat ihre ganze Ausdruckskraft beibehalten und unser Zuhause mit Schönheit, Poesie und einem Hauch von Leben bereichern.

## ADMIRAL



H 27 cm  
ø 6 cm

## BABELE



H 34 cm  
L/W/L 9 cm  
P/D/T 9 cm

## MANTA



H 7 cm  
L/W/L 23 cm  
P/D/T 14 cm

## CHARLOTTE



H 11 cm  
L/W/L 17 cm  
P/D/T 5,5 cm

## COBRA



H 14 cm  
L/W/L 7 cm  
P/D/T 8,5 cm

## GHOST



H 11 cm  
L/W/L 17,5 cm  
P/D/T 15,5 cm

## GRILLO



H 12 cm  
L/W/L 10,5 cm  
P/D/T 8 cm

## ALVAR AALTO



H 10,5 cm  
ø 9 cm

## PONTE



H 8 cm  
L/W/L 26 cm  
P/D/T 14 cm

## RAGNO



H 10,5 cm  
L/W/L 30,5 cm  
P/D/T 16 cm





## FIAM, garanzia di qualità

FIAM è certificata UNI EN ISO 9001:2008; la conformità a questa norma di riferimento permette a FIAM di raggiungere altissimi standard qualitativi. Una delle testimonianze dirette è la rintracciabilità dei suoi manufatti: ogni prodotto FIAM reca una decalcomania indelebile, cotta ad altissima temperatura, nella quale viene riportato oltre al marchio aziendale, un codice che permette di ricostruire il suo intero ciclo produttivo.

## FIAM, garantie de qualité

FIAM est une entreprise certifiée UNI EN ISO 9001:2008; la conformité à cette norme de référence permet à FIAM d'atteindre des niveaux de qualité très élevés. La traçabilité des produits en est une preuve: chaque produit FIAM porte une décalcomanie indélébile, cuite à très haute température, qui mentionne la marque de l'entreprise et un code permettant de reconstruire tout son cycle de production.

## FIAM, garantee of quality

Fiam is certified UNI EN ISO 9001:2008; the conformity to this reference norm allows Fiam to reach the highest quality standards. One of the direct evidences is the possibility to track of the products: a high temperature and therefore indelible decal is applied to every article, in addition to the company logo, this decal also bears a number of codes that allow the production cycle details of the article to be traced.

## FIAM, eine Qualitätsgarantie

FIAM ist nach UNI EN ISO 9001:2008 zertifiziert und garantiert damit für höchste Qualitätsstandards. Dazu gehört auch die Nachverfolgbarkeit des Entstehungsweges der Erzeugnisse: Jedes FIAM-Produkt wird mit einem bei hohen Temperaturen eingebrannten Abziehbild versehen, auf dem neben dem Markenzeichen des Herstellers eine Identifikationsnummer steht, anhand der sich der gesamte Produktionszyklus des Artikels nachverfolgen lässt.

## La garanzia del risultato: il controllo qualità.

Guaranteed flawless standards: quality control.  
La garantie du résultat: le contrôle qualité.  
Die Garantie für das Resultat – die Qualitätskontrolle.



**art direction****copywriting**  
acanto comunicazione  
(carlo piazzesi)**graphic design and layout**  
acanto comunicazione**rendering images**  
acanto comunicazione**photography and postproduction**  
studio amatibacciardi  
studio leon**styling**  
monti studio  
candida zanelli and serenella parri**coordination and logistics**  
daniele livi**selections**  
olimpia visual plan**print and packaging**  
grapho 5**credits**

ALESSI  
ALFRED DRAGO RENS - GALLERIA L'AFFICHE  
AMINI CARPETS  
APPLE  
ARTEK  
AXIL  
SILVANO BACCIARDI  
BAXTER  
BOFFI  
BPA INTERNATIONAL  
BUSNELLI di Gruppo Industriale Busnelli  
CAPPELLINI  
CECILIA MARINO  
CINOVA di Gruppo Industriale Busnelli  
COHEN SEDGH TAPPETI  
D3CO  
DEDAR  
DE PADOVA  
DESALTO  
EDD  
ENTRATA LIBERA  
FINN FORM PER ITTALA  
FLOS  
FLOU  
GALLERIA ARTRA MILANO  
GOLRAN  
INCIPITLAB  
JAB  
LIVING DIVANI  
DAVIDE LOVATTI  
LUCEPLAN  
MARTA FULVI  
MARTINELLI LUCE  
MOROSO  
NANIMARQUINA  
O LUCE  
ORIZZONTI  
PIANCA E OTTOEMEZZO  
POLIFORM  
RAW  
RATTI BOUTIQUE  
RINA MENARDI  
ROMAGNOLI ARREDAMENTI PESARO  
ROSENTHAL  
SAMBONET  
SANTAECOLE  
SILVA TESSUTI  
SONY ITALIA  
VERY WOOD  
VITRA

Fiam Italia  
Via Ancona 1/b  
61010 Tavullia (PU), Italia  
Tel. 0039 0721 20051  
Fax: 0039 0721 202432

[www.fiamitalia.it](http://www.fiamitalia.it)  
[info@fiamitalia.it](mailto:info@fiamitalia.it)



fiamitalia.it

 [www.facebook.com/fiamitalia](https://www.facebook.com/fiamitalia)