

3	HOME OFFICE: quando passione e lavoro sono di casa HOME OFFICE: when passion and craftsmanship feel at home	4
	FIAM, Cultura del vetro FIAM, the art of glass	6
	Designer e riconoscimenti Designers and awards	8
	Ecosostenibilità Ecosustainable	12
	Poltrona Ghost Ghost armchair	14
	Indice generale prodotti General product index	2
	HOME OFFICE	
Scrivanie Desks	16	
Tavoli riunioni Meeting tables	60	
Librerie, mensole, cassettiere Bookshelves, shelves, Drawer Units	70	
Schede tecniche Technical data sheets	84	
CUSTOM MADE & CONTRACT	110	
Materiali Materials	152	
Mini collection Mini collection	156	
Garanzia di qualità e certificazioni Garantee of quality and certifications	158	

1	SPECCHI MIRRORS
	SPECCHI TV MIRRORS-TV
	ESPOSITORI, VETRINE, CONTENITORI SHOWCASES, DISPLAY UNITS, CONTAINER CABINETS
	LIBRERIE, SISTEMI BOOKSHELVES, SYSTEMS
	MENSOLE SHELVES
	ACCESSORI ACCESSORIES

2	TAVOLI TABLES
	TAVOLI BASSI E DI SERVIZIO COFFEE TABLES AND SIDE TABLES
	COMODINI BEDSIDE TABLES
	CONSOLLE CONSOLES
	SEDIE CHAIRS

INDICE

INDEX

SOMMAIRE

INHALTSVERZEICHNIS

ghost 14
DESIGN
CINI BOERI

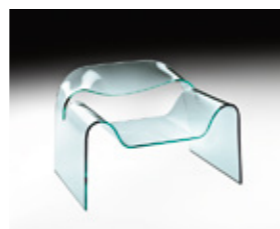

SCRIVANIE
DESKS
BUREAUX
SCHREIBTISCHE
16

atlas 56
DESIGN
DANNY LANE



bright 32
DESIGN
VALERIO COMETTI

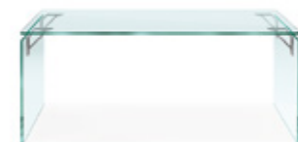

graph 52
DESIGN
XAVIER LUST



LLT 44
DESIGN DANTE O. BENINI
E LUCA GONZO



LLT ofx executive 48
DESIGN DANTE O. BENINI
E LUCA GONZO



rialto isola 28
DESIGN
CRS FIAM



rialto L 22
DESIGN
CRS FIAM



rialto L
wall mounted 26
DESIGN
CRS FIAM

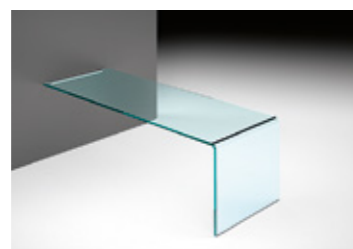

rialto scrivania 18
DESIGN
CRS FIAM



scribe 38
DESIGN
DANIEL LIBESKIND



TAVOLI RIUNIONI
MEETING TABLES
TABLES DE RÉUNION
BESPRECHUNGSTISCHE
60

LLT ofx meeting 62
DESIGN DANTE O. BENINI
E LUCA GONZO



luxor 66
DESIGN
RODOLFO DORDONI



LIBRERIE
BOOKSHELVES
BIBLIOTHÈQUES
BÜCHERREGALE
70

inori 72
DESIGN
SETSU E SHINOBU ITO

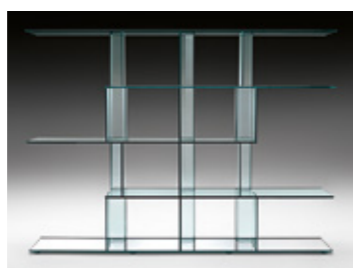

MENSOLE
SHELVES
ÉTAGÈRES
KONSOLE
70

mensole rialto L 76
DESIGN
CRS FIAM



CASSETTIERE
DRAWER UNITS
MEUBLES À TIROIRS
SCHUBLADENELEMENTE
70

luminare
cassettiera 83
DESIGN
ROBERTO PAOLI



rialto
cassettiera 80
DESIGN
CRS FIAM



HomeOffice: quando passione e lavoro sono di casa

FIAM, sempre attenta alle variazioni del gusto e degli stili di vita, spazia anche nell'arredo del settore Home/Office. Con le proprie linee creative esplora nuove opportunità di ambientazione, coerente alla propria "filosofia" aziendale, espressa con passione nell'estremo rigore del design e nella costante innovazione tecnologica. Il tavolo da lavoro diviene "elemento guida" nelle differenti esigenze e situazioni: per la scrivania di casa, quale protagonista in un elegante ufficio direzionale, al centro di un'importante sala riunioni; in un'ampissima gamma diversificata per stile e dimensioni, a cui armonizzare i numerosi complementi d'arredo della Collezione Fiam. Vengono proposti esemplari che spaziano dal modello Rialto "minimal di classe", al su misura totale della versione Rialto L; dalla scrivania Graph, espressione tecnologica della nostra tradizione, alla scrivania Atlas scolpita a mano dai maestri artigiani Fiam.

HomeOffice: when passion and craftsmanship feel at home

FIAM, always responsive to changes in taste and lifestyles, is now moving into Home/Office sector furniture. It explores new contexts for the use of its creative lines, which reflect its corporate "philosophy", expressed with great conviction in its high design values and constant technological innovation. The working table becomes the core element in the response to different needs and situations - as a desk in the home, the key feature of an elegant executive office, in the centre of prestige board room - in a very wide range, with different styles and dimensions, with which the various accompanying items in the Fiam Collection can be attractively combined. The types in the offering run from the "classy minimalist" Rialto model to the totally tailor-made Rialto L version; and from the Graph desk, a high-tech expression of our tradition, to the Atlas desk, hand-carved by Fiam's master craftsmen.

HomeOffice: quand passion et travail vont de pair

FIAM, toujours attentive aux changements de goûts et de styles de vie, opère également dans l'ameublement de la Maison et de Bureau. Grâce à ses nouvelles créations, elle explore de nouvelles solutions d'aménagement, en appliquant sa « philosophie » d'entreprise qui se traduit par l'extrême rigueur du design et une constante innovation technologique. La table de travail devient un "élément phare" dans les différentes situations: bureau de maison, vedette d'un élégant bureau de direction, au centre d'une grande salle de réunion. Disponible dans une large gamme de styles et de dimensions, elle peut être complétée par de nombreux compléments d'ameublement de la Collection Fiam. Sont proposés des exemplaires allant du modèle Rialto "minimaliste élégant" au sur mesure total de la version Rialto L; du bureau Graph, expression technologique de notre tradition, au bureau Atlas sculpté à la main par les maîtres artisans Fiam.

HomeOffice: wo leben und arbeiten zuhause sind

FIAM - stets am Puls der Zeit, wenn es um Änderungen des Lifestyles geht - auch bei der Einrichtung auf dem Home Office Sektor. Mit seinen kreativen Produktlinien geht FIAM neue Wege der Raumgestaltung, die ganz im Einklang mit der eigenen Unternehmensphilosophie steht und ihren leidenschaftlichen Ausdruck in strengem klassischem Design und stets innovativer Technologie findet. Der Arbeitstisch wird zum „Leitmotiv“ für verschiedene Ansprüche und Situationen - als Schreibtisch zu Hause, als Blickfang im eleganten Direktionsbüro oder als Herzstück eines wichtigen Besprechungsraumes. Eine breite Palette an verschiedenen Stilrichtungen und Größen, die sich mit zahlreichen Zusatzelementen der FIAM Kollektion kombinieren lassen, steht zur Auswahl. Angefangen vom Modell Rialto, dem „klassischen Minimal-produkt“ bis hin zur kompletten Lösung nach Maß des Modells Rialto L, vom Schreibtisch Graph, unserem klassischen High-Tech Produkt, bis hin zum Schreibtischmodell Atlas, der vom FIAM-Kunsthandwerkerteam in Handarbeit gedreht ist.

FIAM, cultura del vetro

Il vetro è un materiale magico ed eterno, quasi avesse un'intrinseca sacralità. Io ho accolto la sfida di questo materiale sin da quando ero ragazzo facendolo diventare praticamente una missione. Gettando le basi per un progetto che sembrava alle sue origini improbabile; far diventare il vetro in lastra un materiale protagonista nell'arredamento. Incanto e poesia, ecco quello che ancora mi trasmette il vetro. L'incanto di una materia senza tempo. La poesia è la vanità di una materia capace di riflettere ciò che ci circonda e di moltiplicare i nostri punti di vista sul reale.

FIAM, la culture du verre

Le verre est un matériau magique et éternel, qui semble posséder un caractère sacré intrinsèque. Dès mon plus jeune âge, j'ai voulu relever le défi de ce matériau, qui est bientôt devenu pour moi une mission. J'ai ainsi jeté les bases d'un projet qui semblait au départ improbable : conférer au verre en plaque une place de premier plan dans la décoration. Magie et poésie: ce sont les deux sensations que le verre m'a toujours procurées. La magie d'une matière intemporelle. La poésie, ou la vanité d'une matière capable de refléter tout ce qui nous entoure et de multiplier à l'infini nos perspectives sur la réalité.

FIAM, the art of glass

Glass is a magical and ever lasting material, as if it possessed an innate sacredness. I was young when I first accepted the challenge that this material represented and I set the basis for a project that initially seemed so unlikely possible: making glass become a furnishings star. Charm and poetry are still what glass conveys to me. The magic of a timeless material. Poetry is the vanity of a material capable of mirroring all that surrounds it and to multiply our perceptions of reality.

FIAM, die Kultur edles Glases

Glas ist ein zeitlos schönes Material mit magischer Ausstrahlung. Ich habe die Herausforderung dieses geheimnisvollen Materials schon in jungen Jahren angenommen, und in gewisser Weise zu meiner Mission auserkoren. Und damit die Grundlagen für ein Projekt geschaffen das zu Beginn beinahe aussichtslos erschien – die flache Glasscheibe zu einem Protagonisten der Einrichtung zu machen. Und auch heute noch vermittelt mir das Glas Zauber und Poesie. Den Zauber einer zeitlosen Materie. Die Poesie einer Materie, die ihre und unsere Umgebung reflektiert und unsere Blickpunkte auf die Realität vervielfacht.

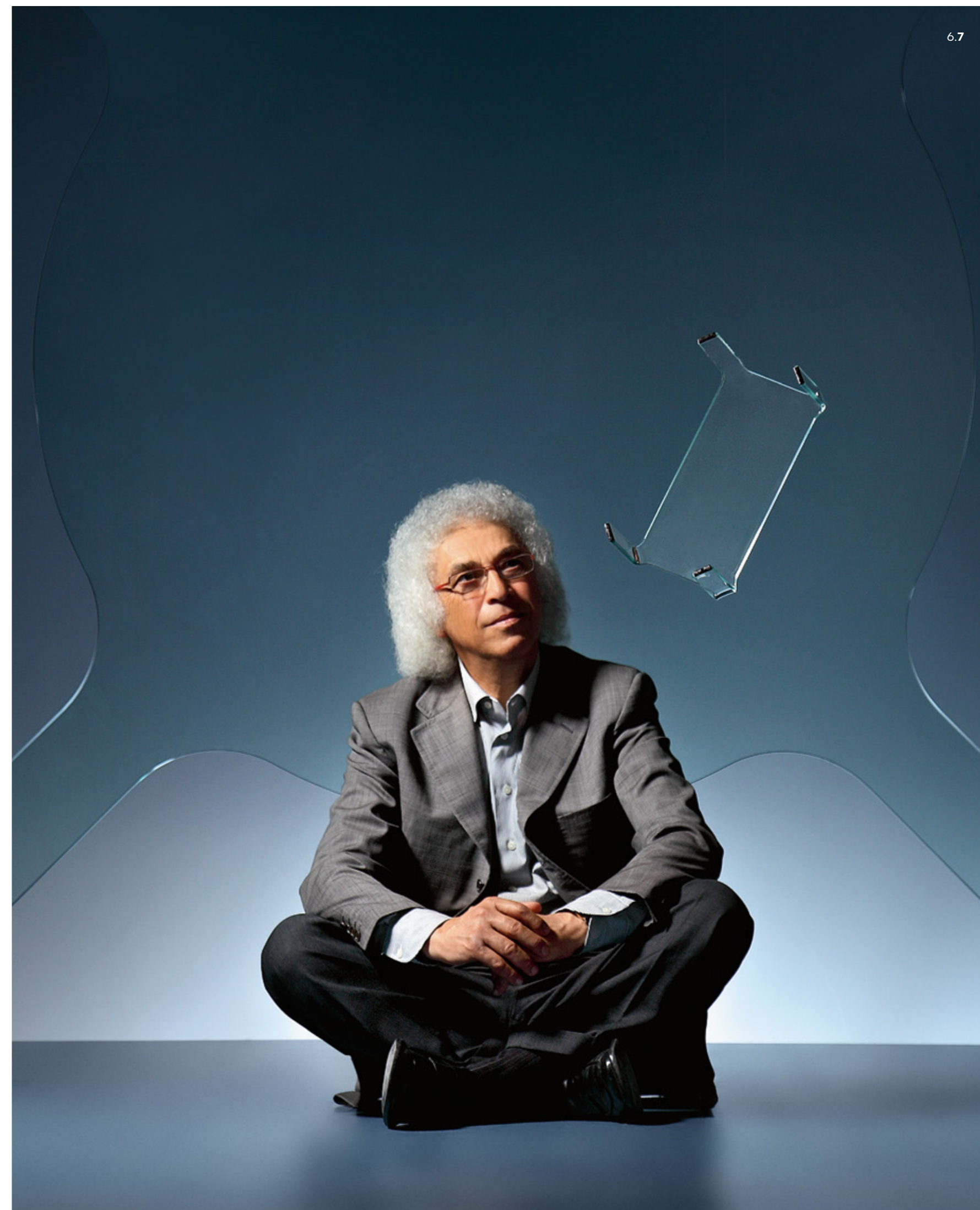



Vittorio Livi

Compasso d'Oro
alla carrieraPremio Leonardo
Qualità Italia 2015

Designer e riconoscimenti

Fiam Italia è stata più volte riconosciuta a livello globale come azienda di eccellenza ed innovazione, come dimostrano i numerosi premi ricevuti nel tempo, tra gli altri, il Premio Compasso d'Oro alla carriera ed il Premio Leonardo Qualità Italia.

Il Premio Compasso d'Oro è il più antico e più autorevole premio mondiale di design, istituito nel 1954 da un'idea di Gio Ponti. Fiam lo ha conseguito alla carriera nel 2001, come impresa che si è distinta con riconoscenza e prestigio in ambito progettuale, produttivo e di ricerca. Nel 2015 Il Comitato Leonardo, che da oltre venti anni riconosce e premia il talento di uomini ed imprese per dare rilevanza alle tante straordinarie eccellenze del Made in Italy, ha insignito Fiam del Premio Leonardo Qualità Italia come azienda che si è distinta per innovazione e qualità dei prodotti combinata con una forte proiezione internazionale, commerciale e produttiva.

Designers et prix

Fiam Italia a été maintes fois reconnue mondialement pour sa vocation à l'innovation et à l'excellence, comme en témoignent les nombreux prix remportés au fil du temps et dont, entre autres, le Prix Compasso d'Oro pour l'ensemble des réalisations et le Prix Leonardo Qualità Italia. Le prix Compasso d'Oro, soit le plus ancien et le plus influent prix international de design, a été créé en 1954 par Gio Ponti. Fiam a remporté le prix pour l'ensemble des réalisations en 2001 en tant qu'entreprise s'étant distinguée dans le domaine de la conception, de la fabrication et de la recherche, se voyant adjudiquer ainsi une des plus prestigieuses marque de reconnaissance du secteur. En 2015, le Comité Leonardo, qui depuis plus de vingt ans, reconnaît et récompense le talent des hommes et des sociétés pour souligner les multiples expressions de l'excellence du Made in Italy, a décerné le Prix Leonardo Qualità Italia à Fiam en tant que une société s'étant distinguée pour son innovation et la qualité exceptionnelle des produits, de son développement commercial et de la fabrication, ainsi que pour son caractère international.

Designers and awards

Fiam Italia has been repeatedly recognized globally as a company of excellence and innovation, as evidenced by the numerous awards received over time, among them, the Premio Compasso d'Oro (Golden Compass Award) for career and the Premio Leonardo Qualità Italia (Leonardo Award for Quality Italy). The Premio Compasso d'Oro is the oldest and most authoritative global design award, created in 1954 from an idea by Gio Ponti. Fiam has achieved the career award in 2001, as a company that has distinguished itself with gratitude and prestige in design, production, and research. In 2015, the Leonardo Committee, which has been recognizing and awarding the talent of men and companies to give relevance to the many extraordinary excellences of the Made in Italy for more than twenty years, has awarded Fiam with the Premio Leonardo Qualità Italia as a company that has distinguished itself for innovation and quality of products combined with a strong international outlook, for both commerce and production.

Designer und Preise

Wie die zahlreichen, im Laufe der Zeit von Fiam Italia erhaltenen Preise zeigen, wurde das Unternehmen aufgrund seiner Exzellenz und Innovation mehrfach international ausgezeichnet. Zu den Preisen gehören unter anderem der Preis Compasso d'Oro alla Carriera sowie der Preis Leonardo Qualità Italia. Der Preis Compasso d'Oro ist der älteste und renommierteste Preis für Design weltweit und wurde im Jahr 1954 von Gio Ponti gestiftet. Fiam erhielt diesen Preis nach seiner Erfolge im Jahr 2001 als Unternehmen, das sich durch Anerkennung und Ansehen im Bereich Projektplanung, Produktion und Forschung auszeichnet. Das Komitee Comitato Leonardo, das seit über 20 Jahren das Talent von Menschen und Firmen honoriert und prämiert, um besonders hervorragenden italienischen Produktionen Relevanz zukommen zu lassen, zeichnete Fiam im Jahr 2015 als Unternehmen, das sich durch innovative und qualitativ hochwertige Produkte in Kombination mit einer besonders starken internationalen, kommerziellen und produktiven Position kennzeichnet, mit dem Preis Leonardo Qualità Italia aus.



Archirivolto Design



Aquili Alberg



Bartoli Design



Cini Boeri



Luca Casini

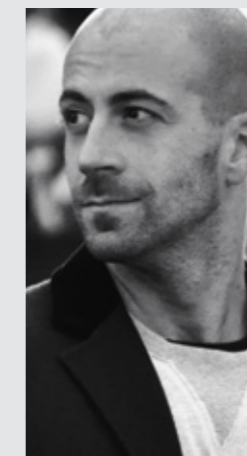

Valerio Cometti



Angelo Cortesi



Marzia e Leo Dainelli



Nicola De Ponti



Fabio Di Bartolomei



Rodolfo Dordoni



Doriana e Massimiliano Fuksas



Chafik Gasmî



Massimo Iosa Ghini



Dante O. Benini
e Luca Gonzo



Roberto Giacomucci



Makio Hasuike



Patrick Jouin



studio Klass



Danny Lane



Daniel Libeskind

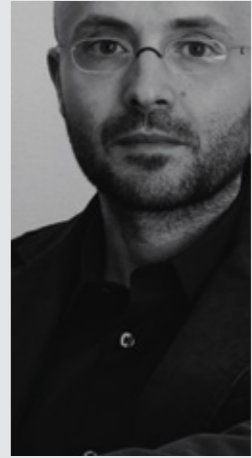

Luca Lo Bianco

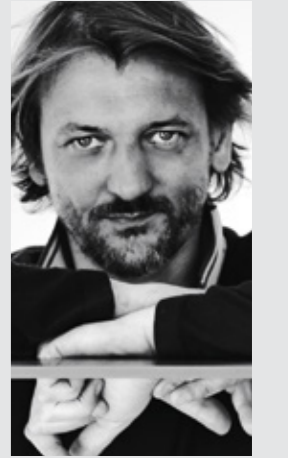

Xavier Lust



Vico Magistretti



Ilaria Marelli



Enzo Mari

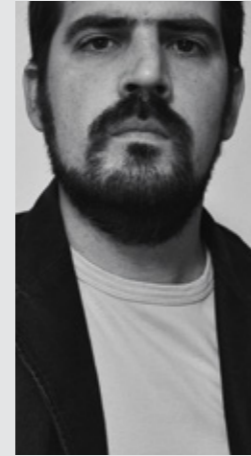

Francesco Mansueto

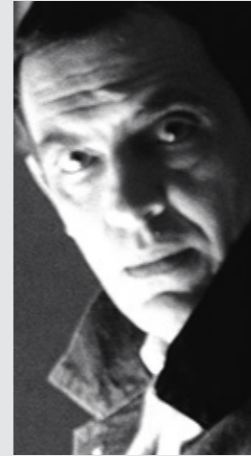

Massimo Morozzi



Matteo Nunziati



Satyendra Pakhalé



Roberto Paoli

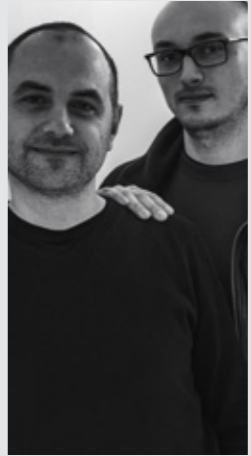

Lucidi Pevere



Christophe Pillet

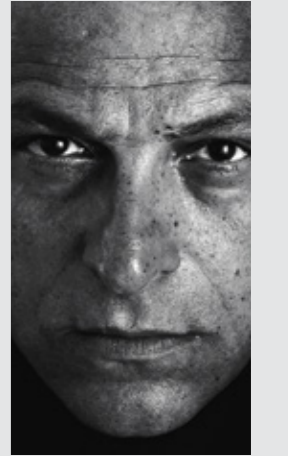

Prospero Rasulo



Paolo Rizzatto



Marta Laudani e Marco Romanelli



Gerussi - Sartoris



Roberto Semprini



Philippe Starck



Enrico Tonucci

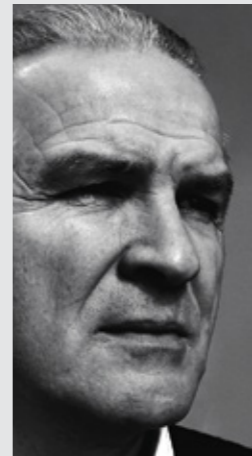

Elio Vigna



This Weber

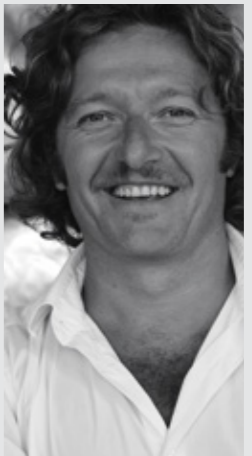

Helidon Xhixha

Il vetro: un simbolo dell'ecosostenibilità del futuro

Il vetro è natura. È costituito prevalentemente di sabbia e calce. È asettico, atossico e non rilascia alcuna sostanza nociva.

Il vetro è eterno e può essere riciclato all'infinito senza scarto. FIAM Italia valorizza le virtù del vetro attraverso i suoi processi produttivi che si svolgono nel pieno rispetto dell'ambiente.

Le verre: un symbole de l'avenir du développement durable

Le verre est naturel. Il est essentiellement composé de sable et de chaux.

Il est aseptique, atoxique et ne dégage pas de substance nocive. Le verre est éternel et peut être recyclé à l'infini sans déchet. FIAM Italia valorise les vertus du verre par des procédés de fabrication qui respectent pleinement l'environnement.

Glass: symbol of an ecosustainable future

Glass is nature. It consists mainly of sand and lime. It is aseptic and non-toxic and does not give off any harmful substances. Glass is eternal and can be recycled indefinitely without generating waste. FIAM Italia exploits the benefits of glass to the full through its environment-friendly production processes.

Glas – ein Symbol für Nachhaltigkeit, Umweltfreundlichkeit und Zukunft

Glas ist ein Stück Natur. Denn es besteht vorwiegend aus Sand und Kalk.

Es ist keimfrei, ungiftig und gibt keine schädlichen Stoffe ab. Glas hält ewig und kann ohne Rückstände immer wieder recycelt werden. FIAM Italia wertet die Vorteile des Glases dank umweltfreundlicher Produktionsverfahren zusätzlich auf.



ghost

NON AVREI MAI PENSATO DI FARE UNA POLTRONA IN VETRO...
LA MIA INIZIALE DIFFIDENZA PER UN'IDEA CHE SEMBRAVA
IRREALE FU SUPERATA DAL DESIDERIO/SFIDA DI VEDERE
SE FOSSE POSSIBILE CONCRETIZZARLA; E SE FIAM
SAREBBE STATA COSÌ BRAVA DA RIUSCIRE A REALIZZARLA.

I WOULD NEVER HAVE THOUGHT OF MAKING A CHAIR FROM GLASS...
MY INITIAL DISTRUST OF AN IDEA WHICH SEEMED QUITE UNREALISTIC
WAS OVERCOME BY THE DESIRE TO TAKE UP THE CHALLENGE
AND SEE WHETHER IT COULD ACTUALLY BE MADE, WHETHER FIAM
WOULD BE CLEVER ENOUGH TO TRANSFORM THE CONCEPT INTO REALITY.

JE N'AURAI JAMAIS PENSÉ RÉALISER UN JOUR UN FAUTEUIL EN VERRE ...
MA MÉFIANCE INITIALE À L'ÉGARD D'UNE IDÉE QUI SEMBLAIT IRRÉELLE
A ÉTÉ SURMONTÉE PAR LE DÉsir/LE DÉFI DE VOIR S'IL ÉTAIT POSSIBLE
DE LA CONCRÉTISER ET SI FIAM SERAIT À LA HAUTEUR DE LA RÉALISER.

NIE HÄTTE ICH GEDACHT, DASS ICH EINES TAGES EINEN STUHL
AUS GLAS MACHEN WÜRDE... MEIN ANFÄNGLICHES MISSTRAUEN
GEGENÜBER EINER IDEE, DIE MIR UNREALISTISCH ERSCIEN,
WURDE BALD DURCH DEN WUNSCH UND DEN EHRGEIZ VERDRÄNGT,
ZU SEHEN, OB ICH DIESE IDEE WIRKLICH UMSETZEN KANN UND OB FIAM
ES SCHAFFEN WÜRDE, DIE VON MIR UMGESETZTE IDEE ZU REALISIEREN.

CINI BOERI



atlas	56
bright	32
graph	52
LLT	44
LLT ofx executive	48
rialto isola	28
rialto L	22
rialto L wall mounted	26
rialto scrivania	18
scribe	38



SCRIVANIE DESKS BUREAUX SCHREIB- TISCHE

Scrivania.
Desk.
160 x 80 x 73 cm
63" x 31 1/2" x 28 3/4"
Sedia Plie.
Plie chair.
Cassettiera Luminare.
Luminare drawer unit.
Mensole Babila.
Babila shelves.



rialto scrivania

DESIGN CRS FIAM

Collezione di scrivanie
in vetro curvato da 15 mm
disponibili in varie misure.
Su richiesta:
profili in alluminio
brillantato. Disponibile
anche su misura.

Collection of desks
in 15 mm curved glass,
available in various sizes.
On request: strips
in polished aluminium.
Also available
custom-sized.

Collection de bureaux
en verre cintré de 15 mm
disponibles dans
plusieurs dimensions.
Sur demande: profils
en aluminium brillanté.
Egalement disponible
sur mesure.

Kollektion von
Schreibtischen aus 15 mm
starkem gebogenem Glas
in diversen Abmessungen.
Auf Wunsch: geblänzte
Aluminiumprofile. Auch als
Maßanfertigung lieferbar.

Scrivania.
Desk.

160 x 80 x 73 cm
63" x 31 1/2" x 28 3/4"

Sedia Plié.
Plié chair.

Cassettiera Luminare.
Luminare drawer unit.





Scrivania con cassetteria.
Desk with drawer unit.

160 x 70 x 73 cm
63" x 27 9/16" x 28 3/4"

Sedia Dress.
Dress chair.



rialto L

DESIGN CRS FIAM

Scrivania in vetro curvato da 15 mm, abbinata a cassettera in legno laccato opaco nei colori bianco o nero con frontali in vetro verniciati in abbinamento al colore della struttura. Disponibile anche su misura.

Desk in 15 mm curved glass combined with drawer unit in white or black matt lacquered wood, with fronts in glass varnished to match the structure colour. Also available custom-sized.

Bureau en verre cintré de 15 mm, avec meuble à tiroirs en bois laqué opaque dans les coloris blanc ou noir avec façades en verre vernies de couleur assortie à la structure. Egalement disponible sur mesure.

Schreibtisch aus 15 mm starkem gebogenem Glas, kombiniert mit Schubladenelement aus matt lackiertem Holz in Weiß oder Schwarz mit Fronten aus farblich zum Korpus passend lackiertem Glas. Auch als Maßanfertigung lieferbar.

Scrivania con cassettera.
Desk with drawer unit.

160 x 70 x 73 cm
63" x 27 9/16" x 28 3/4"

Sedia Dress.
Dress chair.

rialto L wall mounted

DESIGN CRS FIAM

Scrivania a parete in vetro curvato da 15 mm, abbinata ad una doppia piastra in alluminio brillantato per fissaggio a parete. Disponibile anche su misura (dimensione minima 90 x 60 x 73 cm, dimensione massima 210 x 100 x 73 cm).

Wall-mounted desk in 15 mm curved glass combined with a double polished aluminium plate for wall-mounting. Also available custom-sized (minimum size: 90 x 60 x 73 cm, maximum size: 210 x 100 x 73 cm).

Bureau murale en verre cintré de 15 mm, assorti à une double plaque en aluminium poli pour fixation murale. Egalement disponible sur mesure (dimensions minimales: 90 x 60 x 73 cm, dimensions maximales: 210 x 100 x 73 cm).

Schreibtisch an Wand aus 15 mm starkem, gebogenem Glas, kombiniert mit einer doppelten Leiste aus poliertem Aluminium zur Befestigung an der Wand. Auch als Maßanfertigung lieferbar (mind. 90 x 60 x 73 cm - max. 210 x 100 x 73 cm).

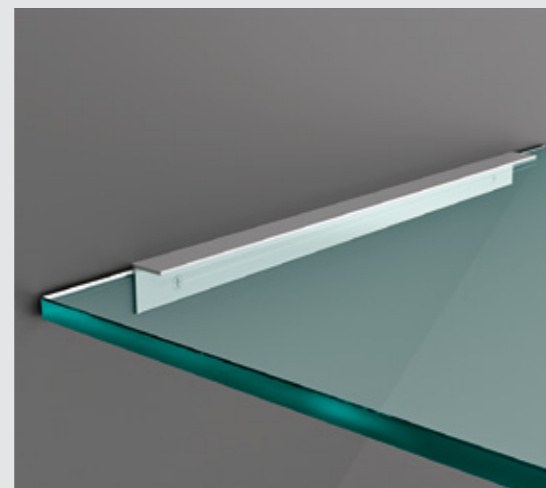
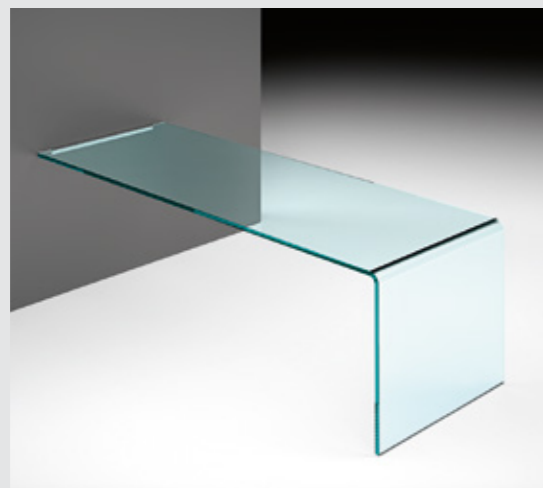

Scrivania.
Desk.

160 x 70 x 73 cm
63" x 27 9/16" x 28 3/4"





Scrivania.
Desk.
Piano principale / main top:
170 x 70 x 73 cm
67" x 27 1/16" x 28 3/4"
Piano di servizio / Side shelf:
140 x 50 x 60 cm
55 1/8" x 19 1/16" x 23 5/8"
Cassettiera Luminare.
Luminare drawer unit.
Mensole Rialto L.
Rialto L shelves.
Sedia Kamy.
Kamy chair.

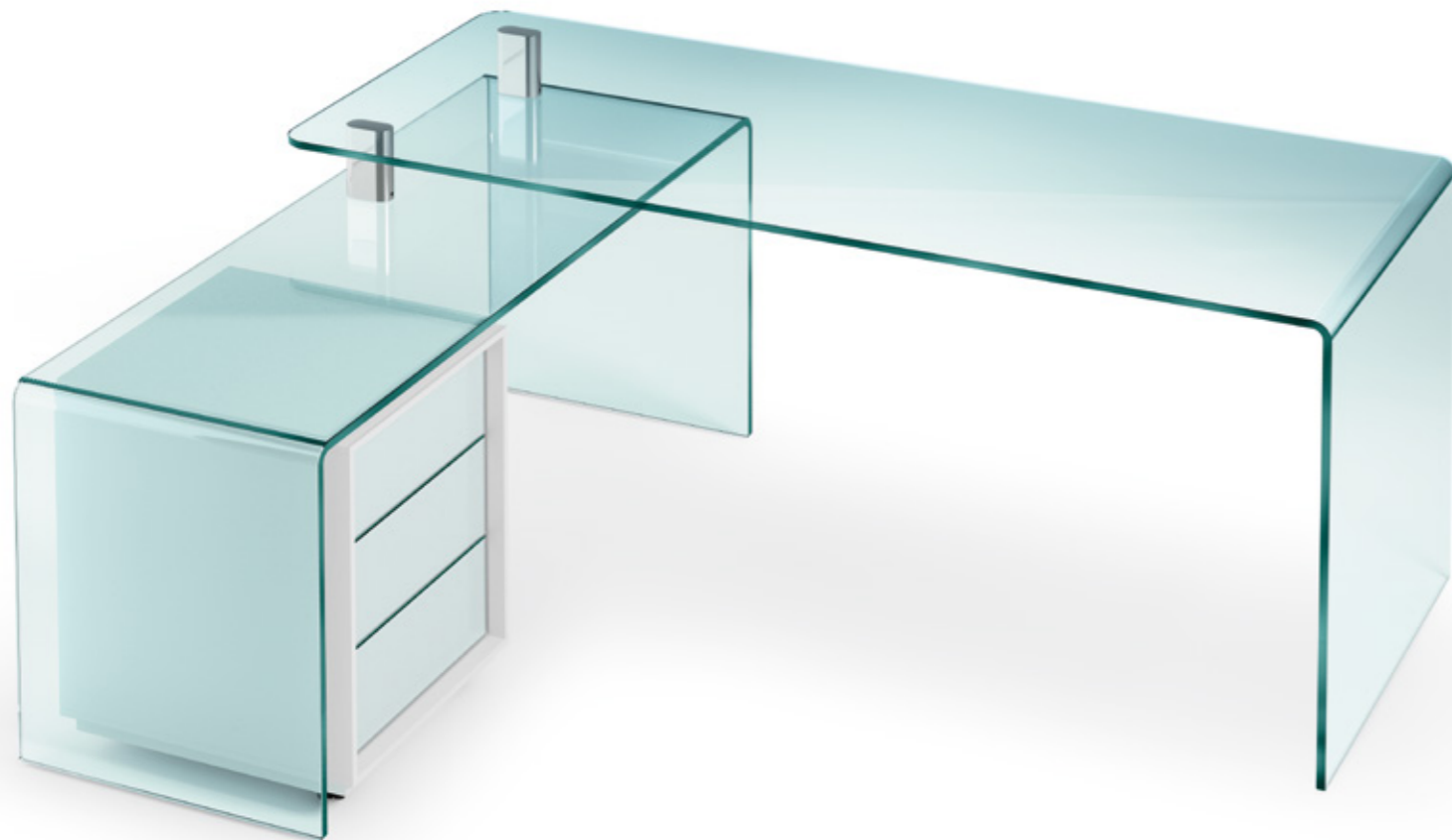

rialto isola

DESIGN CRS FIAM

Scrivania composta da un ripiano principale e da un ripiano di servizio in vetro trasparente curvato da 15 mm sul lato sinistro. Disponibile anche su misura. Su richiesta: profili in alluminio brillantato.

Desk comprising a main top and a shelf in curved 15 mm transparent glass on the left side. Also available custom-sized. On request: strips in polished aluminium.

Bureau constitué d'un plateau principal et d'un plateau de service en verre transparent cintré de 15 mm. Egalement disponible sur mesure. Sur demande: profiles en aluminium brillanté.

Schreibtisch mit Querplatte aus 15 mm starkem, gebogenem, transparentem Glas. Auch Maßanfertigungen lieferbar. Auf Wunsch: geglänzte Aluminiumprofile.

Scrivania.
Desk.

Piano principale / Main top:
170 x 70 x 73 cm
67" x 27 9/16" x 28 3/4"

Piano di servizio / Side shelf:
140 x 50 x 60
55 1/8" x 19 11/16" x 23 5/8"

Cassettiera Luminare.
Luminare drawer unit.



Scrivanìa.
Desk.
180 x 80 x 73 cm
70 7/8" x 31 1/2" x 28 3/4"
Specchio **Caadre TV**.
Caadre TV mirror.

bright

DESIGN VALERIO COMETTI +V12 DESIGN

Scrivania in vetro temperato da 15 mm smontabile con supporti di fissaggio in alluminio ed acciaio. Disponibile anche su misura.

Desk in 15 mm-thick tempered glass with aluminium and steel mounting supports. Also available custom-sized.

Bureau en verre trempé de 15 mm démontable équipée de supports de fixation en aluminium et acier. Egalement disponible sur mesure.

Schreibtisch aus 15 mm starkem, gehärtetem Glas, zerlegbare Ausführung mit Aluminium und Stahl-Befestigungselementen. Auch als Maßanfertigung lieferbar.



Scrivania.
Desk.
180 x 80 x 73 cm
70 7/8" x 31 1/2" x 28 3/4"
Specchio Caadre TV.
Caadre TV mirror.





Scrivanica.
Desk.
180 x 80 x 73 cm
70 7/8" x 31 1/2" x 28 3/4"
Sedie Kamy.
Kamy chairs.



Scrivania a tiratura limitata.
Limited edition desk.

180 x 75 x 73 cm
70 7/8" x 29 1/2" x 28 3/4"

Sedia **Kamy**.
Kamy chair.

Cassettiera **Luminare**.
Luminare drawer unit.

Mirage, composizione di specchi sagomati.
Mirage, shaped mirrors composition.





scribe

DESIGN DANIEL LIBESKIND

Scrivania composta da due basi in vetro curvato da 12 mm retroargentato e piano in vetro da 12 mm, con porzioni retroargentate.

La scrivania prevede una serie a tiratura limitata: 40 pezzi unici numerati per celebrare il 40° Anniversario Fiam.

Desk composed of two 12 mm curved silvered glass bases and a glass top 12 mm thick, with silvered parts.

In limited edition: 40 numbered pieces celebrating Fiam 40th Anniversary.

Bureau constitué de deux bases en verre miroitié de 12 mm et d'un plateau en verre de 12 mm avec parties miroitiées.

Prévu une édition limitée: 40 pièces numérotées pour célébrer le 40e anniversaire Fiam.

Schreibtisch mit zwei Basis aus 12 mm verspiegeltem Glas und einer Platte aus 12 mm Glas mit verspiegelten Teilen.

In limitierter Auflage: 40 nummerierte Exemplare, zum 40. Jahrestag Fiam.

Scrivania a tiratura limitata.
Limited edition desk.

180 x 75 x 73 cm
70 7/8" x 29 1/2" x 28 3/4"

Sedie Kamy.
Kamy chairs.

Lampada L'Astra.
L'Astra table lamp.



Scrivanía a tiratura limitata.
Limited edition desk.
180 x 75 x 73 cm
70 7/8" x 29 1/2" x 28 3/4"
Cassetiera Luminare.
Luminare drawer unit.
Librería Inori.
Inori bookcase.

LLT

DESIGN DANTE O.BENINI E LUCA GONZO

Scrivania con piano in vetro trasparente da 15 con bisellatura su due lati corti, struttura gambe in vetro trasparente saldato da 15 con bisellatura sul bordo. Particolari di fissaggio in acciaio inox. Disponibile anche con piani su misura.

Desk composed of a 15 thick transparent glass top with bevelled edges on the two shorter sides and of a base in 15 mm thick transparent welded glass with bevelled edge. Fastening elements in stainless steel. Also available with tops of customized size.

Bureau se composant d'un plateau en verre transparent de 15 mm avec biseautage sur les deux côtés courts et d'un piétement en verre transparent soudé, épaisseur 15 mm, avec bords biseautés. Éléments de fixation en acier inoxydable. Également disponible avec plateau sur mesure.

Schreibtisch mit Platte aus transparentem 15 mm starkem Glas, Facettenschliff auf den zwei kürzeren Seiten. Untergestell aus transparentem 15 mm starkem verschweisstem Glas, Facettenschliff auf den Kanten. Verbindungselemente aus Edelstahl. Auch mit Maßgefertigter Platte.

Scrivania.
Desk.

180 x 80 x 72 cm
70 7/8" x 31 1/2" x 28 3/8"





Scrivania.
Desk.
160 x 70 x 72 cm
63" x 27 9/16" x 28 3/8"



Scrivanìa.
Desk.
180 x 90 x 74 cm
70 7/8" x 35 7/16" x 29 1/8"
Cassettera **Rialto**.
Rialto drawer unit.
Consolle **LLT**.
LLT console.
Lampada **L'Astra**.
L'Astra table lamp.



LLT ofx executive

DESIGN DANTE O.BENINI E LUCA GONZO

Collezione di scrivanie direzionali in vetro trasparente da 19 mm. Il piano è appoggiato sulle basi in vetro saldato e i fori presenti hanno la funzione di passacavi. LLT ofx executive è disponibile anche con piani su misura, fino ad una lunghezza di 260 cm.

Collection of executive desks in 19 mm thick transparent glass. The top rests on the bases in welded transparent glass and is equipped with cable entry holes. LLT ofx executive is also available with custom-sized top up to 260 cm length.

Collection des bureaux se composant d'un plateau en verre transparent de 19 mm et d'un piétement en verre transparent soudé. Trous pour le passage des cables. Disponible avec plateau sur mesure jusqu'à une longueur de cm 260.

Kollektion von Schreibtischen Besprechungstisch mit Platte aus transparentem 19 mm starkem Glas, und Untergestell aus transparentem 19 mm starkem verschweisstem Glas. Kabelführungslöcher. Auch mit Maßgefertigter Platte erhältlich bis max. Länge von 260 cm.



Scrivania.
Desk.
220 x 80 x 74 cm
86 5/8" x 31 1/2" x 29 1/8"
Cassettera **Luminare**.
Luminare drawer unit.
Mirage, composizione
di specchi sagomati.
Mirage, shaped mirrors
composition.

graph

DESIGN XAVIER LUST

Scrivania composta da base in vetro trasparente curvato da 19 mm e piano in vetro trasparente da 15 mm con piastre di aggancio in acciaio inox.

Desk with base in 19 mm curved transparent glass and 15 mm transparent glass top with stainless steel connecting plates.

Bureau composé d'une base en verre transparent cintré de 19 mm et d'un plateau en verre transparent de 15 mm avec plaques de fixation en acier inoxydable.

Schreibtisch mit Untergestell aus 19 mm starkem, gebogenem, transparentem Glas und 15 mm starker, transparenter Glasplatte mit Befestigungselementen aus Edelstahl.

Scrivania.
Desk.
220 x 80 x 74 cm
86 5/8" x 31 1/2" x 29 1/8"
Cassettiera Luminare.
Luminare drawer unit.





Scrivanía.
Desk.
240 x 120 x 74 cm
94 1/2" x 47 1/4" x 29 1/8"

atlas

DESIGN DANNY LANE

Scrivania con piano in vetro temperato da 20 mm. Gambe composte da sezioni di vetro scolpito a mano di spessore 20 mm ed incollate l'una sull'altra. Disponibile anche con piano su misura.

Desk with tempered glass top 20 mm thick. Legs consisting in sections of hand-sculpted glass 20 mm thick, glued one on top of the other. Also available with custom-sized top.

Bureau avec plateau en verre trempé de 20 mm. Pieds composés de sections en verre sculpté à la main d'une épaisseur de 20 mm et collées l'une sur l'autre. Egalement disponible avec plateau sur mesure.

Schreibtisch mit 20 mm starker Platte aus gehärtetem Glas. Beine aus aufeinander geklebten, 20 mm starken, handbehauenen Glaselementen. Auch mit maßgefertigter Platte erhältlich.



Scrivania.
Desk.
240 x 120 x 74 cm
94 1/2" x 47 1/4" x 29 1/8"

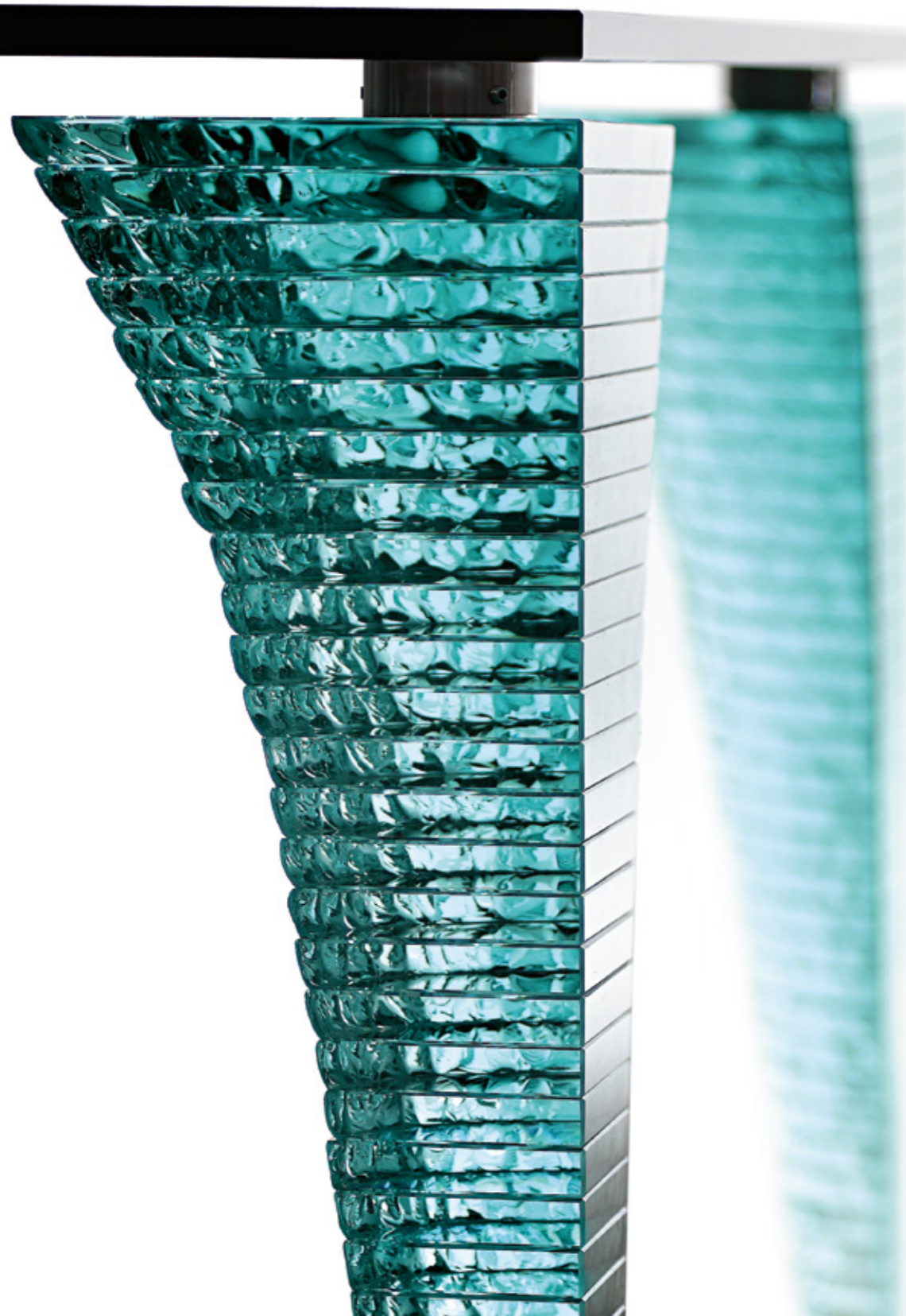

LLT ofx meeting
luxor

62

66

60.61

TAVOLI RIUNIONI
MEETING TABLES
TABLES DE RÉUNION
BESPRECHUNGS
TISCHE

A black and white photograph of a modern meeting room. In the center, a glass-topped meeting table is surrounded by several dark-colored chairs. To the right, a dark wood bookshelf is filled with books and a lamp. A large window in the background shows a view of trees and a lawn. The floor is made of light-colored wood planks.

Tavolo riunioni.
Meeting table.
350 x 120 x 74 cm
137 13/16" x 47 1/4" x 29 1/8"
Sedia Dress.
Dress chair.
Consolle LLT.
LLT consolle.
Tavolino Magique.
Magique low table.



LLT ofx meeting

DESIGN DANTE O.BENINI E LUCA GONZO

Tavolo riunioni in vetro trasparente da 19 mm. Il piano è appoggiato sulle basi in vetro saldato e i fori presenti hanno la funzione di passacavi. LLT ofx meeting è disponibile anche con piani su misura, fino ad una dimensione massima 350x120 cm.

Meeting table in 19 mm thick transparent glass. The top rests on the bases in welded transparent glass and is equipped with cable entry holes. LLT ofx meeting is also available with custom-sized top up to 350x120 cm.

Table de réunion se composant d'un plateau en verre transparent de 19 mm et d'un piétement en verre transparent soudé avec des trous pour le passage des cables. Disponible avec plateau sur mesure jusqu'à 350x120 cm.

Besprechungstisch mit Platte aus transparentem 19 mm starkem Glas, und Untergestell aus transparentem 19 mm starkem verschweisstem Glas. Kabelführungslöcher. Auch mit maßgefertigter Platte erhältlich bis max. 350x120 cm.

Tavolo riunioni.
Meeting table.
350 x 120 x 74 cm
137 13/16" x 47 1/4" x 29 1/8"





Tavolo riunioni.
Meeting table.
350 x 120 x 74 cm
137 13/16" x 47 1/4" x 29 1/8"
Libreria Inori.
Inori bookcase.
Sedia Plié.
Plié chair.

luxor

DESIGN RODOLFO DORDONI

Tavolo con piano in vetro fumé o bronzo stratificato da 8+8 mm finitura filo lucido tondo, disponibile anche in vetro trasparente o extralight da 12 e da 15 mm. A seconda della misura e della configurazione desiderata base composta da 2, 3 o 4 cilindri (Ø 40 cm) in vetro da 10 mm, fumé, bronzo, NERO 95, trasparente o extralight, extralight retroverniciato bianco o retroargentato verniciato bianco. È possibile realizzare il piano su misura.

Table with a 8 mm +8 mm laminated smoked or bronze glass top, shiny polished edge, also available in transparent glass or extralight glass (12 or 15 mm thick). 10 mm-thick curved glass bases, composed of 2, 3 or 4 cylinders (Ø 40 cm) depending on the size and the shape requested. The glass bases available in the following finishings: transparent, extralight, extralight white back-stained or extralight back-silvered white stained, Black 95 (NERO 95), smoked or bronze. It is possible to order custom-sized tops.

Table avec plateau en verre feuilleté de 8+8 mm fumé ou bronze, finition bord poli arrondi, disponible aussi en verre transparent ou extralight de 12 ou 15 mm. Selon la mesure ou la configuration choisie, base composée par 2, 3 ou 4 cylindres (Ø 40 cm) en verre de 10 mm. fumé, bronze, Noir 95 (NERO 95), transparent ou extralight, extralight verni dessous blanc, extralight argenté verni dessous blanc. Plateau disponible aussi en version sur mesure.

Tisch mit 8+8 mm-starker Schichtglasplatte in Rauch- oder Bronze-Glas oder in transparentem bzw. extralight Glas, 12 oder 15 mm Stärke. Untergestell bestehend aus 2, 3 bzw. 4 Glas-Zylindern (Durchmesser 40 cm) abhängig von den gewünschten Massen und Gestaltung, 10 mm. Glasstärke. Lieferbar in den folgenden Ausführungen: Rauch- oder Bronzeglas, Schwarz 95 (NERO 95)-Glas, transparentes bzw. extralight-Glas, weiss lackiertes extralight-Glas oder extraligh-Glas versilbert mit Weiß Lackierung. Die Tischplatte kann nach Maß bestellt werden.

Tavolo riunioni.
Meeting table.
350 x 120 x 74 cm
137 13/16" x 47 1/4" x 29 1/8"
Libreria Inori.
Inori bookcase.
Sedia Plié.
Plié chair.



LIBRERIE, MENSOLE,
CASSETTIERE

BOOKSHELVES,
SHELVES,
DRAWER UNITS

BIBLIOTHÈQUES,
ÉTAGÈRES, MEUBLES
À TIROIRS

BÜCHERREGALE,
KONSOLE,
SCHUBLADEN
ELEMENTE

inori	72
luminare cassettera	83
mensole rialto L	76
rialto cassettera	80



Libreria - espositore.
Bookcase - display unit.
240 x 36,5 x 180 cm
94 1/2" x 14 3/8" x 70 7/8"
Sedia Plié.
Plié chair.
Tavolo Luxor.
Luxor table.

inori

DESIGN SETSU E SHINOBU ITO

Sistema composto da elementi in vetro o legno modulari. La modularità e versatilità ne permette l'utilizzo come libreria, espositore, contenitore, porta Tv.

Il sistema si sviluppa anche in situazione autoportanti (INORI FREESTANDING): nelle versioni in vetro e nella misura larga cm 240, da altezza minima 135 cm sino all'altezza massima 180 cm il sistema prevede delle barre di irrigidimento in alluminio anodizzato nero.

System consisting of modular glass or wood elements. Its modularity and versatility allow it to be used as a bookcase, display case, storage unit or TV unit.

The system can also be used to construct free-standing compositions (INORI FREESTANDING): in glass versions and in width 240 cm, from a height of minimum 135 cm up to the maximum height of 180 cm the system is complete with black anodised aluminium reinforcement bars.

Système composé d'éléments modulaires en verre ou bois. Sa modularité et sa polyvalence permettent de l'utiliser comme une bibliothèque, un présentoir, un meuble de rangement, un meuble TV.

Possibilité de système autoporteur (INORI FREESTANDING): dans les versions en verre et dans la largeur de 240 cm, d'une hauteur minimale de 135 cm jusqu'à une hauteur maximale de 180 cm, le système est doté de barres d'armature en aluminium anodisé noir.

System aus modularen Glas-oder Holz-Elementen. Vielseitig einsetzbar und beliebig kombinierbar, als Bücherregal, Ausstellungsregal, TV-Element usw.

Auch freistehend als Raumteiler (INORI FREESTANDING) aus Glas Breite 240 cm, Höhe mindestens 135 cm, maximal 180 cm, mit Verstärkungen aus Schwarz eloxiertem Aluminium.

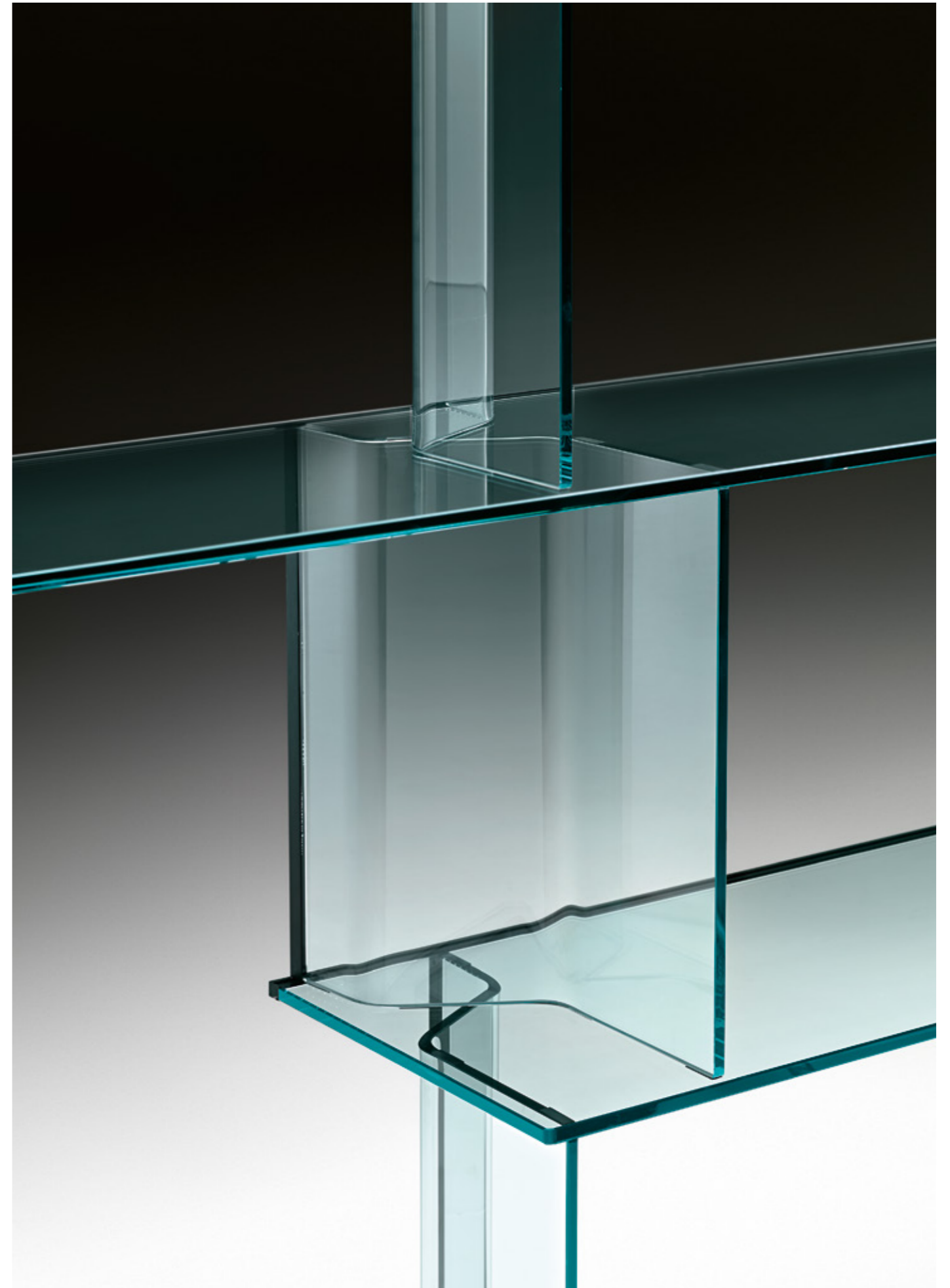



Mensole.
Shelves.

100 x 24 x 36 cm
39 3/8" x 9 7/16" x 14 3/16"

140 x 24 x 40 cm
55 1/8" x 9 7/16" x 15 3/4"

mensole rialto L

CRS FIAM

Mensole in vetro curvato da 10 mm. Reggimensola in metallo cromato. Le mensole sono disponibili anche su misura con i seguenti limiti: lunghezza: da 65 cm a 190 cm; profondità: da 24 cm a 30 cm; altezza: fino a 36 cm per lunghezze entro i 100 cm e fino a 70 cm per lunghezze oltre i 100 cm. L'interasse massimo tra i reggimensola è di 70 cm.

Shelves in 10 mm curved glass. Chromed metal brackets. The shelves are also available custom-sized with the following limits: length: from 65 cm to 190 cm; depth: from 24 cm to 30 cm; height: up to 36 cm for lengths up to 100 cm and up to 70 cm for lengths over 100 cm. The maximum gap between brackets is 70 cm.

Etagères en verre cintré de 10 mm Supports d'étagère en métal chromé. Les étagères sont également disponibles sur mesure avec les limites suivantes : longueur: de 65 cm à 190 cm, profondeur : de 24 cm à 30 cm, hauteur : jusqu'à 36 cm pour les longueurs inférieures à 100 cm et jusqu'à 70 cm pour les longueurs supérieures à 100 cm. La distance maximale entre les supports d'étagère est de 70 cm.

Konsole aus 10 mm starkem, gebogenem Glas. Konsolehalterungen aus verchromtem Metall. Auch maßgefertigt lieferbar in Längen von 65 bis 190 cm, Tiefen von 24 bis 30 cm, Höhen bis 36 cm für Längen bis 100 cm, Höhen bis 70 cm für Längen über 100 cm. Maximaler Mittenabstand zwischen den Halterungen 70 cm.

Mensole.
Shelves.

100 x 24 x 36 cm
39 3/8" x 9 7/16" x 14 3/16"

140 x 24 x 40 cm
55 1/8" x 9 7/16" x 15 3/4"





Cassettera.
Drawer unit.
48 x 45 x 67 cm
18 7/8" x 17 1/16" x 26 3/8"
Scrivanja Rialto.
Rialto desk.

rialto cassetiera

DESIGN CRS FIAM

Cassetiera in vetro curvato trasparente da 8 mm. La struttura dei cassetti è in legno laccato bianco. La cassetiera è provvista di 2 cassetti con sistema di chiusura automatica soft. Ruote e maniglie cromate.

Drawer unit in 8 mm curved transparent glass. The drawers have white lacquered wood frame. The drawer unit features 2 drawers with automatic soft closure system. Chromed wheels and handles.

Meuble à tiroirs en verre cintré transparent de 8 mm. La structure des tiroirs est en bois laqué blanc. Le meuble à tiroirs est doté de 2 tiroirs avec système de fermeture automatique amortie. Roulettes et poignées chromées.

Kommode aus 8 mm starkem, transparentem, gebogenem Glas. Zargen der Schubladen aus weiß lackiertem Holz. 2 Schubladen mit automatischen Soft-Close-Einzug. Räder und Griffe verchromt.



Cassetiera.
Drawer unit.
48 x 45 x 67 cm
18 7/8" x 17 11/16" x 26 3/8"

luminare cassetiera

DESIGN CRS FIAM

Cassetiera in legno laccato opaco nei colori bianco o nero. Disponibile con 3 o 4 cassetti. I frontali sono in vetro da 6 mm verniciati in abbinamento al colore della struttura. Disponibile anche con ruote piroettanti.

Drawer unit in white or black matt lacquered wood. Available with 3 or 4 drawers. The fronts are in 6 mm glass varnished to match the carcass colour. Also available with castors.

Meuble à tiroirs en bois laqué opaque dans les coloris blanc ou noir. Disponible avec 3 ou 4 tiroirs. Les façades sont en verre de 6 mm et peintes dans la même teinte que la structure. Egalement disponible avec des roulettes pivotantes.

Schubladenelement aus matt lackiertem Holz in Weiß oder Schwarz, mit 3 oder 4 Schubladen. Fronten aus 6 mm starkem, lackiertem Glas in der Korpusfarbe. Auch mit Lenkrollen.



Cassetiera.
Drawer unit.
45 x 48 x 70 cm
17 11/16" x 18 7/8" x 27 9/16"
45 x 48 x 54 cm
17 11/16" x 18 7/8" x 21 1/4"

SCRIVANIE DESKS	atlas	88
	bright	89
	graph	90
	LLT	91
	LLT ofx executive	92
	rialto isola	93
	rialto L	94
	rialto L wall mounted	95
	rialto scrivania	96
scribe	97	
TAVOLI RIUNIONI MEETING TABLES	LLT ofx meeting	98
	luxor	99
LIBRERIE, MENSOLE, CASSETTIERE BOOKSHELVES, SHELVES, DRAWER UNITS	inori	100
	inori freestanding	101
	luminare cassettera	107
	mensole rialto L	108
	rialto cassettera	109

SCHEDE
TECNICHE
TECHNICAL
DATA SHEETS
FICHES
TECHNIQUE
DATENBLÄTTER

ghost

DESIGN
CINI BOERI



Poltrona in vetro
curvato da 12 mm.

Monolithic chair
in 12 mm-thick
curved glass.

Fauteuil en verre cintré
d'une seule dalle
de verre de 12 mm.

Sessel aus gebogenem
12 mm-starkem Glas,
aus einer einzigen
Glasplatte gefertigt.

95 x 75 x 68
37 3/8 x 29 1/2" x 26 3/4"

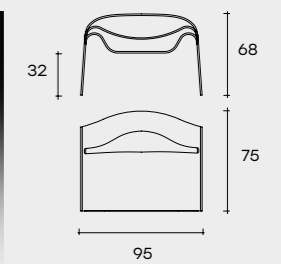
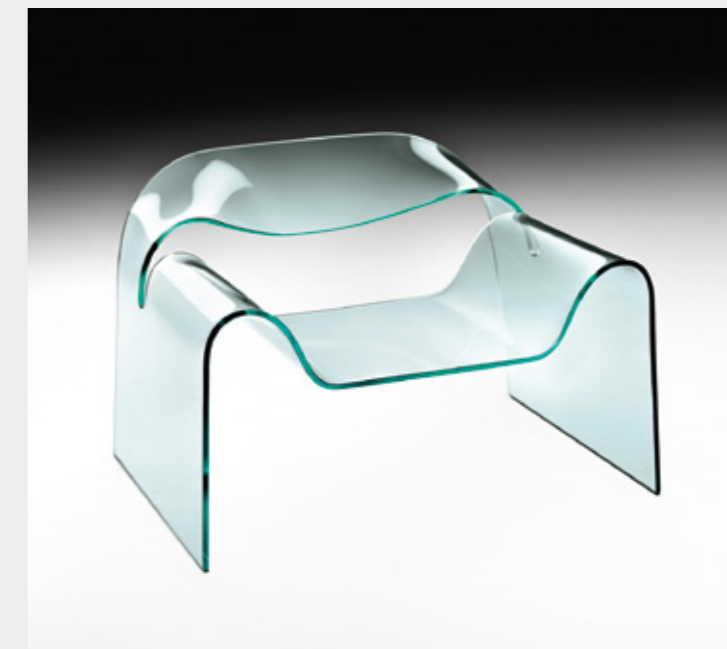

atlas

DESIGN
DANNY LANE



Scrivania con piano in vetro temperato da 20 mm. Gambe composte da sezioni di vetro scolpito a mano di spessore 20 mm ed incollate l'una sull'altra. Disponibile anche con piano su misura.

Desk with tempered glass top 20 mm thick. Legs consisting in sections of hand-sculpted glass 20 mm thick, glued one on top of the other. Also available with custom-sized top.

Bureau avec plateau en verre trempé de 20 mm. Pieds composés de sections en verre sculpté à la main d'une épaisseur de 20 mm et collées l'une sur l'autre. Egalement disponible avec plateau sur mesure.

Schreibtisch mit 20 mm starker Platte aus gehärtetem Glas. Beine aus aufeinander geklebten, 20 mm starken, handbehauenen Glaselementen. Auch mit maßgefertigter Platte erhältlich.

220 x 100 x 74 cm
86 5/8" x 39 3/8" x 29 1/8"
240 x 120 x 74 cm
94 1/2" x 47 1/4" x 29 1/8"

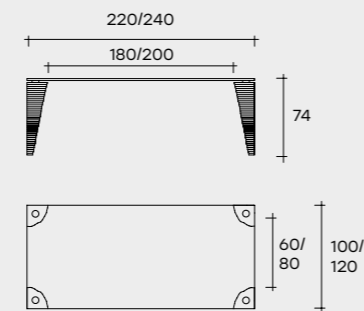

bright

DESIGN
VALERIO COMETTI
+V12 DESIGN



Scrivania in vetro temperato da 15 mm smontabile con supporti di fissaggio in alluminio ed acciaio. Disponibile anche su misura.

Desk in 15 mm-thick tempered glass with aluminium and steel mounting supports. Also available custom-sized.

Bureau en verre trempé de 15 mm démontable équipée de supports de fixation en aluminium et acier. Egalement disponible sur mesure.

Schreibtisch aus 15 mm starkem, gehärtetem Glas, zerlegbare Ausführung mit Aluminium und Stahl-Befestigungselementen. Auch als Maßanfertigung lieferbar.

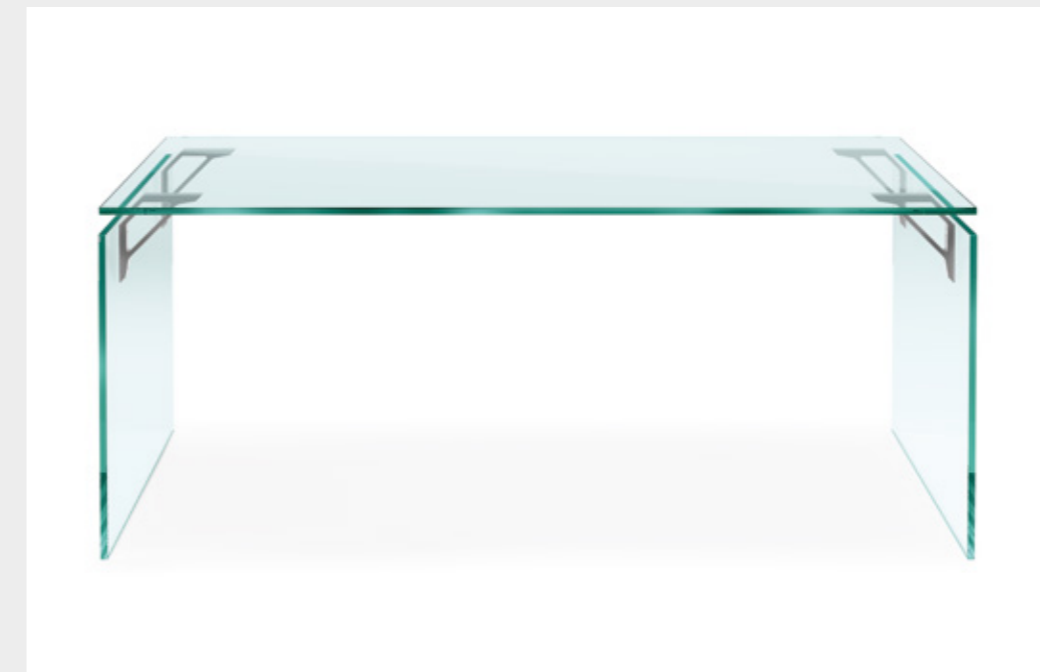

120 x 60 x 73 cm
47 1/4" x 23 5/8" x 28 3/4"
130 x 60 x 73 cm
51 3/16" x 23 5/8" x 28 3/4"
140 x 70 x 73 cm
55 1/8" x 27 9/16" x 28 3/4"
160 x 70 x 73 cm
62" x 27 9/16" x 28 3/4"
180 x 80 x 73 cm
70 7/8" x 31 1/2" x 28 3/4"

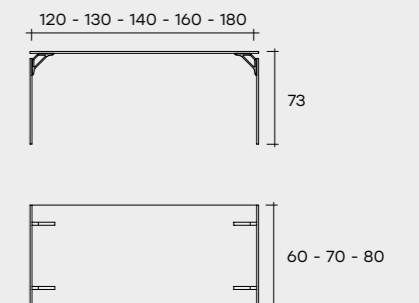

graph

DESIGN
XAVIER LUST



Scrivania composta da base in vetro trasparente curvato da 19 mm e piano in vetro trasparente da 15 mm con piastre di aggancio in acciaio inox.

Desk with base in 19 mm curved transparent glass and 15 mm transparent glass top with stainless steel connecting plates.

Bureau composé d'une base en verre transparent cintré de 19 mm et d'un plateau en verre transparent de 15 mm avec plaques de fixation en acier inoxydable.

Schreibtisch mit Untergestell aus 19 mm starkem, gebogenem, transparentem Glas und 15 mm starker, transparenter Glasplatte mit Befestigungselementen aus Edelstahl.

220 x 80 x 74 cm
86 5/8" x 31 1/2" x 29 1/8"
250 x 91 x 74 cm
90 7/16" x 35 13/16" x 29 1/8"

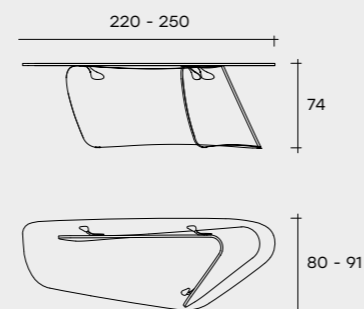

LLT

DESIGN
DANTE O. BENINI
E LUCA GONZO



Scrivania con piano in vetro trasparente da 15 con bisellatura su due lati corti, struttura gambe in vetro trasparente saldato da 15 con bisellatura sul bordo. Particolari di fissaggio in acciaio inox. Disponibile anche con piani su misura.

Desk composed of a 15 thick transparent glass top with bevelled edges on the two shorter sides and of a base in 15 mm thick transparent welded glass with bevelled edge. Fastening elements in stainless steel. Also available with tops of customized size.

Bureau se composant d'un plateau en verre transparent de 15 mm avec biseautage sur les deux côtés courts et d'un piétement en verre transparent soudé, épaisseur 15 mm, avec bords biseautés. Éléments de fixation en acier inoxydable. Également disponible avec plateau sur mesure.

Schreibtisch mit Platte aus transparentem 15 mm starkem Glas, Facettenschliff auf den zwei kürzeren Seiten. Untergestell aus transparentem 15 mm starkem verschweisstem Glas, Facettenschliff auf den Kanten. Verbindungselemente aus Edelstahl. Auch mit Maßgefertigter Platte.



160 x 70 x 72 cm
63" x 27 3/16" x 28 3/8"
180 x 80 x 72 cm
70 7/8" x 31 1/2" x 28 3/8"

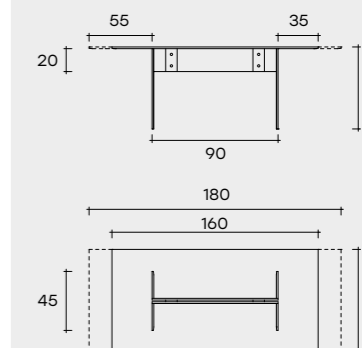

LLT ofx executive

DESIGN
DANTE O. BENINI
E LUCA GONZO



Collezione di scrivanie direzionali in vetro trasparente da 19 mm. Il piano è appoggiato sulle basi in vetro saldato e i fori presenti hanno la funzione di passacavi. LLT ofx executive è disponibile anche con piani su misura, fino ad una lunghezza di 260 cm.

Collection of executive desks in 19 mm thick transparent glass. The top rests on the bases in welded transparent glass and is equipped with cable entry holes. LLT ofx executive is also available with custom-sized top up to 260 cm length.

Collection des bureaux se composant d'un plateau en verre transparent de 19 mm et d'un piétement en verre transparent soudé. Trous pour le passage des cables. Disponible avec plateau sur mesure jusqu'à une longueur de cm 260.

Kollektion von Schreibtischen Besprechungstisch mit Platte aus transparentem 19 mm starkem Glas, und Untergestell aus transparentem 19 mm starkem verschweisstem Glas. Kabelführungslöcher. Auch mit Maßgefertigter Platte erhältlich bis max. Länge von 260 cm.

180 x 90 x 74 cm
70 7/8" x 35 7/16" x 29 1/8"
260 x 90 x 74 cm
102 3/8" x 35 7/16" x 29 1/8"

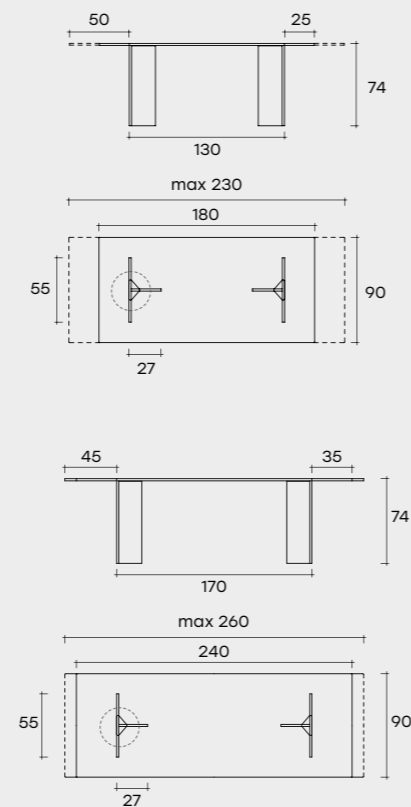

rialto isola

DESIGN
CRS FIAM



Scrivania composta da un ripiano principale e da un ripiano di servizio in vetro trasparente curvato da 15 mm sul lato sinistro. Disponibile anche su misura. Su richiesta: profili in alluminio brillantato.

Desk comprising a main top and a shelf in curved 15 mm transparent glass on the left side. Also available custom-sized. On request: strips in polished aluminium.

Bureau constitué d'un plateau principal et d'un plateau de service en verre transparent cintré de 15 mm. Egalement disponible sur mesure. Sur demande: profiles en aluminium brillanté.

Schreibtisch mit Querplatte aus 15 mm starkem, gebogenem, transparentem Glas. Auch Maßanfertigungen lieferbar. Auf Wunsch: geätzte Aluminiumprofile.

Piano principale / Main top:
170 x 70 x 73 cm
67" x 27 9/16" x 28 3/4"
Piano di servizio / Side shelf:
140 x 50 x 60 cm
55 1/8" x 19 11/16" x 23 5/8"

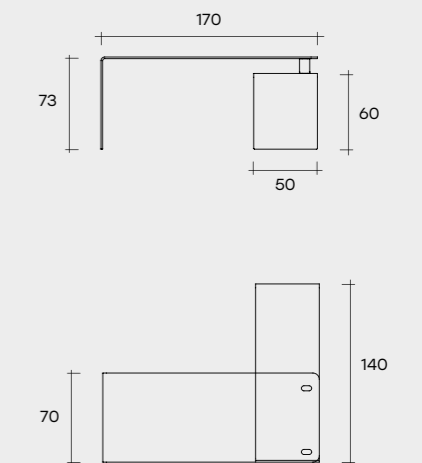

rialto L

DESIGN
CRS FIANI



Scrivania in vetro curvato da 15 mm, abbinata a cassetteria in legno laccato opaco nei colori bianco o nero con frontali in vetro verniciati in abbinamento al colore della struttura. Disponibile anche su misura.

Desk in 15 mm curved glass combined with drawer unit in white or black matt lacquered wood, with fronts in glass varnished to match the structure colour. Also available custom-sized.

Bureau en verre cintré de 15 mm, avec meuble à tiroirs en bois laqué opaque dans les coloris blanc ou noir avec façades en verre vernies de couleur assortie à la structure. Egalement disponible sur mesure.

Schreibtisch aus 15 mm starkem gebogenem Glas, kombiniert mit Schubladenelement aus matt lackiertem Holz in Weiß oder Schwarz mit Fronten aus farblich zum Korpus passend lackiertem Glas. Auch als Maßanfertigung lieferbar.

120 x 60 x 73 cm
47 1/4" x 23 5/8" x 28 3/4"

140 x 70 x 73 cm
55 1/8" x 27 9/16" x 28 3/4"

160 x 70 x 73 cm
63" x 27 9/16" x 28 3/4"

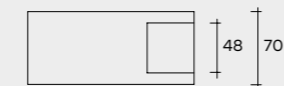
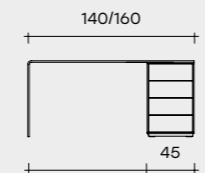
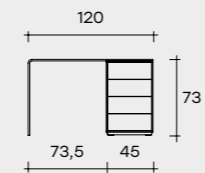

rialto L wall mounted

DESIGN
CRS FIANI



Scrivania a parete in vetro curvato da 15 mm, abbinata ad una doppia piastra in alluminio brillantato per fissaggio a parete. Disponibile anche su misura (dimensione minima 90 x 60 x 73 cm, dimensione massima 210 x 100 x 73 cm).

Wall-mounted desk in 15 mm curved glass combined with a double polished aluminium plate for wall-mounting. Also available custom-sized (min. size: 90 x 60 x 73 cm, max. size: 210 x 100 x 73 cm).

Bureau murale en verre cintré de 15 mm, assorti à une double plaque en aluminium poli pour fixation murale. Egalement disponible sur mesure (dimensions minimales: 90 x 60 x 73 cm, dimensions maximales: 210 x 100 x 73 cm).

Schreibtisch an Wand aus 15 mm starkem, gebogenem Glas, kombiniert mit einer doppelten Leiste aus poliertem Aluminium zur Befestigung an der Wand. Auch als Maßanfertigung lieferbar (mind. 90 x 60 x 73 cm - max. 210 x 100 x 73 cm).

120 x 60 x 73 cm
47 1/4" x 23 5/8" x 28 3/4"

140 x 70 x 73 cm
55 1/8" x 27 9/16" x 28 3/4"

160 x 70 x 73 cm
63" x 27 9/16" x 28 3/4"

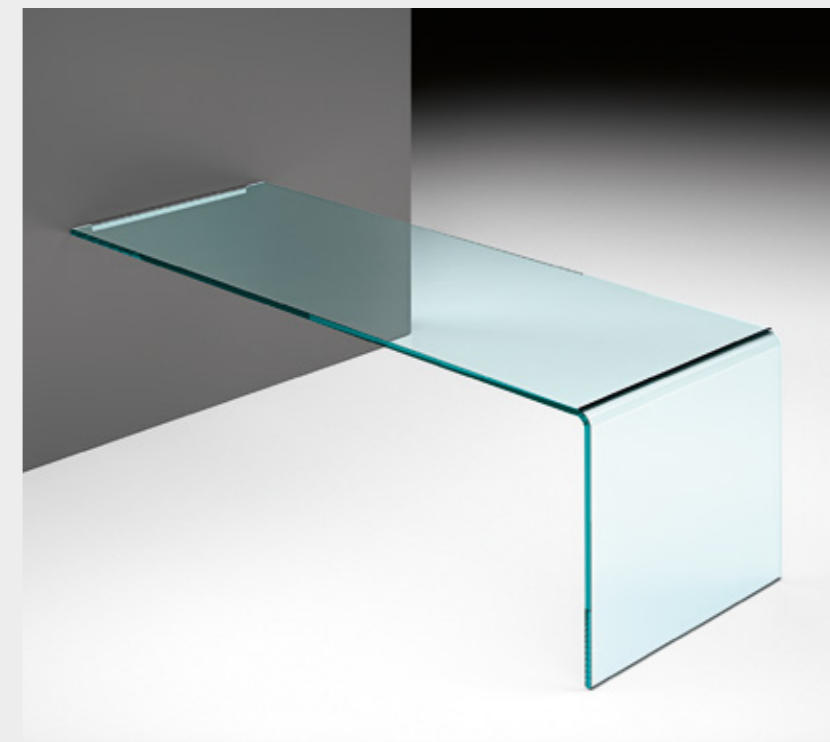
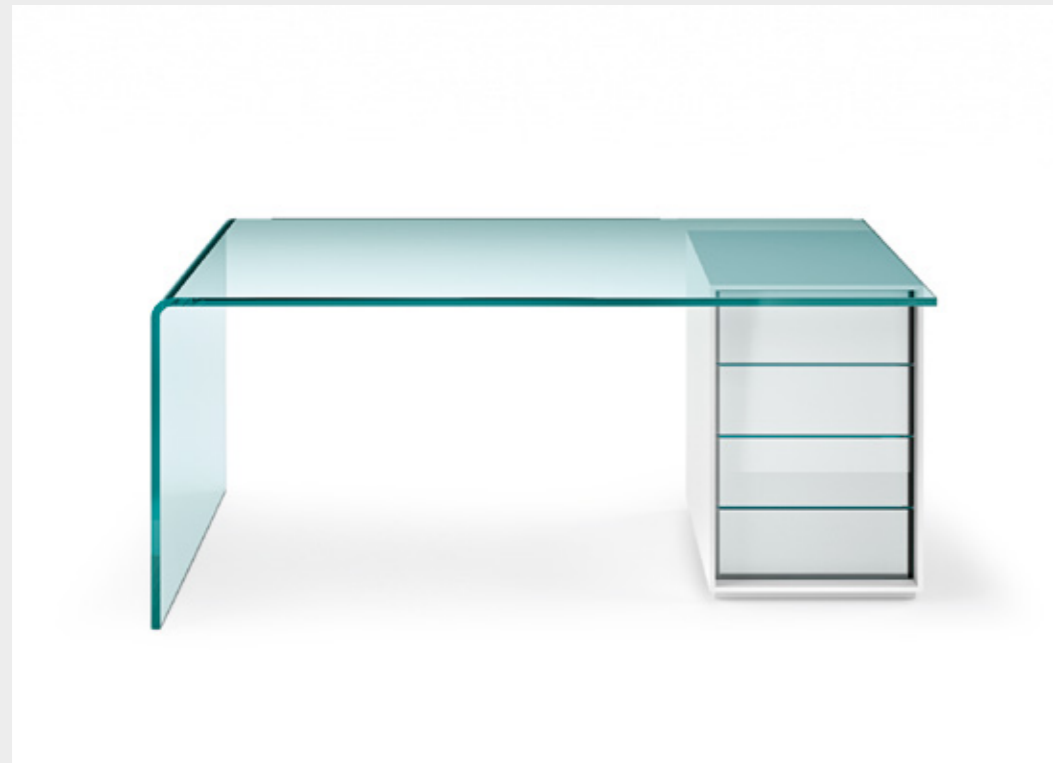
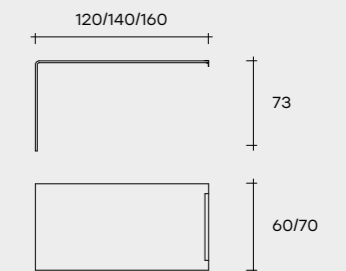

rialto scrivania

DESIGN
CRS FIAM



Collezione di scrivanie in vetro curvato da 15 mm disponibili in varie misure. Su richiesta: profili in alluminio brillantato. Disponibile anche su misura.

Collection of desks in 15 mm curved glass, available in various sizes. On request: strips in polished aluminium. Also available custom-sized.

Collection de bureaux en verre cintré de 15 mm disponibles dans plusieurs dimensions. Sur demande: profils en aluminium brillanté. Egalement disponible sur mesure.

Kollektion von Schreibtischen aus 15 mm starkem gebogenem Glas in diversen Abmessungen. Auf Wunsch: geglänzte Aluminiumprofile. Auch als Maßanfertigung lieferbar.

100 x 60 x 73 cm
39 3/8" x 23 5/8" x 28 3/4"
120 x 60 x 73 cm
47 1/4" x 23 5/8" x 28 3/4"
140 x 70 x 73 cm
55 1/8" x 27 9/16" x 28 3/4"
160 x 70 x 73 cm
63" x 27 9/16" x 28 3/4"
160 x 80 x 73 cm
63" x 31 1/2" x 28 3/4"

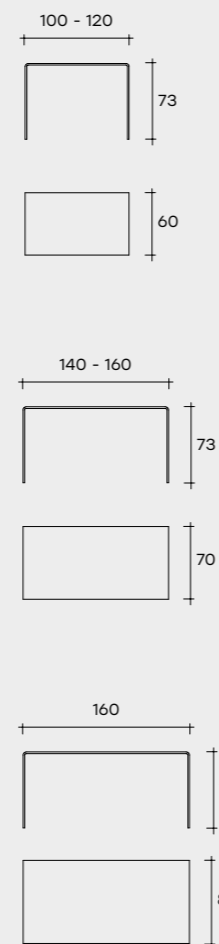
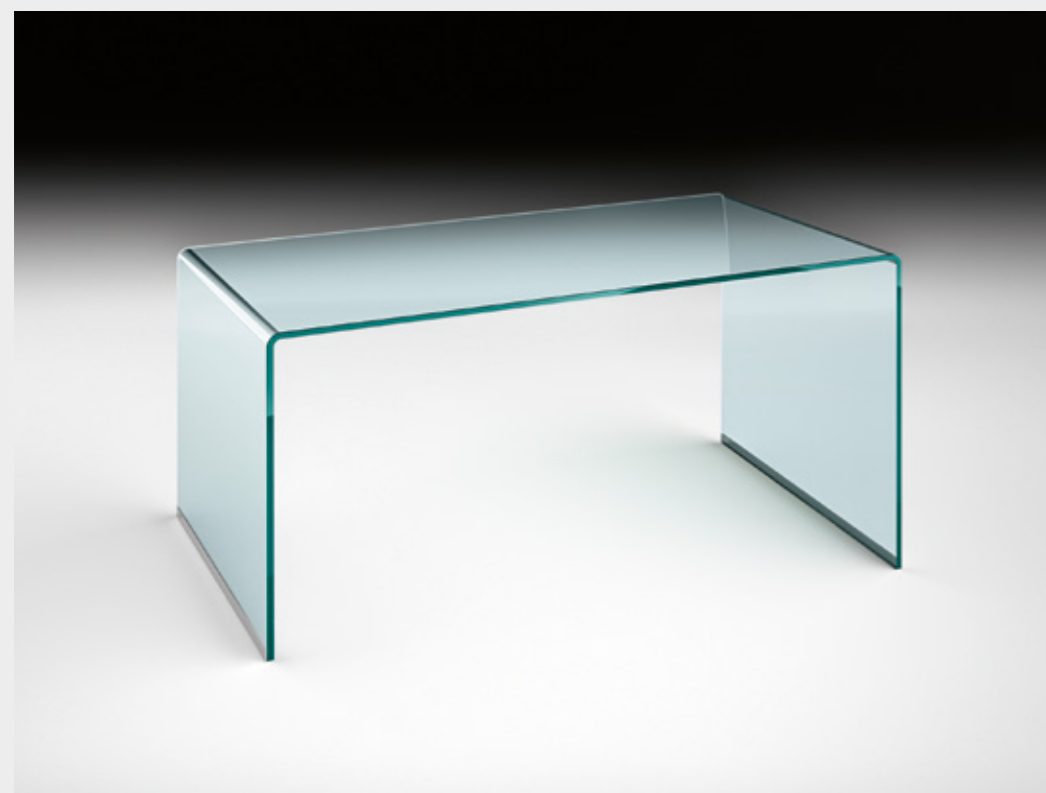

scribe

DESIGN
DANIEL LIBESKIND

Scrivania composta da due basi in vetro curvato da 12 mm retroargentato e piano in vetro da 12 mm, con porzioni retroargentate. La scrivania prevede una serie a tiratura limitata: 40 pezzi unici numerati per celebrare il 40° Anniversario Fiam.

Desk composed of two 12 mm curved silvered glass bases and a glass top 12 mm thick, with silvered parts. In limited edition: 40 numbered pieces celebrating Fiam 40th Anniversary.

Bureau constitué de deux bases en verre miroité de 12 mm et d'un plateau en verre de 12 mm avec parties miroitées. Prévus une édition limitée: 40 pièces numérotées pour célébrer le 40e anniversaire Fiam.

Schreibtisch mit zwei Basis aus 12 mm verspiegeltem Glas und einer Platte aus 12 mm Glas mit verspiegelten Teilen. In limitierter Auflage: 40 nummerierte Exemplare, zum 40. Jahrestag Fiam.

180 x 75 x 73 cm
70 7/8" x 29 1/2" x 28 3/4"

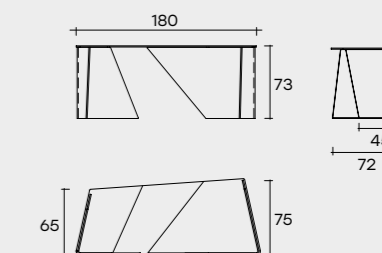

LLT ofx meeting

DESIGN
DANTE O. BENINI
E LUCA GONZO



Tavolo riunioni in vetro trasparente da 19 mm. Il piano è appoggiato sulle basi in vetro saldato e i fori presenti hanno la funzione di passacavi. LLT ofx meeting è disponibile anche con piani su misura, fino ad una dimensione massima 350x120 cm.

Meeting table in 19 mm thick transparent glass. The top rests on the bases in welded transparent glass and is equipped with cable entry holes. LLT ofx meeting is also available with custom-sized top up to 350x120 cm.

Table de réunion se composant d'un plateau en verre transparent de 19 mm et d'un piétement en verre transparent soudé avec des trous pour le passage des cables. Disponible avec plateau sur mesure jusqu'à 350x120 cm.

Besprechungstisch mit Platte aus transparentem 19 mm starkem Glas, und Untergestell aus transparentem 19 mm starkem verschweisstem Glas. Kabelführungslöcher. Auch mit maßgefertigter Platte erhältlich bis max. 350x120 cm.

350 x 120 x 74 cm
137 13/16" x 47 1/4" x 29 1/8"

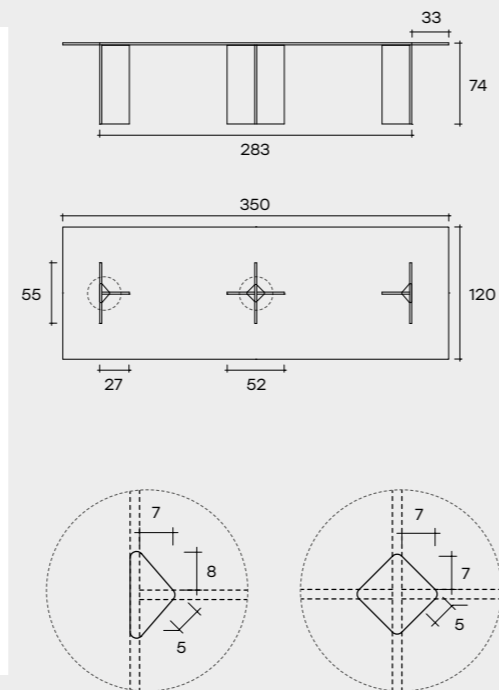

luxor

DESIGN
RODOLFO DORDONI



Tavolo con piano in vetro fumé o bronzo stratificato da 8+8 mm finitura filo lucido tondo, disponibile anche in vetro trasparente o extralight da 12 e da 15 mm. A seconda della misura e della configurazione desiderata base composta da 2, 3 o 4 cilindri (Ø 40 cm) in vetro da 10 mm, fumé, bronzo, NERO 95, trasparente o extralight, extralight retroverniciato bianco o retroargentato verniciato bianco. È possibile realizzare il piano su misura.

Table with a 8 mm + 8 mm laminated smoked or bronze glass top, shiny polished edge, also available in transparent glass or extralight glass (12 or 15 mm thick). 10 mm-thick curved glass bases, composed of 2, 3 or 4 cylinders (Ø 40 cm) depending on the size and the shape requested. The glass bases available in the following finishings: transparent, extralight, extralight white back-stained or extralight back-silvered white stained, Black 95 (NERO 95), smoked or bronze. It is possible to order custom-sized tops.

Table avec plateau en verre feuilleté de 8+8 mm fumé ou bronze, finition bord poli arrondi, disponible aussi en verre transparent ou extralight de 12 ou 15 mm. Selon la mesure ou la configuration choisie, base composée par 2, 3 ou 4 cylindres (Ø 40 cm) en verre de 10 mm, fumé, bronze, Noir 95 (NERO 95), transparent ou extralight, extralight verni dessous blanc, extralight argenté verni dessous blanc. Plateau disponible aussi en version sur mesure.

Tisch mit 8+8 mm-starker Schichtglasplatte in Rauch- oder Bronze-Glas oder in transparentem bzw. extralight Glas, 12 oder 15 mm Stärke. Untergestell bestehend aus 2, 3 bzw. 4 Glas-Zylindern (Durchmesser 40 cm) abhängig von den gewünschten Massen und Gestaltung, 10 mm Glasstärke. Lieferbar in den folgenden Ausführungen: Rauch- oder Bronzeglas, Schwarz 95 (NERO 95)-Glas, transparentes bzw. extralight-Glas, weiss lackiertes extralight-Glas oder extraligh-Glas versilbert mit Weiß Lackierung. Die Tischplatte kann nach Maß bestellt werden.

150 x 150 x 75 cm
59 1/16" x 59 1/16" x 29 1/2"
220 x 110 x 75 cm
86 5/8" x 43 5/16" x 29 1/2"
240 x 120 x 75 cm
94 1/2" x 47 1/4" x 29 1/2"

Dimensioni custom
Custom dimensions
Dimensions custom
Custom Abmessungen

350 x 120 x 74 cm
137 13/16" x 47 1/4" x 29 1/8"

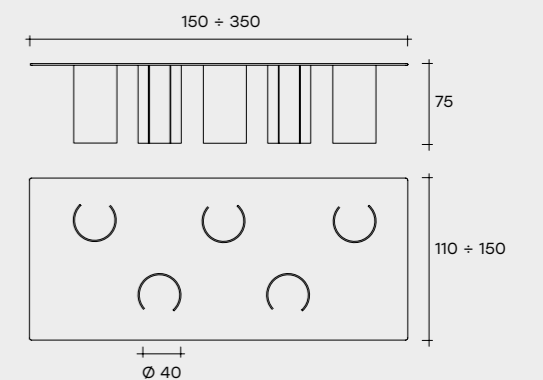

inori

DESIGN
SETSU E SHINOBU ITO



Sistema composto da elementi in vetro o legno modulari. La modularità e versatilità ne permette l'utilizzo come libreria, espositore, contenitore, porta Tv.

System consisting of modular glass or wood elements. Its modularity and versatility allow it to be used as a bookcase, display case, storage unit or TV unit.

Système composé d'éléments modulaires en verre ou bois. Sa modularité et sa polyvalence permettent de l'utiliser comme une bibliothèque, un présentoir, un meuble de rangement, un meuble TV.

System aus modularen Glas-oder Holz-Elementen. Vielseitig einsetzbar und beliebig kombinierbar, als Bücherregal, Ausstellungsregal, TV-Element usw.

inori freestanding

DESIGN
SETSU E SHINOBU ITO



Il sistema Inori Freestanding si sviluppa in situazioni autoportanti: nelle versioni in vetro e nella misura larga 240 cm, da altezza minima 35 cm sino all'altezza massima 180 cm, il sistema prevede delle barre di irrigidimento in alluminio anodizzato nero.

The system Inori offers free-standing solutions: in glass versions and in width 240 cm, from a height of minimum 135 cm up to the maximum height of 180 cm, the system is complete with black anodised aluminium reinforcement bars.

Le système Inori se présente dans des solutions autoportantes: dans les versions en verre et dans la largeur de 240 cm, d'une hauteur minimale de 135 cm jusqu'à une hauteur maximale de 180 cm, le système est doté de barres d'armature en aluminium anodisé noir.

Das System Inori entwickelt sich als freistehender Raumteiler: in Glasausführung Breite 240 cm, Höhe mindestens 135 cm, maximal 180 cm, mit Verstärkungen aus Schwarz eloxiertem Aluminium.

240 x 36,5 x 180 cm
94 1/2" x 14 3/8" x 70 7/8"

(H max 180 cm)
Con accessorio dedicato
With reinforcement bars



inori

DESIGN
SETSU E SHINOBU ITO



Tutti i montanti sono liberamente posizionabili tramite sistema di ancoraggio e scorrimento a binario applicato su ogni singolo ripiano. Binario in alluminio anodizzato nero.

The uprights are freely adjustable on each shelf through sliding rails and fixing device. Slides in anodized black aluminum.

Tous montants sont positionnables avec un système de fixation et rail appliqué sur chaque étagère. Rail en aluminium anodisé noir.

Die Stützen sind frei verstellbar auf jedem Fachboden durch Führung und Befestigungsmodul. Laufschiene aus schwarzem eloxiertem Aluminium.



Ripiani in legno
spessore 40 mm
Wooden shelves
40 mm thick
Étagères en bois,
épaisseur 40 mm
Holzfachböden,
40 mm Stärke

(L 180/240)

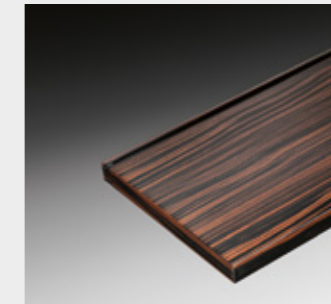

Ebano laccato lucido
Glossy lacquered ebony
Ebène laquée brillante
Glänzlackiertes Ebenholz

Montanti in vetro curvato
da 10 mm
Uprights in curved glass,
10 mm thick
Montants en verre cintré
de 10 mm
Stütze aus gebogenem
Glas, 10 mm



Montanti: h 32 cm o h 42 cm
Uprights: h 32 cm or h 42 cm
Montants: h 32 cm ou h 42 cm
Stütze: H 32 cm oder H 42 cm



Extralight _ Extralight
Extralight _ Extralight



Trasparente _ Transparent
Transparent _ Transparent



Nero95 _ Black95
Noir95 _ Schwarz95

Base d'appoggio
in vetro temperato,
spessore 12 mm
Base in tempered glass,
12 mm thick
Base en verre trempé
de 12 mm
Basis aus gehärtetem
12 mm starkem Glas

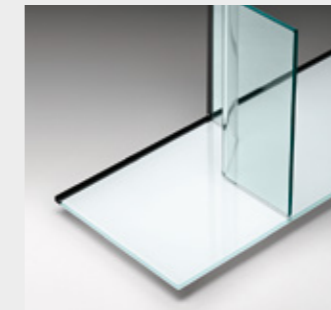

Extralight retro-verniciato bianco
Extralight white back-stained
Extralight verni dessous blanc
Extralight mit weisser Hinterlackierung

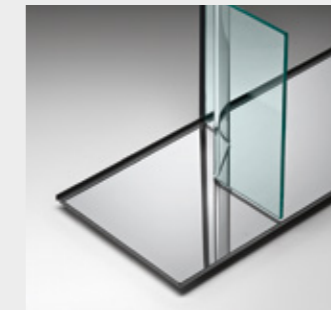

Extralight retro-argentato
Extralight back-mirrored
Extralight argenté dessous
Extralight mit Hinterverspiegelung

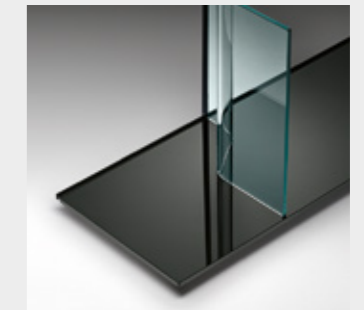

Fumé retro-verniciato nero
Smoked glass black back-stained
Fumé verni dessous noir
Rauchglas mit schwarzer
Hinterlackierung

Ripiani in vetro temperato,
spessore 12 mm
Shelves in tempered glass,
12 mm thick
Étagères en verre trempé
de 12 mm
Fachböden aus gehärtetem
12 mm starkem Glas

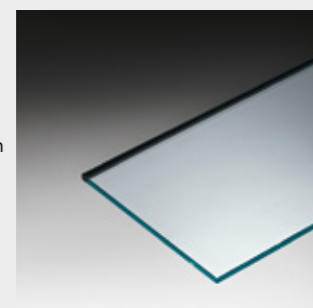

Extralight _ Extralight
Extralight _ Extralight

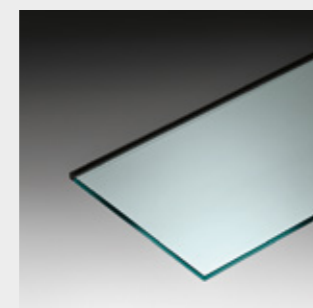

Trasparente _ Transparent
Transparent _ Transparent

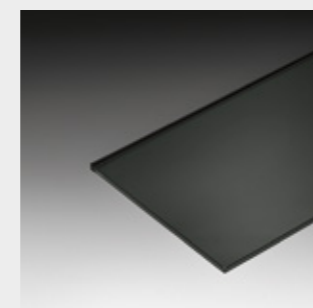

Fumé _ Smoked
Fumé _ Rauchglas

Base d'appoggio in legno
spessore 40 mm
Wooden base,
40 mm thick
Base en bois,
épaisseur 40 mm
Holzbasis,
40 mm Stärke

(L 180/240)

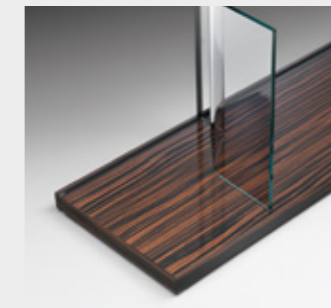

Ebano laccato lucido
Glossy lacquered ebony
Ebène laquée brillante
Glänzlackiertes Ebenholz



Basi _ Dimensioni
Bases _ Sizes
Bases _ Dimensions
Basis _ Maße

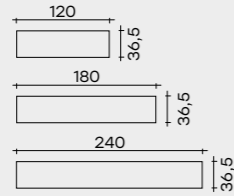

Ripiani _ Dimensioni
Shelves _ Sizes
Étagères _ Dimensions
Fachböden _ Maße

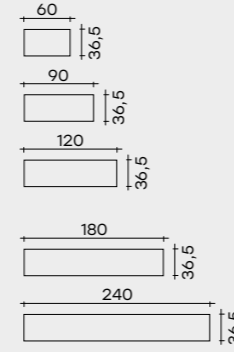

Disponibili solo nelle finiture vetro
In glass versions only
Pour les étagères en verre uniquement
Für die Glasfachböden nur

Disponibili in tutte le finiture
In all finishings
Pour toutes finitions
Für alle Finish

Montanti / Uprights
Montants / Stütze

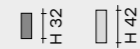

Alcuni suggerimenti tra le infinite soluzioni _ Just a few of the numerous solutions
Quelques suggestions parmi de nombreuses possibilités _ Einige Vorschläge zu unzähligen Lösungen

Libreria _ Bookcase _ Bibliothèque _ Bücherregal

Montanti / Uprights
Montants / Stütze

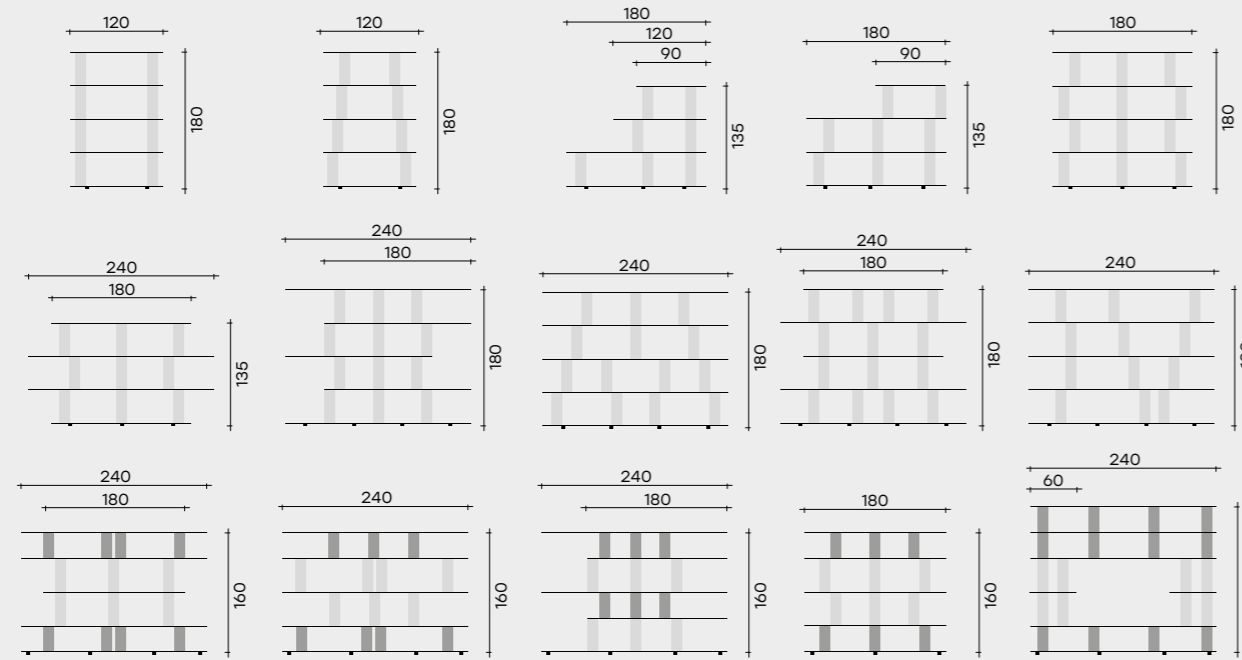
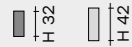

Porta TV _ Tv unit _ Porte-TV _ TV-Ständer

Montanti / Uprights
Montants / Stütze

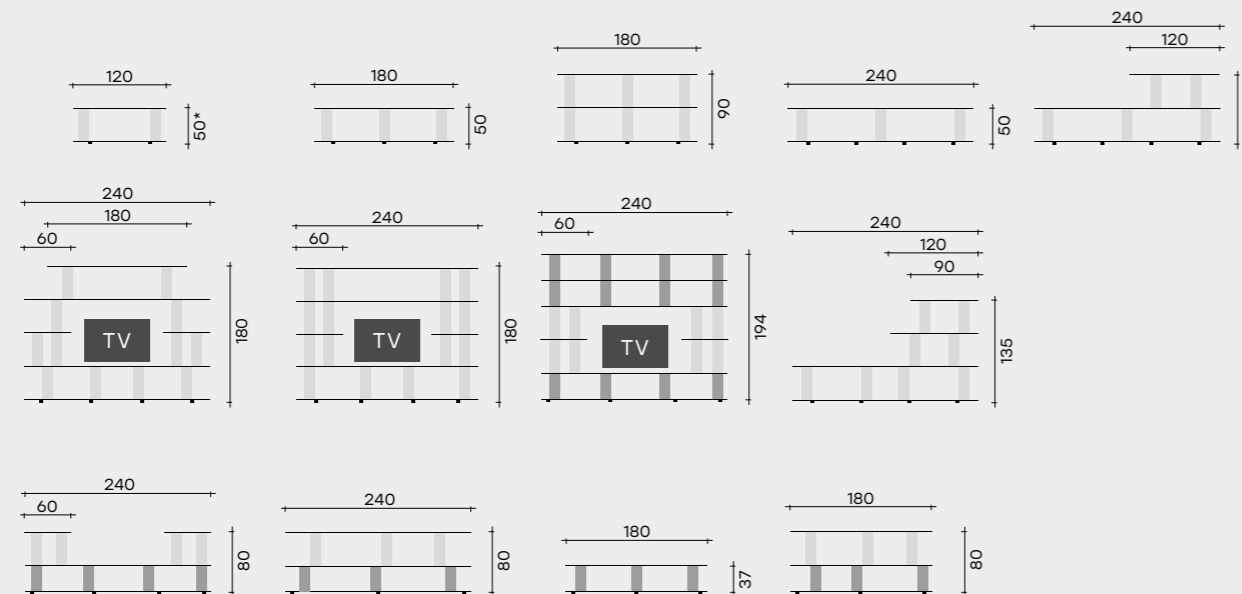
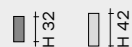

Consolle _ Console _ Console _ Konsole

Montanti / Uprights
Montants / Stütze

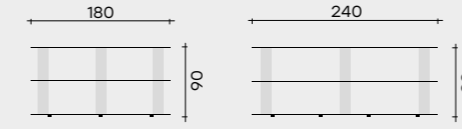

Retro divano _ Sofa back sideboard _ Bout de Canape _ Sofa Hinterelement

Montanti / Uprights
Montants / Stütze

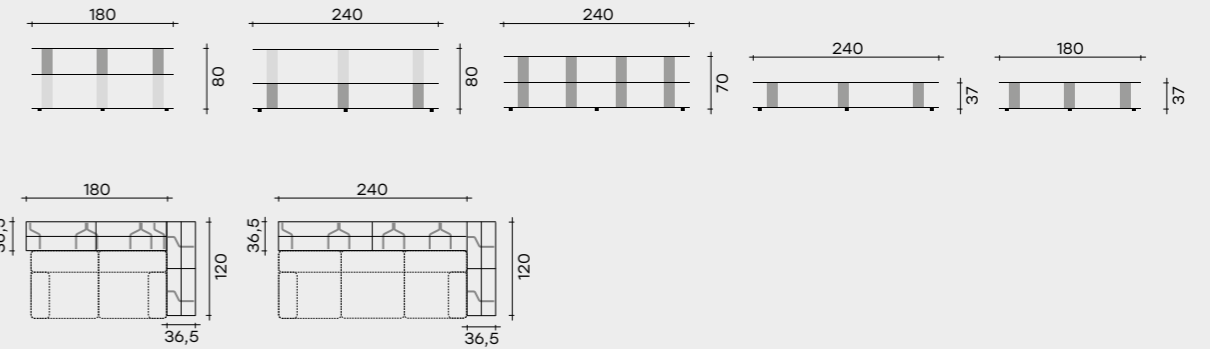

Mobile basso _ Low unit _ Meubles bas _ Kleinmöbel

Montanti / Uprights
Montants / Stütze

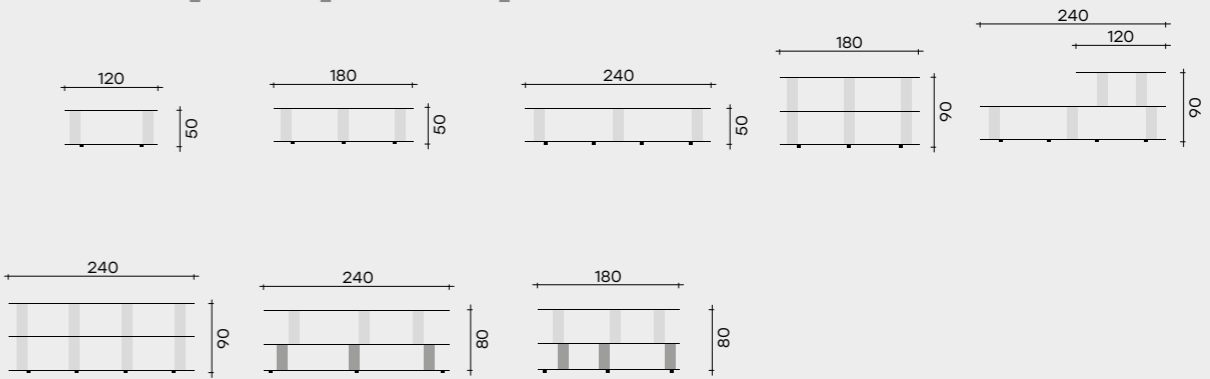

Soluzione centrostanza _ Room centrepiece solution _ Solution en séparation de pièces _ Zimmermitte-Lösung

Montanti / Uprights
Montants / Stütze

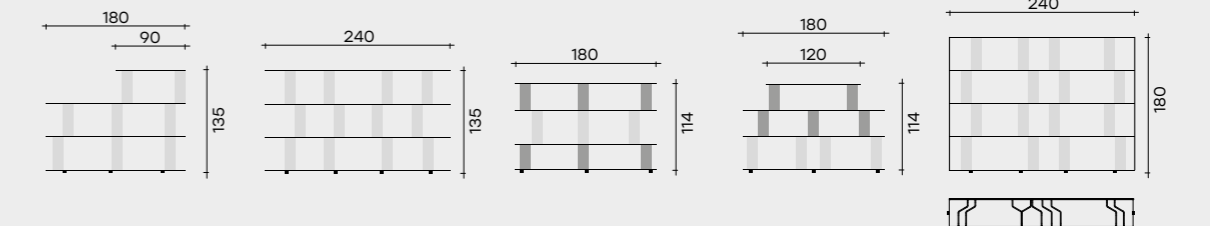

Altezza massima per le strutture autoportanti:

- Su basi di lunghezza 240, solo versioni in vetro e con barre di irrigidimento: h max 180 cm.
- Su basi di lunghezza 180 / 240 cm senza barre di irrigidimento: h max 135 cm.
- Su basi di lunghezza 120 cm senza barre di irrigidimento: h max 50 cm.

Altezza massima per le strutture con ancoraggio a muro:

- massimo 5 ripiani ed altezza totale massima 234 cm. (equivalente a 3 montanti h 32 cm abbinati a 2 montanti h 42)

Distanza massima tra i montanti: 130 cm.

Max. height of the free-standing version:

- Glass versions width 240 cm with reinforcement bars: maximum height 180 cm.
- With base length 180 / 240 cm without reinforcement bars: h max 135 cm.
- With base length 120 cm without reinforcement bars: h max 50 cm.

Max. height of the wall version:

- max. 5 shelves - total height 234 cm. (i.e. 3 uprights in height 32 cm and 2 uprights height 42 cm)

Max. distance between the uprights: 130 cm.

Hauteur maxi. pour les structures posées au sol:

- Avec base de longueur 240 cm dans les versions en verre et avec barres d'armature: h max 180 cm.
- Avec base de longueur 180 / 240 cm sans barres d'armature: h max 135 cm.
- Avec base de longueur 120 cm sans barres d'armature: h max 50 cm.

Hauteur maxi. pour les structures accrochables au mur:

- Avec max.5 étagères - hauteur totale 234 cm. (c.à.d. 3 montants hauteur 32 cm et 2 montants hauteur 42 cm)

Distance maxi entre les montants: 130 cm.

Max. Höhe der Standausführung:

- Mit Basislänge 240 cm Glasversion mit Verstärkungen: H max 180 cm.
- Mit Basislänge 180 / 240 cm ohne Verstärkungen: H max 135 cm.
- Mit Basislänge 120 cm ohne Verstärkungen: H max 50 cm.

Max.Höhe der Wandausführung:

- Mit max. 5 Fachböden - Gesamthöhe 234 cm (gleich mit 3 Stützen 32 cm hoch und 2 Stützen 42 cm hoch)

Max. Abstand zwischen den Stützen: 130 cm.

luminare cassettiera

DESIGN
CRS FIAM

Cassettiera in legno laccato opaco nei colori bianco o nero. Disponibile con 3 o 4 cassetti. I frontali sono in vetro da 6 mm verniciati in abbinamento al colore della struttura. Disponibile anche con ruote piroettanti.

Drawer unit in white or black matt lacquered wood. Available with 3 or 4 drawers. The fronts are in 6 mm glass varnished to match the carcass colour. Also available with castors.

Meuble à tiroirs en bois laqué opaque dans les coloris blanc ou noir. Disponible avec 3 ou 4 tiroirs. Les façades sont en verre de 6 mm et peintes dans la même teinte que la structure. Egalement disponible avec des roulettes pivotantes.

Schubladenelement aus matt lackiertem Holz in Weiß oder Schwarz, mit 3 oder 4 Schubladen. Fronten aus 6 mm starkem, lackiertem Glas in der Korpusfarbe. Auch mit Lenkrollen.

45 x 48 x 54 cm
17 11/16" x 18 7/8" x 21 1/4"
45 x 48 x 57 cm
17 11/16" x 18 7/8" x 22 7/16"
con ruote, with castors
avec roulettes, mit Lenkrollen
45 x 48 x 70 cm
17 11/16" x 18 7/8" x 27 9/16"
45 x 48 x 73 cm
17 11/16" x 18 7/8" x 28 3/4"
con ruote, with castors
avec roulettes, mit Lenkrollen

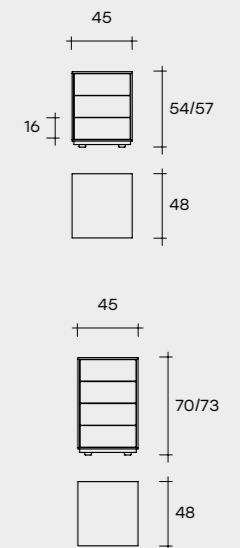

mensole rialto L

DESIGN
CRS FIAM



Mensole in vetro curvato da 10 mm. Reggimensola in metallo cromato. Le mensole sono disponibili anche su misura con i seguenti limiti: lunghezza: da 65 cm a 190 cm; profondità: da 24 cm a 30 cm; altezza: fino a 36 cm per lunghezze entro i 100 cm e fino a 70 cm per lunghezze oltre i 100 cm. L'interasse massimo tra i reggimensola è di 70 cm.

Shelves in 10 mm curved glass. Chromed metal brackets. The shelves are also available custom-sized with the following limits: length: from 65 cm to 190 cm; depth: from 24 cm to 30 cm; height: up to 36 cm for lengths up to 100 cm and up to 70 cm for lengths over 100 cm. The maximum gap between brackets is 70 cm.

Etagères en verre cintré de 10 mm Supports d'étagère en métal chromé. Les étagères sont également disponibles sur mesure avec les limites suivantes : longueur: de 65 cm à 190 cm, profondeur : de 24 cm à 30 cm, hauteur : jusqu'à 36 cm pour les longueurs inférieures à 100 cm et jusqu'à 70 cm pour les longueurs supérieures à 100 cm. La distance maximale entre les supports d'étagère est de 70 cm.

Konsole aus 10 mm starkem, gebogenem Glas. Konsolehalterungen aus verchromtem Metall. Auch maßgefertigt lieferbar in Längen von 65 bis 190 cm, Tiefen von 24 bis 30 cm, Höhen bis 36 cm für Längen bis 100 cm, Höhen bis 70 cm für Längen über 100 cm. Maximaler Mittenabstand zwischen den Halterungen 070 cm.

190 x 30 x 40 cm
74 13/16" x 11 13/16" x 15 3/4"

140 x 24 x 40 cm
55 1/8" x 9 7/16" x 15 3/4"

100 x 24 x 36 cm
39 3/8" x 9 7/16" x 14 3/16"

65 x 24 x 30 cm
25 9/16" x 9 7/16" x 11 13/16"

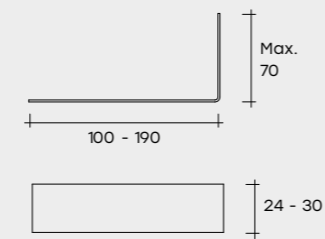
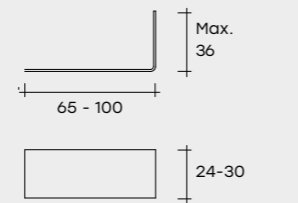

Possibili composizioni
Possible compositions
Compositions possibles
Mögliche Zusammensetzungen

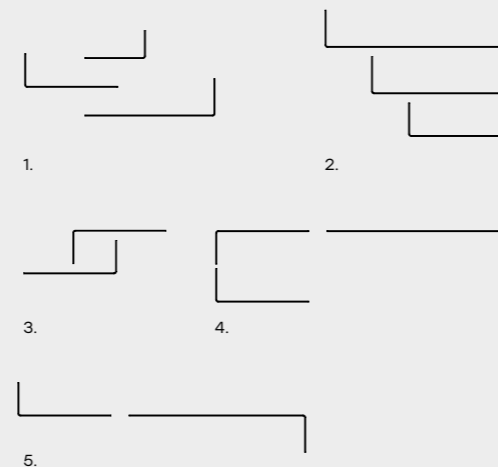

rialto cassetiera

DESIGN
CRS FIAM

Cassetiera in vetro curvato trasparente da 8 mm. La struttura dei cassetti è in legno laccato bianco. La cassetiera è provvista di 2 cassetti con sistema di chiusura automatica soft. Ruote e maniglie cromate.

Drawer unit in 8 mm curved transparent glass. The drawers have white lacquered wood frame. The drawer unit features 2 drawers with automatic soft closure system. Chromed wheels and handles.

Meuble à tiroirs en verre cintré transparent de 8 mm. La structure des tiroirs est en bois laqué blanc. Le meuble à tiroirs est doté de 2 tiroirs avec système de fermeture automatique amortie. Roulettes et poignées chromées.

Kommode aus 8 mm starkem, transparentem, gebogenem Glas. Zargen der Schubladen aus weiß lackiertem Holz. 2 Schubladen mit automatischen Soft-Close-Einzug. Räder und Griffe verchromt.

48 x 45 x 67 cm
18 7/8" x 17 11/16" x 26 3/8"

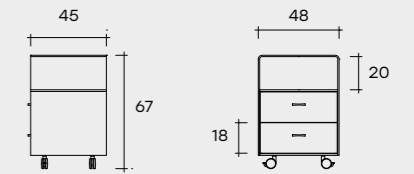

SPECCHI 112
MIRRORS

TAVOLI 128
MULTIMATERICI
MULTIMATERIAL
TABLES

120
VETRINE,
ESPOSITORI,
MENSOLE
SHOWCASE,
DISPLAY UNIT,
SHELVES

129
TAVOLI
ALLUNGABILI
EXTENSIBLE
TABLES

121
SISTEMI,
CONTENITORI
COMPONIBILI
SYSTEMS,
CONTAINER
CABINETS

134
TAVOLI BASSI
COFFEE TABLES

134
CONSOLLE
CONSOLES

128
TAVOLI
TABLES

135
TAVOLI
DI SERVIZIO
SIDE-TABLES

140
HOME OFFICE

CUSTOM MADE & CONTRACT



I Customizzabili

The Customizables
Les personnalisables
Die Anpassbaren

SPECCHI

MIRRORS
MIROIRS
SPIEGEL



	CAADRE	CAADRE TV	CALDEIRA	CHRISTINE	DORIAN	HASAMI	HIROSHI	LUCY	MARY
Misure H. - L. Dimensions H. - L.	•	•							
Finiture vetro Glass finish	•	•	•	•	•	•	•	•	•
Laccatura Laquering	•	•	•	•	•			•	•



	MIRAGE	MIRAGE TV	PHANTOM	REVERSO	RITRATTO	ROSY	THE WING	VENUS
Misure H. - L. Dimensions H. - L.	•	•						
Finiture vetro Glass finish	•		•	•	•	•	•	•
Laccatura Laquering			•		•	•	•	•

caadre

DESIGN
PHILIPPE STARCK

Caadre di Philippe Stark oggi diventa anche un elegante e insolito sistema modulare. Esempio di semplicità e di stile, è in grado di assumere l'identità di specchiera, diventando particolare distintivo di una parete o di moltiplicarsi e combinarsi a piacere, per costituire la parete stessa.

Caadre by Philippe Stark can now also become an elegant, unusual modular system. The utmost in stylish simplicity, it is able to assume the identity of a mirror to form the keynote of a wall, or multiply and combine exactly as required to create the wall itself.

Caadre de Philippe Stark devient maintenant aussi un système modulaire élégant et inhabituel. Exemple de simplicité et de style, il est en mesure d'assumer l'identité de miroir, devenant particulièrement distinctif d'un mur ou de se multiplier et combiner à volonté, pour constituer le mur lui-même.

Caadre von Philippe Stark wird nun auch ein elegantes und ungewöhnliches Modulsystem. Beispiel von Simplizität und Stil ist er in der Lage, die Identität des Spiegels zu nehmen, als kennzeichnendes Element einer Wand oder erweitert er sich und nach Wunsch kombiniert, die Wand selbst wird.

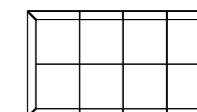

Dimensioni standard Standard dimensions Dimensions standards Standard Abmessungen

105 x 13 x 195 cm
41 5/16" x 5 1/8" x 76 3/4"
76 x 13 x 195 cm
29 15/16" x 5 1/8" x 76 3/4"
195 x 13 x 195 cm
76 3/4" x 5 1/8" x 76 3/4"
140 x 13 x 195 cm
55 1/8" x 5 1/8" x 76 3/4"
105 x 13 x 155 cm
41 5/16" x 5 1/8" x 61"
76 x 13 x 155 cm
29 15/16" x 5 1/8" x 61"
140 x 13 x 140 cm
55 1/8" x 5 1/8" x 55 1/8"
105 x 13 x 105 cm
41 5/16" x 5 1/8" x 41 5/16"
155 x 13 x 240 cm
61" x 5 1/8" x 94 1/2"

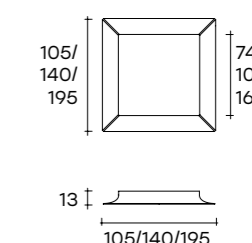
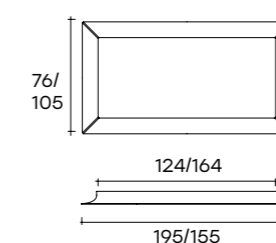
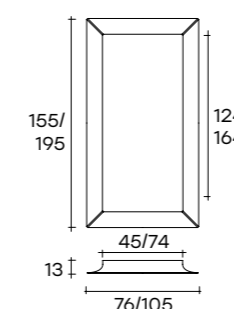
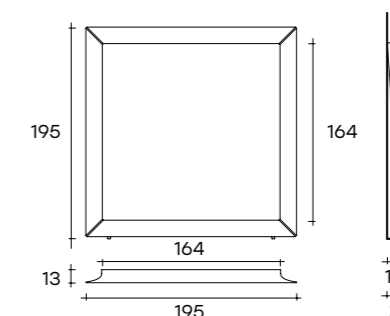
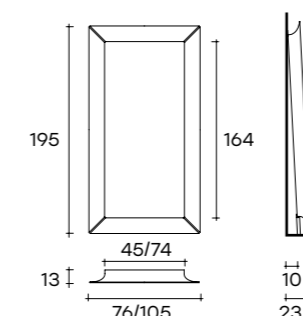

Esempi fra le innumerevoli soluzioni custom _ Examples among the many custom solutions
 Exemples parmi les nombreuses solutions sur demande _ Beispiele unter den vielen Lösungen



Negozió _ Shop
 Magasin _ Geschäft L. P. H. _ L. W. H.
 467 x 13 x 358 cm

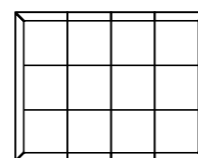

Moduli disponibili _ Available modules
 Modules disponibles _ Verfügbaren Elemente

L. P. H. _ L. W. H.

Mod. A
 min. 124,5 x 13 x 124,5 cm
 max. 169,5 x 13 x 169,5 cm
Larghezza fissa aletta
Frame width
 15,5 cm

Mod. B
 min. 124,5 x 13 x 109 cm
 max. 169,5 x 13 x 164 cm

Mod. C
 min. 109 x 13 x 109 cm
 max. 164 x 13 x 164 cm

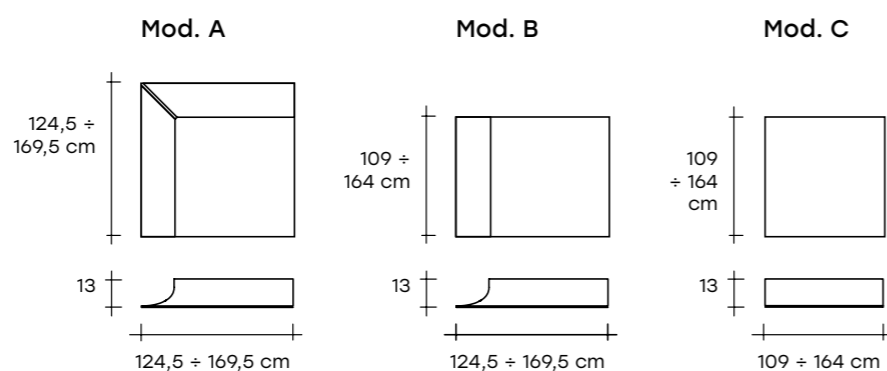
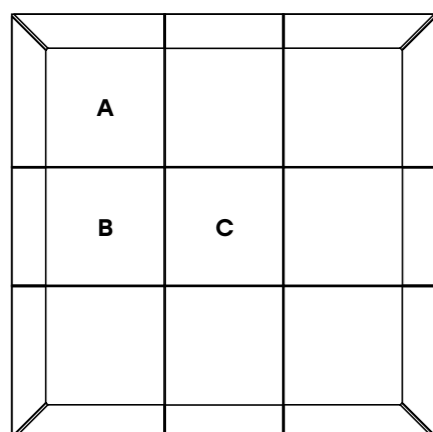

Appartamento _ Apartment
 Appartement _ Wohnung L. P. H. _ L. W. H.
 253 x 13 x 195 cm

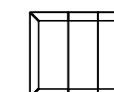

Moduli disponibili _ Available modules
 Modules disponibles _ Verfügbaren Elemente

L. P. H. _ L. W. H.

Mod. D
 min. 124,5 x 13 x 140 cm
 max. 169,5 x 13 x 195 cm
Larghezza fissa aletta
Frame width
 15,5 cm

Mod. E
 min. 109 x 13 x 140 cm
 max. 164 x 13 x 195 cm
 min. 140 x 13 x 109 cm
 max. 195 x 13 x 164 cm

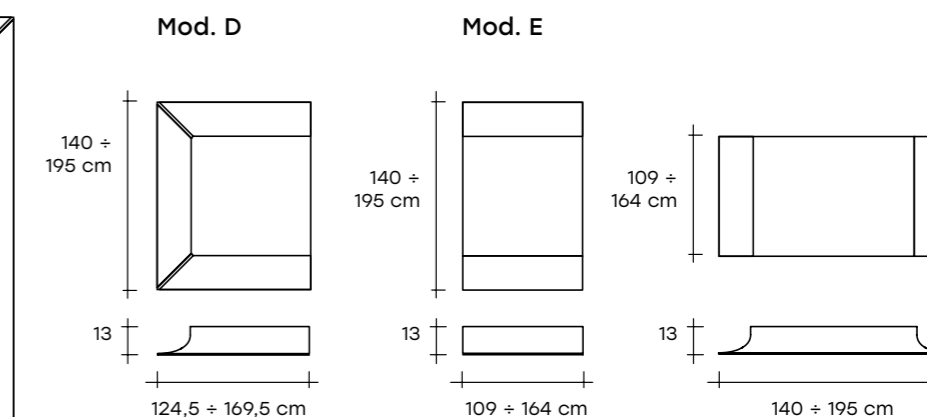
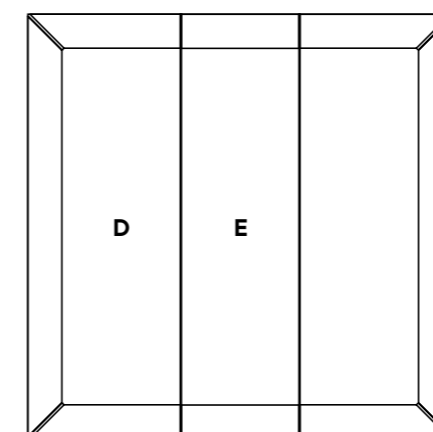

mirage

DESIGN
DANIEL LIBESKIND

Specchio da parete con cornice in alluminio finitura brill. Lo specchio offre sia un'ampia gamma di misure che un'ampia possibilità di customizzazione.

Wall mirror with brill finish aluminium frame. The mirror is available in a wide range of sizes and offers several customization solutions.

Miroir à accrocher avec cadre en aluminium finition brill. Le miroir offre un vaste assortiment de mesures et une large gamme de personnalisation.

Wandspiegel mit Rahmen aus Aluminium Finish Brill. In vielen verschiedenen Größen und Personalisierungen.

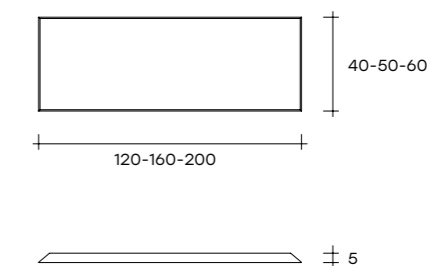
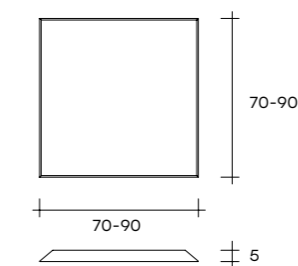

Dimensioni standard
Standard dimensions
Dimensions standards
Standard Abmessungen

70 x 5 x 70 cm
27 9/16" x 2" x 27 9/16"
90 x 5 x 90 cm
35 7/16" x 2" x 35 7/16"
120 x 5 x 40 cm
47 1/4" x 2" x 15 3/4"
160 x 5 x 50 cm
62" x 2" x 19 11/16"
200 x 5 x 60 cm
78 3/4" x 2" x 23 5/8"

Dimensioni custom
Custom dimensions
Dimensions sur demande
Massgefertigte Abmessungen

Lunghezza _ Length _ Longueur _ Länge

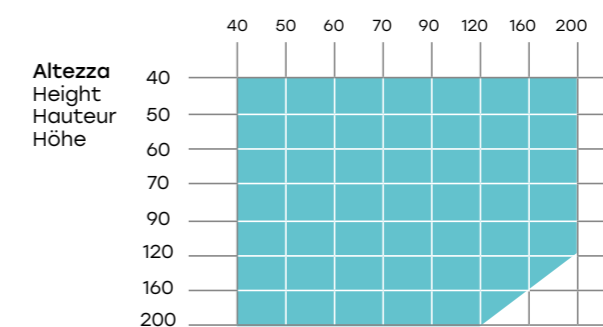

I Customizzabili

The Customizables
Les personnalisables
Die Anpassbaren

VETRINE, ESPOSITORI, MENSOLE

SHOWCASE,
DISPLAY UNIT, SHELVES
VITRINE, PRESENTOIRS,
ÉTAGÈRES
VITRINE, REGALE,
KASTEN

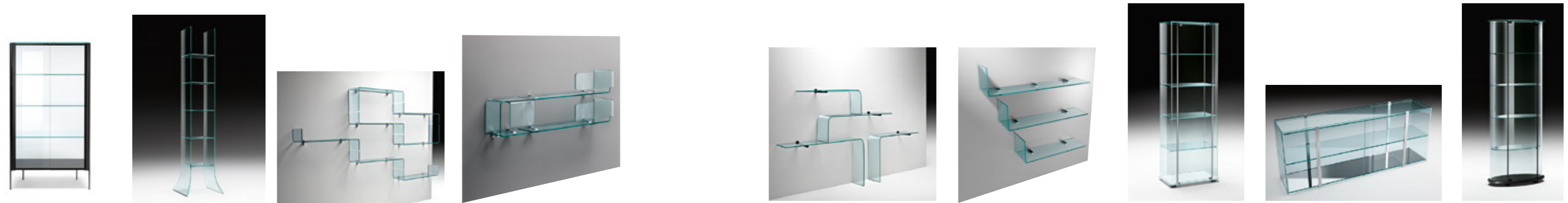

	AURA	BABELE	BABILA	FOULARD	MENSOLE	MENSOLE RIALTO L	MILO	MILO SIDEBOARD	PALLADIO
Misure H. - P. - L. Dimensions H. - W. - L.		•				•		•	
Finiture vetro Glass finish	•	•	•	•	•	•	•	•	•
Laccatura Lacquering	•	•	•	•	•	•	•	•	•



	PALLADIO UNO	PLIE'
Misure H. - P. - L. Dimensions H. - W. - L.		
Finiture vetro Glass finish	•	•
Laccatura Lacquering	•	•

SISTEMI, CONTENITORI COMPONIBILI

SYSTEMS,
CONTAINER CABINETS
SYSTÈMES, MEUBLES
DE RANGEMENT
SYSTEME, KASTEN

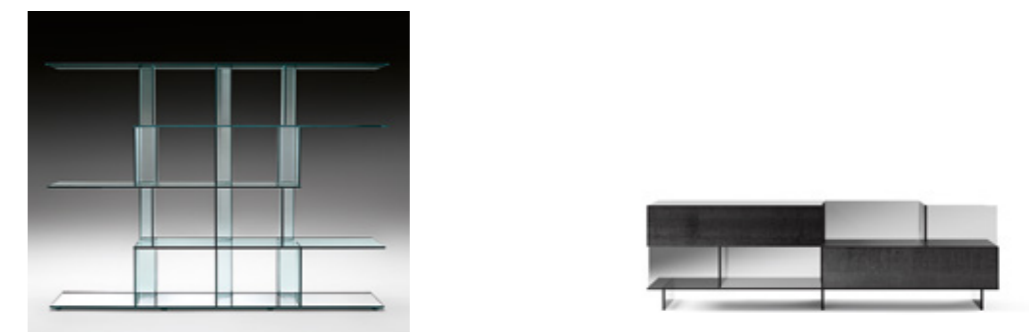

	INORI	VARESINA
Misure H. - P. - L. Dimensions H. - W. - L.	•	•
Finiture vetro Glass finish	•	•
Laccatura Lacquering	•	•



inori

DESIGN SETSU
E SHINOBU ITO

La libreria modulare Inori, disegnata per Fiam da Setsu & Shinobu Ito, è il primo sistema nel settore dell'arredo interamente in vetro composto da elementi modulari. Inori può essere utilizzata come libreria, espositore, contenitore e porta-TV: tutte le soluzioni sono sviluppabili in versioni a parete o autoportanti. La modularità e la versatilità del sistema permettono infatti di creare infinite forme compositive; inoltre base e ripiani possono essere personalizzabili nella lunghezza e nei colori, raggiungendo così un elevato grado di customizzazione.

The Inori modular bookcase, designed for Fiam by Setsu & Shinobu Ito, is the first system in the furniture industry entirely made of glass, and composed of modular elements. Inori can be used as a bookcase, a display, a container, and a TV stand: all solutions are developable in wall or freestanding versions. The modularity and versatility allows you to create endless compositional shapes. Base and shelves can also be customized for length and colours, thus achieving a high degree of customisation.

La bibliothèque modulaire Inori, conçue pour Fiam par Setsu & Shinobu Ito, est le premier système dans le secteur qui soit entièrement de verre et composé d'éléments modulaires. Inori peut être utilisée comme une bibliothèque, un présentoir, un contenant et un meuble TV: toutes les solutions sont développables en versions murales ou autonomes. La modularité et la polyvalence permettent de créer des compositions dans une infinité de formes. Les bases et les étagères peuvent également être personnalisées en longueur et en couleurs, atteignant ainsi un haut degré de personnalisation.

Das von Setsu & Shinobu Ito für Fiam designte Modulbücherregal Inori ist im Einrichtungsbereich das erste vollständig aus Glas bestehende Regalsystem, das aus Modulen besteht. Inori kann als Bücherregal, Vitrine, Behälter und TV-Möbel verwendet werden. Alle Lösungen sind in den Ausführungen Wandbefestigung oder stehend erhältlich. Modulsystem und Vielseitigkeit ermöglichen eine unendliche Kombinationen. Die Basis und die Fachböden sind in Länge und Farbe variabel, was außerdem viel Raum für eine individuelle Gestaltung bietet.



Dimensioni standard Standard dimensions Dimensions standards Standard Abmessungen

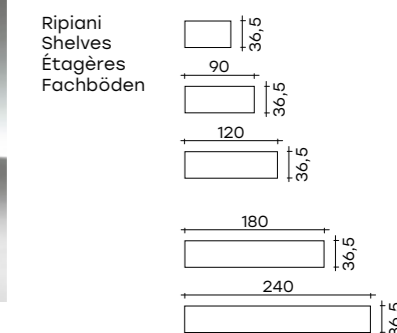
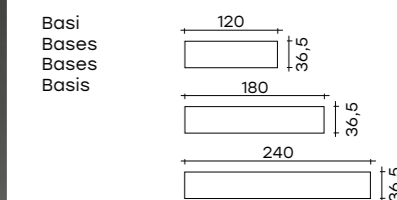

Montanti / Uprights
Montants / Stütze

Ripiani in vetro temperato, spessore 12 mm o legno spessore 40 mm.

Shelves in tempered glass,
12 mm-thick or wood 40 mm-thick.
Étagères en verre trempé
de 12 mm. Étagères en bois,
épaisseur 40 mm.

Fachböden aus gehärtetem
12 mm starkem Glas.
Holzfachböden, 40 mm Stärke.

Base d'appoggio in vetro temperato, spessore 12 mm o legno spessore 40 mm.

Base in tempered glass,
12 mm-thick
or wood 40 mm-thick.

Base en verre trempé de 12 mm.
Base en bois, épaisseur 40 mm.
Basis aus gehärtetem 12 mm
starkem Glas.
Holzbasis, 40 mm Stärke.

Montanti in vetro curvato da 10 mm.

Uprights in curved glass,
10 mm-thick.

Montants en verre
cintré de 10 mm.
Stütze aus gebogenem
Glas, 10 mm.

Altezza massima per le strutture autoportanti

Su basi di lunghezza 120 cm: h max 50 cm
Su basi di lunghezza 180 cm: h max 135 cm
Su basi di lunghezza 240 cm solo vetro: h 180 cm,
con accessorio dedicato

Altezza massima per le strutture con ancoraggio a muro:

massimo 5 ripiani totali, base esclusa

Max. height of the free-standing version

With base length 120 cm: h max 50 cm
With base length 180 cm: h max 135 cm
With base length 240 cm glass version:
h 180 cm, with accessories

Max. height of the wall version:

max 5 shelves, base excluded

Hauteur maxi. pour les structures posées au sol

Avec base de longueur 120 cm: h max 50 cm
Avec base de longueur 180/240 cm: h max 135 cm
Avec base de longueur 240 cm:

a partir de h 135 cm à 180 cm, avec accessoires

Hauteur maxi. pour les structures accrochables au mur:

avec max 5 étagères base excluse.

Max. Höhe der Standausführung

mit Basislänge 180 / 240 cm: H max 90 cm
mit Basislänge 120 cm: H max 50 cm
mit Basislänge 240 cm: von H 135 bis H 180 cm,
mit Accessoires

Max. Höhe der Wandausführung:

mit max 5 Fachböden die Basis ausgeschlossen.

portata sui ripiani: 80 kg
portata massima
struttura: 400 kg
distanza massima
tra i montanti: 130 cm

load capacity on shelves: 80 kg
structure load capacity: 400 kg
max. distance between
the uprights: 130 cm

portée sur les étagères: 80 kg
portée max structure: 400 kg
distance maxi entre
les montants: 130 cm

Tragfähigkeit
der Fachboden: 80 kg
Tragfähigkeit der Struktur: 400 kg
Max. Abstand zwischen
den Stützen: 130 cm



mensole rialto L

DESIGN
CRS FIAM

Versione a forma di lettera "L" in appoggio su cassettera. In questo oggetto di design, personalizzabile, la sintesi di Rialto compie un ulteriore passo avanti. Il Centro Ricerca e Stile Fiam sviluppa un capolavoro di progettazione, minimale ed elegante, stabile e sorretto dalla migliore ricerca tecnologica nel settore del cristallo curvato.

L-shaped version standing on a drawer unit. In this customisable design piece, Rialto's synthesis becomes even more absolute. The Fiam Research and Style Centre has achieved a design masterpiece, minimal and elegant, stable and supported by the best technological research in the curved plate glass sector.

Version en forme de « L » avec appui sur le meuble à tiroirs. Dans cet objet de design personnalisable, les capacités de synthèse de Rialto passent à un niveau supérieur. Le Centre de Recherche et de Style Fiam a développé un chef-d'œuvre de conception minimale et élégante, stable et reposant sur la meilleure recherche technologique dans le secteur du verre cintré.

L-förmige Version, die auf dem Schubladenkasten aufliegt. Mit diesem personalisierbaren Design-Gegenstand gelingt dem Zusammenspiel von Rialto ein weiterer Schritt nach vorne. Die Abteilung für Forschung und Stil von Fiam schafft ein Meisterwerk der Projektierung, minimal und elegant, stabil und getragen von der besten technologischen Forschung im Bereich des gebogenen Glases.

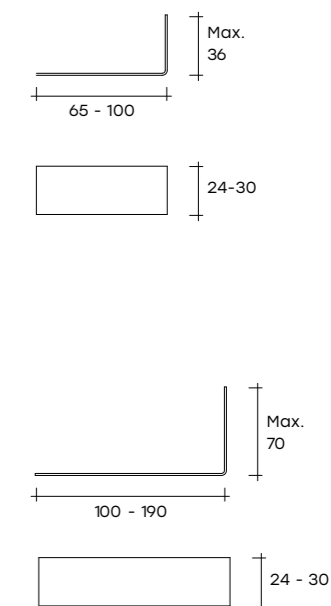

Dimensioni standard
Standard dimensions
Dimensions standards
Standard Abmessungen

L. P. H. _ L. W. H.

190 x 30 x 40 cm
74 ¹³/₁₆" x 11 ¹³/₁₆" x 15 ³/₄"

140 x 24 x 40 cm
55 ¹/₈" x 9 ⁷/₁₆" x 15 ³/₄"

100 x 24 x 36 cm
39 ³/₈" x 9 ⁷/₁₆" x 14 ³/₁₆"

65 x 24 x 30 cm
25 ⁹/₁₆" x 9 ⁷/₁₆" x 11 ¹³/₁₆"

Dimensioni custom
Custom dimensions
Dimensions sur demande
Massgefertigte Abmessungen

Lunghezza _ Length _ Longueur _ Länge

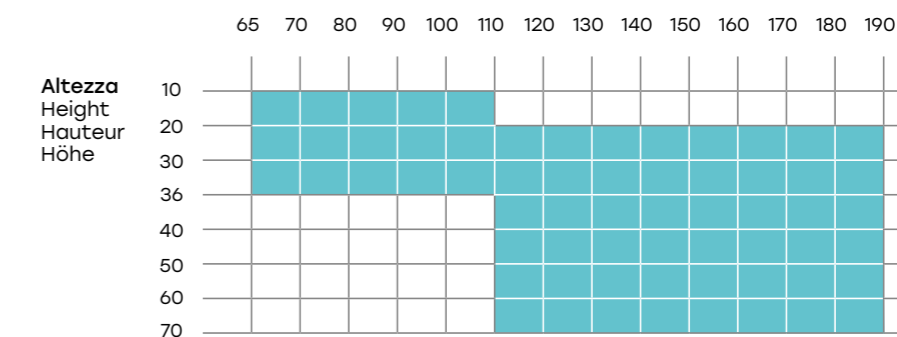

Profondità: può essere scelta liberamente tra un minimo di 24 cm ed un massimo di 30 cm.

Width: can be chosen freely from a minimum of 24 cm and a maximum of 30 cm.

La profondeur se peut réaliser entre mini. 24 cm - maxi. 30 cm.

Tiefe wahlweise zwischen min. 24 cm maxi. 30 cm.



I Customizzabili

The Customizables

Les personnalisables

Die Anpassbaren

TAVOLI

TABLES
TABLES
TISCHE



	ATLAS	CORNER	EPSYLON	LLT	LUXOR	MONTEFELTRO	PLIÉ	RAY	SAHARA
Misure H. - P. - L. Dimensions H. - W. - L.		•		•	•				
Dimensione del Top Top dimension	•	•	•	•	•	•	•	•	•
Finiture vetro Glass finish		•	•		•		•		•
Laccatura Lacquering		•	•	•	•	•	•	•	•

TAVOLI MULTIMATERICI

MULTIMATERIAL
TABLES
TABLES
MULTIMATERIEUX
MULTIMATERIALIEN-
TISCHE



	LLT WOOD	PLIÉ	VARESINA
Misure H. - P. - L. Dimensions H. - W. - L.	•		
Dimensione del Top Top dimension	•		•
Finiture vetro Glass finish		•	•
Laccatura Lacquering		•	•

TAVOLI ALLUNGABILI

EXTENSIBLE TABLES
TABLES À RALLONGE
AUSZIEHTISCHE



	KAYO	RAY PLUS
Misure H. - P. - L. Dimensions H. - W. - L.		
Dimensione del Top Top dimension	•	•
Finiture vetro Glass finish		
Laccatura Lacquering	•	•

luxor

DESIGN
RODOLFO DORDONI

Luxor del designer italiano Rodolfo Dordoni, offre possibilità di personalizzazione davvero interessanti. Questa è la peculiarità che ha caratterizzato un tavolo di successo, precursore assoluto del full-custom. Luxor si può declinare in piccole e medie dimensioni quadrate o rettangolari, per eleganti scrivanie direzionali e da lavoro, oppure in grandi "formati" dalle forme originali per arredare sale riunione o reception. Il Luxor ha fatto della flessibilità d'utilizzo la chiave del proprio successo, è il pezzo che per primo ha interpretato la filosofia del full custom.

Luxor, by the Italian designer Rodolfo Dordoni, offers amazing customisation potential. This has been the secret of success for the table that pointed the way to the full-custom approach. Luxor can be produced in small and medium sizes, square or rectangular, for elegant executive and office desks, or in large sizes with original shapes to furnish meeting rooms or reception areas. In Luxor, Dordoni's product made flexibility the key to its success, and it was the first piece to incorporate the full custom philosophy.

La table Luxor du designer italien Rodolfo Dordoni, offre des possibilités de personnalisation vraiment intéressante. Ceci est la particularité que a caractérisé une table de succès. Précurseur absolu du full-custom. Luxor peut s'adapter dans les petites et les moyennes tailles, carrées ou rectangulaires, pour les bureaux exécutifs élégants et du travail, ou dans de grands formats, formes originales pour décorer les salles réunion ou réception. La table Luxor, le produit de Dordoni a fait de sa gamme d'utilisation la clé de son succès, est la pièce qui a d'abord joué la philosophie du produit entièrement personnalisée.

Luxor vom italienischen Designers Rodolfo Dordoni, bietet verschiedene und interessante Möglichkeiten. Dies ist die Besonderheit eines erfolgreichen Tisches, absolute Vorläufer der Full-Custom. Luxor in kleinen und mittleren, quadratischen oder rechteckigen Abmessungen, für elegante Executivschreibtische oder für Arbeitstische, oder in großen "Formate" und besonderen Gestaltungen richtet er Konferenz- bzw. Empfangsräume, ein. Die Nutzungsflexibilität des Luxor von Dordoni ist das Erfolgsrezept von diesem Stück, das zuerst die Philosophie des „Full-Custom“ interpretiert.



Dimensioni standard

Standard dimensions
Dimensions standards
Standard Abmessungen

L. P. H. _ L. W. H.

220 x 110 x 75 cm
(con 3 basi _ with 3 legs)
240 x 120 x 75 cm
(con 3 basi _ with 3 legs)
150 x 150 x 75 cm
(con 3 basi _ with 3 legs)

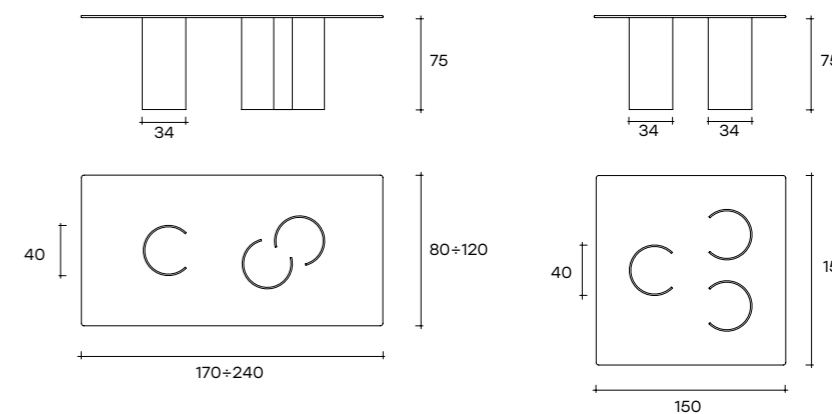

Dimensioni custom

Custom dimensions
Dimensions sur demande
Massgefertigte Abmessungen

L. P. H. _ L. W. H.

350 x 120 x 74 cm
137 13/16" x 47 1/4" x 29 1/8"

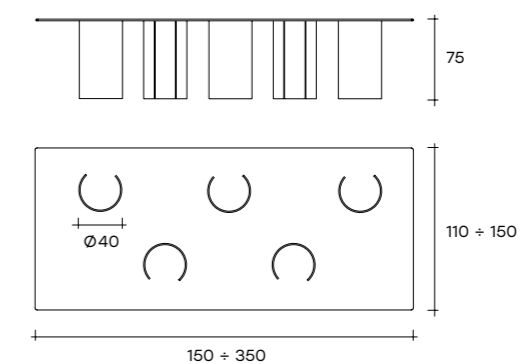

DIMENSIONI CUSTOM _ CUSTOM DIMENSIONS _ DIMENSIONS SUR DEMANDE _ MASSGEFERTIGTE ABMESSUNGEN
L. P. H. _ L. W. H.
PIANI _ PIANI _ PLATEAU _ GLASPLATTE
Dimensione massima
con 3 basi:

 Rettangolare 240 x 120 cm
 Quadrato 160 x 160 cm
 Rotondo ø 160 cm
 Ovale 240 x 170 cm
 Ellittico 240 x 170 cm

Dimensione massima
con 4 o più basi:

Contattare l'azienda

Maximum size with 3 bases:

 Rectangular 240 x 120 cm
 Square 160 x 160 cm
 Round ø 160 cm
 Oval 240 x 170 cm
 Elliptical 240 x 170 cm

Maximum size
with 4 or more bases:
 For information please
 contact Fiam sales
 department

Dimensions maxi. avec 3 bases:

 Rectangulaire 240 x 120 cm
 Carré 160 x 160 cm
 Rond ø 160 cm
 Oval 240 x 170 cm
 elliptique 240 x 170 cm

Dimensions maxi.
avec 4 ou plus bases:
 Pour renseignements veuillez
 contacter le Service Ventes

Max. Maße mit 3 Zylinderbasis:

 Rechteckig 240 x 120 cm
 Viereckig 160 x 160 cm
 Rund ø 160 cm
 Oval 240 x 170 cm
 Elliptisch 240 x 170 cm

Max. Maße
mit 4 bzw. mehr, Zylinderbasis:
 Mehrere Auskunfte beim
 Verkaufsdienst.

BASI _ BASES _ BASES _ UNTERGESTELLE
Dimensione minima
 h 20 cm

Minimum size
 h 20 cm

Dimension mini.
 h 20 cm

Min. Maße
 h 20 cm

Dimensione massima
 h 120 cm

Maximum size
 h 120 cm

Dimension maxi.
 h 120 cm

Max. Maße
 h 120 cm

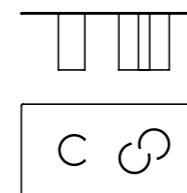
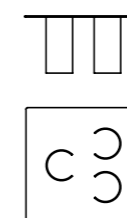
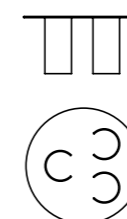
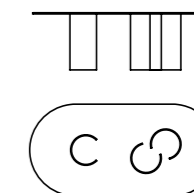
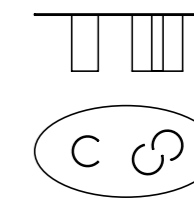
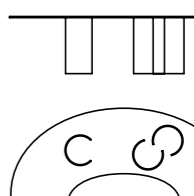
PIANO
RETTANGOLARE
 RECTANGULAR TOP
 PLATEAU
 RECTANGULAIRE
 RECHTECKIGE
 GLASPLATTE

PIANO QUADRATO
 SQUARE TOP
 PLATEAU CARRÉ
 VIERECKIGE
 GLASPLATTE

PIANO ROTONDO
 ROUND TOP
 PLATEAU ROND
 RUNDE GLASPLATTE

PIANO OVALE
 OVAL TOP
 PLATEAU OVALE
 OVALE GLASPLATTE

PIANO ELLITTICO
 ELLIPTICAL TOP
 PLATEAU ELLIPTIQUE
 ELLIPSENFÖRMIGE
 GLASPLATTE

PIANO CON FORMA
A RICHIESTA
 CUSTOMIZED SHAPE TOP
 PLATEAU DE FORME
 PERSONNALISÉE
 MASSGEFERTIGTE
 GLASPLATTEGESTALT

TAVOLI BASSI

COFFEE TABLES
TABLES BASSES
COUCHTISCHE

	ATLAS	C&C	CHARLOTTE	FLUTE	GENIO	MANTA	NEUTRA	PONTE	QUADRA
Misure H. - P. - L. Dimensions H. - W. - L.	•								
Dimensione del Top Top dimension	•			•					•
Finiture vetro Glass finish		•	•	•	•	•	•	•	•
Laccatura Lacquering		•	•	•	•	•	•	•	•



	RIALTO (SQUARE, PIANO, TRIS)	ROY
Misure H. - P. - L. Dimensions H. - W. - L.	•	
Dimensione del Top Top dimension		•
Finiture vetro Glass finish	•	•
Laccatura Lacquering	•	•

TAVOLI
DI SERVIZIOSIDE-TABLES
TABLES D'APPOINT
BEISTELLTISCHE

	C&C SIDE	CHARLOTTE DE NUIT	CHARLOTTE TRIS	GRILLO
Misure H. - P. - L. Dimensions H. - W. - L.				
Dimensione del Top Top dimension				
Finiture vetro Glass finish	•	•	•	•
Laccatura Lacquering	•	•	•	



	RIALTO (TRIS, SIDE, NIGHT)
Misure H. - P. - L. Dimensions H. - W. - L.	•
Dimensione del Top Top dimension	
Finiture vetro Glass finish	•
Laccatura Lacquering	•

CONSOLLE
CONSOLES
CONSOLES
KONSOLE

	CHARLOTTE	DAMA	ELEMENTARE	LLT CONSOLE	LET ME SEE	RIALTO CONSOLE
Misure H. - P. - L. Dimensions H. - W. - L.				•		•
Finiture vetro Glass finish	•	•	•		•	•
Laccatura Lacquering	•	•	•			•



rialto

DESIGN
CRS FIAM

Frutto di sintesi estrema, è il tavolo con la forma più essenziale che esista. Nella progettazione di questo "classico", Fiam ha proceduto per sottrazione, sviluppando una tecnologia di curvatura del vetro esclusiva che le ha permesso di declinare l'articolo in tutte le dimensioni disponibili.

A return to first principles, it is the table with the simplest possible form. When designing this classic, Fiam proceeded by subtraction, developing an exclusive glass bending technique allowing the article to be produced in all the sizes available.

le résultat de la synthèse extrême, est la table avec la forme plus essentiel qu'il y ait. Dans la conception de cette pièce "classique", Fiam a procédé par soustraction, et a développé une technologie exclusive pour le cintrage du verre permettant de proposer l'article dans toutes les tailles disponibles.

Das Ergebnis der extremen Synthese ist der Tisch mit der hoch wesentlichen Form. Im Design dieses "Klassiker", fuhr Fiam durch Subtraktion, durch die Entwicklung einer exklusiver Glasbiegetechnik die erlaubte, den Artikel in allen verfügbaren Größen zu bieten.

Dimensioni standard
 Standard dimensions
 Dimensions standards
 Standard Abmessungen

spessore / thickness
épaisseur / Stärke
12 mm

130 x 68 x 32 cm
51 ³/₁₆" x 26 ³/₄" x 12 ⁵/₈"
120 x 60 x 43 cm
47 ¹/₄" x 23 ⁵/₈" x 16 ¹⁵/₁₆"
130 x 68 x 43 cm
51 ³/₁₆" x 26 ³/₄" x 16 ¹⁵/₁₆"
120 x 120 x 32 cm
47 ¹/₄" x 47 ¹/₄" x 12 ⁵/₈"
120 x 120 x 43 cm
47 ¹/₄" x 47 ¹/₄" x 16 ¹⁵/₁₆"
140 x 140 x 32 cm
55 ¹/₈" x 55 ¹/₈" x 12 ⁵/₈"
140 x 140 x 43 cm
55 ¹/₈" x 55 ¹/₈" x 16 ¹⁵/₁₆"

spessore / thickness
épaisseur / Stärke
10 mm

100 x 60 x 32* cm
39 ³/₈" x 23 ⁵/₈" x 12 ⁵/₈"

spessore / thickness
épaisseur / Stärke
15 mm

160 x 52 x 22 cm
63" x 20 ¹/₂" x 8 ¹¹/₁₆"

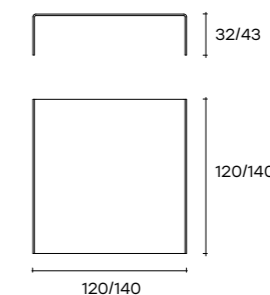
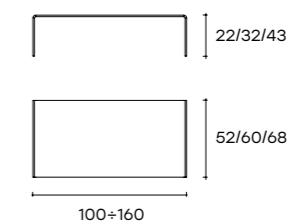

Esempi fra le innumerevoli soluzioni custom
 Examples among the many custom solutions
 Exemples parmi les nombreuses solutions sur demande
 Beispiele unter den vielen Lösungen



Scrivania
 Desk _ Bureau _ Schreibtisch

L. P. H. _ L. W. H.
 120x60x73 cm

Dimensione minima
 Minimum size
 Dimensions mini.
 Min. Maße
 100x60x73 cm

Dimensione massima
 Maximum size
 Dimensions maxi.
 Max. Maße
 160x80x73 cm



Tavolino
 Coffee table
 Table basse
 Couchtisch

L. P. H. _ L. W. H.
 70x35x45 cm

Dimensione minima
 Minimum size
 Dimensions mini.
 Min. Maße
 40x40x22 cm

Dimensione massima
 Maximum size
 Dimensions maxi.
 Max. Maße
 100x100x42 cm



Consolle
 Console _ Console _ Konsole

L. P. H. _ L. W. H.
 100x40x90 cm

Dimensione minima
 Minimum size
 Dimensions mini.
 Min. Maße
 90x30x75 cm

Dimensione massima
 Maximum size
 Dimensions maxi.
 Max. Maße
 120x45x90 cm



Work station
 Workstation
 Poste de travail
 Arbeitsstelle

L. P. H. _ L. W. H.
 80x65x73 cm

Dimensione minima
 Minimum size
 Dimensions mini.
 Min. Maße
 70x50x73 cm

Dimensione massima
 Maximum size
 Dimensions maxi.
 Max. Maße
 100x70x73 cm



Mobile porta stampante
 Printer stand
 Meuble pour imprimante
 Druckergestell

L. P. H. _ L. W. H.
 85x32x55 cm

Dimensione minima
 Minimum size
 Dimensions mini.
 Min. Maße
 50x30x55 cm

Dimensione massima
 Maximum size
 Dimensions maxi.
 Max. Maße
 100x45x65 cm

Dimensioni custom
 Custom dimensions _ Dimensions sur demande _ Massgefertigte Abmessungen

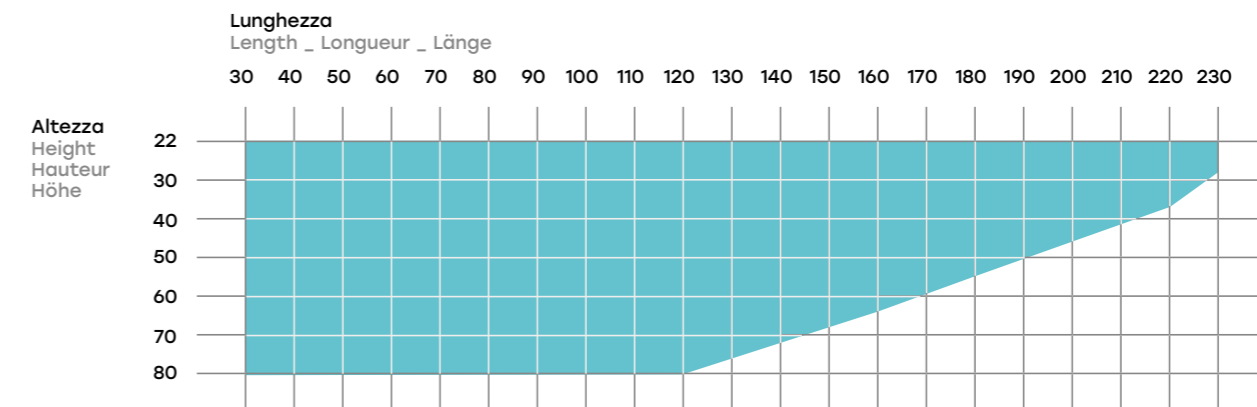

Profondità: può essere scelta liberamente tra un minimo di 30 cm ed un massimo di 100 cm.
 Width: can be chosen freely from a minimum of 30 cm and a maximum of 100 cm.
 La profondeur se peut réaliser entre mini.30 cm - maxi. 100 cm.
 Tiefe wahlweise zwischen min.30 cm maxi. 100 cm.



I Customizzabili

The Customizables
Les personnalisables
Die Anpassbaren

HOME OFFICE

SCRIVANIE

DESKS
BUREAUX
SCHREIBTISCHE

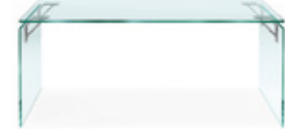

	ATLAS	BRIGHT	GRAPH	LLT (HOME, OFX EXECUTIVE)	RIALTO (L, WALL MOUNTED, ISOLA)
Misure H. - P. - L. Dimensions H. - W. - L.		•		•	•
Dimensione del Top Top dimension	•	•		•	
Finiture vetro Glass finish			•		
Laccatura Lacquering		•	•	•	•

TAVOLI MEETING

MEETING TABLES
TABLES DE RÉUNION
BESPRECHUNGS
TISCHE



	LLT OFX MEETING	LUXOR
Misure H. - P. - L. Dimensions H. - W. - L.	•	•
Dimensione del Top Top dimension	•	•
Finiture vetro Glass finish		•
Laccatura Lacquering	•	•

SISTEMI, MENSOLE

SYSTEMS, SHELVES
SYSTÈMES, ÉTAGÈRES
SYSTEME, KASTEN



	INORI	MENSOLE RIALTO L
Misure H. - P. - L. Dimensions H. - W. - L.	•	•
Finiture vetro Glass finish	•	•
Laccatura Lacquering	•	•

bright

DESIGN
CRS FIAM

L'impiego del vetro nel design di un tavolo suggerisce immediatamente il contrasto fra la solidità che la sua struttura deve poter esibire con la naturale leggerezza visiva del vetro. Valerio Cometti ed il suo team dello studio V12 Design, con la scrivania/tavolo BRIGHT hanno voluto spingere in là i limiti di questo contrasto, realizzando un progetto che introduce un ulteriore elemento di leggerezza: la separazione fra il ripiano orizzontale e le strutture verticali delle gambe. Oltre alla leggerezza gli hanno conferito la flessibilità progettuale con i suoi elementi in vetro autonomi e smontabili che la rendono perfetta per essere personalizzata in tutte e tre le dimensioni.

The use of glass for the design of a table immediately suggests the contrast between the solidity that its structure must show and the natural visual lightness of glass. Valerio Cometti and his team from studio V12 Design, with the BRIGHT desk/table, wanted to push the limits of this contrast, creating a project that introduces a further element of lightness: the separation between the horizontal top and the vertical structure of the legs. In addition to lightness, they have given it design flexibility with its independent and removable glass elements which make it perfect to be customized in all three dimensions.

L'utilisation du verre dans la conception d'une table suggère immédiatement le contraste entre la solidité qui ressort de la structure, avec la légèreté visuelle naturelle du verre. En développant le bureau / table BRIGHT, Valerio Cometti et son équipe du studio V12 Design ont voulu redéfinir les limites de ce contraste et réaliser un projet qui introduit un nouvel élément de légèreté: la séparation entre la partie supérieure horizontale et le structure verticale des pieds. Légèreté à part, ils l'ont doté d'une certaine flexibilité de conception, avec ses éléments en verre indépendants et amovibles, qui le rendent adapté à des personnalisations dans les trois dimensions.

Glas als Designelement bei einem Tisch vermittelt sofort den Kontrast zwischen der Festigkeit, die das Gestell vorweisen muss, und der natürlichen, optischen Leichtigkeit des Glases. Mit dem Schreibtische/ Tisch BRIGHT führte Valerio Cometti und sein Team von V12 Design diesen Kontrast über seine Grenzen hinaus. Es entstand ein Projekt, das ein weiteres Element der Leichtigkeit vorsieht: die Trennung zwischen horizontaler Tischplatte und vertikalem Stützgestell. Mit den eigenständigen und erlegbaren Glaselementen wurde nicht nur Leichtigkeit, sondern auch Flexibilität der Kombination geschaffen, wodurch sich das Möbelstück in allen drei Dimensionen persönlich gestalten lässt.



Dimensioni standard
Standard dimensions
Dimensions standards
Standard Abmessungen

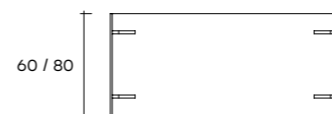
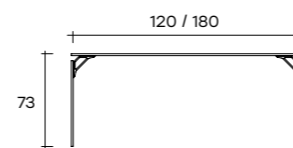

Dimensioni custom
Custom dimensions
Dimensions sur demande
Massgefertigte Abmessungen

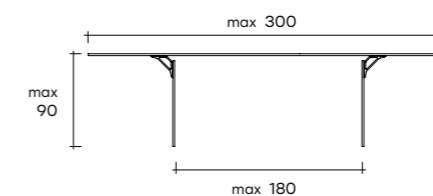

Profondità
Width
Profondeur
Tiefe

Lunghezza
Length _ Longueur _ Länge
60 80 100 120 160 180 200 220 240 260 280 300

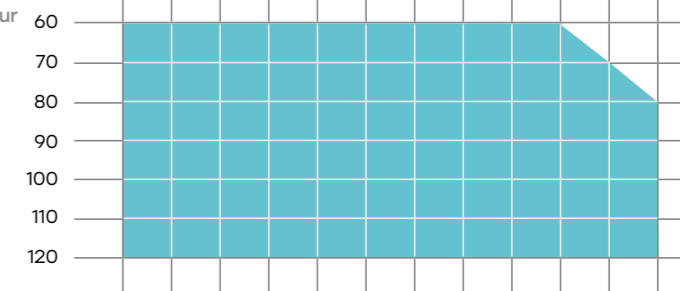

Altezza: può essere scelta liberamente tra un minimo di 30 cm ed un massimo di 90 cm.
Height: can be chosen freely from a minimum of 30 cm and a maximum of 90 cm.
La hauteur se peut réaliser entre mini.30 cm - maxi. 90 cm.
Höhe wahlweise zwischen min.30 cm maxi. 90 cm.



rialto

DESIGN
CRS FIAM

Frutto di sintesi estrema, è la scrivania con la forma più essenziale che esista. Nella progettazione di questo "classico", Fiam ha proceduto per sottrazione, sviluppando una tecnologia di curvatura del vetro esclusiva che le ha permesso di declinare l'articolo in tutte le dimensioni disponibili.

A return to first principles, it is the desk with the simplest possible form. When designing this classic, Fiam proceeded by subtraction, developing an exclusive glass bending technique allowing the article to be produced in all the sizes available.

le résultat de la synthèse extrême, est le bureau avec la forme plus essentielle qu'il y ait. Dans la conception de cette pièce "classique", Fiam a procédé par soustraction, et a développé une technologie exclusive pour le cintrage du verre permettant de proposer l'article dans toutes les tailles disponibles.

Das Ergebnis der extremen Synthese ist der Schreibtisch mit der hoch wesentlichen Form. Im Design dieses "Klassiker", fuhr Fiam durch Subtraktion, durch die Entwicklung einer exklusiver Glasbiegetechnik die erlaubte, den Artikel in allen verfügbaren Größen zu bieten.



Dimensioni standard
Standard dimensions
Dimensions standards
Standard Abmessungen

L. P. H. _ L. W. H.

100 x 60 x 73 cm
120 x 60 x 73 cm
140 x 70 x 73 cm
160 x 70 x 73 cm
160 x 80 x 73 cm

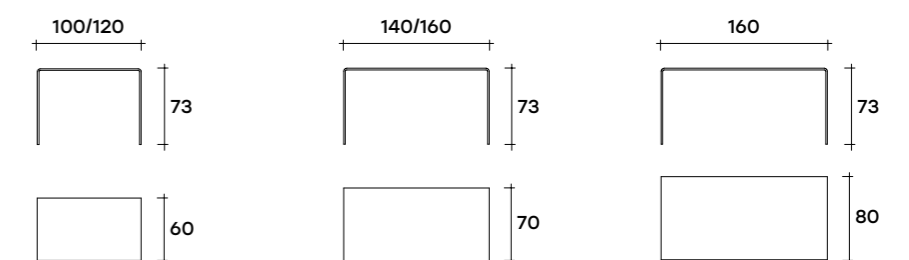

Esempi fra le innumerevoli soluzioni custom
 Examples among the many custom solutions
 Exemples parmi les nombreuses solutions sur demande
 Beispiele unter den vielen Lösungen



Scrivania
 Desk _ Bureau _ Schreibtisch

L. P. H. _ L. W. H.
 120x60x73 cm

Dimensione minima
 Minimum size
 Dimensions mini.
 Min. Maße
 100x60x73 cm

Dimensione massima
 Maximum size
 Dimensions maxi.
 Max. Maße
 160x80x73 cm



Tavolino
 Coffee table
 Table basse
 Couchtisch

L. P. H. _ L. W. H.
 70x35x45 cm

Dimensione minima
 Minimum size
 Dimensions mini.
 Min. Maße
 40x40x22 cm

Dimensione massima
 Maximum size
 Dimensions maxi.
 Max. Maße
 100x100x42 cm



Console
 Console _ Console _ Konsole

L. P. H. _ L. W. H.
 100x40x90 cm

Dimensione minima
 Minimum size
 Dimensions mini.
 Min. Maße
 90x30x75 cm

Dimensione massima
 Maximum size
 Dimensions maxi.
 Max. Maße
 120x45x90 cm



Work station
 Workstation
 Poste de travail
 Arbeitsstelle

L. P. H. _ L. W. H.
 80x65x73 cm

Dimensione minima
 Minimum size
 Dimensions mini.
 Min. Maße
 70x50x73 cm

Dimensione massima
 Maximum size
 Dimensions maxi.
 Max. Maße
 100x70x73 cm



Mobile porta stampante
 Printer stand
 Meuble pour imprimante
 Druckergestell

L. P. H. _ L. W. H.
 85x32x55 cm

Dimensione minima
 Minimum size
 Dimensions mini.
 Min. Maße
 50x30x55 cm

Dimensione massima
 Maximum size
 Dimensions maxi.
 Max. Maße
 100x45x65 cm

Dimensioni custom
 Custom dimensions _ Dimensions sur demande _ Massgefertigte Abmessungen

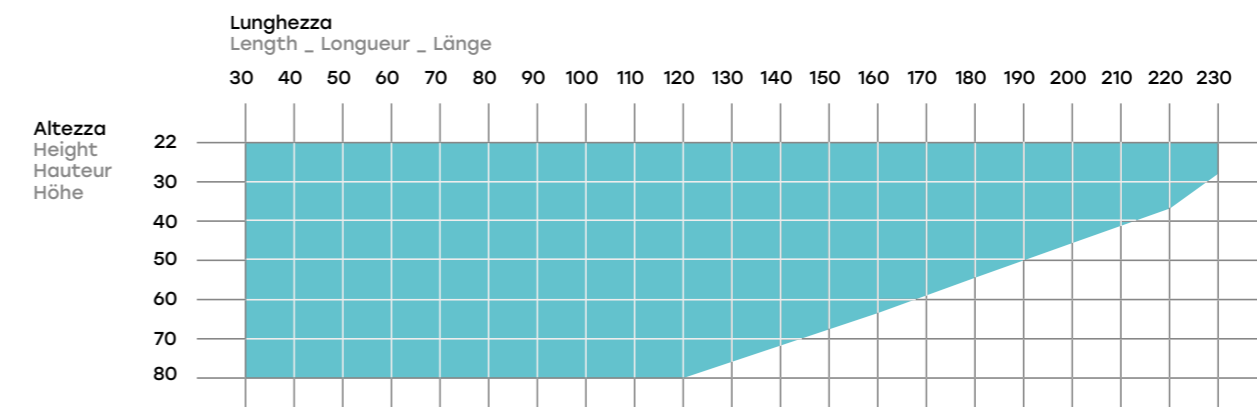

Profondità: può essere scelta liberamente tra un minimo di 30 cm ed un massimo di 100 cm.
 Width: can be chosen freely from a minimum of 30 cm and a maximum of 100 cm.
 La profondeur se peut réaliser entre mini.30 cm - maxi. 100 cm.
 Tiefe wahlweise zwischen min.30 cm maxi. 100 cm.



rialto L

DESIGN
CRS FIAM

Versione a forma di lettera "L" in appoggio su cassetteria. In questo oggetto di design, personalizzabile, la sintesi di Rialto compie un ulteriore passo avanti. Il Centro Ricerca e Stile Fiam sviluppa un capolavoro di progettazione, minimale ed elegante, stabile e sorretto dalla migliore ricerca tecnologica nel settore del cristallo curvato".

L-shaped version standing on a drawer unit. In this customisable design piece, Rialto's synthesis becomes even more absolute. The Fiam Research and Style Centre has achieved a design masterpiece, minimal and elegant, stable and supported by the best technological research in the curved plate glass sector.

Version en forme de « L » avec appui sur le meuble à tiroirs. Dans cet objet de design personnalisable, les capacités de synthèse de Rialto passent à un niveau supérieur. Le Centre de Recherche et de Style Fiam a développé un chef-d'œuvre de conception minimale et élégante, stable et reposant sur la meilleure recherche technologique dans le secteur du verre cintré.

L-förmige Version, die auf dem Schubladenkasten aufliegt. Mit diesem personalisierbaren Design-Gegenstand gelingt dem Zusammenspiel von Rialto ein weiterer Schritt nach vorne. Die Abteilung für Forschung und Stil von Fiam schafft ein Meisterwerk der Projektierung, minimal und elegant, stabil und getragen von der besten technologischen Forschung im Bereich des gebogenen Glases.



Dimensioni standard
Standard dimensions
Dimensions standards
Standard Abmessungen

L. P. H. _ L. W. H.

120 x 60 x 73 cm
140 x 70 x 73 cm
160 x 70 x 73 cm

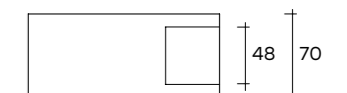
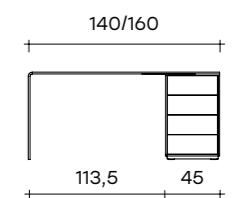
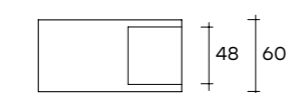
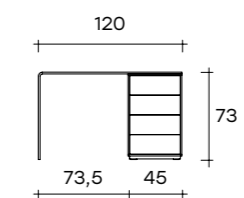

Esempi fra le innumerevoli soluzioni custom
 Examples among the many custom solutions
 Exemples parmi les nombreuses solutions sur demande
 Beispiele unter den vielen Lösungen



Scrivania
 Desk
 Bureau
 Schreibtisch

L. P. H. _ L. W. H.
 225 x 70 x 73 cm

Dimensione minima
 Minimum size
 Dimensions mini.
 Min. Maße
 120 x 60 x 73 cm

Dimensione massima
 Maximum size
 Dimensions maxi.
 Max. Maße
 225 x 90 x 73 cm



Penisola cucina
 Kitchen peninsula
 Péninsule de cuisine
 Kochinsel

L. P. H. _ L. W. H.
 130 x 90 x 90 cm

Dimensione minima
 Minimum size
 Dimensions mini.
 Min. Maße
 90 x 60 x 90 cm

Dimensione massima
 Maximum size
 Dimensions maxi.
 Max. Maße
 200 x 100 x 90 cm



**Postazione/
 penisola a parete**
 Work station/
 wall peninsula
 Poste de travail/
 péninsule à mur
 Arbeitsplatz/
 Wandhalbinsel

L. P. H. _ L. W. H.
 210 x 80 x 73 cm

Dimensione minima
 Minimum size
 Dimensions mini.
 Min. Maße
 90 x 60 x 73 cm

Dimensione massima
 Maximum size
 Dimensions maxi.
 Max. Maße
 210 x 100 x 73 cm

Dimensioni custom
 Custom dimensions _ Dimensions sur demande _ Massgefertigte Abmessungen

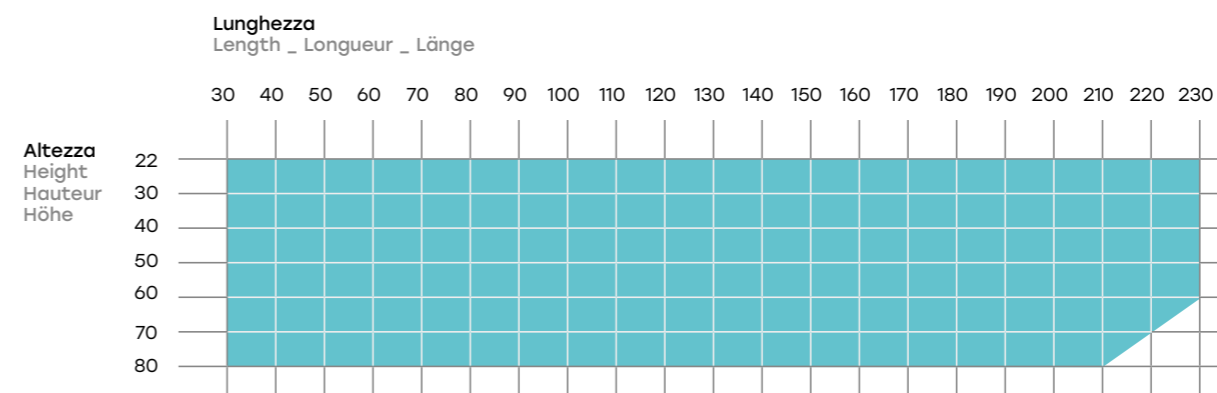

Profondità: può essere scelta liberamente tra un minimo di 30 cm ed un massimo di 100 cm.
 Width: can be chosen freely from a minimum of 30 cm and a maximum of 100 cm.
 La profondeur se peut réaliser entre mini.30 cm – maxi. 100 cm.
 Tiefe wahlweise zwischen min.30 cm maxi. 100 cm.

materiali materials

vetro trasparente transparent glass

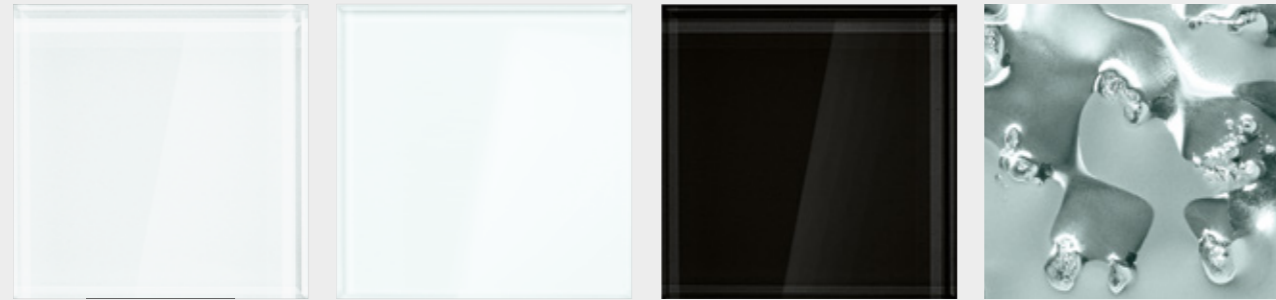

- V1**
Vetro trasparente
Transparent glass
- V2**
Vetro trasparente acidato
Etched glass
- V4**
Vetro trasparente retroverniciato nero
Black back-painted glass
- V5**
Vetro trasparente fuso argentato
Back-silvered fused glass

vetro extralight extralight glass

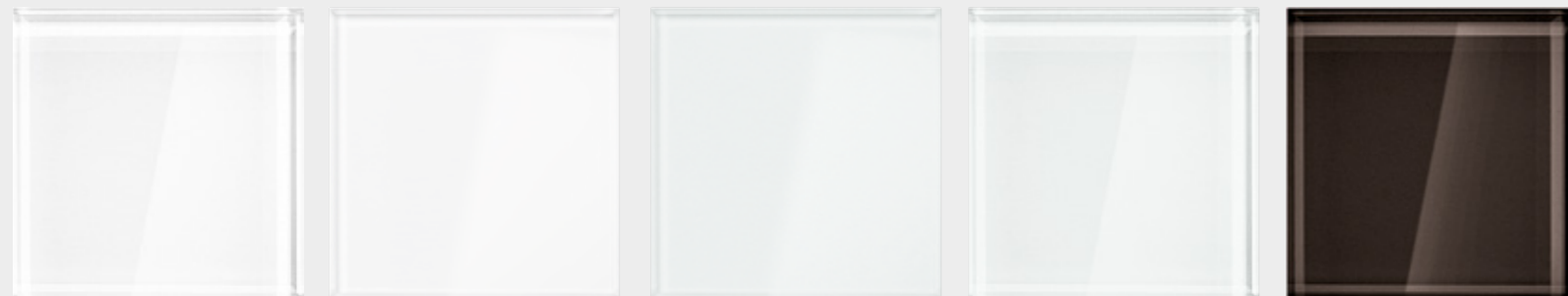

- VX1**
Vetro extralight
Extralight glass
- VX2**
Vetro extralight acidato
Etched extralight glass
- VX3**
Vetro extralight acidato retroverniciato bianco
White back-painted and etched extralight glass
- VX4**
Vetro extralight retroverniciato bianco
White back-painted extralight glass
- VX7**
Vetro extralight retroverniciato "marrone-grigio"
"Brown-grey" back-painted extralight glass



- VX8**
Vetro extralight retroverniciato "grigio polvere"
"Powder grey" back-painted extralight glass

altri vetri other glasses



- AV1**
Vetro fumé
Smoked glass
- AV2**
Vetro bronzo
Bronze glass
- AV3**
Vetro nero 95
Black 95 glass
- AV5**
Vetro titanium
Titanium glass
- AV6**
Vetro bianco opale
Opal glass

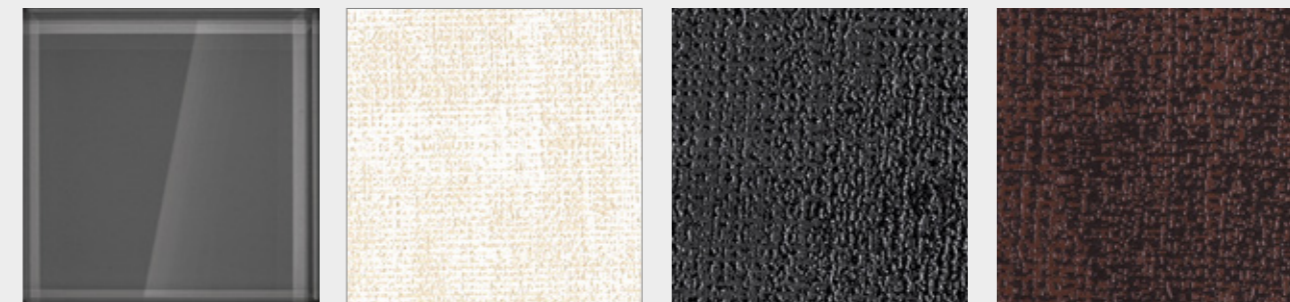

- AV8**
Vetro fumé retroargentato
Back-silvered smoked glass
- AV11**
Vetro "Skinglass" Avorio
"Skinglass" Ivory finish
- AV12**
Vetro "Skinglass" Grafite
"Skinglass" Graphite finish
- AV13**
Vetro "Skinglass" Moka
"Skinglass" Moka finish

legno wood

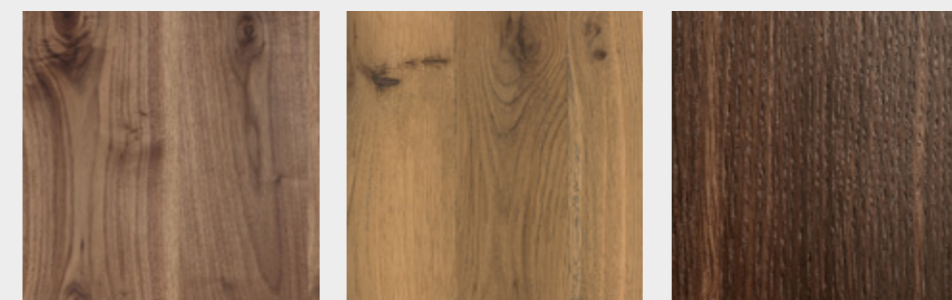

- L7**
Noce canaletto
Canaletto walnut
- L8**
Rovere "old"
"Old style" oak
- L9**
Rovere termotrattato
Heat-treated oak

pelle leather

DI SERIE _ STANDARD

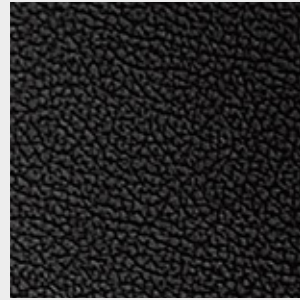

F04
Pelle nera
Leather black



F05
Pelle bianca
Leather white

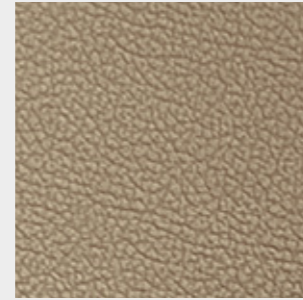

F20
Pelle fumo
Leather smoke

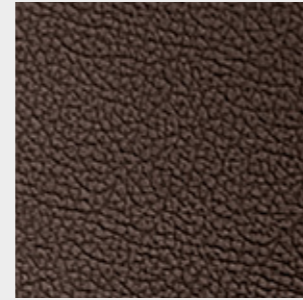

F25
Pelle caffè
Leather coffee

cuoio hide

DI SERIE _ STANDARD

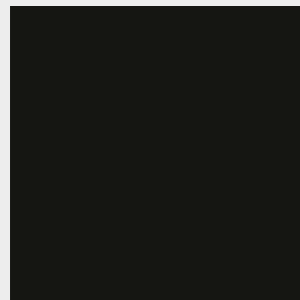

U04
Cuoio nero
Hide black

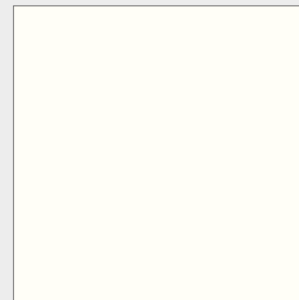

U05
Cuoio bianco
Hide white

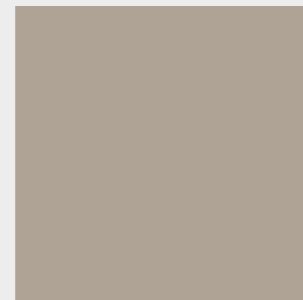

U18
Cuoio grigio cenere
Hide ash grey

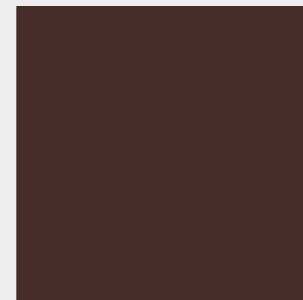

U25
Cuoio caffè
Hide coffee

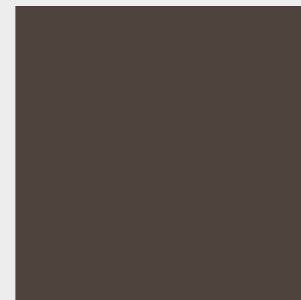

U41
Cuoio testa di moro
Hide dark brown

cuoio hide

SU RICHIESTA _ ON REQUEST



U01
Cuoio rosso bulgaro
Hide red bulgaro



U02
Cuoio grigio scuro
Hide dark grey



U21
Cuoio arancio
Hide orange



U21
Cuoio ocre
Hide ochre



U34
Cuoio vaniglia
Hide vanilla



U42
Cuoio rosso
Hide red



U53
Cuoio avana
Hide havana

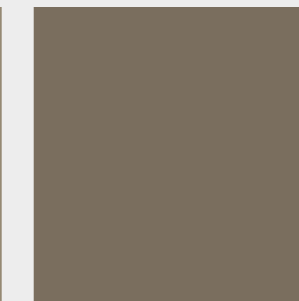

U54
Cuoio fango
Hide fango

mini collection

È noto che FIAM Italia, nella lavorazione del vetro curvato, può definirsi unica al mondo. Le sue creazioni rappresentano ormai storici "capolavori", originali per concezione progettuale, inimitabili per rigore stilistico e impeccabile esecuzione. L'idea di realizzare "miniature" dei prodotti storici FIAM Italia nasce nel 2000. L'intento è quello di proporre una collezione di opere in scala ridotta che testimoniano l'unicità del cristallo curvato oltre a dimostrare allo stesso tempo come tali opere, assunta una nuova veste e una nuova dimensione, possano continuare ad offrire un'alta carica espressiva capace di aggiungere bellezza, poesia ed un tocco di vita in più alle nostre case.

FIAM Italia's world-wide unique status in the processing of curved glass is universally acknowledged. Its creations have become historic masterpieces, original in their design concept, inimitable in their exquisite styling and impeccable craftsmanship. The idea of producing miniatures of FIAM Italia's most famous products dates from 2000. The aim was to offer a collection of works on a small scale that would illustrate the unique features of curved plate glass as well as proving that, even in a new form and size, these works still have a striking expressive charge, capable of adding beauty, poetry and a touch of extra life to our homes.

On sait que FIAM Italia, dans le travail du verre cintré, peut se considérer comme étant unique au monde. Ses créations sont des « chefs-d'oeuvre » historiques, dont la conception de projet est originale, et la rigueur stylistique et l'exécution impeccable inimitables. L'idée de réaliser des « miniatures » des produits historiques FIAM Italia est née en l'an 2000. L'intention était de proposer une collection de pièces à l'échelle réduite exprimant le caractère unique du cristal cintré et de démontrer que ces pièces, habillées d'une nouvelle présentation et d'une nouvelle dimension, pouvaient continuer à dégager une charge expressive en mesure d'ajouter de la beauté, de la poésie et une touche de vie à votre intérieur.

FIAM Italia ist auf der ganzen Welt für seine einzigartigen Produkte aus gebogenem Glas bekannt. Viele Kreationen von FIAM Italia gelten auf Grund ihres außergewöhnlichen Konzepts, ihres unnachahmbaren Stils und ihrer exzellenten Ausführung als wahre Meisterwerke des internationalen Designs. Die Idee, Miniaturmodelle dieser in die Geschichte des Designs eingegangenen Meisterwerke herzustellen, wurde bereits im Jahr 2000 geboren, mit der Absicht, eine Kollektion von maßstabgetreuen Modellen zu schaffen, die Zeugnis von der Einzigartigkeit des gebogenen Kristall-glasses ablegen und gleichzeitig unter Beweis stellen, dass diese Meisterwerke auch in einer neuen Aufmachung und im Miniaturformat ihre ganze Ausdruckskraft beibehalten und unser Zuhause mit Schönheit, Poesie und einem Hauch von Leben bereichern.

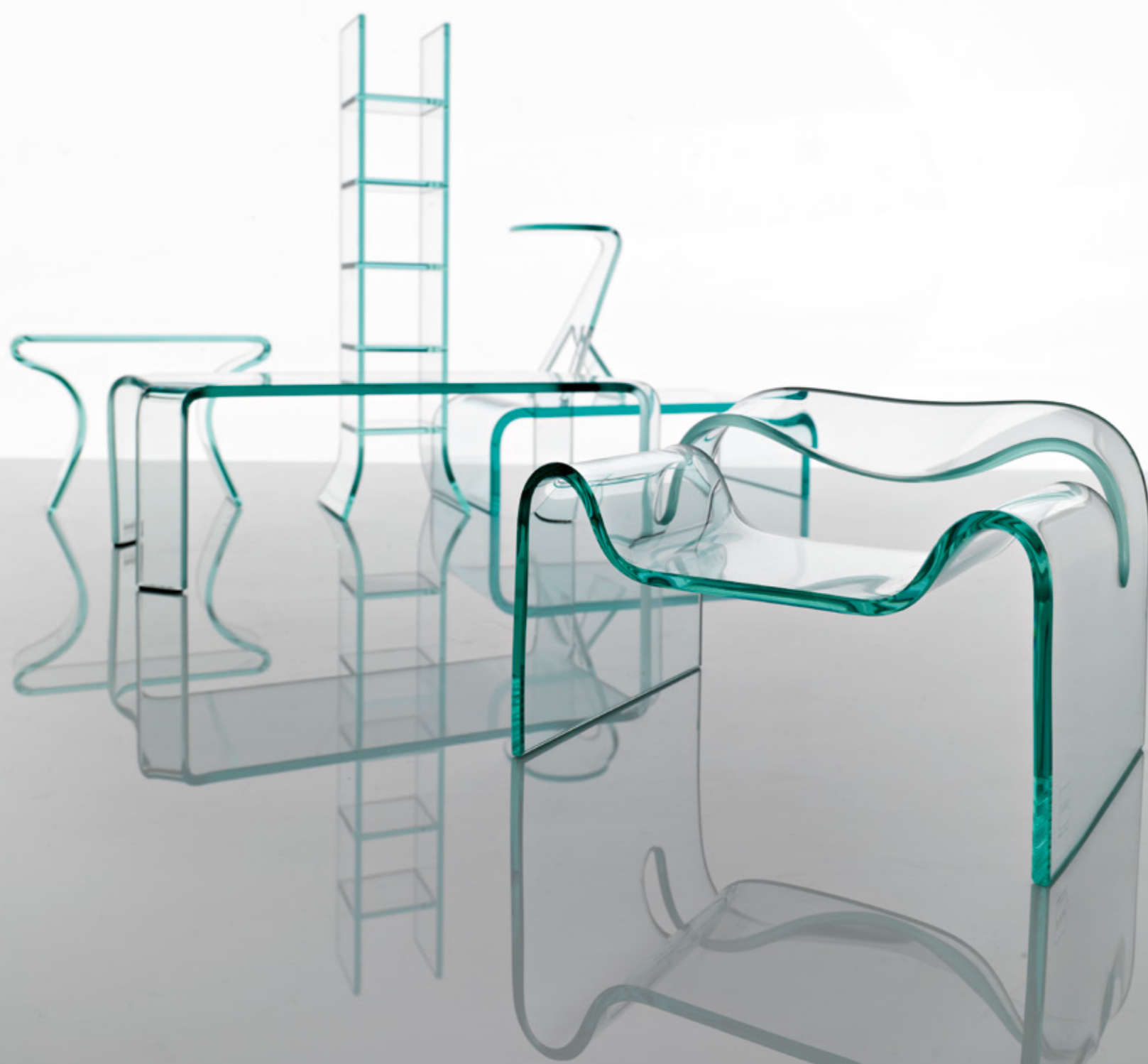

ADMIRAL



H 27 cm
ø 6 cm

BABELE



H 34 cm
L/W/L 9 cm
P/D/T 9 cm

MANTA



H 7 cm
L/W/L 23 cm
P/D/T 14 cm

CHARLOTTE



H 11 cm
L/W/L 17 cm
P/D/T 5,5 cm

COBRA



H 14 cm
L/W/L 7 cm
P/D/T 8,5 cm

GHOST



H 11 cm
L/W/L 17,5 cm
P/D/T 15,5 cm

GRILLO



H 12 cm
L/W/L 10,5 cm
P/D/T 8 cm

ALVAR AALTO



H 10,5 cm
ø 9 cm

PONTE



H 8 cm
L/W/L 26 cm
P/D/T 14 cm

RAGNO



H 10,5 cm
L/W/L 30,5 cm
P/D/T 16 cm



FIAM, garanzia di qualità

FIAM è certificata UNI EN ISO 9001:2008; la conformità a questa norma di riferimento permette a FIAM di raggiungere altissimi standard qualitativi. Una delle testimonianze dirette è la rintracciabilità dei suoi manufatti: ogni prodotto FIAM reca una decalcomania indelebile, cotta ad altissima temperatura, nella quale viene riportato oltre al marchio aziendale, un codice che permette di ricostruire il suo intero ciclo produttivo.

FIAM, garantie de qualité

FIAM est une entreprise certifiée UNI EN ISO 9001:2008; la conformité à cette norme de référence permet à FIAM d'atteindre des niveaux de qualité très élevés. La traçabilité des produits en est une preuve: chaque produit FIAM porte une décalcomanie indélébile, cuite à très haute température, qui mentionne la marque de l'entreprise et un code permettant de reconstruire tout son cycle de production.

FIAM, garantee of quality

Fiam is certified UNI EN ISO 9001:2008; the conformity to this reference norm allows Fiam to reach the highest quality standards. One of the direct evidences is the possibility to track of the products: a high temperature and therefore indelible decal is applied to every article, in addition to the company logo, this decal also bears a number of codes that allow the production cycle details of the article to be traced.

FIAM, eine Qualitätsgarantie

FIAM ist nach UNI EN ISO 9001:2008 zertifiziert und garantiert damit für höchste Qualitätsstandards. Dazu gehört auch die Nachverfolgbarkeit des Entstehungsweges der Erzeugnisse: Jedes FIAM-Produkt wird mit einem bei hohen Temperaturen eingebrannten Abziehbild versehen, auf dem neben dem Markenzeichen des Herstellers eine Identifikationsnummer steht, anhand der sich der gesamte Produktionszyklus des Artikels nachverfolgen lässt.

La garanzia del risultato: il controllo qualità.

Guaranteed flawless standards: quality control.
La garantie du résultat: le contrôle qualité.
Die Garantie für das Resultat – die Qualitätskontrolle.



art direction

copywriting
acanto comunicazione
(carlo piazzesi)

graphic design and layout
acanto comunicazione

rendering images
acanto comunicazione

photography and postproduction
studio amatibacciardi
studio leon

styling
monti studio
candida zanelli and serenella parri

coordination and logistics
daniele livi

selections
olimpia visual plan

print and packaging
grapho 5

credits

ALESSI
ALFRED DRAGO RENS - GALLERIA L'AFFICHE
AMINI CARPETS
APPLE
ARTEK
AXIL
SILVANO BACCIARDI
BAXTER
BOFFI
BPA INTERNATIONAL
BUSNELLI di Gruppo Industriale Busnelli
CAPPELLINI
CECILIA MARINO
CINOVA di Gruppo Industriale Busnelli
COHEN SEDGH TAPPETI
D3CO
DEDAR
DE PADOVA
DESALTO
EDD
ENTRATA LIBERA
FINN FORM PER ITTALA
FLOS
FLOU
GALLERIA ARTRA MILANO
GOLRAN
INCIPITLAB
JAB
LIVING DIVANI
DAVIDE LOVATTI
LUCEPLAN
MARTA FULVI
MARTINELLI LUCE
MOROSO
NANIMARQUINA
O LUCE
ORIZZONTI
PIANCA E OTTOEMEZZO
POLIFORM
RAW
RATTI BOUTIQUE
RINA MENARDI
ROMAGNOLI ARREDAMENTI PESARO
ROSENTHAL
SAMBONET
SANTAECOLE
SILVA TESSUTI
SONY ITALIA
VERY WOOD
VITRA

Fiam Italia
Via Ancona 1/b
61010 Tavullia (PU), Italia
Tel. 0039 0721 20051
Fax: 0039 0721 202432

www.fiamitalia.it
info@fiamitalia.it



fiamitalia.it

 www.facebook.com/fiamitalia