



Tonin

CASA

NEWS - SALONE DEL MOBILE 2024

100% MADE IN ITALY

Italian Artisan Beauty

La collezione Italian Artisan Beauty di Tonin Casa mette in luce e valorizza le eccellenze del territorio per qualità dei materiali, creatività e artigianalità. Una maestria artigianale da valorizzare e far conoscere a tutti i clienti Tonin Casa.

Tonin Casa's Italian Artisan Beauty collection highlights and enhances the area's excellence in material quality, creativity and craftsmanship. A craftsmanship to be enhanced and made known to all Tonin Casa customers.

TAVOLI / TABLES



ARCO MAXI 6



CUBE ROUND 10



OLIVER 14



STYLE ROUND EXT 18



THUNDER SILK WOOD 22

SEDUTE / CHAIRS



BUSTIER 26



HOLLYWOOD 28



GAIA 30

MADIE / SIDEBOARDS



APOGEO 32



MONOLITE EMPERADOR 34



OFF 36



PATSY 38



PATSY ÉLITE 40

CONSOLLE / CONSOLLE



ADONE PLISSÉ E ADONE PLISSÉ SILK WOOD 42



ARCO 44

SPECCHIERE / MIRRORS



ARKÉ 46



EDEN 48



GALILEO 50



PITTI 52

TAVOLINI / COFFEE TABLES



ATOLLO 54



GIUDECCA 56



IDDU 58



KONCA 60



SOFFIO 62



SOFFIO ÉLITE 64

LAMPADE / LAMPS



ANDROMEDA 66



BOLLA 68



LANTERNA 70



PETALO 72



VENICE MOON 74

LETTI / BEDS



ALIANTE 76



NAUTILUS 78

DIVANI / SOFAS



MONTECARLO 80

ACCESSORI / ACCESSORIES



INCONTRO A VENEZIA 84



VASI SOFFIO 86

arco maxi

design Angelo Tomaiuolo | Ernesto Barbieri

IT

Il tavolo Arco rinasce nella sua versione Maxi.
Due eleganti archi rivestiti in legno sorreggono l'ampio piano in vetro stampato, che mette in risalto le venature della preziosa finitura Crystal Calacatta.

EN

The Arco table is reborn in its Maxi version.
Two elegant wood-covered arches support the wide printed glass top, which highlights the veining of the precious Crystal Calacatta finish.

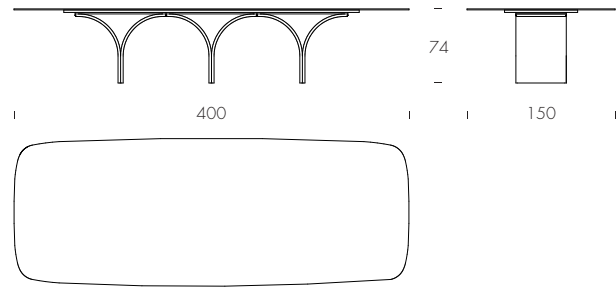

Arco Maxi _tavolo/table
base in noce canaletto,
top in gres Crystal Calacatta/
canaletto walnut base (0014),
Crystal Calacatta porcelain stoneware top (ST02).

Altri elementi:
sedie Lisa, madia Patsy Élite, lampada Petalo,
specchi Arké, lampade Venice Moon, vasi Soffio. /
Other items:
Lisa chairs, Patsy Élite sideboard, Petalo table lamp,
Arké mirrors, Venice Moon ceiling lamps, Soffio vases.



cube round

design Cristian Dal Bianco

IT

La famiglia di tavoli Cube si arricchisce con Cube Round, la versione con piano tondo, disponibile in vetro trasparente, vetro martellato, vetro ceramicato, gres e marmo.

EN

The Cube table family is enriched by Cube Round, the version with a round top, available in clear glass, hammered glass, ceramic glass, stoneware and marble.

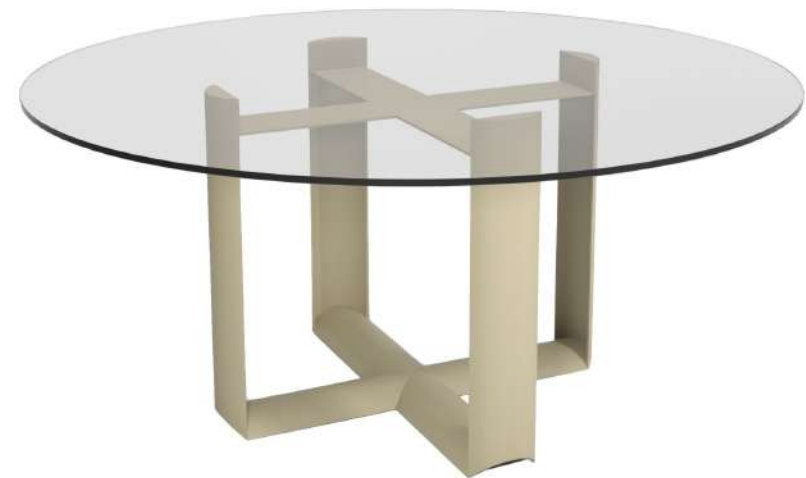
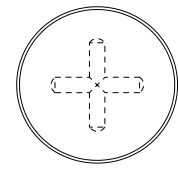
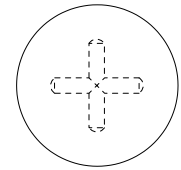
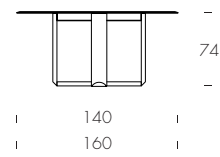
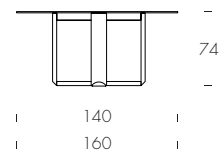



Cube Round _tavolo/table
base metallo verniciato Champagne opaco,
top in vetro martellato Bronzo/
matt Champagne powder coated base (I060),
Bronze hammered glass top (V83M).

Altri elementi: sedie Elmo/
Other items: Elmo chairs.

oliver

design Maurizio Varsi

IT

Il tavolo Oliver rappresenta la perfetta fusione architettonica tra materiali; il basamento, costituito da metallo verniciato e legno massello, sostiene un piano a botte in vetro o ceramica.

EN

The Oliver table represents the perfect architectural fusion of materials; the powder-coated metal and solid wood base supports a barrel top in glass or ceramic.

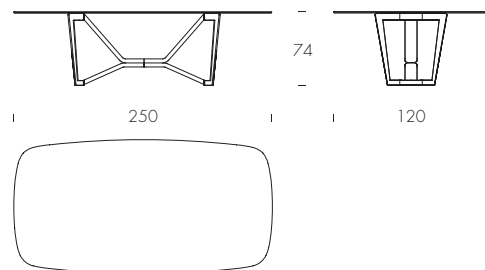



Oliver _tavolo/table

base in metallo Champagne e noce canaletto,
top in vetro extrachiaro trasparente bisellato/
Champagne powder coated metal and canaletto walnut base (0014).
Transparent extra clear beveled glass top (V100B).

Altri elementi:
sedie Mademoiselle, madia Patsy, lampade Lanterna, specchio Eden. /
Other items:
Mademoiselle chairs, Patsy sideboard, Lanterna lamps, Eden mirror.

style round ext

design Ernesto Barbieri | Marco Baraldi

IT

La famiglia di tavoli Style si arricchisce grazie a Style Round, il primo tavolo tondo allungabile; la base in acciaio verniciato è caratterizzata da incroci e sovrapposizioni, il top tondo in ceramica si contraddistingue grazie all'allunga rivestita in legno, perfettamente integrata al resto del piano.

EN

The Style family of tables is enriched with Style Round, the first extensible round table; the painted steel base features criss-crossing and overlapping, and the round ceramic top stands out thanks to the wood-covered extension, perfectly integrated with the rest of the top.

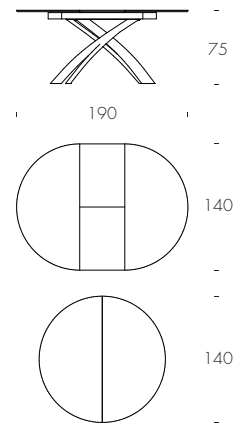



Style Round _tavolo/table
base metallo verniciato Grigio Carbone,
top in gres Alaska White/
Carbon Grey powder coated base (0010),
Alaska White porcelain stoneware top (V017P).

Altri elementi:
sedia Gaia, madia Ipogeo, specchio Decameron/
Other items:
Gaia chairs, Ipogeo sideboard, Decameron mirror.

thunder silk wood

design Maurizio Varsi

IT

La serie dei tavoli Thunder si arricchisce della versione con top in legno Silk Wood, finitura dall'effetto setoso che sorprende al tatto, resa ancora più particolare dal bisello perimetrale a sezione diamantata.

EN

The Thunder table series is enriched by the version with a top in Silk Wood, a finish with a silky effect that is surprising to the touch, made even more special by the perimeter bevel with diamond profile.

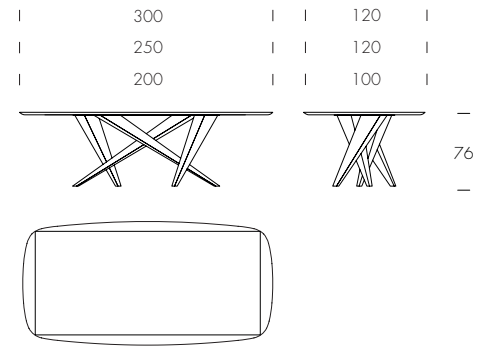



Thunder silk wood _tavola/table

base verniciato Grigio Carbone,
top in noce Canaletto effetto silk/
Carbon Grey powder coated base (0010),
Canaletto walnut silk effect top (S014).

Altri elementi:
sedie Bustier, madia Patsy, lampade Amphora, libreria Honeybook. /
Other items:
Bustier chairs, Amphora lamps, Honeybook bookshelf.



bustier

design Ernesto Barbieri

IT

Sedia con struttura in metallo verniciato, rivestimento in tessuto, pelle, ecopelle o velluto, come da campionario. Retroschiena con trapuntatura "bustier".

EN

Chair with lacquered metal structure, upholstered in fabric, leather, faux leather or velvet as supplied by the samples. Backrest with bustier stitching.

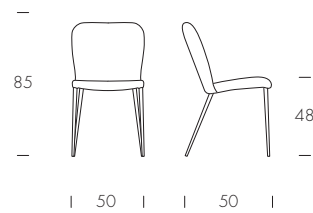

Bustier sedia/ chair
base verniciato Grigio Carbone,
rivestimento in Pelle Grigio Gabbiano/
Carbon Grey powder coated base (0010),
Gull Grey leather upholstery (P_29).

Altri elementi: lampada Breath. /
Other items: Breath lamp.

hollywood

design Ernesto Barbieri

IT

Seduta con scocca in legno curvato, cuscino imbottito in cuoio e gambe in metallo, legno o girevole a 4 razze.

EN

Chair with wooden curved seat, thick leather cushion and metal, wooden or 4-spoke swivel base.

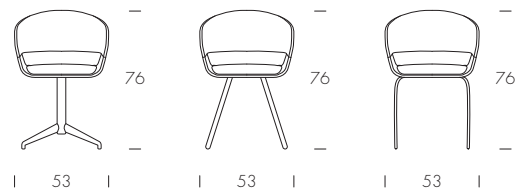

Hollywood_sedia/chair
base verniciato Nero,
scocca in frassino nero con cuscino cuoio Beige /
Black varnished base (0002),
Black ash seat (0025) with Beige thick leather cushion.

gaia

design Ernesto Barbieri

IT

Confort e naturalezza sono le caratteristiche peculiari della seduta Gaia, resa avvolgente ed accogliente grazie alla generosa imbottitura e ai braccioli. Le gambe in metallo conferiscono leggerezza ed eleganza.

EN

Comfort and naturalness are the hallmarks of the Gaia seat, made enveloping and cosy by the generous upholstery and the armrests. The metal legs add lightness and elegance.

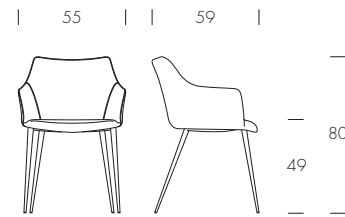

Gaia_sedia / chair
base verniciato Grigio Carbone,
seduta rivestita in tessuto Bouclé Bianco Avana /
Carbon Grey powder coated base (0010),
upholstered in Havana White Bouclé fabric (TB908).

apogeo

design Massimo Mottin | Ernesto Barbieri

IT

Realizzata con materiali di alta qualità e con una minuziosa cura artigianale, la madia Apogeo combina la struttura in frassino con la solidità e l'eleganza delle ante in marmo lavorato su disegno geometrico, rappresentando il connubio perfetto tra natura e design.

EN

Made with high-quality materials and meticulous craftsmanship, the Apogeo sideboard combines an ash frame with the solidity and elegance of geometrically worked marble doors, representing the perfect marriage of nature and design.

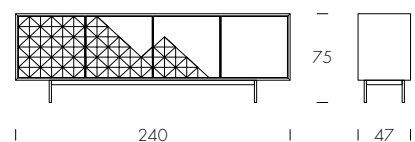

Apogeo_madia/sideboard
base verniciato Grigio Carbone, struttura in frassino nero,
frontali in marmo Grigio Carnico /
Carbon Grey powder coated base (0010), black ash structure (0025)
Carnic Grey marble doors

monolite emperador

design Massimo Mottin | Ernesto Barbieri

IT

Madia contenitore a quattro ante completamente rivestite esternamente con pellicola di riproduzione marmorea Emperador, applicata con tecnologia post-forming e laccata lucida 100 gloss.

EN

Four-door storage unit, completely covered on the outside with Emperador marble reproduction film, applied using the post-forming technique and finished with a 100 gloss lacquer.

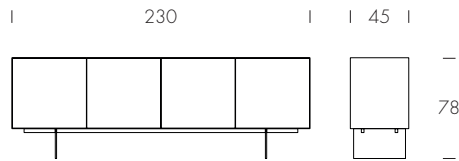

Monolite emperador_madia/sideboard
base verniciato Bronzo Pietra,
struttura e frontali riproduzione marmorea applicata Emperador /
Stone Bronze powder coated base (0083),
Emperador marble effect applied structure and doors.

Altri elementi: specchio Pitti. /
Other items: Pitti Mirror.

IT

Grazie alla combinazione di legno laccato e vetro, la madia Off conferisce all'ambiente luminosità ed eleganza; il vetro fuso retroargentato crea un gioco di luci e riflessi che esaltano la preziosità del materiale e delle lavorazioni.

EN

Thanks to the combination of lacquered wood and glass, the Off sideboard gives the room brightness and elegance; the back-silvered fused glass creates a play of light and reflections that enhance the preciousness of the material and workmanship.

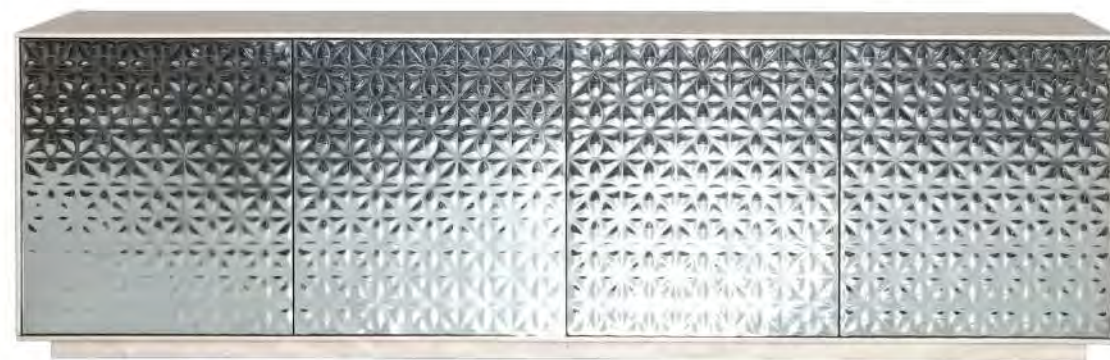
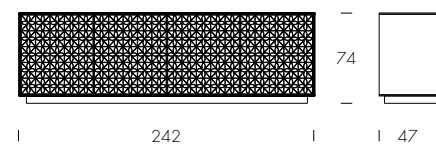
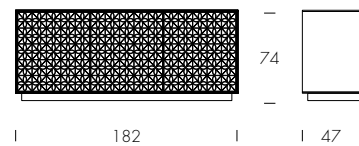

Off_madia/sideboard
 struttura laccato Champagne opaco,
 ante in vetro fuso retro-argentato - finitura bronzo /
 matt Champagne lacquered structure (0060),
 Silver retro-lacquered cast glass - bronze finish doors (0054).

Altri elementi: specchio Dorian. /
 Other items: Dorian Mirror.



patsy

design Massimo Mottin | Ernesto Barbiere

IT

Patsy è un'elegante madia in legno laccato, caratterizzata da fessature orizzontali che si ripetono su fianchi ed ante. Il top è disponibile anche in specchio bronzato.

EN

Patsy is an elegant lacquered wood sideboard, characterized by horizontal millings that are repeated on the sides and doors. The top is also available in bronzed mirror.

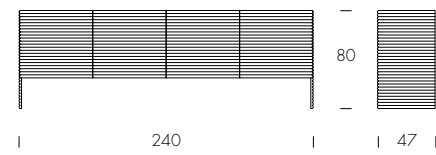
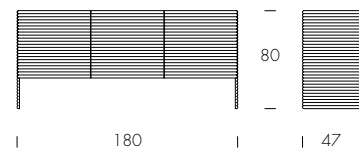

Patsy madia/ sideboard
struttura laccato Beige opaco /
matte beige lacquered structure (S036)

Altri elementi: tavolini Iddu. /
Other items: Iddu coffee tables

patsy élite

design Massimo Mottin | Ernesto Barbieri

IT

Patsy è un'elegante madia in legno laccato, caratterizzata da fresature orizzontali che si ripetono su fianchi ed ante. Il top è disponibile anche in specchio bronzato.

EN

Patsy is an elegant lacquered wood sideboard, characterized by horizontal millings that are repeated on the sides and doors. The top is also available in bronzed mirror.

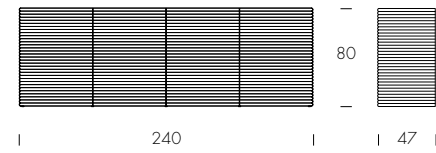
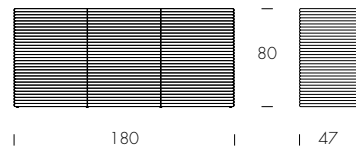

Patsy Élite_madia/sideboard
struttura laccato Champagne opaco /
matt Champagne lacquered structure.

Altri elementi: specchi Arké, lampada Petalo. /
Other items: Arké mirrors, Petalo lamp.

adone plissé e adone plissé silk wood

design Luca Roccadadria | Ernesto Barbieri

IT

Il basamento in vetro bocciardato finemente lavorato con trama plissettata crea riverberi di luce che, insieme al top leggero in ceramica o al top in legno a sezione diamantata per la versione Silk Wood, rendono la consolle Adone Plissé un elemento d'arredo elegante e dinamico.

EN

The finely crafted, bush-hammered, pleated glass base, together with the light ceramic top or the diamond-cut wood top for the Silk Wood version, create an elegant and dynamic piece of furniture.

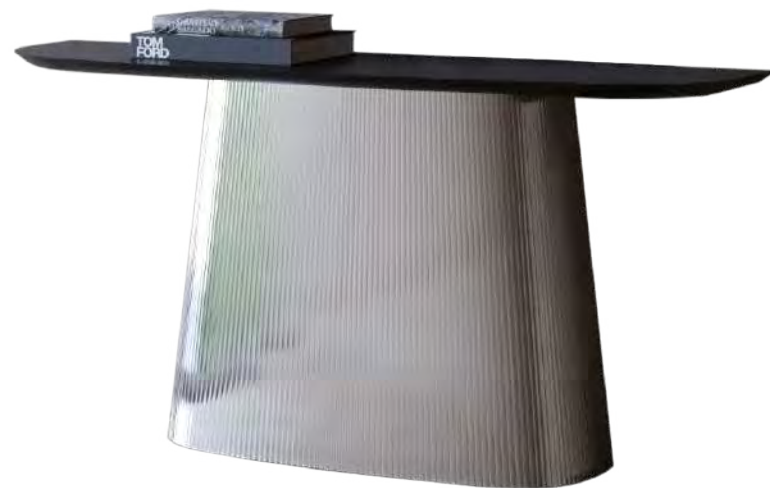
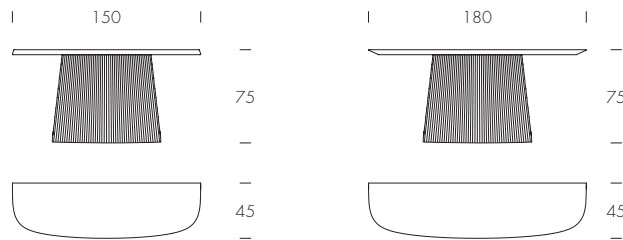

Adone Plissé_console/console
base vetro plissettato bronzo, top in noce canaletto. /
pleated bronze glass base (VP83), canaletto walnut top (0014).

Altri elementi: specchio Diamante, frsgranza Incontro a Venezia. /
Other items: Diamante mirrors, Incontro a Venezia home fragrance.

arco

design Angelo Tomaiuolo

IT

La consolle Arco è caratterizzata da una leggera struttura curvata rivestita in legno e da un top in gres; perfetta per essere utilizzata come piano d'appoggio per oggetti decorativi o come base per una lampada, è abbinabile all'omonimo tavolo.

EN

The Arco console features a light curved wood-covered frame and a stoneware top; perfect for use as a tabletop for decorative objects or as a base for a lamp, it can be combined with the table of the same name.

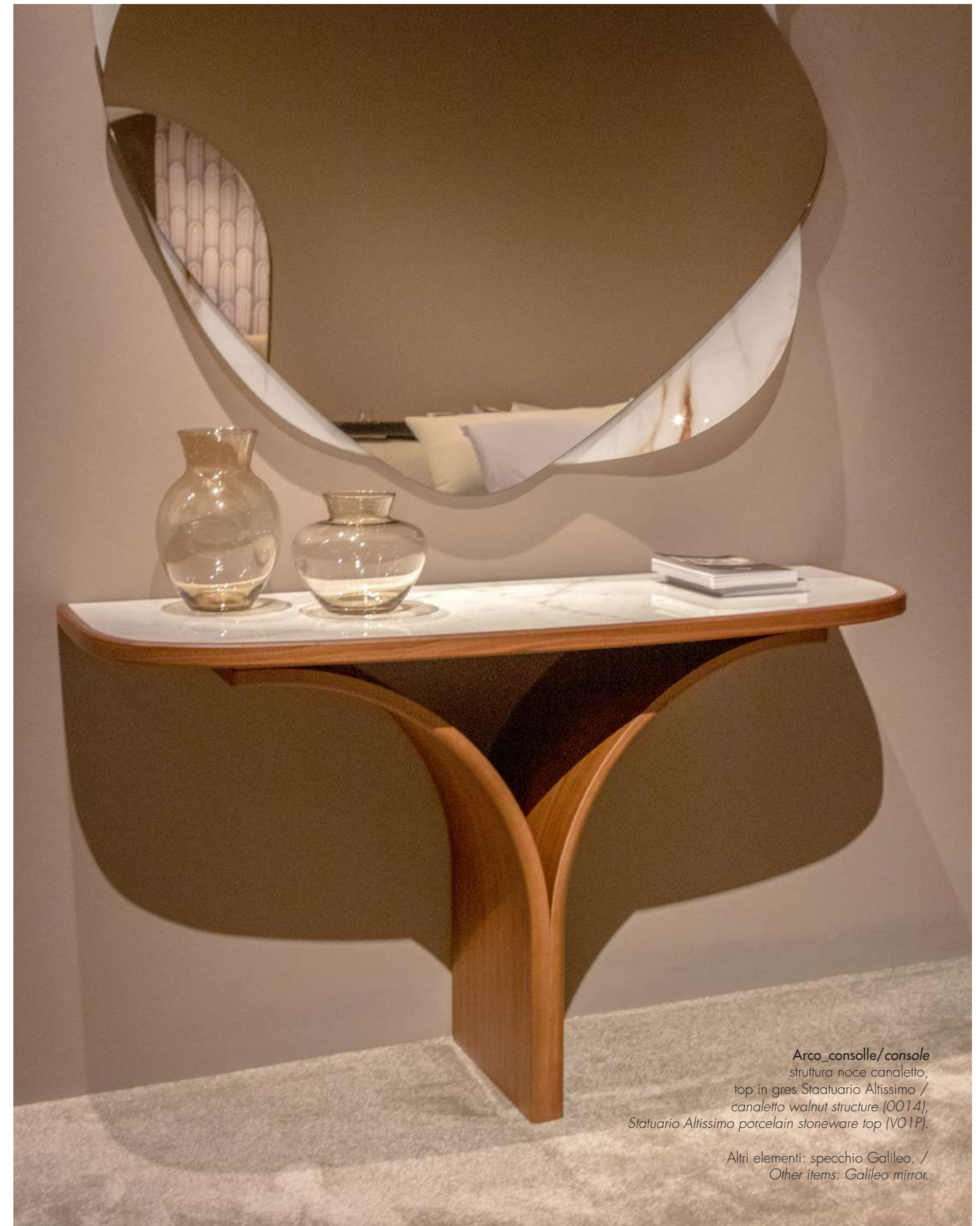
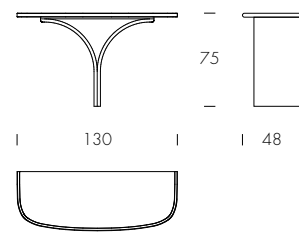

Arco_console/console
struttura noce canaletto,
top in gres Statuario Altissimo /
canaletto walnut structure (0014),
Statuario Altissimo porcelain stoneware top (V01P).

Altri elementi: specchio Galileo. /
Other items: Galileo mirror.

arké

design Angelo Tomaiuolo

IT

Il design moderno e raffinato della specchiera da parete Arkè, con inserto laterale in ceramica, offre personalità e stile all'ambiente, oltre che donare luce e allargare otticamente gli spazi.

EN

The modern and refined design of the Arkè wall mirror, with ceramic side insert, offers personality and style to the room, as well as giving light and optically enlarging the space.

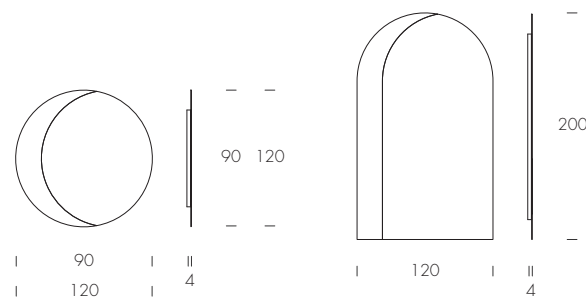

Arké specchio/mirror
specchio argentato, inserto in Crystal Calacatta /
silver mirror (VO45), Crystal Calacatta digital print (STO2)

Altri elementi: servomuto Mirò. /
Other items: Mirò valet stand.

eden

design Luca Roccadadria

IT

Il gioco di riflessioni delle forme curve caratterizzano l'elegante sagoma dello specchio Eden, disponibile in due diverse forme e dimensioni, nelle finiture bronzo e fumé.

EN

Available in two different shapes, sizes and finishes - bronze and fumé -, the elegant outline of the Eden mirror is characterised by a play of reflections and curved shapes.

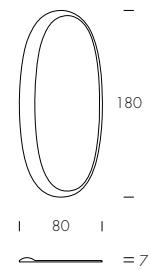
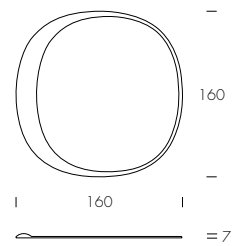

Eden_specchio/mirror
specchio bronzo./
bronze mirror (V184).

Altri elementi: sedia Hollywood /
Other items: Hollywood chair.

galileo

design Luca Roccadadria | Ernesto Barbieri

IT

Galileo è una specchiera curva-
ta con stampa digitale e spec-
chio centrale, che grazie al suo
particolare design, può essere il
punto focale di qualsiasi stanza.

EN

Galileo is a curved mirror with a
digital print and a central mirror
that, thanks to its special design,
can be the focal point of any
room.

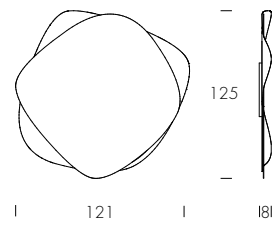

Galileo_specchio/mirror
specchio bronzo, inserto Crystal Calacatta./
bronze mirror (V184), Crystal Calacatta digital print (ST02).

Altri elementi: consolle Arco /
Other items: Arco console.

IT

Specchio tondo con cornice in fusione goccia: con le sue delicate linee dai motivi geometrici, Pitti dona un fascino raffinato ad ogni tipo di spazio living.

EN

Round mirror with a droplet cast frame: with its delicate lines with geometric patterns, Pitti gives refined charm to any type of living space.

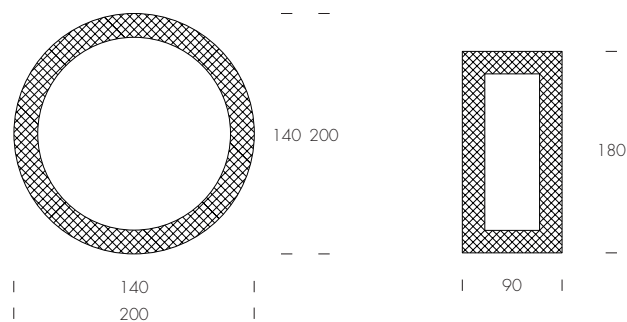

Pitti_specchio/mirror
specchio fumé / fumé mirror (VS87)

Altri elementi: madia Monolite Emperador, sedia Elmo /
Other items: Monolite Emperador sideboard, Elmo chair

atollo

design Andrea Andretta Studio

IT

Coppia di tavolini in vetro verniciato. Realizzati con materiali di alta qualità, i tavolini Atollo si caratterizzano per la particolare superficie martellata disponibile in due colorazioni differenti. La superficie lucida del vetro riflette la luce ambientale, amplificandola e creando un'atmosfera luminosa e accogliente.

EN

Pair of coffee tables in lacquered glass. Made from high quality materials, the Atollo coffee tables feature a special hammered finish, available in two different colours. The polished surface of the glass reflects and amplifies ambient light, creating a bright and welcoming atmosphere.

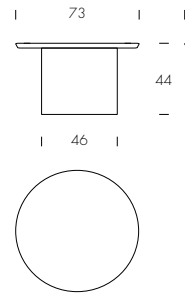
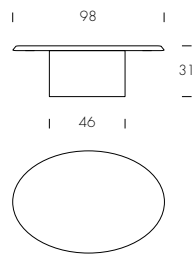

Atollo tavolini / coffee tables
specchio bronzo, inserto Crystal Calacatta /
bronze mirror (V184), Crystal Calacatta digital print (ST02)

Altri elementi: consolle Arco /
Other items: Arco console.

giudecca

design Massimo Mottin | Ernesto Barbieri

IT

Dall'aspetto leggero e delicato i tavolini Giudecca sono complementi d'arredo in vetro soffiato a bocca ideali per uno stile moderno ed elegante; disponibili in colorazione ambra e fumé, sono declinabili sia come tavolini che come servetti. Il vetro colorato rende possibili innumerevoli giochi di luce grazie a trasparenze e riflessi. Il basamento è in legno laccato nero opaco.

EN

With a light and delicate design, Giudecca mouth-blown side tables are ideal furnishing complements for a modern and elegant style; available in amber and fumé glass, they can be declined both as side tables and as servants. The colored glass makes possible countless plays of light thanks to transparencies and reflections. The base is in matt black lacquered wood.

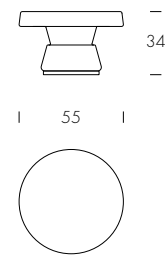
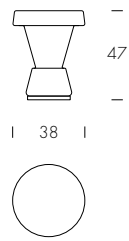

Giudecca_tavolini/coffee tables
vetro ambra./
amber glass (V055).

iddu

design Massimo Mottin | Ernesto Barbieri

IT

Dallo stile lineare ed essenziale, i tavolini Iddu sono costituiti da due forme semplici sovrapposte: la base a tronco di cono in metallo verniciato a supporto del vassoio tondo in finitura. Il piano è arricchibile con dei top opzionali ad incasso in gres.

EN

Linear and essential in style, Iddu coffee tables are made of two simple shapes placed one on top of the other: the truncated cone base in powder-coated metal, supports the round tray in the same finish. The top can be enriched with optional recessed stoneware tops.

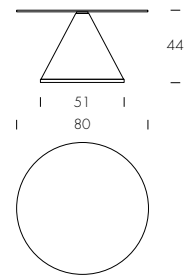
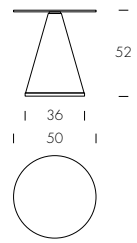

Iddu_tavolini / coffee tables
struttura Bronzo Pietra e Grigio Carbone,
top in gres Alaska White e gres Orobico Chic. /
Stone Bronze and Carbon Grey structure (0083, 0010),
Alaska White and Orobico Chic porcelain stoneware (V017P, V018P).



konca

design Massimo Mottin | Ernesto Barbieri

IT

Konca è un tavolino dalle forme morbide, realizzato in vetro soffiato a bocca; il piano riproduce l'effetto delle increspature dell'acqua. Disponibile in due dimensioni e due colorazioni differenti per creare il perfetto mix adattabile ad ogni contesto domestico. Il basamento è in legno laccato nero opaco.

EN

Konca is a softly shaped coffee table made of mouth-blown glass; the top reminds of water ripples effect. Available in two different sizes and colors to create the perfect mix adaptable to any home setting. The base is in matt black lacquered wood.

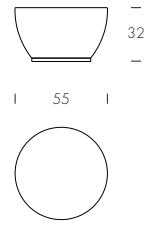
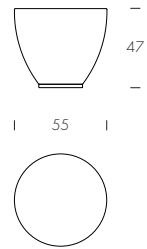

Konca_tavolini/coffee tables
vetro verde pavone./
peacock green glass (V057).

soffio

design Massimo Mottin | Ernesto Barbieri

IT

Soffio è una coppia tavolini in vetro soffiato artistico veneziano plissettato, con base in legno laccato nero opaco.

EN

Soffio is a pair of Venetian blown glass coffee tables with a matt black lacquered wooden base.

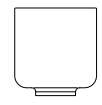

| 41 |

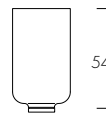
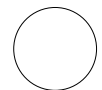

| 30 |

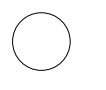

Soffio_tavolini/coffee tables
vetro fumé trasparente /
transparent fumé glass (V0085).

soffio élite

design Massimo Mottin | Ernesto Barbieri

IT

Tavolini in vetro artistico veneziano soffiati a bocca, con effetto plissettato sulla superficie; arricchiti da eleganti top rotondi con bordo inclinato, rivestiti in frassino spazzolato.

EN

Coffee tables in mouth-blown Venetian glass with a pleated effect on the surface, enriched with elegant round tops with bevelled edges, covered with brushed ash.

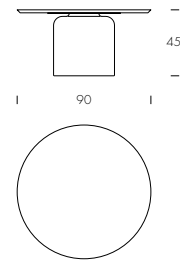
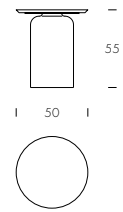

Soffio Élite_tavolini / coffee tables
vetro verde oliva, top in frassino nero.
Olive green glass (V0015), black ash top (0025).

Altri elementi: fragranza d'ambiente Incontro a Venezia. /
Other items: Incontro a Venezia home fragrance.

andromeda

design Tonin Casa Creatives

IT

La lampada a sospensione Andromeda, con configurazioni da 1 a 15 sfere ellittiche in vetro fumé, conferisce unicità volumetrica e dinamicità allo spazio che illumina.

EN

Andromeda ceiling lamp, with configurations of 1 to 15 fumé glass elliptical bulbs, adds volumetric uniqueness and dynamism to the space it illuminates.

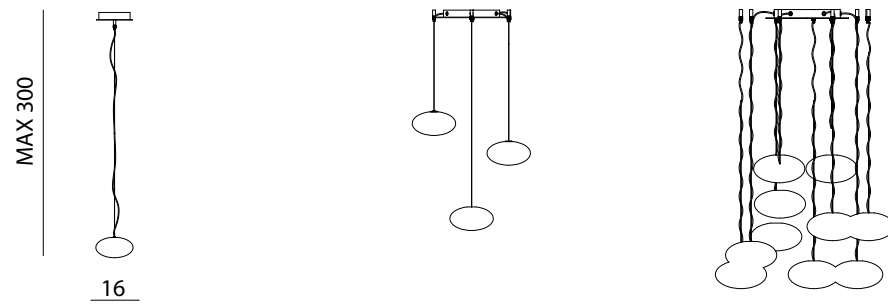

Andromeda_lampada/lamp
vetro trasparente fumé./
fumé transparent glass (VO85).

Altri elementi: specchio Decameron. /
Other items: Decameron mirror.

bolla

design Massimo Mottin | Ernesto Barbieri

IT

Preziosa nella sua semplicità, Bolla è una lampada che mette in risalto l'artigianalità della lavorazione del vetro soffiato veneziano, in un'elegante finitura fumé.

EN

Precious in its simplicity, Bolla is a lamp that highlights the craftsmanship of Venetian blown glass making in an elegant fumé finish.

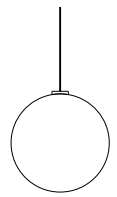

| 50 |

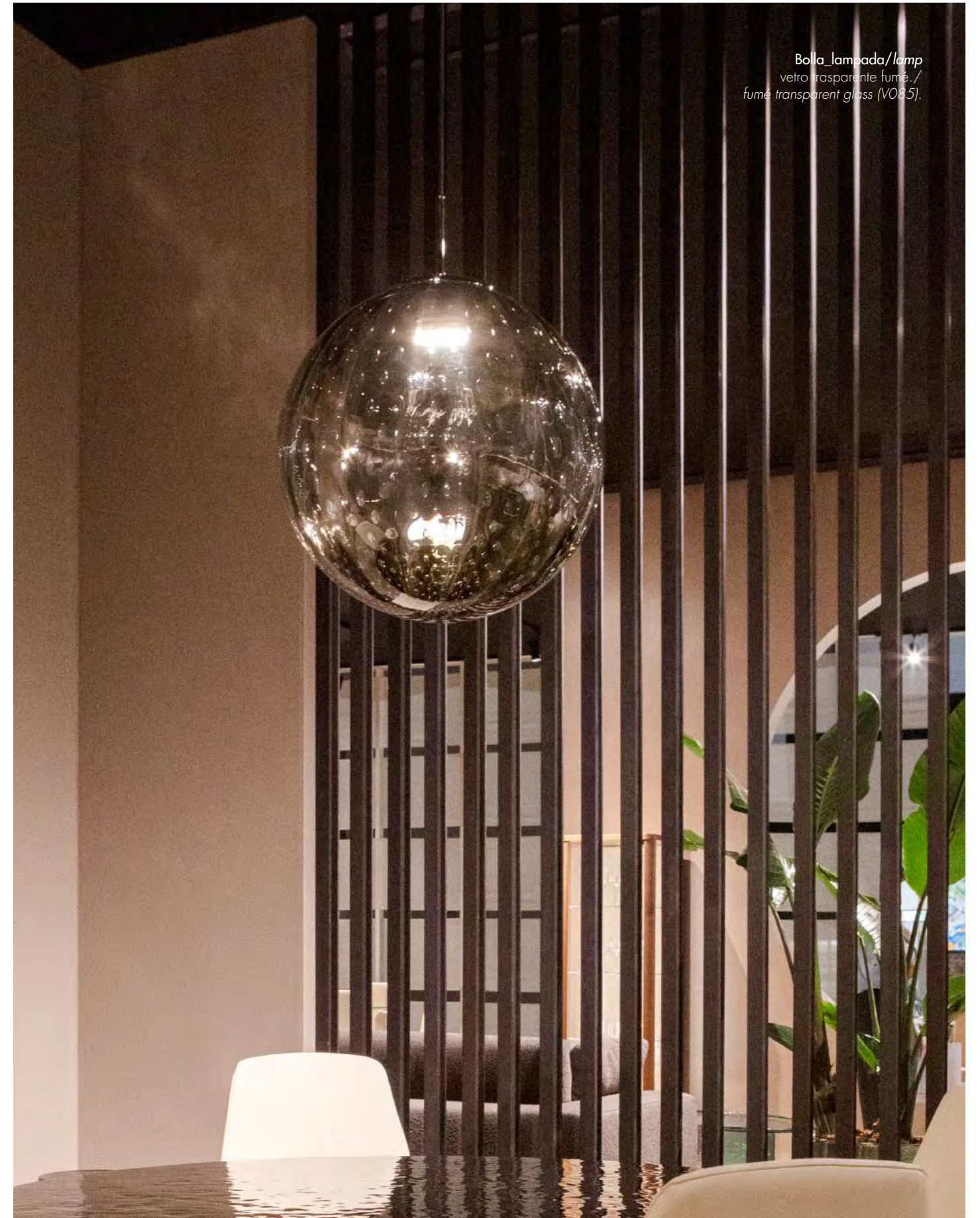

Bolla_lampada/lamp
vetro trasparente fumé./
fumé transparent glass (VO85).

lanterna

design Ernesto Barbiere

IT

La lampada Lanterna è caratterizzata dalla lavorazione tridimensionale a rombi del vetro fumé soffiato a bocca; l'effetto trapuntato dà vita a giochi di luci e riflessi, rendendo l'ambiente sofisticato ed affascinante. Disponibile nella versione a sospensione o da tavolo.

EN

Lantern lamp is characterised by the three-dimensional, rhombus-shaped mouth-blown fumé glass; the quilted effect creates a play of light and reflections, making the environment sophisticated and fascinating. Available in ceiling and table versions.

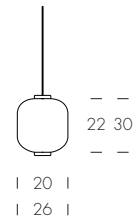

Lantern_lampada/lamp
vetro trasparente fumé./
fumé transparent glass (V085).

Altri elementi: specchio Eden, vasi Primitivi. /
Other items: Eden mirror, Primitivi vases.

petalo

design Tonin Casa Creatives

IT

Lampada da tavolo in vetro veneziano, lavorata a mano. La sua forma organica ricorda una fioritura; i suoi elementi inseriti in maniera concentrica, creano insieme alla luce effetti di trasparenze e sfumature, che danno origine ad un'atmosfera soffusa e rilassata.

EN

Handmade Venetian glass table lamp. Its organic shape is suggested by a flower; its concentric elements create effects of transparency and shading with the light, creating a soft, relaxed atmosphere.

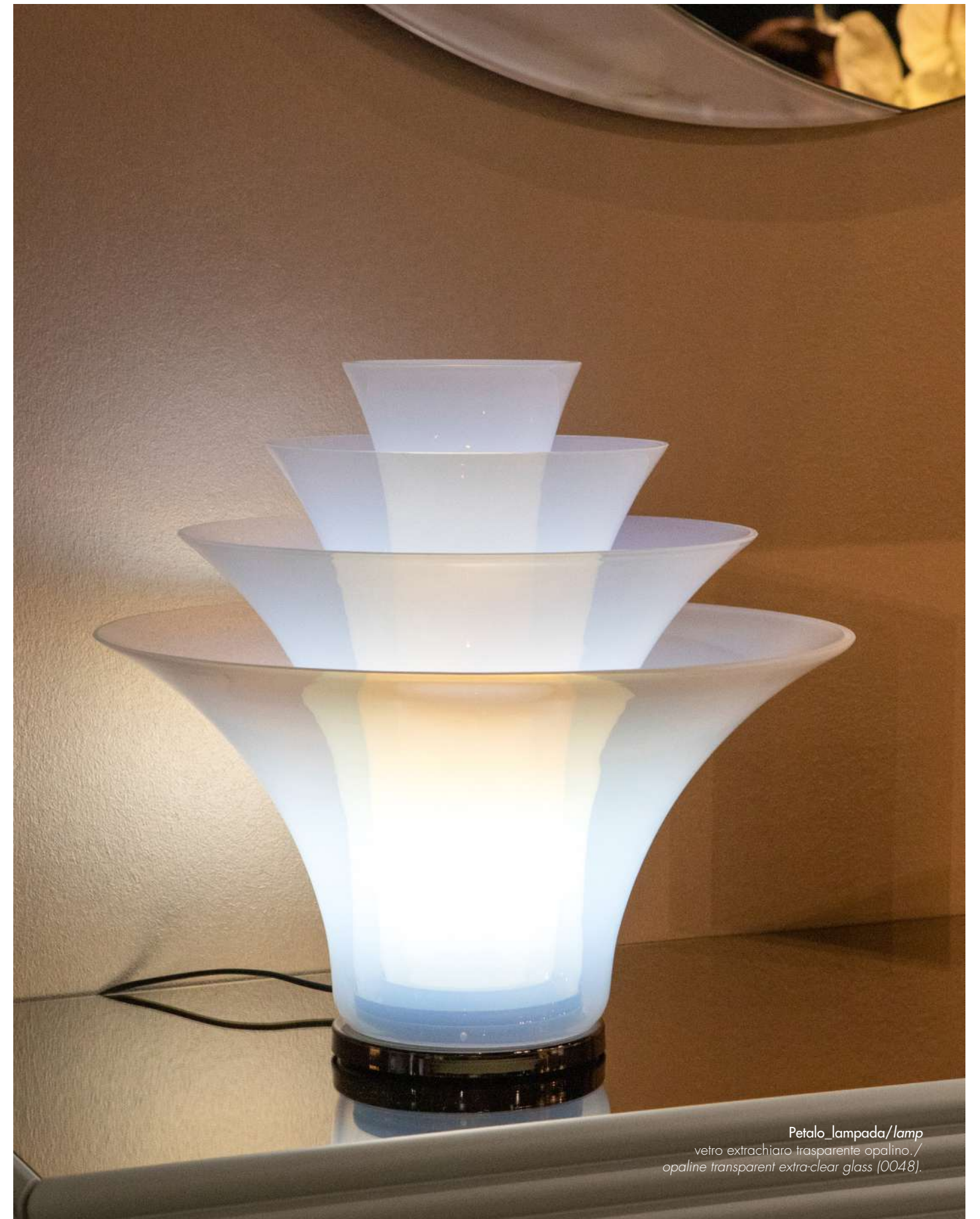
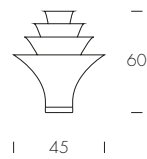

Petalo_lampada/lamp
vetro extrachiara trasparente opalino /
opaline transparent extra-clear glass (0048).

venice moon

design Massimo Mottin | Ernesto Barbieri

IT

Come a voler rievocare una luna luminosa che brilla sui canali veneziani, la lampada Venice Moon con il suo vetro opalino soffiato a bocca dona ad ogni ambiente un'atmosfera magica e sognante. Ogni esemplare è il simbolo di quella che è la creatività e l'artigianalità della tradizione veneziana.

EN

Like a bright moon shining over the Venetian canals, the Venice Moon Lamp, with its mouth-blown opaline glass, creates a magical, dreamy atmosphere in any room. Each piece is a symbol of the creativity and craftsmanship of the Venetian tradition.

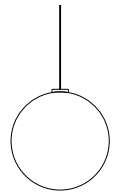

| 50 |



Venice Moon_lampada/lamp
vetro bianco opalino./
white opaline glass (0048).

Altri elementi: specchio Arké. /
Other items: Arké mirror.



aliente

design Maurizio Varsi

IT

Realizzato con materiali di alta qualità e design ergonomico, questo letto è perfetto per chi cerca comfort e stile contemporaneo. Caratterizzato dalla testiera formata da cuscini strutturali, possiede anche una pratica mensola in legno massello che permette di tenere a portata di mano libri, sveglie o qualsiasi altro oggetto.

EN

Made of high-quality materials and ergonomic design, this bed is perfect for those seeking comfort and contemporary style. Featuring a headboard formed of structural pillows, it also has a practical shelf in solid wood that allows to keep books, alarm clocks or any other items within easy reach.

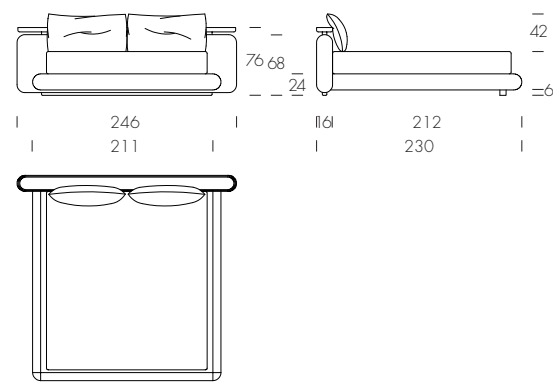

Aliante letto/bed
rivestimento in tessuto Bouclé Bianco, mensola in frassino nero. /
White Bouclé fabric upholstery (TB908), black ash shelf (0025).
Altri elementi: tappeto Raku, lampada Atomo, poltrona Mama. /
Other items: Raku rug, Atomo lamp, Mama armchair.

nautilus

design Maurizio Varsi

IT

Nautilus è un letto matrimoniale dal design moderno e deciso, caratterizzato da una base in legno massello con geometrie definite arricchita da una testiera rivestita in tessuto, pelle o ecopelle.

EN

Nautilus is a double bed with a bold modern design, featuring a solid wood base with defined geometries enriched by a headboard covered in fabric, leather or eco-leather.

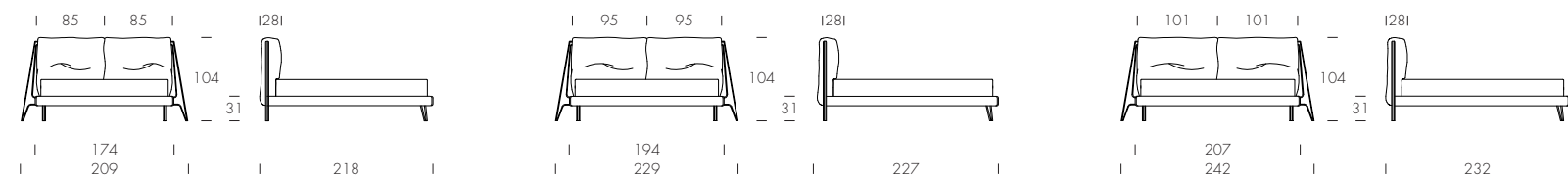

montecarlo

design Maurizio Varsi

IT

Montecarlo è un divano componibile, rivestito in tessuto o pelle, che si adatta ad ogni living dallo stile moderno, aggiungendo un tocco di dinamismo grazie alle linee inclinate della base.

EN

Montecarlo is a modular sofa, upholstered in fabric or leather, that fits into any living room with a modern style, adding a touch of dynamism thanks to the sloping lines of the base.

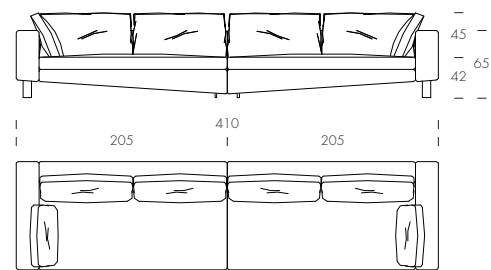
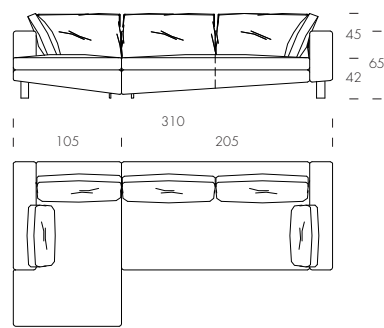
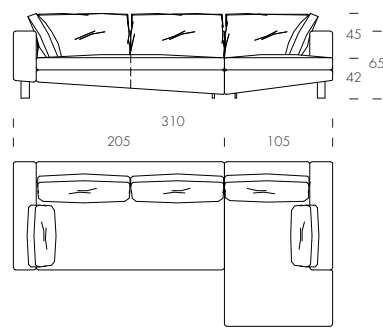

Montecarlo_divano/sofa
rivestimento in tessuto Bouclé Grigio./
Grey Bouclé fabric upholstery (TB_101).

Altri elementi: tavolini Atollo, tappeto Raku. /
Other items: Atollo coffee tables, Raku rug.



Montecarlo divano/sofa
rivestimento in tessuto Bouclé Grigio.
Grey Bouclé fabric upholstery (TB_101).

Altri elementi: tavolini Atollo, tappeto Raku.
Other items: Atollo coffee tables, Raku rug.

incontro a venezia

design Persentio | Tonin Casa Creatives

IT

Il profumo dei legni pregiati provenienti dal lontano oriente si fonde con gli agrumi mediterranei pronti per raggiungere l'altro lato del mondo. Questa profumo d'ambiente è una fusione di fragranze dalle note di testa del bergamotto e del limone, passando al cuore ai fiori d'arancio, con un fondo al pino, patchouli e legni ambrati.

EN

The scent of precious woods from the Far East meets Mediterranean citrus, ready to reach the other side of the world. This home fragrance is a fusion of fragrances, from the top notes of bergamot and lemon to the heart of orange blossom, with a base of pine, patchouli and amber woods.



vasi soffio

design Massimo Mottin | Ernesto Barbieri

IT

I vasi Soffio, con la caratteristica struttura in vetro plissettato, vanno a completare la famiglia di tavolini omonimi.

EN

The Soffio coffee table family is completed by the Soffio vases with their characteristic pleated glass structure.

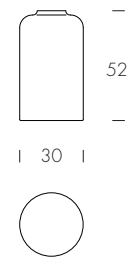
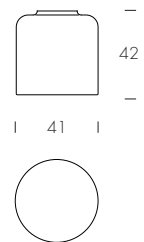

IT

Tonin Casa si riserva di apportare, senza preavviso, modifiche nei materiali, nei rivestimenti, nelle finiture e nei disegni dei prodotti presentati in questo catalogo. Le texture e i colori dei materiali e delle finiture hanno valore indicativo in quanto soggetti alle tolleranze dei processi di stampa.

È vietata ogni riproduzione totale e parziale in Italia e all'estero.

EN

Tonin Casa reserves the right to change, without previous notice, materials, covers, finishes and drawings of the products presented in this catalogue. The textures and colours of materials and finishes are indicative as they are depending on the tolerances of the printing process.

Total or partial reproduction of the products is prohibited in Italy and abroad.

RU

Tonin Casa оставляет за собой право, без каких-либо предупреждений, вносить изменения в используемые материалы, обивки, отделки и изображения продукции, представленной в данном каталоге.

Текстура и цвета материалов и отделок имеют ориентировочный характер, так как могут варьироваться в процессе печати.

ES

Tonin Casa se reserva el derecho de aportar modificaciones de dibujo, materiales, acabados y tapicerías, sin que esté obligada a dar aviso anticipado. Las texturas y los colores de los materiales y de los acabados tienen solo un valor indicativo porque están sujetos a la tolerancia en los procesos de imprenta.

Prohibida la reproducción total o parcial en Italia y en el extranjero.

FR

Tonin Casa se réserve le droit d'apporter, sans préavis, des modifications au niveau des matériaux, des revêtements, des finitions et du design des produits présentés dans ce catalogue. Les textures et les couleurs des matériaux et des finitions sont une valeurs indicative parce que ils changent selon la tolérance aux procédés d'imprimerie.

La reproduction, totale ou partielle, est interdite, que ce soit en Italie ou à l'étranger.

progetto
design

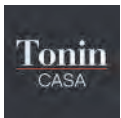

Tonin Casa is a brand of
Progetto Design International srl

via Guglielmo Marconi, 37
35010 San Pietro in Gu (PD), Italy

t +39 049 9453300
f +39 049 9450725

info@tonincasa.it
c.f. P.iva IT03817150240

*COPYRIGHT © Progetto Design International srl
Tutti i diritti riservati - All rights reserved*