

.collection
2023 | 2024

Tonin

CASA

Tonin

CASA

index

tavoli
tables



adone 010



adone plissé 014



arco 018



blade plus 022



branch 026



eliseo brushed 032



italo 038



panta rei 042



pois elite 046



reverse artistic glass 050



reverse mini 054



tenso orione couture 056



thunder 060



zeno 062

sedute
seats



bea 068



bea plus 070



cleo 072



dafne 074



dafne swivel 076



dauphine 078



elmo 080



lisa 082



lisa cuoio 084



mademoiselle 086



olympia 090



spillo 094



tender 096



zoe 098

sgabelli
stools



cleo 102



olympia 104



olympia xl 104

divani
sofas



cleto 108



london 112



milo 118

index

poltrone
armchairs



capriccio 116



milo 118



tender lounge 122

programmi
e madie
systems &
sideboards



aira wood 126



all star 130



anemos 134



beyond 138



bombè 142



coated 146



kintsugi 150



magma 154



millebolle 158



monolite 162



passepartout 166



pizzo 168



rock 172



stripes 176

vetrine e
librerie
showcases
& bookcases



ego 182



ego round 184



ego plus 186



icon 188



oasi 190

consolle
consoles



adone 196



tea 198

specchiere
mirrors



orologio anemos 202



decameron 204



diamante 206



dorian 208



hive 214



kaleidos 216



moma 218



pitti 220

index



rock 222



vinci 224

complementi occasional furniture



arturo 228



duals 232



dubai 234



magellano 236



oasi 238



ocean 240



ponti 244



skyline 246

lampade lamps



amphora 252



chic 254



chic 254



pagoda 258



pagoda 258



pagoda 258

letti e gruppinotte beds & night groups



all star night 264



callisto 266



dan 268



ginger 272

tappeti rugs



essence 276



gea 278

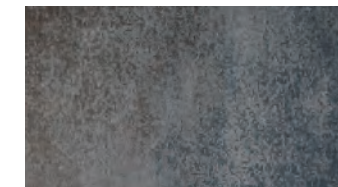

pixel 280



vintage 282

oggettistica objects



botanika 286



chimera 288



futurism 290



pot 292



primitivi 294

carta da parati wallpapers



cathedral 298

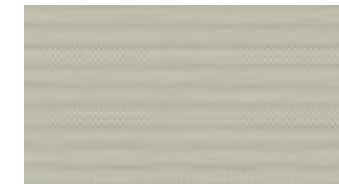

helm 298

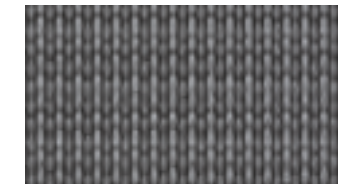

sesto acuto 299



tides 299

adone

E. Barbieri | M. Mottin | 2023

Ogni ambiente riluce di straordinaria bellezza con Adone, tavolo che unisce all'estetica scultorea le preziose finiture artigianali: Adone sorprende per l'audace abbinamento tra la naturalezza del top in legno e la preziosità della base in vetro curvato bocciardato e retroargentato, nelle colorazioni bronzo o nero.

Every room shines of extraordinary beauty with Adone. This table combines the sculptural aesthetics of the natural wooden with precious handcrafted finishes of the base which is made of bush-hammered and back-silvered curved glass, bronze or black finish.

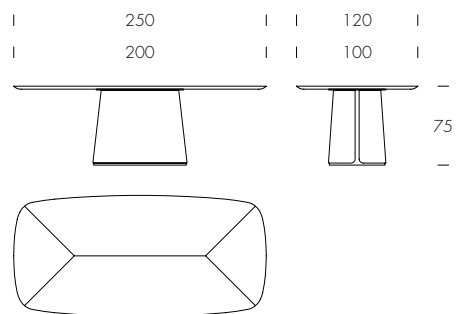

Adone
base vetro bocciardato bronzo /
bush-hammered bronze glass (V83M);
top noce Canaletto /
Canaletto walnut top (14).



adone plissé

L. Roccadadria | E. Barbieri | 2023

Adone Plissé sorprende per l'audace abbinamento tra la naturalezza del top in legno e la preziosità della base in vetro retroargentato, nella versione con pattern plissettato.

Adone Plissé table combines the sculptural aesthetics of the natural wooden with precious handcrafted finishes of the base which is made of bush-hammered and back-silvered curved glass, now in a new plissé version.

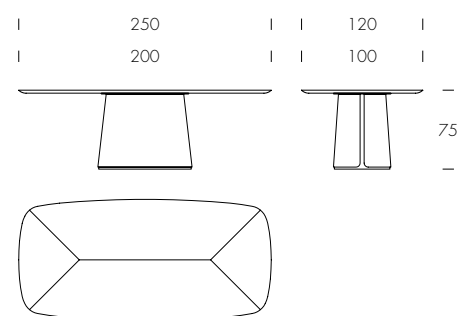

Adone Plissé
base vetro plissetato argento / *pleated silver glass* (VPL45);
top frassino nero / *black ash top* (25).



arco

Angelo Tomaiuolo | 2023

Delicate gambe in legno curvato sostengono Arco, tavolo con top in gres porcellanato nella nuova finitura Tundra. Un elemento di design di grande equilibrio e armonia, per valorizzare con pregio ogni ambiente. Top disponibile nelle varie finiture: Artistic glass, gres porcellanato, legno e marmo.

Delicate curved wooden legs support Arco, a table with a porcelain stoneware top in the new Tundra finish. A design element of great balance and harmony, to enhance any environment with elegance. Top available in different finishing: Artistic glass, porcelain stoneware, wood and marble.

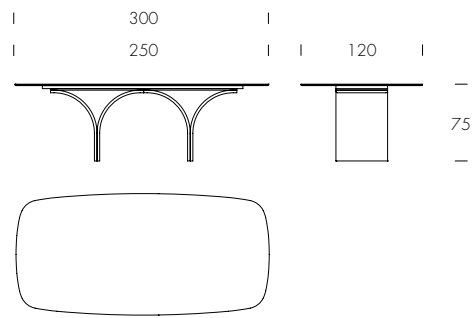

Arco
base noce Canaletto / Canaletto walnut base (14);
top gres Tundra / Tundra porcelain top (V19P).



blade plus

Pierluigi Stella | E. Barbieri | 2023

Tavolo con un'unica base centrale in metallo verniciato, che si apre verso il piano d'appoggio, con leggerezza ed eleganza, rendendo questo elemento d'arredo protagonista della scena. Nella versione Plus il top in porcellana è preziosamente incastonato a filo all'interno di una cornice di legno laccato nero.

Blade Plus has a central painted metal base opening towards the table top with lightness and elegance. In this version, the porcelain top is precisely set flush within a black lacquered wooden frame.

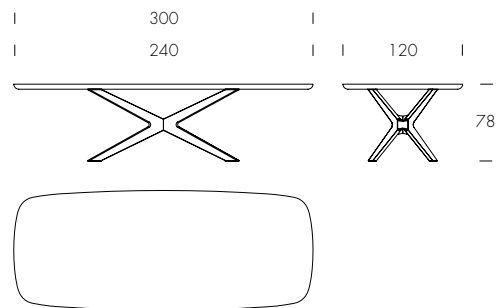



Blade Plus
base grigio carbone / carbon grey base (10);
bordo top laccato nero opaco / matt black ring top;
top gres Macchiavvecchia lucido / glossy Macchiavvecchia porcelain (V87P).

branch

Angelo Tomaiuolo | 2023

Il fascino elegante di Branch nasce dalla combinazione preziosa dei materiali pregiati che lo compongono: la struttura in legno termocurvato incontra il top in porcellana, impreziosito da una sinuosa cornice in legno massello.

Branch table combines precious materials in a unique and refined structure. The base made of heat-bent wood embraces the porcelain top in a sinuous solid wood frame.

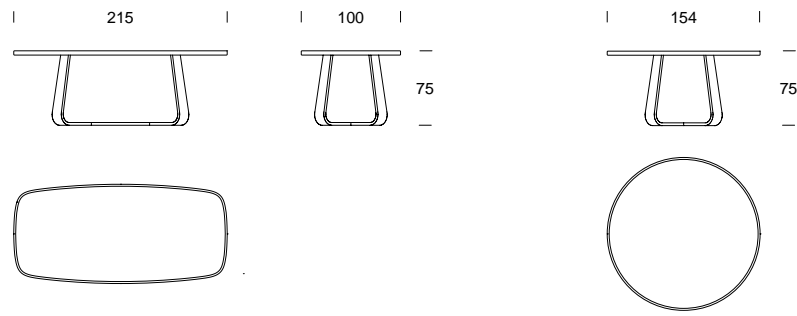



Branch
base noce Canaletto / *Canaletto walnut base* (14);
bordo top noce Canaletto / *Canaletto walnut ring top* (14);
top gres Portoro lucido / *glossy Portoro porcelain* (V85P).



Branch
base frassino nero / black ash base (25);
bordo top frassino nero /
black ash ring top (25);
top gres Macchiavecchia opaco /
matte Macchiavecchia porcelain (V88P).

eliseo brushed

Studio 28 | 2023

Nuova finitura brushed per l'iconico tavolo Eliseo, che valorizza l'intreccio della base grazie alla ricercata finitura spazzolata in versione titanio e bronzo.

A new brushed finish for the iconic Eliseo table, which enhances the weave of the base thanks to the refined brushed titanium and bronze finish.

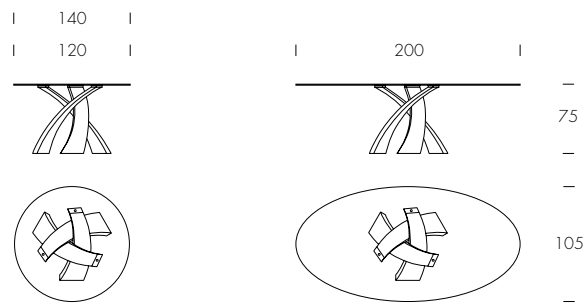



Eliseo Brushed
base brushed titanio /
brushed titanium base (SP34);
top vetro extrachiario trasparente /
extra clear transparent top (V100).

Eliseo Brushed
base brushed bronzo / brushed bronze base (SP83);
top vetro extrachiaro trasparente / extra clear transparent top (V100).



italo

Tonin Casa Creatives | 2023

Tavolo dalla forma senza tempo, con top in legno smussato a botte, reso ancor più raffinato dalle geometrie a spina di pesce che lo compongono, nelle essenze noce canaletto e rovere scuro fiammato.

Il connubio tra la leggerezza della sua linea e l'effetto solido dei ricercati materiali, crea un tavolo perfettamente adattabile ad ogni spazio living, donando un tocco inconfondibile dell'artigianalità Made in Italy.

Table with a timeless shape, a barrel-bevelled wooden top, made even more refined by its herringbone geometries in Canaletto walnut and flamed dark oak. The combination of the lightness of its line and the solid effect of the refined materials creates a table that is perfectly adaptable to any living space, giving it the unmistakable touch of Made in Italy craftsmanship.

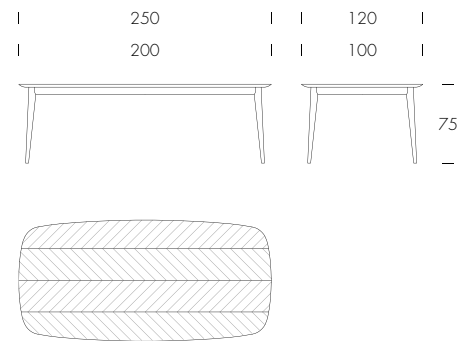



Italo
struttura noce Canaletto /
Canaletto walnut structure (14).

panta rei

Luca Roccadadria | 2023

Il tavolo Panta Rei trae ispirazione dalla natura e dal flusso del divenire. Il vetro stampato decorato con serigrafia esplora il potenziale espressivo dei materiali: 12 mm di spessore interpretano in modo inedito le venature del marmo, creando l'effetto organico di un flusso dove tutto scorre, in un tavolo sorprendente che valorizza l'identità di ogni tipo d'interni.

The Panta Rei table draws inspiration from nature and the flow of becoming. The screen-printed glass explores the expressive potential of materials. 12 mm thick glass showing the veining of marble in a new way and creating the organic effect of a flow in a striking table that enhances the identity of any room.

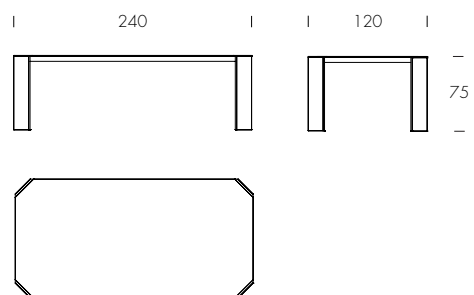



Panta Rei
struttura artistic glass Galaxy black and white /
artistic glass Galaxy black and white structure (STO1).

pois élite

Angelo Tomaiuolo | E. Barbieri | 2023

Il tavolo Pois Élite sorprende per l'audace abbinamento tra la naturalezza del top in legno nella finitura noce canaletto o frassino nero e l'eccentrica base in metallo verniciato, formata dall'accostamento dell'elemento decorativo dei pois. Per un effetto di grande presenza scenica in ogni tipo di spazio living.

Pois Élite table surprises with its bold combination mixing the simplicity of the naturalness of the wooden top and an eclectic painted metal base made of decorative pois. A great scenic presence in any living space.

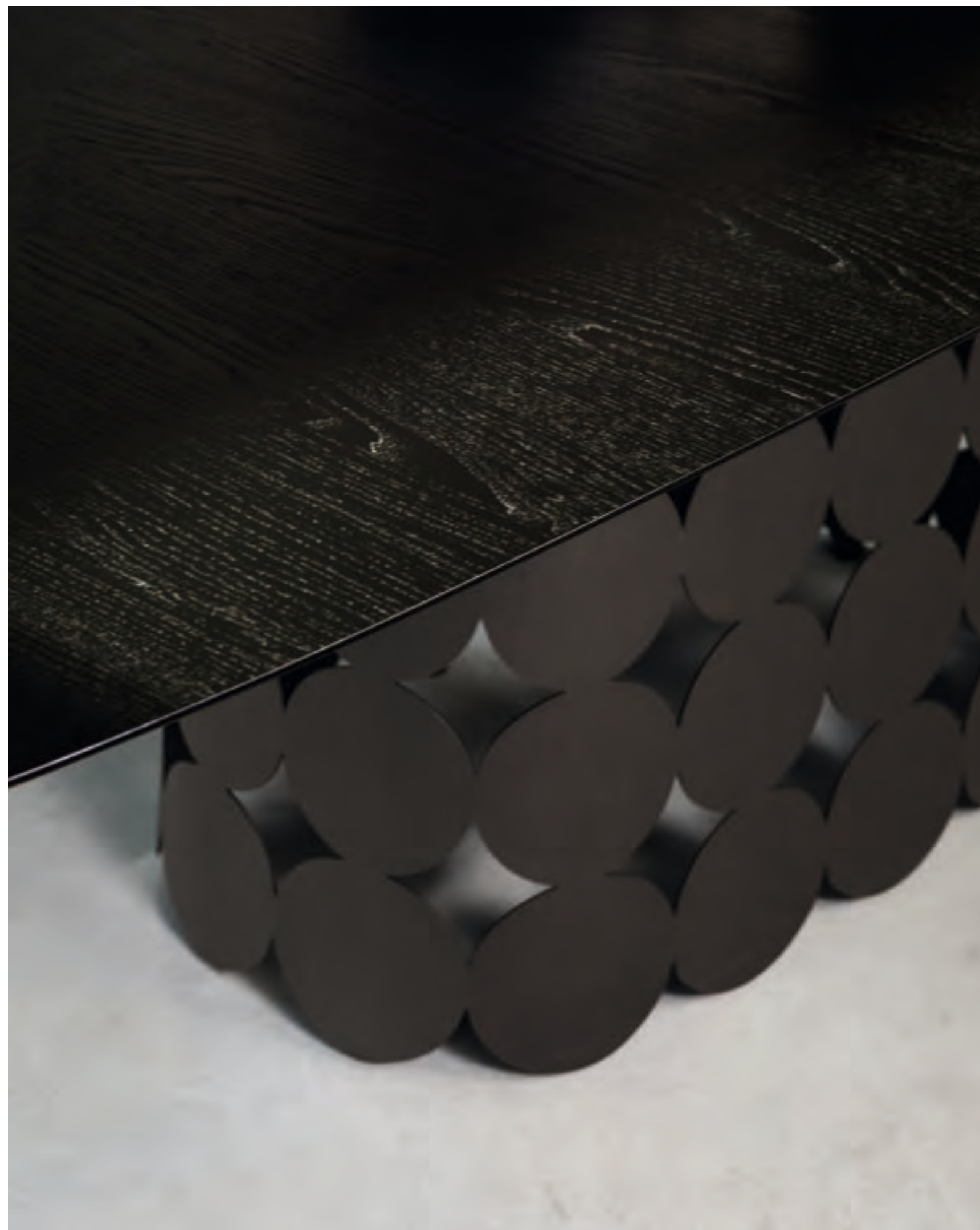
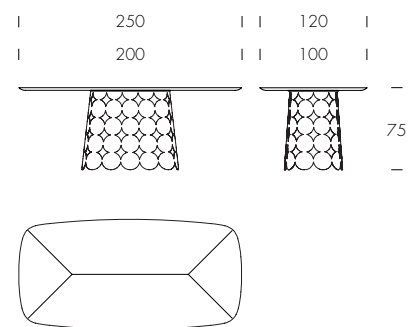



Pois Élite
base grigio carbone / carbon grey base (10);
top frassino nero / black ash top (25).

reverse artistic glass

E. Barbieri | M. Mottin | 2023

Il tavolo Reverse viene impreziosito dalla nuova finitura artistic glass nelle due varianti Crystal Calacatta e Galaxy black & white con bisello da 25 mm.

The Reverse table is embellished with the new artistic glass finish in two variants: Crystal Calacatta and Galaxy black & white with a 25 mm bevel.

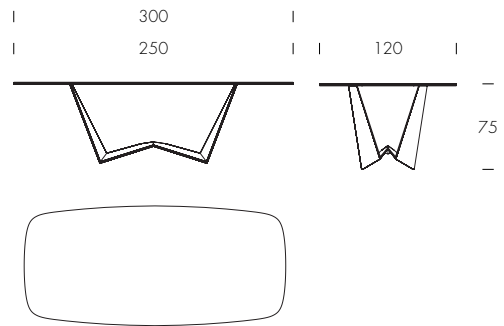

Reverse artistic glass
base bronzo pietra / stone bronze base (83);
top artistic glass Crystal Calacatta /
artistic glass Crystal Calacatta top (ST02).



reverse mini

E. Barbieri | M. Mottin | 2023

L'iconico tavolo Reverse è caratterizzato dalla base reversibile, che lo rende versatile e originale. La struttura in acciaio verniciato dal design grafico e definito esalta la leggerezza dei ripiani nelle varie finiture come vetro, ceramica e porcellana, arricchendosi ora con la versione Mini Reverse, con top disponibile in varie misure: 160, 180 e 200 cm. Una soluzione perfetta per spazi ridotti, senza rinunciare alla bellezza del design dall'eleganza distintiva.

The iconic Reverse table is characterized by the reversible base, which makes it versatile and original. The painted steel structure with a graphic and defined design enhances the lightness of the shelves in the various finishes such as glass, ceramic and porcelain, now enriched with the Mini Reverse version, with top available in various sizes: 160, 180 and 200 cm. A perfect solution for small spaces, without sacrificing the beauty of the distinctively elegant design.

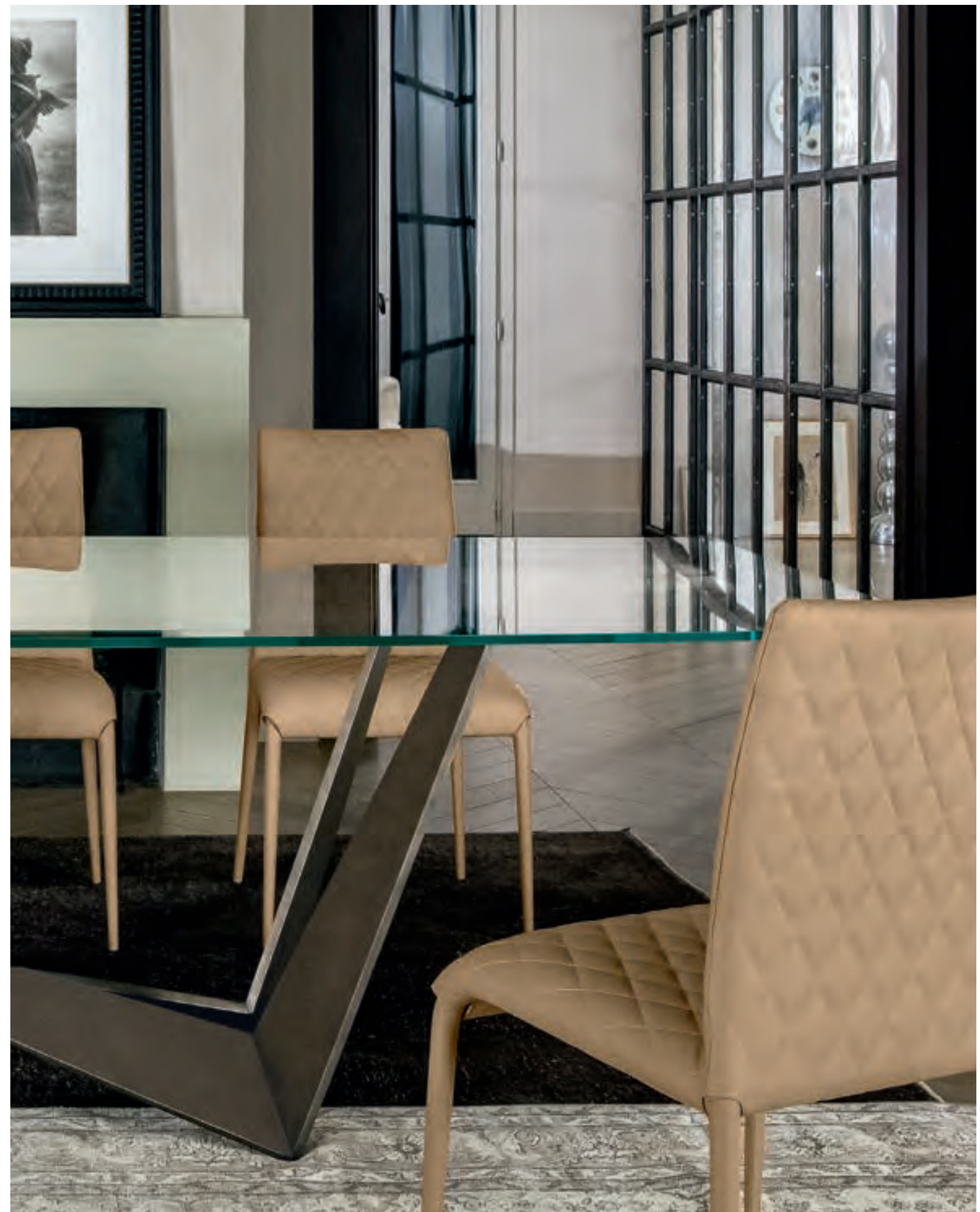
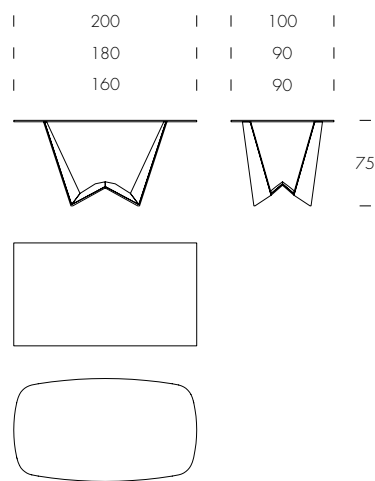

tenso orione couture

Angelo Tomaiuolo | E. Barbieri | 2023

leggero, prezioso, elegante: è Tenso, tavolo dal design iconico, che sembra scolpito con la luce e la materia. La struttura è caratterizzata da un raffinato intreccio di tubi in metallo verniciato che si intersecano e creano un design deciso, incontrando ora anche il nuovo top nella finitura in resina Orione Couture, che rende ogni pezzo un elemento di design unico.

Light, precious, elegant: it's Tenso, a table with an iconic design that seems sculpted with light and matter. The structure is characterized by a refined interweaving of painted metal tubes that intersect and create a decisive design, now also meeting the new top in the Orione Couture resin finish, which makes each piece a unique design element.

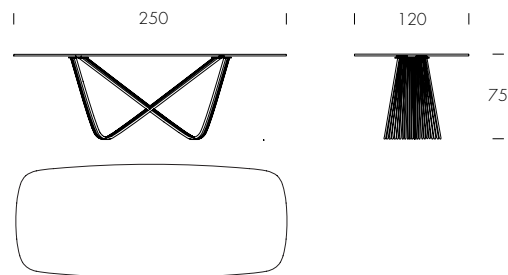



Tenso Orione Couture
base oro opaco / matt gold base (85);
top resina Orione Couture /
Orione Couture resin top.

thunder

Maurizio Varsi | 2023

Thunder trasmette un'estetica forte e decisa, data dall'elegante eccentricità della sua base in acciaio verniciato composta da incroci angolari sapientemente lavorati. Il piano in cristallo 12 mm extrachiaro bisellato è impreziosito da decorazioni artistiche che evocano le venature del marmo e si ispirano agli elementi naturali, creando un elemento d'arredo di pura bellezza.

Thunder conveys a strong and decisive aesthetic, given by the elegant eccentricity of its painted steel base, composed of expertly crafted angular crosses. The 12 mm extra-clear beveled glass top is embellished with artistic decorations that evoke marble veins and are inspired by natural elements, creating a piece of furniture of pure beauty.

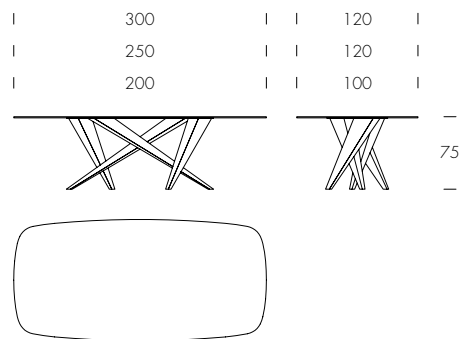

Thunder
base bronzo pietra / stone bronze base (83);
top artistic glass Crystal Calacatta /
artistic glass Crystal Calacatta top (ST02).

zeno

Tonin Casa Creatives | 2023

Zeno è il nuovo tavolo allungabile, realizzato completamente in legno, dalle linee morbide e ben definite. Un pezzo d'arredo elegante e versatile, grazie alle allunghe in alluminio; è disponibile nelle varianti frassino nero e noce canaletto.

Zeno is the new extendable table, entirely made of solid wood, with soft and well-defined lines. An elegant and versatile piece of furniture, thanks to the aluminum extensions; available in black ash and canaletto walnut color variants.

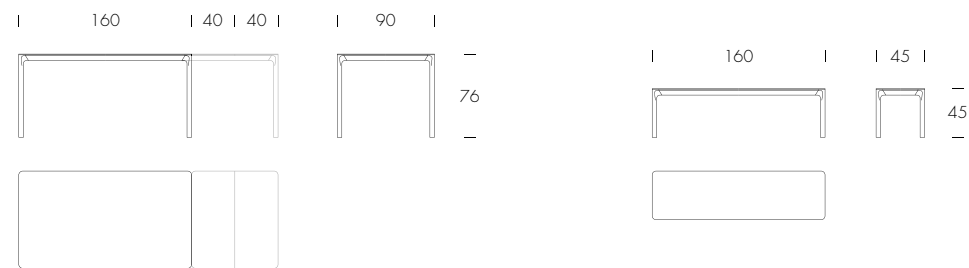



bea

Angelo Tomaiuolo | 2023

La seduta Bea valorizza ogni spazio con un tocco glamour: il suo rivestimento sartoriale in pelle o tessuto è esaltato dall'elegante e morbida struttura. Bea è disponibile nelle varie finiture con gambe in noce canaletto o frassino nero.

The Bea chair enhances any space with a touch of glamour with its tailored leather and its fabric upholstery. Bea has a wooden structure in canaletto walnut or black ash.

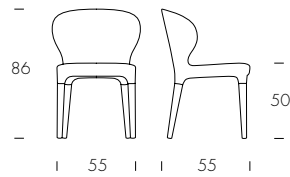

Bea
base frassino nero / black ash base (25);
rivestimento pelle panna / cream leather covering (P5).



bea plus

Angelo Tomaiuolo | 2023

Bea Plus è la versione completamente rivestita con le preziose combinazioni di velluto, pelle o tessuto.

Bea Plus version is fully upholstered in the precious combinations of velvet, leather or fabric.

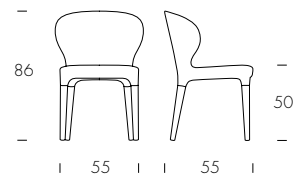

Bea Plus
rivestimento pelle panna / cream leather covering (P5).

cleo

Tonin Casa Creatives | 2023

La poltroncina Cleo è espressione di glamour senza tempo. Confortevole e solida, Cleo esalta ogni spazio living con la sua identità di grande impatto. Disponibile anche nella versione Élite, con elegante trapuntatura a rombi sullo schienale.

The Cleo armchair is an expression of timeless glamour. Comfortable and solid, Cleo enhances any living space with its high-impact identity. Also available in the Élite version, with elegant diamond quilting on the backrest.

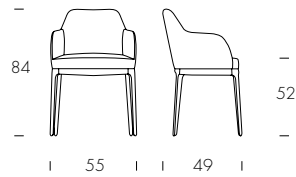

dafne

E. Barbieri | M. Mottin | 2023

Perfetta sintesi di comfort e design, Dafne accoglie la seduta con la sua linea morbida, impreziosita dal tocco sartoriale che si rileva nei dettagli delle lievi arricciature sulla parte interna dello schienale. La seduta, esaltata dalle slanciate gambe in legno massello, è disponibile in vari rivestimenti, come pelle, tessuto o velluto.

The perfect synthesis of comfort and design. Dafne shows a tailored touch that can be seen in the details of the slight curls on inner part of the backrest. The seat with solid wood legs is available in leather, fabric or velvet.

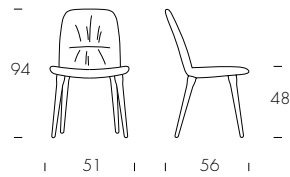

Dafne
base noce Canaletto /
Canaletto walnut base (14);
rivestimento pelle terra di Siena /
terra di Siena leather covering (P37).



dafne swivel

E. Barbieri | M. Mottin | 2023

Perfetta sintesi di comfort e design, Dafne Swivel, con base in metallo, accoglie la seduta grazie alla sua linea morbida, impreziosita dal tocco sartoriale che si rileva nei dettagli delle lievi arricciature sulla parte interna dello schienale.

Perfect synthesis of comfort and design, Dafne Swivel is composed by a metal base and a seat with a tailored touch that can be seen in the details of the slight curls on the inner part of the backrest.

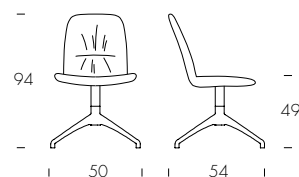

Dafne Swivel
rivestimento pelle terra di Siena /
terra di Siena leather covering (P37).

dauphine

L. Roccadadria | E. Barbieri | 2023

Eleganza e leggerezza formale: Dauphine è una sedia monoscocca dalla particolare struttura che ricorda la coda di un delfino, con base in legno massello nelle finiture noce canaletto, frassino nero o rovere scuro e rivestimento disponibile in cuoio, pelle, tessuto o nelle combinazioni pelle e tessuto. Dauphine naked è disponibile nella versione in tessuto o pelle con il retro schienale in essenza.

Elegance and lightness: Dauphine is a one-piece chair with a distinctive structure reminiscent of a dolphin's tail. The structure is made of solid wood in different finishes and upholstery is available in leather, fabric or leather and fabric combinations. Dauphine naked is available in fabric or leather with a backrest in wood.

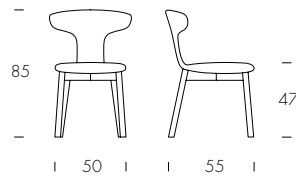

Dauphine
base frassino nero / black ash base (25);
rivestimento cuoio naturale /
natural thick leather covering (K32).



elmo

Tonin Casa Creatives | 2023

Il tratto distintivo della sedia Elmo è la particolare struttura dello schienale che evoca nella parte inferiore un guscio in pelle o tessuto, donando un'esperienza di seduta particolarmente confortevole. Il ricercato accostamento tra le sottili gambe in metallo nelle diverse finiture e la linea decisa della seduta dà vita a un'originale combinazione stilistica dalla forte personalità.

The distinguishing feature of the Elmo chair is the structure of the backrest that evokes a leather or fabric shell, giving a particularly comfortable seating experience. The refined combination of slender metal legs in different finishes and the line of the seat creates an original stylistic combination with a strong personality.

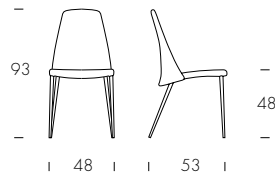

Elmo
base oro opaco / matt gold base (85);
rivestimento ecopelle nubuck nocciola /
hazel nubuck eco-leather covering (SN01).

lisa

Tonin Casa Creatives | 2023

L'eleganza contemporanea della sedia Lisa spicca con la sua linea raffinata e ben definita, inserendosi perfettamente in ogni spazio living. Lisa è composta da struttura in schiumato, resa ancor più confortevole grazie al doppio rivestimento disponibile nelle varie finiture di pelle e tessuto.

The contemporary elegance of the Lisa chair stands out with its refined and strong line, fitting perfectly into any living space. Lisa is composed of a foam structure, made even more comfortable thanks to the double upholstery available in leather or fabric.

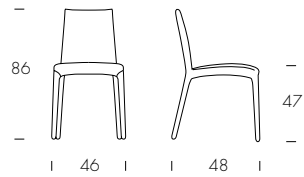

Lisa
rivestimento velluto Vega crema /
cream Vega velvet covering (T21V).



lisa cuoio

Tonin Casa Creatives | 2023

L'eleganza contemporanea della sedia Lisa spicca con la sua linea raffinata e ben definita, inserendosi perfettamente in ogni spazio living. Lisa Cuoio è composta da struttura in schiumato, resa ancor più confortevole grazie al rivestimento completamente in cuoio.

The contemporary elegance of the Lisa chair stands out with its refined and strong line, fitting perfectly into any living space. Lisa Cuoio is composed of a foam structure, made even more comfortable thanks to the completely upholstery in thick leather.

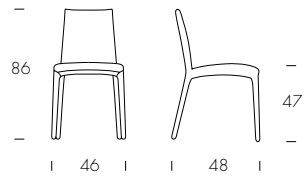

Lisa cuoio
rivestimento cuoio naturale /
natural thick leather covering (K32).



mademoiselle

E. Barbieri | 2023

La sedia Mademoiselle è espressione di un design confortevole ed elegante. La sua linea delicata poggia su gambe in legno tinto noce, rovere scuro o frassino nero. La seduta è rivestita in tessuto, ecopelle, pelle o velluto. La sedia Mademoiselle è impreziosita nella versione Élite dallo schienale realizzato con delicate cuciture con lavorazione a rombi.

The Mademoiselle chair is an expression of comfortable and elegant design. Its delicate line rests on legs in walnut-stained wood, dark oak or black ash. The seat is upholstered in fabric, eco-leather, leather or velvet. The Mademoiselle chair is embellished in the Élite version with a backrest made with delicate diamond-stitching.

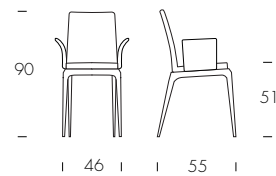
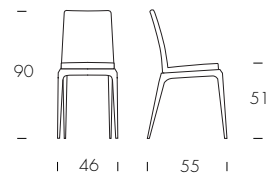

Mademoiselle
base noce Canaletto / Canaletto walnut base (14);
rivestimento pelle panna / cream leather covering (P5).



Mademoiselle
base frassino nero / black ash base (25);
rivestimento pelle beige / beige leather covering (P36).



olympia

E. Barbieri | 2023

Olympia è la nuova ampia seduta dal massimo comfort, dato dalla sua struttura avvolgente con imbottitura memory foam e comodi braccioli. Il ricercato accostamento tra le sottili gambe in metallo o legno nelle varie finiture e la linea morbida e sinuosa della seduta dà vita a una combinazione stilistica unica. La sua linea elegante è disponibile sia nella versione poltroncina sia sedia.

Olympia is the new wide seat characterised by the maximum comfort, given by its structure with memory foam padding and comfortable armrests. The sophisticated combination of slender metal or wooden legs in various finishes and the soft, sinuous line of the seat creates a unique combination. Its elegant line is available in both armchair and chair versions.

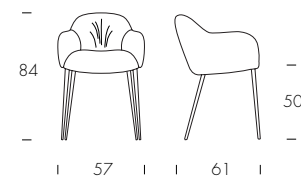
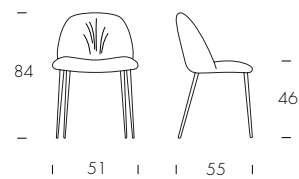



Olympia
base grigio carbone / carbon grey base (10);
rivestimento pelle bianco / white leather covering (P1).



spillo

Tonin Casa Creatives | 2023

Le caratteristiche principali della seduta Spillo sono l'esile eleganza della struttura e la confortevole linearità della seduta. Disponibile in varie ed esclusive finiture, Spillo si adatta a molteplici ambienti e contesti.

The main features of the Spillo seat are the slender elegance of the structure and the comfortable linearity of the seat. Available in various exclusive finishes, Spillo adapts to multiple environments and contexts.

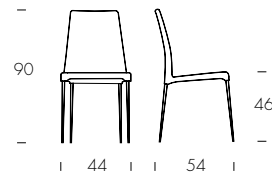

Spillo
base grigio carbone / carbon grey base (10);
rivestimento tessuto Shade grigio chiaro /
light grey Shade fabric covering (SH43).

tender

Studio Archirivolto | 2023

Morbida e accogliente, la sedia Tender garantisce un comfort ottimale che si coniuga al design contemporaneo e deciso della sua linea. La base in legno massello sapientemente lavorata dona un'estetica unica a questa sedia ricca di personalità. Tender è disponibile nelle varie finiture in pelle, tessuto o velluto.

Soft and cosy, the Tender chair guarantees optimal comfort combined with a contemporary design. The skilfully crafted solid wood base lends a unique aesthetic and a strong personality. Tender is available in leather, fabric or velvet.

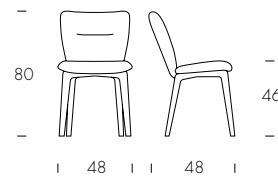

Tender
base frassino nero / black ash base (25);
rivestimento tessuto Bouclé bianco avana /
havana white Bouclé fabric covering (TB908).

ZOE

E. Barbieri | 2023

Seduta dall'estetica accogliente e dall'innata eleganza, Zoe si adatta ad ogni stile di interni con la sua linea sinuosa, caratterizzata dalla struttura in legno massello. Zoe è disponibile in varie finiture e texture, come pelle, velluto e tessuto, per dar vita ad ambienti dallo stile unico.

Thanks its welcoming and elegant aesthetic Zoe adapts to any interior style with its sinuous line, characterised by its solid wood frame. Zoe is available in various finishes and textures, such as leather, velvet and fabric.

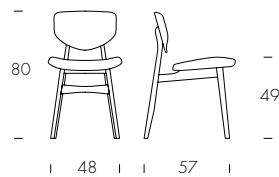

Zoe
base frassino nero / black ash base (25);
rivestimento pelle panna / cream leather covering (P5).



Zoe
base frassino nero / black ash base (25);
rivestimento combinazione Grigio d'inverno: tessuto Flora grigio chiaro - beige e pelle grigio gabbiano /
Grigio d'inverno combination covering: light grey - beige Flora fabric and gull grey leather (04).

cleo

Tonin Casa Creatives | 2023

La Collezione Cleo, espressione di glamour senza tempo, si completa con il confortevole e solido sgabello, per esaltare ogni ambiente grazie alla sua identità di grande impatto.

The Cleo Collection, an expression of timeless glamour, is completed with the comfortable and solid stool, to enhance any environment thanks to its impactful identity.

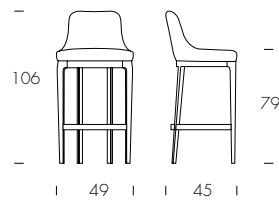

Cleo
base noce Canaletto / *Canaletto walnut* base (14);
rivestimento tessuto Flora grigio scuro - bianco /
dark grey - white Flora fabric covering (TF03);
base frassino nero / *black ash* base (25);
rivestimento tessuto Flora marrone - grigio scuro /
brown - dark grey Flora fabric covering (TF02).



olympia

E. Barbieri | 2023

La linea morbida e sinuosa della sedia e della poltroncina Olympia, si arricchisce anche della variante sgabello, finemente progettata per accogliere con il massimo comfort, grazie all'ampia seduta e all'avvolgente struttura con imbottitura memory foam.

Soft and sinuouse shapes of the Olympia chair and armchair is completed with the stool, designed to accomodate with high comfort, thanks to the large seat and enveloping structure with padding memory foam.



Olympia
rivestimento pelle bianco / white leather covering (P1).

cleto

Tonin Casa Creatives | 2023

Un divano componibile dalle forme nitide e sinuose: Cleto è una sintesi perfetta di linee morbide ed essenziali. Le ampie sedute donano una sensazione di accoglienza e comfort, resa ancor più invitante dalla forma delicatamente curva del suo design. La sapiente componibilità di Cleto consente infinite combinazioni, permettendo di adattare la forma del divano all'ambiente, per poter esprimere al meglio il proprio ideale di raffinata comodità.

A modular sofa with sharp, sinuous shapes. Cleto is the perfect synthesis of soft, essential lines. The wide seats give a feeling of cosiness and comfort, made even more inviting by the gently curved shape of its design. Its modularity allows for infinite combinations to be adapted to the environment and best express one's ideal of refined comfort.

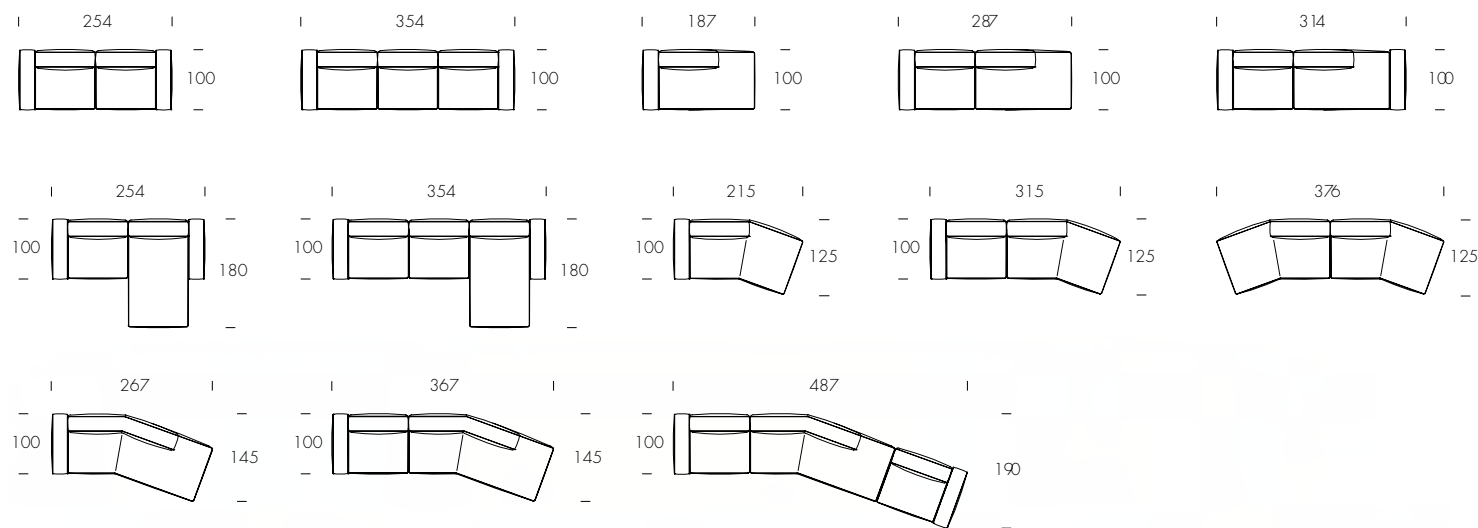



Cleto
rivestimento tessuto Bouclé blu /
blue Bouclé fabric covering (TB604).

london

Tonin Casa Creatives | 2023

Divano componibile impreziosito da inserti in legno, ideali per contenere libri, oggetti e riviste. London è disponibile nelle varianti tessuto, pelle, velluto e nella nuova finitura Bouclé.
L'effetto solido del suo design unisce alla perfezione estetica contemporanea, funzionalità e massimo comfort.

Modular sofa embellished with wooden inserts ideal for storing books, objects and magazines. London is available in fabric, leather, velvet and the new Bouclé finish. The solid effect of its design combines contemporary aesthetics, functionality and maximum comfort to perfection.

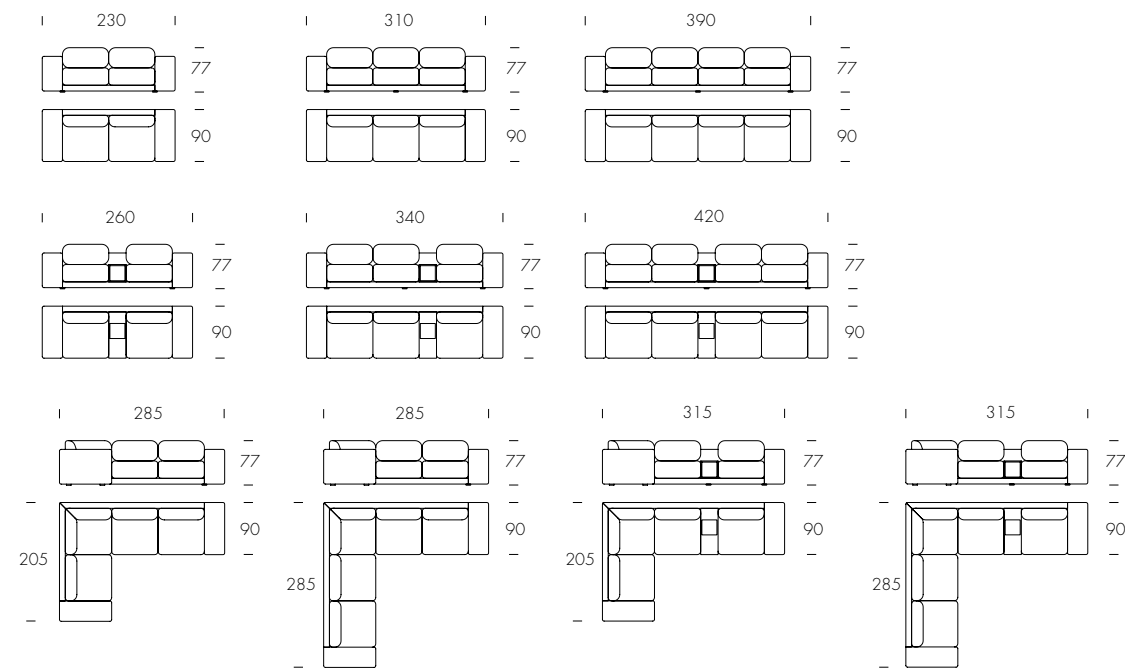



London
rivestimento tessuto Bouclé beige /
beige Bouclé fabric covering (TB907).

capriccio

Tonin Casa Creatives | 2023

Un'esplosione del più autentico gusto Made in Italy, unita alla sintesi di comfort e morbidezza che la sua estetica comunica: è Capriccio, la poltrona dalle forme sinuose, un esempio di squisita artigianalità che evoca le lavorazioni sartoriali grazie alla sua impeccabile manifattura eseguita interamente a mano. I tratti distintivi di Capriccio sono la sua comoda seduta compatta e accogliente e la ricca lavorazione a capitonné, perfetta espressione della più alta maestria artigianale.

An explosion of the most authentic Made in Italy taste combined with the synthesis of comfort and softness. Capriccio, with its sinuous shapes, represents an example of exquisite craftsmanship that evokes a sartorial taste. The distinctive features of Capriccio are its comfortable, compact and cosy seat combined with the rich capitonné workmanship.

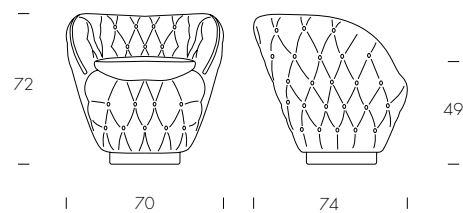

Capriccio
rivestimento pelle giallo / yellow leather covering (P4).

milo

Tonin Casa Creatives | 2023

Morbide geometrie e comfort avvolgente si incontrano nel divano e nella poltrona della collezione Milo, che si distingue per la sua estetica raffinata, sintesi di tradizione e design, adattandosi ad ogni stile di interni. Milo è disponibile in varie finiture, dalla morbidezza del velluto alle lavorazioni sartoriali in pelle ed esclusivi tessuti.

Soft geometries and comfort meet in the sofas and armchairs of the Milo collection. This line stands out for its refined aesthetics, a synthesis of tradition and design, adapting to any interior style. Milo is available in various finishes, from the softness of velvet to tailored leather and exclusive fabrics.

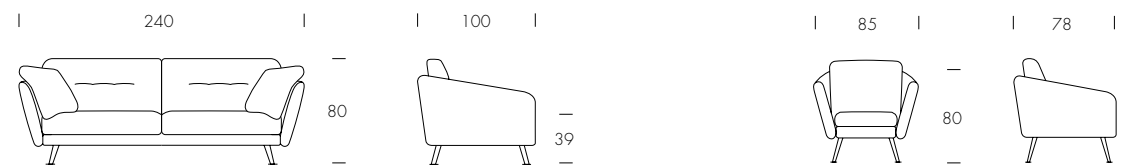



Milo
rivestimento tessuto Shade deserto /
desert Shade fabric covering (SH63).

tender lounge

Studio Archirivolto | 2023

Avvolgente come un abbraccio delicato, la poltrona Tender Lounge garantisce un comfort ottimale dove godersi in pieno relax il tempo per sé. Il suo design contemporaneo e deciso combina la struttura in legno curvato con base in metallo ai rivestimenti disponibili nelle varie finiture in pelle, tessuto o velluto.

Soft and cosy, the Tender Lounge armchair guarantees optimal comfort combined with a contemporary design. The skilfully crafted solid wood base lends a unique aesthetic and a strong personality. Tender is available in leather, fabric or velvet.

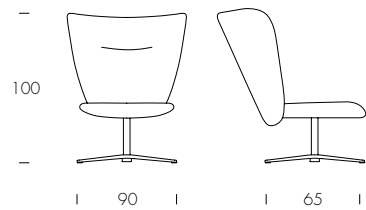

Tender Lounge
rivestimento pelle grigio / grey leather covering (P73).

aira wood

Cristian Dal Bianco | 2023

La madia Aira si arricchisce nella nuova versione Wood, con inserti a lavorazione a spina di pesce che esaltano la materica naturalezza del legno. Dotata di led interno e di aperture laterali delle due vetrine, conferisce un'identità esclusiva ad ogni spazio abitativo.

The Aira sideboard is enriched in the new Wood version, with herringbone geometries inserts that enhances the natural texture of the wood. Equipped with internal LEDs and with side openings on the two glass doors, it gives an exclusive identity to any living space.

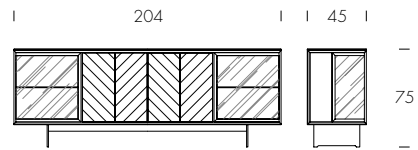



Aira Wood
ante vetro fumè trasparente /
transparent fumè glass doors (V85);
struttura noce Canaletto /
Canaletto walnut structure (T4).

all star

Angelo Tomaiuolo | 2023

La madia All Star fonde la sua linea essenziale alla preziosa costellazione di petali in legno, applicati a mano, che ricoprono le ante dalle basi specchiate, per un elemento unico di design e alta artigianalità.

The All Star sideboard combines its essential line with the precious constellation of solid wood petals, hand-applied, that cover the doors with mirrored bases, for a unique design element of high craftsmanship.

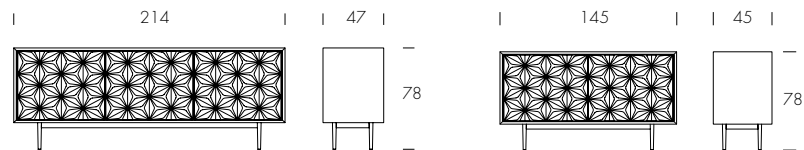

All Star
ante specchio fumè / fumè mirror doors (VS87);
struttura frassino nero / black ash structure (25).





All Star
ante specchio bronzo / bronze mirror doors (V184);
struttura noce Canaletto / Canaletto walnut structure (14).



anemos

Giuseppe Maurizio Scutellà | 2023

La lieve brezza dell'eleganza può soffiare in qualunque stanza con la madia Anemos, il cui nome allude al vento che sembra muovere l'elemento specchiante. Un pezzo dal design intriso di fascino, che testimonia la continua ricerca di tecniche di lavorazione uniche e preziose.

The gentle breeze of elegance can blow in any room with the Anemos sideboard, whose name alludes to the wind that seems to move the reflecting element. A piece of design imbued with charm, which testifies to the continuous search for unique and precious processing techniques.

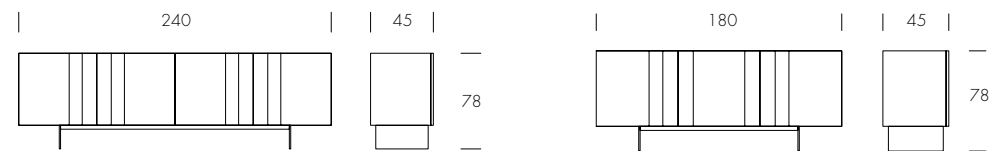



Anemos
ante specchio argentato / silver mirror doors (V45).



Anemos
ante specchio bronzo /
bronze mirror doors (V184).

beyond

M. Mottin | E. Barbieri | 2023

Beyond, una madia esclusiva, creata dal connubio perfetto tra Natura e Design: la perfezione degli elementi naturali si fa scultura, in questo arredo d'Arte, prezioso equilibrio tra la levigatezza setosa del marmo e la sua matericità, per andare oltre lo strato visibile, cercando nella sua essenza le venature naturali che lo rendono vivo, creando un movimento che la luce accende di mille riflessi brillanti.

Beyond, an exclusive sideboard, created from the perfect combination of Nature and Design: the perfection of natural elements becomes sculpture, in this piece of art furniture, a precious balance between the silky smoothness of marble and its materiality, to go beyond the visible layer, seeking in its essence the natural veins that make it alive, creating a movement that the light ignites with a thousand brilliant reflections.

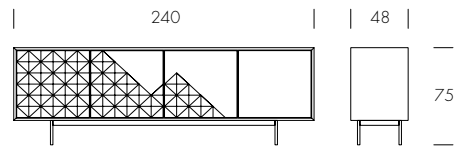



Beyond
ante marmo ombra di Caravaggio / *ombra di Caravaggio marble doors*
struttura frassino nero / *black ash structure* (25).

bombè

Luca Roccadadria | 2023

Madia contenitore in legno laccato nero, a tre o quattro ante laccato nero lucido, con piedini in metallo verniciato.
Le bombature che la caratterizzano creano un gioco di luci e ombre, in un equilibrio estetico perfetto di volumi che la rendono protagonista della scena.

A black lacquered wooden sideboard with three or four black glossy lacquered doors, with painted metal feet. The curves that characterize it create a play of light and shadow, in a perfect aesthetic balance of volumes that make it the protagonist of the scene.

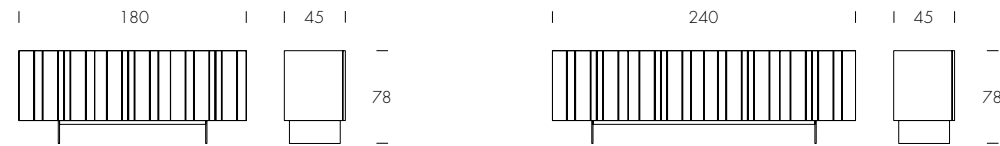



Bombè
ante laccato nero lucido / glossy black laquered doors.

coated

Tonin Casa Creatives | 2023

Una credenza con lavorazione spazzolata disponibile nella versione bronzata, rame o titanio. Una texture semplice ma di effetto per abbinare le madie alle basi dei nostri tavoli.

A sideboard with a brushed finish available in bronze, copper, or titanium. A simple but effective texture to match the sideboards with the bases of our tables.

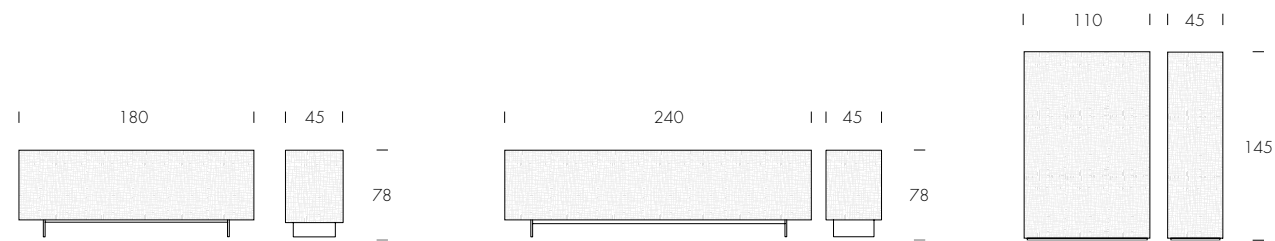



Coated
struttura brushed titanio / brushed titanium structure (SP34).



kintsugi

M. Mottin | E. Barbieri | 2023

Madia contenitore a quattro ante rivestite con lastre ceramiche che riproducono l'effetto dell'antica arte giapponese del Kintsugi, con la quale ogni oggetto diventa ancor più pregiato nella sua unicità. La delicatezza simbolica della madia, unita al suo design contemporaneo ed essenziale, la rende un pezzo dal valore estetico unico, evidenziato dalle preziose venature che la caratterizzano. Questa madia è dotata di funzionali ripiani interni in vetro, struttura in frassino nero e piedini in metallo verniciato.

A four-door storage unit covered with ceramic slabs that reproduce the effect of the ancient Japanese art of Kintsugi, with which every object becomes even more precious in its uniqueness. The symbolic delicacy of the sideboard, combined with its contemporary and essential design, makes it a piece of unique aesthetic value, highlighted by the precious veins that characterize it. This sideboard is equipped with functional internal glass shelves, a glossy black lacquered wooden structure, and painted metal feet.

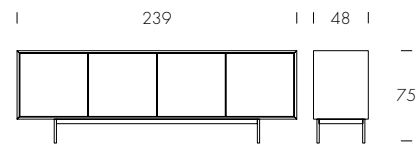
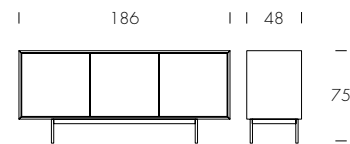



Kintsugi
ante ceramica affetto kintsugi /
ceramic with kintsugi effect doors;
struttura frassino nero / black ash structure (25).

magma

Luca Roccadadria | 2023

Madia contenitore a tre o quattro ante rivestite in pellicola bronzo con tecnologia post-forming e top curvato in monolastra di vetro martellato nero, con piedini in metallo bronzato. Magma evoca l'effetto dato dalla fluida matericità del vetro martellato che, fondendosi con il legno delle ante, dona alla madia un effetto scenico che valorizza ogni ambiente, rendendolo prezioso.

A sideboard with three or four lacquered bronze doors and a curved top made of black hammered monolithic glass, with bronzed metal feet. Magma evokes the effect created by the fluid texture of the hammered glass, which, blending with the wood of the doors, gives the sideboard a dramatic effect that enhances any environment, making it precious.

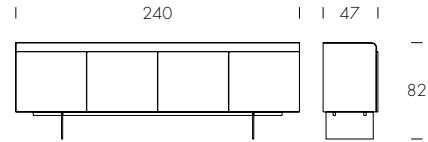
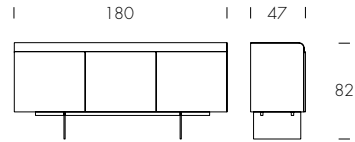

Magma
top vetro nero martellato / *hammered black glass (V02M)*;
ante color bronzo / *bronze colour doors.*



millebolle

Luca Roccadadria | 2023

Madia contenitore a tre o quattro ante in cristallo specchiato bronzo o fumè, con struttura in legno laccato nero lucido e piedini in metallo verniciato.
Il design dall'identità decisa della madia Millebolle è esaltato dal contrasto tra la base matt satinata delle ante e la pioggia di bolle in cristallo lucido che le ricoprono, a creare un gioco di luci e ombre che dona un'identità audace ad ogni ambiente.

Sideboard with 3 or 4 doors made of crystal bronze or fumè finish, wooden lacquered structure polish black and painted metal base.
Millebolle has a strong identity design which is highlighted by the contrast between the matt satin finish of the doors and a shower of shiny crystal bubbles.
This delightful play of light and shadow lends a certain boldness to any room.

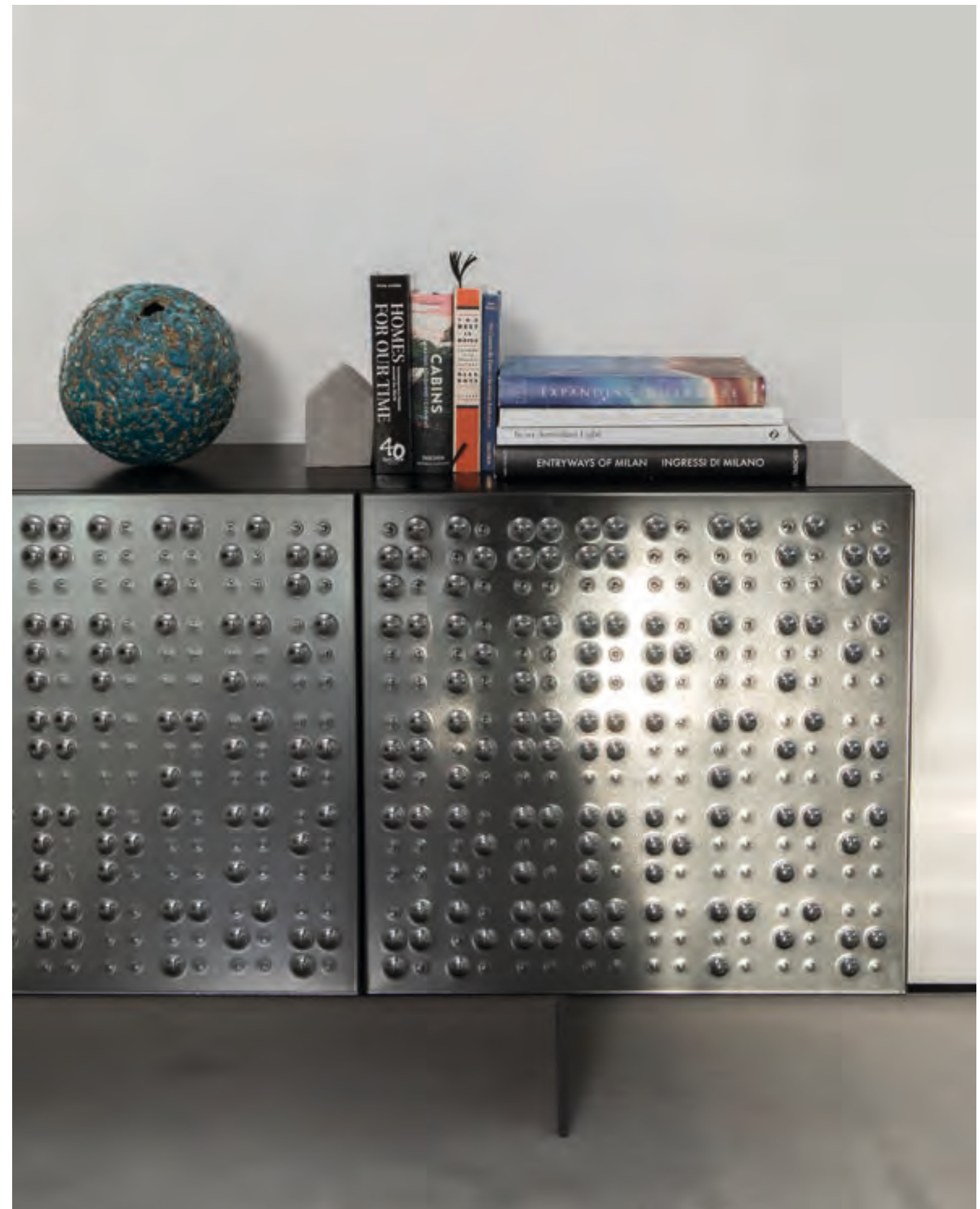
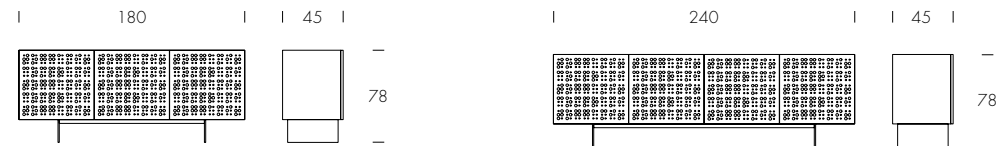



monolite

M. Mottin | E. Barbieri | 2023

Madia contenitore a quattro ante completamente rivestite esternamente con pellicola di riproduzione marmorea applicata con tecnologia post-forming e laccata lucida 100 gloss: Monolite sorprende per la purezza del suo design, con la sua forte linea scultorea che diventa protagonista della scena.

A sideboard with four lacquered doors completely covered externally with marble reproduction film applied with post-forming technology and lacquered with 100 gloss: Monolite surprises with the purity of its design, with its strong sculptural line becoming the protagonist of the scene.

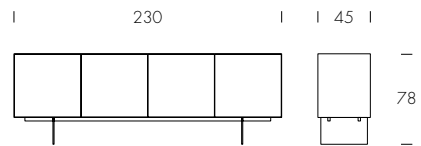

Monolite

struttura laccata extra lucido su riproduzione marmorea /
extra glossy laquered structure with marble effect.



passepourtout

M. Mottin | E. Barbieri | 2023

Madia contenitore a tre o quattro ante rivestite esternamente con pellicola champagne applicata con tecnologia post-forming, con piedini in metallo verniciato.
Il suo design lineare e contemporaneo la rende un passepourtout adatto ad ogni contesto living.

A sideboard with three or four lacquered wood doors, available in champagne tone with painted metal feet. Its linear and contemporary design makes it a passepourtout suitable for any living context.

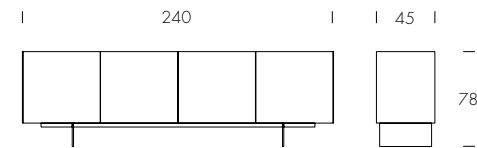
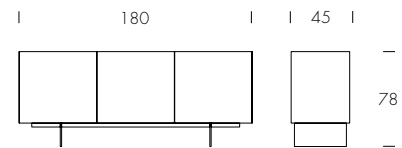

Passepourtout
struttura color champagne / champagne colour structure (60).



pizzo

Luca Roccadadria | 2023

Madia contenitore a tre o quattro ante, caratterizzata da uno strato di spatolato di argilla interamente lavorata a mano con finiture effetto pizzo a rilievo, nella nuance burro, con piedini in metallo verniciato.
Un elemento d'arredo prezioso, la cui lavorazione ricorda un tessuto in pizzo, leggero ed elegante.

A sideboard with three or four doors, characterized by a layer of hand-worked clay spatula with relief lace effect finishes, in butter shade, with painted metal feet.
A precious piece of furniture, whose processing recalls a lace fabric, light and elegant.

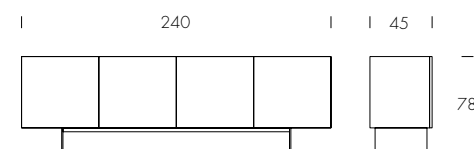
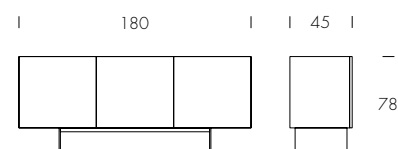



Pizzo
struttura color burro / butter colour structure.



rock

Luca Roccadadria | 2023

Madia contenitore a tre o quattro ante in cristallo specchiato bronzo o fumè, con struttura in legno laccato nero lucido e piedini in metallo verniciato.
Il design dirompente della madia Rock si adatta perfettamente ad ambienti dall'estetica contemporanea, grazie alla particolare lavorazione in monolatra di vetro con nove bolle a rilievo per ciascuna anta.

Sideboard with 3 or 4 doors made of crystal, wooden lacquered structure polish black and painted metal base.
The disruptive design of the Rock sideboard is perfectly suited to rooms with contemporary aesthetics, thanks to the special single-pane glass work with nine relief bubbles on each door.

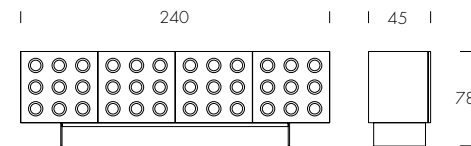
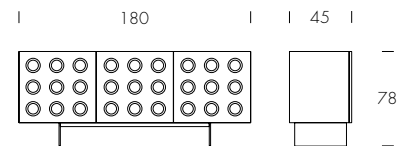



stripes

M. Mottin | E. Barbieri | 2023

Madia contenitore a tre o quattro ante in legno con finiture lineari e materiche, caratterizzate dalla lavorazione in altorilievo, in un gioco di contrasti dalle nuances bronzo. Stripes dona ad ogni ambiente un'estetica decisa, data dal suo design grafico.

Wooden sideboard with 3 or 4 doors with a textural finish, characterised by high relief work in a bronze shade play of contrasts. Stripes, with its graphic design gives any room a strong aesthetic.

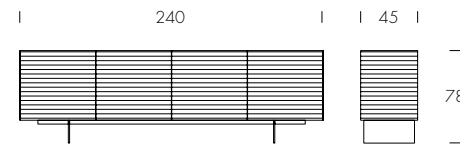
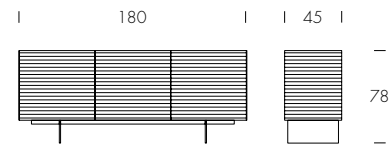



Stripes
struttura in stampa 3D a rilievo /
3D printed embossed structure.

ego

Tonin Casa Creatives | 2023

Elegante vetrina con base e top in legno, struttura e ripiani in cristallo extrachiaro trasparente.
Ego è un complemento d'arredo dallo stile raffinato, impreziosito dalla luce led interna che valorizza l'oggettistica contenuta.

An elegant display case with wooden base and top, structure, and shelves in transparent extra-clear glass. Ego is a piece of furniture with a refined style, embellished by the internal led light that enhances the contained objects.

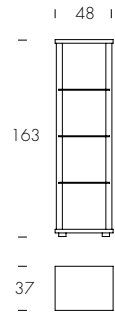

Ego
struttura bianco opaco / matt white structure (01).



ego round

Tonin Casa Creatives | 2023

Elegante vetrina dalla forma arrotondata, con base e top in legno, struttura e ripiani in cristallo extrachiaro trasparente.
Ego round è un complemento d'arredo dallo stile raffinato, impreziosito dalla luce led interna che valorizza l'oggettistica contenuta.

An elegant rounded shape display case with wooden base and top, structure, and shelves in transparent extra-clear glass. Ego round is a piece of furniture with a refined style, embellished by the internal led light that enhances the contained objects.

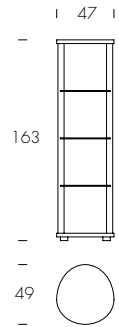

Ego Round
struttura rovere scuro /
dark oak structure (16).

ego plus

Tonin Casa Creatives | 2023

Elegante vetrina con base e top in legno, struttura e ripiani in cristallo extrachiaro trasparente.

Ego plus è un complemento d'arredo dallo stile raffinato, impreziosito dalla luce led interna che valorizza l'oggettistica contenuta.

An elegant display case with wooden base and top, structure, and shelves in transparent extra-clear glass. Ego plus is a piece of furniture with a refined style, embellished by the internal led light that enhances the contained objects.

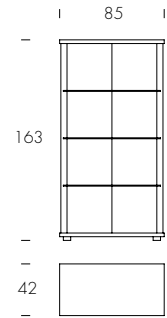

Ego Plus
struttura noce Canaletto / Canaletto walnut structure (14).

icon

Plurimo Design | 2023

La libreria Icon, firmata Plurimo Design, iconica nelle sue linee distintive, è ideale per organizzare con stile ogni ambiente living.
Il design dinamico di Icon rende versatile la sua funzione: la leggera struttura a stelo in legno massello, impreziosita da un filo di metallo in finitura oro, sostiene i ripiani in gres porcellanato, per comporre uno stile unico e ricercato.

Icon bookcase, designed by Plurimo Design, iconic in its distinctive lines, is ideal to organize every living space with style. The dynamic design of Icon makes its function versatile: the light stem structure in solid wood, embellished with a gold finish metal wire, supports the porcelain stoneware shelves, to compose a unique and refined style.

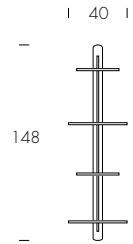

Icon
ripiani gres Portoro lucido /
glossy Portoro porcelain shelves (V85P);
struttura frassino nero /
black ash structure (25).

oasi

Luca Roccadadria | 2023

Libreria freestanding con sette ripiani di appoggio e finitura in grigio carbone, oro matt o bronzo pietra. L'elegante combinazione delle curve delicate dei piani di appoggio e il design modulare sono i tratti caratteristici di Oasi, raffinato elemento d'arredo dal design puro e contemporaneo.

Freestanding bookcase with seven shelves available in finish carbon grey, matt gold or bronze. The elegant combination of the delicate curves of the shelves and the modular design are the hallmarks of Oasi, a refined piece of furniture with a pure, contemporary design.

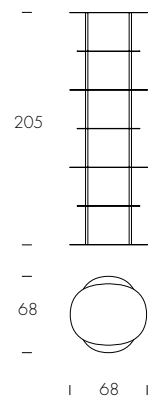

Oasi
struttura oro opaco /
matt gold structure (85).



Oasi
struttura grigio carbone /
carbon grey structure (10).



adone

M. Mottin | E. Barbieri | 2023

Ogni ambiente riluce di straordinaria bellezza con la consolle Adone, che unisce all'estetica scultorea le preziose finiture artigianali: Adone sorprende per l'audace abbinamento tra la naturalezza del top in varie finiture e la preziosità della base in vetro curvato bocciardato e retroargentato, nelle colorazioni bronzo o nero.

Every space shines with extraordinary beauty with the Adone console, which combines sculptural aesthetics with precious handcrafted finishes: Adone surprises with the audacious combination of the naturalness of the top in various finishes and the preciousness of the bush-hammered and retro-silvered curved glass base, in the bronze or black colors.

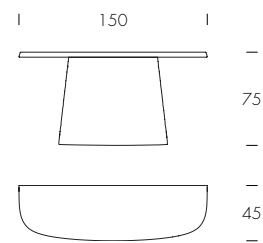

Adone
base vetro bocciardato bronzo /
bush-hammered bronze glass base (V83M);
top gres Statuario Altissimo /
Statuario Altissimo porcelain top (V01P).

tea

Angelo Tomaiuolo | 2023

Un piano di pura forma e materia compone la leggerezza della consolle Tea e dona alla sua struttura una levità quasi sospesa. L'elegante top in porcellana è incorniciato dal prezioso bordo in legno massello, in una combinazione che cattura lo sguardo e si distingue per l'eleganza del design.

A pure form and material make up the lightness of the Tea console and give its structure an almost suspended lightness. The elegant porcelain top is framed by the precious solid wood border, in a combination that catches the eye and stands out for the elegance of the design.

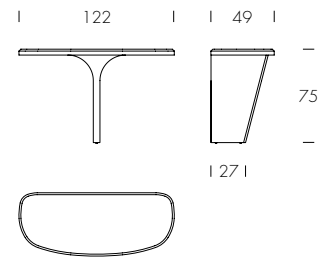

Tea
base noce Canaletto / Canaletto walnut base (14);
top gres Portoro lucido / glossy Portoro porcelain (V85P).

orologio anemos

Giuseppe Maurizio Scutellà | 2023

La lieve brezza dell'eleganza può soffiare in qualunque stanza con l'orologio specchiato Anemos, il cui nome allude al vento che sembra muovere l'elemento specchiante, un pezzo dal design intriso di fascino, un elemento d'arredo decorativo e funzionale che testimonia la continua ricerca di tecniche di lavorazione uniche e preziose.

The gentle breeze of elegance can blow through any room with the Anemos mirrored clock, whose name alludes to the wind that seems to move this charming piece of design. This decorative and functional piece of furniture bears witness to the ongoing quest for unique and precious manufacturing techniques.

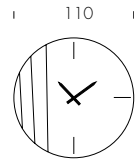

Orologio Anemos
struttura specchio bronzo / bronze mirror structure (V184).



decameron

Luca Roccadadria | 2023

Specchio scultoreo da parete a dieci lati: è Decameron, caratterizzato da due diverse finiture in vetro che si fondono l'una nell'altra, a creare un'onda che disegna una linea sinuosa. Un pezzo d'arredo che impreziosisce e amplia ogni tipo di ambiente.

Decameron is a sculptural wall mirror with ten sides characterised by two different glass finishes that merge into each other to create a wave of movement. A piece of furniture that enhances any type of environment.

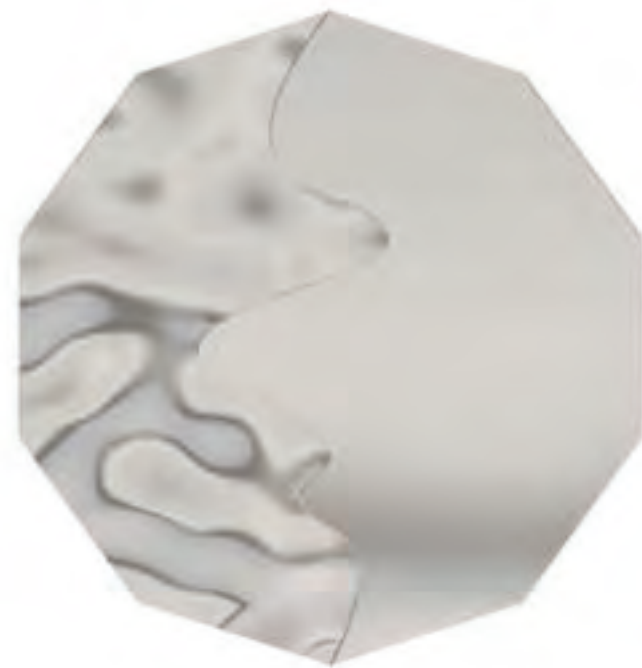
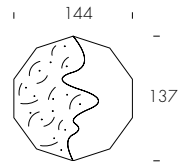

Decameron
struttura specchio bronzo / bronze mirror structure (V184).

diamante

Luca Roccadadria | 2023

Lo specchio da parete Diamante risplende in modo differente da ogni prospettiva, grazie alle rifrazioni date dalla particolare lavorazione del suo ovale, che unisce alla superficie liscia quella con la lavorazione in vetro cangiante, che dona un particolare effetto diamantato. Un pezzo di design prezioso e scultoreo che muta in base al punto di vista, creando un effetto di movimento unico.

The Diamante wall mirror shines in a different way from every angle thanks to the particular workmanship. His oval combines a smooth surface with an iridescent glass work creating a diamond effect. A precious and sculptural design piece that changes according to the point of view with a unique effect of movement.

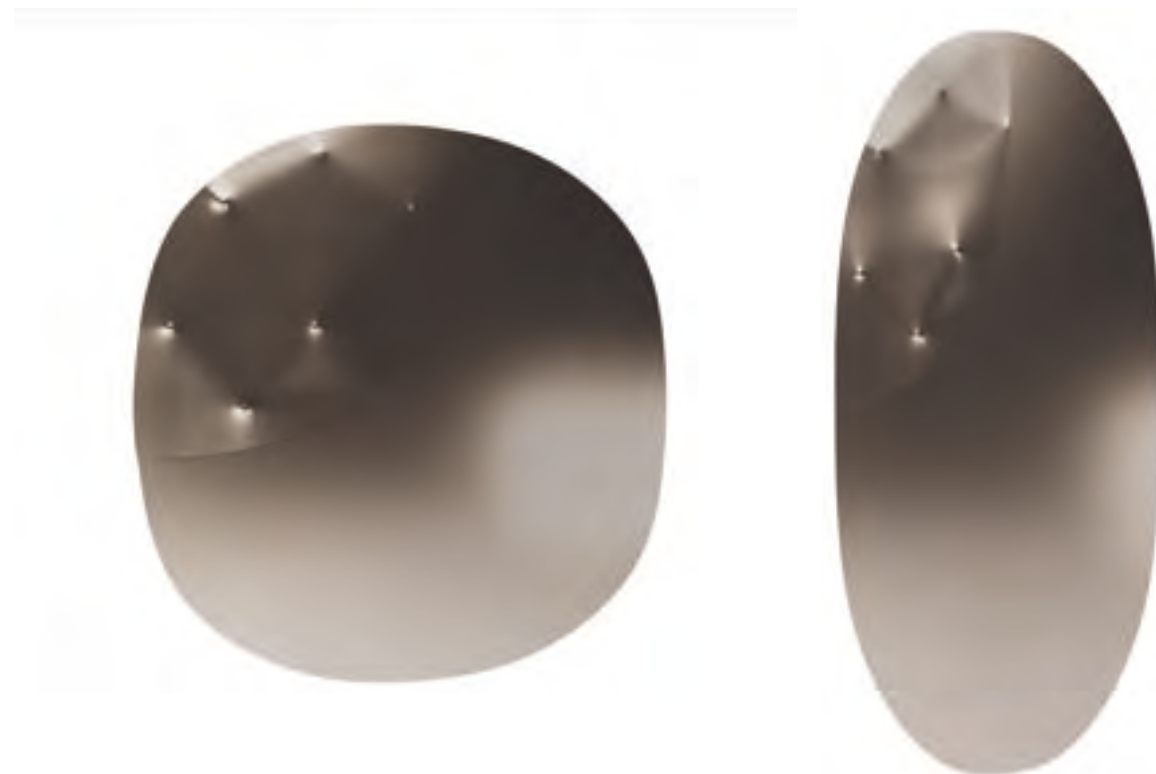
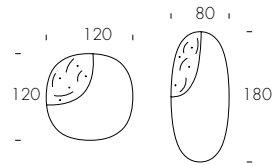

dorian

LM Design | E. Barbieri | 2023

Bellezza e piacere come suprema forma d'arte: lo specchio Dorian è un inno al romanzo di Oscar Wilde, "Il ritratto di Dorian Gray". Per celebrare quello che è diventato una sorta di manifesto della sua poetica, nasce questo specchio dall'estetica imponente, che diventa raffinato protagonista di design, con l'eleganza di Tonin Casa.

Lo specchio Dorian è caratterizzato da una sofisticata cornice dalla particolare lavorazione a corolla in vetro curvo argentato, con tonalità bronzo e fumè.

Beauty and pleasure as the supreme form of art: the Dorian mirror is an ode to Oscar Wilde's novel, "The Picture of Dorian Gray". To celebrate what has become a sort of manifesto of his poetics, this mirror with an imposing aesthetic is born, which becomes a refined design protagonist, with the elegance of Tonin Casa. The Dorian mirror is characterized by a sophisticated frame with a particular corolla processing in curved silver glass, with bronze and fumè shades.

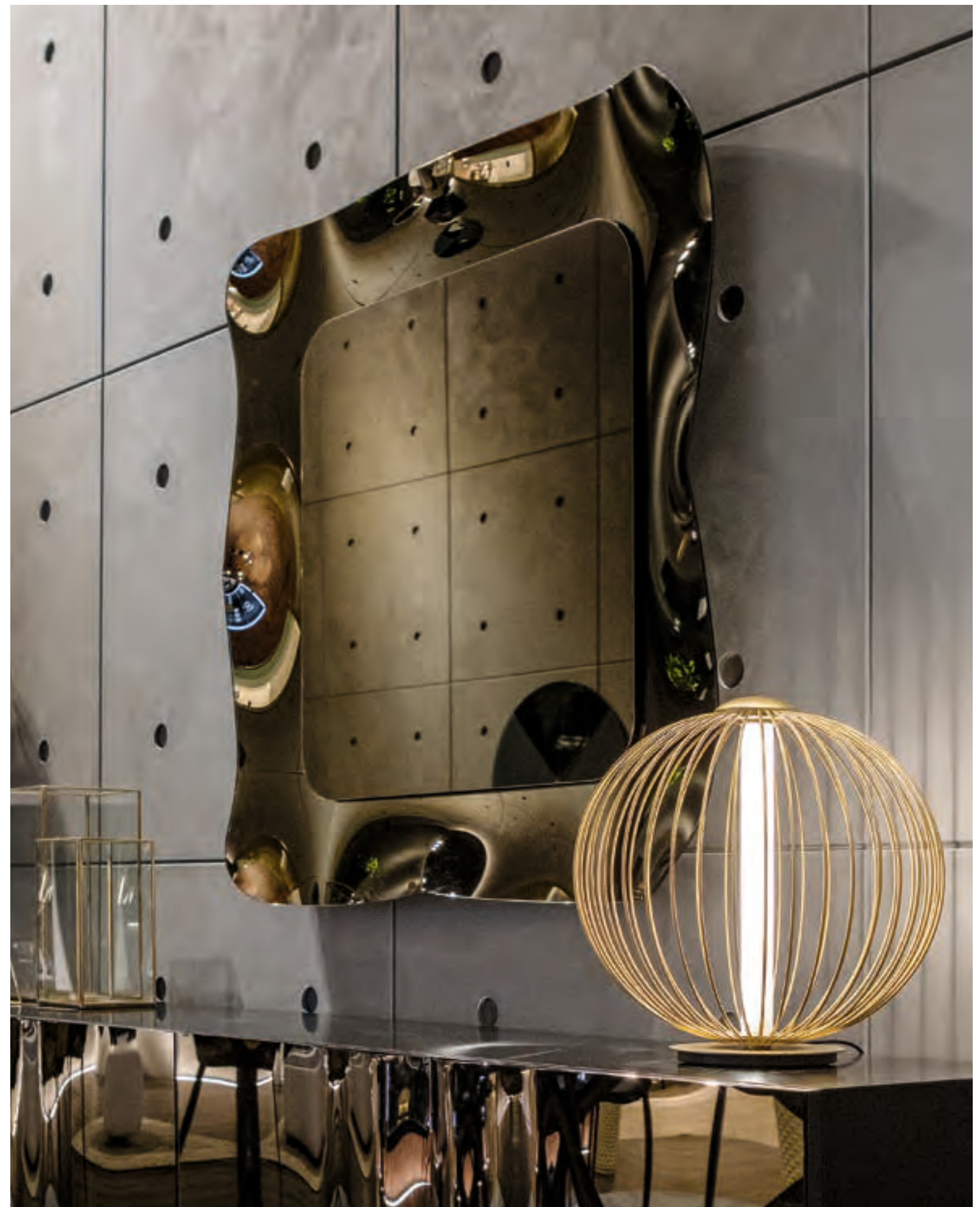
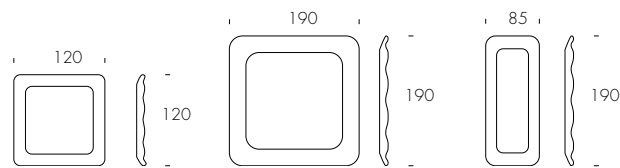

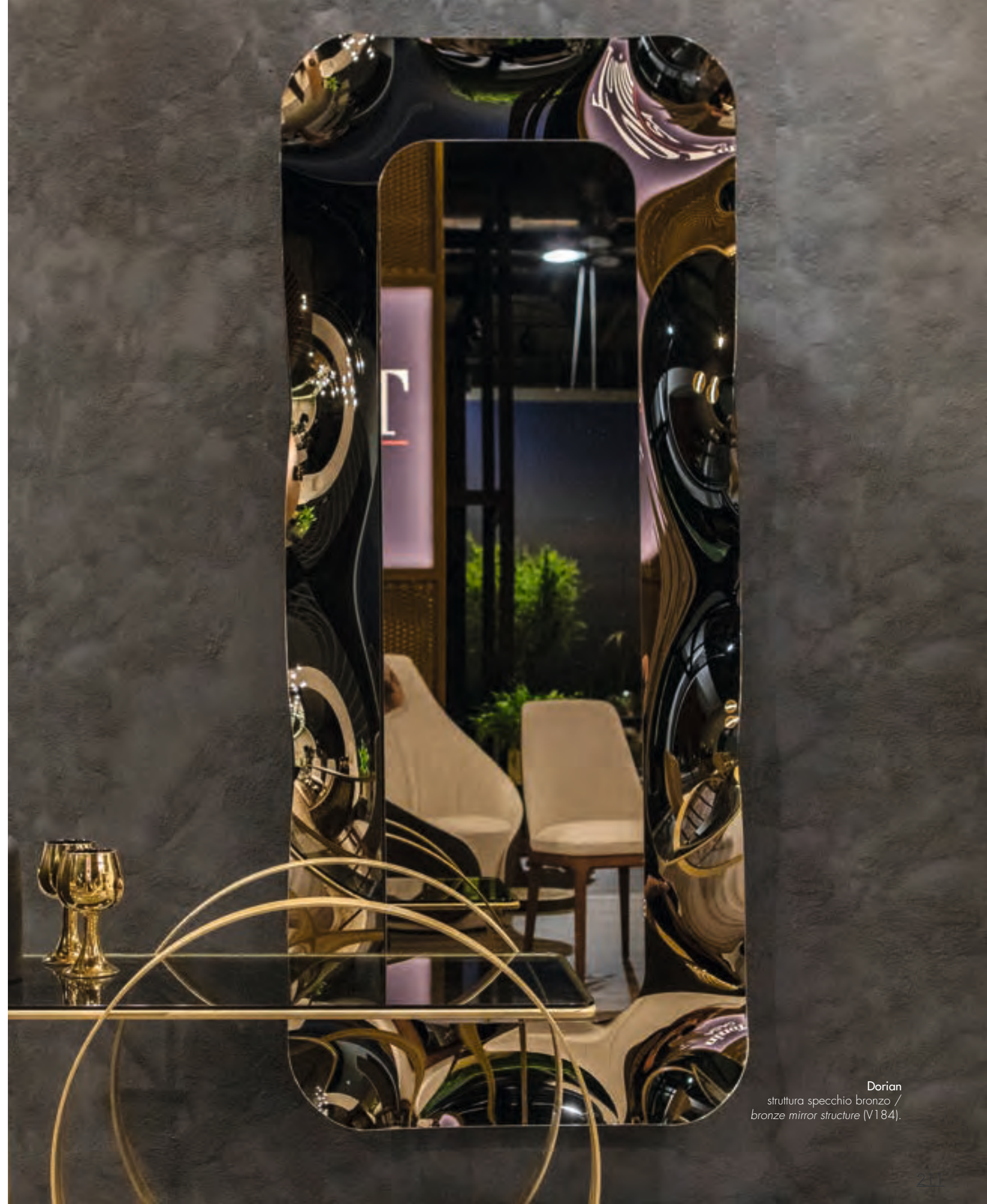

Dorian
struttura specchio bronzo /
bronze mirror structure (V184).

Dorian
struttura specchio fumè /
fumè mirror structure (VS87).

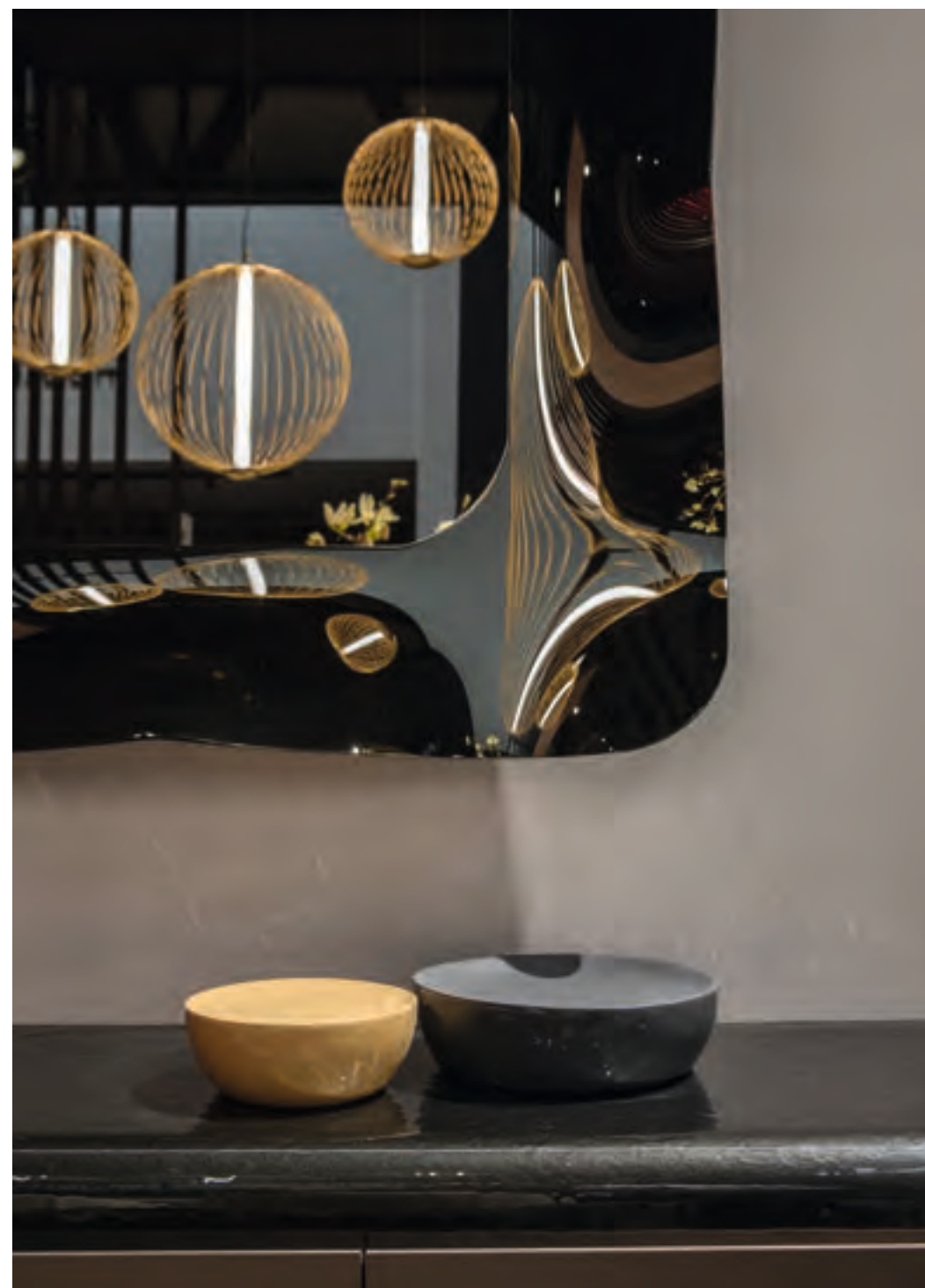

hive

Angelo Tomaiuolo | 2023

Angelo Tomaiuolo firma gli specchi Hive, dove la Musa ispiratrice è la natura: Hive richiama nel suo nome e nella sua forma le geometrie dell'alveare. La cornice esagonale è addolcita dalle sinuose simmetrie del legno massello, nelle finiture frassino nero e noce canaletto. Questo specchio evoca l'elemento naturale e lo integra in modo versatile in ogni spazio living. La superficie riflettente è disponibile nelle varie finiture fumè, bronzo o argento.

Angelo Tomaiuolo signs the Hive mirrors, where the inspiring Muse is nature: Hive recalls in its name and shape the geometries of the beehive. The hexagonal frame is softened by the sinuous symmetries of solid wood, in black ash and Canaletto walnut finishes. This mirror evokes the natural element and integrates it in a versatile way into every living space. The reflective surface is available in various fumè, bronze, or silver finishes.

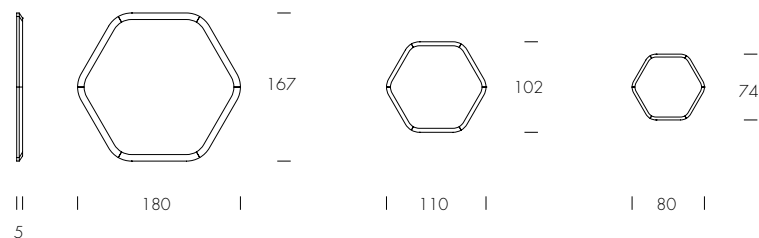

Hive
struttura frassino nero / black ash structure (25);
specchio fumè / fumè mirror (VS87);

struttura noce Canaletto / Canaletto walnut structure (14);
specchio bronzo / bronze mirror (V184).

kaleidos

E. Barbieri | M. Mottin | 2023

Trittico di specchi esagonali, con bisello in finitura argentata, bronzata o fumè. Le curvature delle forme geometriche che li caratterizzano rendono Kaleidos un complemento d'arredo versatile, dalle forme armoniche.

A triptych of hexagonal mirrors, with beveled edges in silver, bronze, or fumè finish. The curvatures of the geometric shapes that characterize them make Kaleidos a versatile furnishing complement, with harmonious forms.

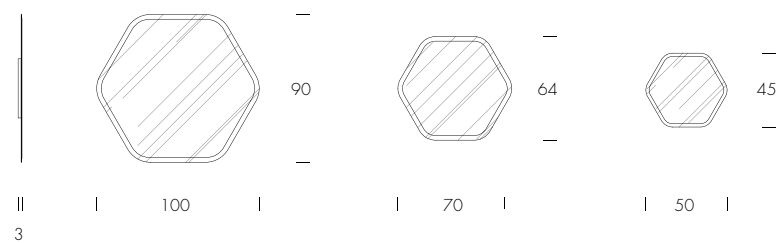

Kaleidos
struttura specchio fumè / fumè mirror structure (VS87).



moma

E. Barbieri | 2023

Specchio con cornice bombata in vetro curvo, con finiture bronzo e fumè. Con la sua estetica forte e audace, Moma si apre sulla parete come quadro splendente, donando uno stile moderno ad ogni ambiente.

Mirror with curved glass frame in bronze and fumè finish. With its strong and bold aesthetics, Moma mirror opens a shining picture on the wall, bringing a modern style to any room.

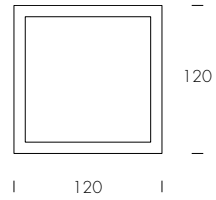

Moma
struttura specchio bronzo / bronze mirror structure (V184).

pitti

E. Barbieri | 2023

Specchio rettangolare con cornice in fusione goccia: con le sue delicate linee dai motivi geometrici, Pitti dona un fascino raffinato ad ogni tipo di spazio living.

Rectangular mirror with a droplet cast frame: with its delicate lines with geometric patterns, Pitti gives refined charm to any type of living space.

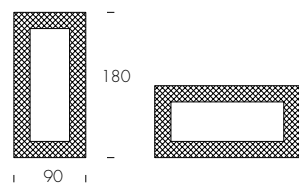

Pitti
struttura specchio bronzo / bronze mirror structure (V184).

rock

Luca Roccadadria | 2023

Il design dirompente dello specchio Rock si adatta perfettamente ad ambienti dall'estetica contemporanea, grazie alla particolare lavorazione in monolstra specchiata con nove bolle a rilievo.

The disruptive design of the Rock mirror is perfectly suited to rooms with contemporary aesthetics, thanks to the special mirrored single-piece frame with nine relief bubbles.

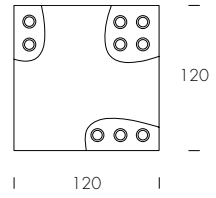

vinci

E. Barbieri | M. Mottin | 2023

Lo specchio rettangolare da parete Vinci è caratterizzato da un'elegante cornice con pattern tridimensionale, creato dalla lavorazione del legno, che ricorda la trama e l'ordito di un tessuto, con finitura laccato nero lucido.

The Vinci rectangular wall mirror is characterized by an elegant frame with a three-dimensional pattern, created by working wood, which recalls the warp and weft of a fabric, with a glossy black lacquered finish.

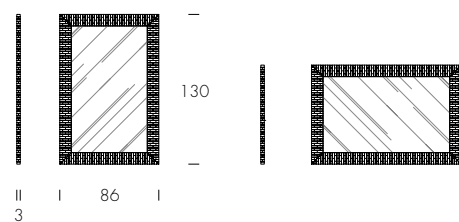

Vinci
struttura specchio argentato / silver mirror structure (V45).



arturo

Luca Roccadadria | 2023

Un pezzo di design creato interamente in vetro martellato: è Arturo, il tavolino che riflette nelle sue geometrie morbide la passione per l'artigianalità. La collezione di tavolini Arturo è disponibile in due misure, nell'elegante colorazione fumè.

A piece of design entirely created in hammered glass: that's Arturo, the coffee table that reflects the passion for craftsmanship in its soft geometries. The Arturo coffee table collection is available in two sizes, in an elegant fumè color.

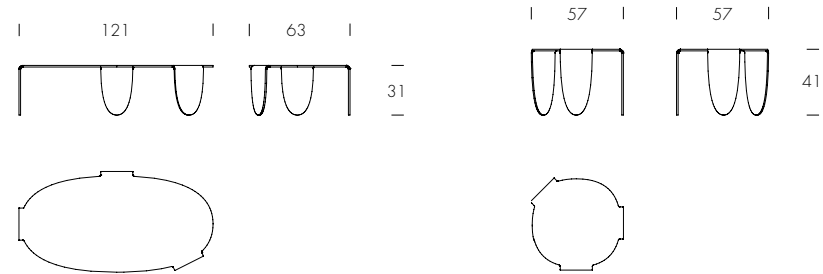



duals

Design OT + Partners | 2023

La struttura curva dei tavolini Duals definisce il loro design dalla sinuosa essenzialità formale: in metallo verniciato, versatili e funzionali sia come tavolini che comodini in camera da letto, sono caratterizzati da due pratici piani di appoggio rotondi, disponibili nella stessa finitura della struttura oppure nella versione con i top in gres porcellanato.

The curved structure of the Duals coffee tables defines their design with a sinuous formal essentiality: in painted metal, versatile and functional both as coffee tables and bedside tables in the bedroom, they are characterized by two practical round support surfaces, available in the same finish as the structure or in the version with porcelain stoneware tops.

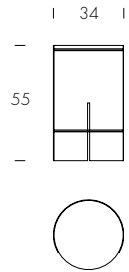

Duals
struttura grigio carbone / carbon grey structure (10);
top gres Statuario Altissimo / Statuario Altissimo porcelain tops (VO1P);
struttura bronzo pietra / stone bronze structure (83);
top gres Statuario Altissimo / Statuario Altissimo porcelain tops (VO1P).

dubai

Studio28 | Tonin Casa Creatives | 2023

Il design contemporaneo dell'iconico tavolino Dubai si arricchisce nella nuova variante con top in vetro fuso color fumè.

The contemporary design of the iconic Dubai coffee table is available in the new variant with cast fumè glass top.

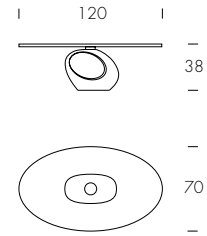

Dubai
struttura nero lucido / glossy black structure (502);
top vetro fumè fuso / cast fumè glass top (VF02).

magellano

Design OT + Partners | 2023

Il tratto caratteristico di Magellano è il suo design circolare e leggero che esalta i materiali che lo compongono: vetro fumè, vetro a specchio bronzo e acciaio verniciato della struttura e dei piedini.

Un tavolino elegante e versatile che valorizza ogni stile di interni.

The characteristic feature of Magellano is its circular and light design that enhances the materials that compose it: fumè glass, bronze mirror glass, and painted steel for the structure and legs. An elegant and versatile coffee table that enhances any interior style.

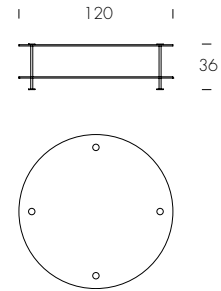

Magellano
top vetro trasparente fumè / transparent fumè glass top (V85);
base specchio bronzo / bronze mirror base (V184).



oasi

Luca Roccadadria | 2023

I tavolini Oasi fondono eleganza e funzionalità: raffinati elementi d'arredo dal design puro e contemporaneo, sono caratterizzati da due piani di appoggio dalle curve delicate, in finitura carbone, oro opaco o bronzo.

The Oasi coffee tables blend elegance and functionality: refined furnishing elements with a pure and contemporary design, characterized by two delicate curved support surfaces, available in a carbon grey, matt gold or bronze finish.

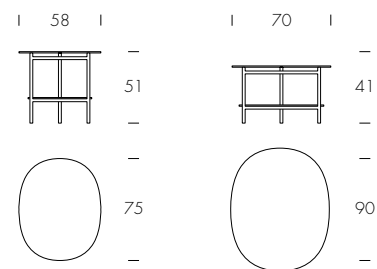

Oasi
struttura grigio carbone / carbon grey structure (10);
struttura titanio / titanium structure (34).

ocean

Tosca Design | 2023

Set di tre tavolini con base ad intreccio in metallo, con finitura oro opaco e top in vetro fuso color fumè.
L'estetica delle geometrie minimali della base contrasta con le leggere increspature del vetro fuso che evocano l'elemento naturale dell'acqua, regalando allo sguardo un gioco di contrasti unico e prezioso.

Set of three coffee tables with interlocking metal base in matt gold finish and fumè coloured fused glass top.
The minimal geometry of the base contrasts with the light ripples of the fused glass that evoke the natural element of water, creating a unique and precious contrast effect.

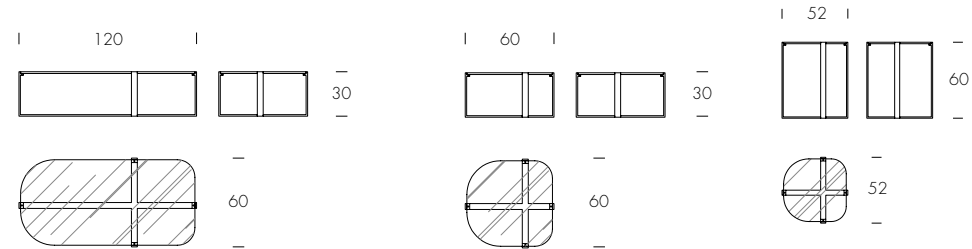



Ocean
struttura oro opaco /
matt gold structure (85);
top vetro fumè fuso /
fused fumè glass top (VF02).

ponti

Luca Roccadadria | 2023

La purezza formale caratterizza i tavolini Ponti, in vetro curvato dalla tonalità fumè. Il loro design lineare attribuisce allo spazio un'identità leggera.

Formal purity characterizes the Ponti coffee tables, in curved fumè glass. Their linear design gives the space a light identity.

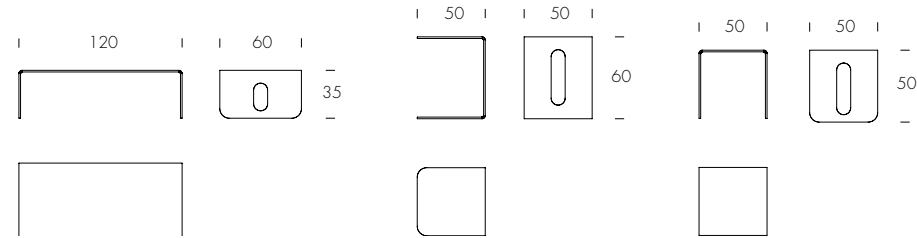

Ponti
struttura vetro fumè trasparente / transparent fumè glass structure (V85).

skyline

E. Barbieri | M. Mottin | 2023

Trittico di tavolini in metallo declinati in varie altezze, per offrire soluzioni versatili che sanno definire con eleganza lo spazio living. Le forme rettangolari e le linee essenziali che lo caratterizzano si adattano con funzionalità e stile a qualsiasi contesto. Skyline è disponibile nelle finiture grigio carbone, bronzo pietra, oro oppure con elegante top in porcellana.

A trio of metal coffee tables in various heights, to offer versatile solutions that elegantly define the living space. The rectangular shapes and essential lines that characterize it adapt with functionality and style to any context. Sky Line is available in carbon grey, bronze, gold, or with an elegant porcelain top.

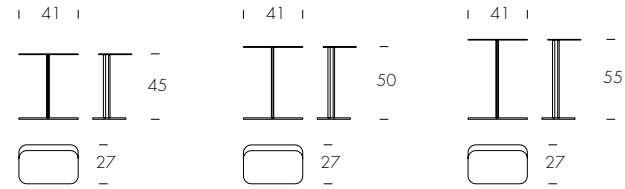

Skyline
struttura grigio carbone / carbon grey structure (10).



Skyline
struttura grigio carbone / carbon grey structure (10);
top gres Macchiavecchia opaco / matt Macchiavecchia porcelain top (V88P).

amphora

L. Roccadadria | E. Barbieri | 2023

Raffinate lampade a sospensione dal grande effetto scenico, che si possono posizionare a diverse altezze per creare composizioni dinamiche. Amphora, in cilindri di cristallo tonalità argento o fumè, è caratterizzata da una luce morbida e piena che regala un'atmosfera suggestiva.

Refined suspension lamps with a great scenic effect, which can be positioned at different heights to create dynamic compositions. Amphora, in silver or fumè crystal cylinders, is characterized a soft and full light that gives a suggestive atmosphere.

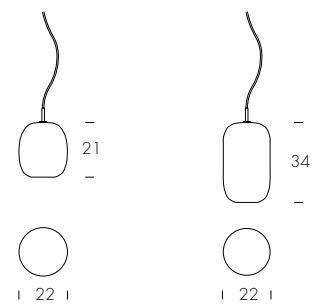

Amphora
struttura specchio argentato /
silver mirror structure (V4.5).



chic

L. Roccadadria | E. Barbieri | 2023

Eleganti lampade di design a sospensione, formate da sagome in cristallo trasparente dalle delicate geometrie e dettagli in finitura cromo nero lucido: la luce riverbera attraverso la superficie cannettata del vetro dalle tonalità ambra e fumè, creando una calda atmosfera. Le lampade Chic sono combinabili in molteplici composizioni e posizionabili a diverse altezze e distanze, per personalizzare ogni spazio living. Chic è disponibile anche in versione da tavolo, con base d'appoggio in metallo verniciato con finitura cromo nero lucido.

Elegant designer pendant lamps, formed by transparent crystal shapes with delicate geometries and details in glossy black chrome finish: the light reverberates through the ribbed surface of the glass in amber and fumè shades, creating a warm atmosphere. Chic lamps can be combined in multiple compositions and positioned at different heights and distances, to personalize any living space. Chic is also available in the table version, with a painted metal support base with glossy black chrome finish.

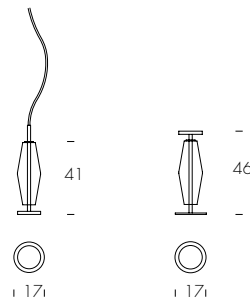

Chic
struttura vetro ambra /
amber glass structure (V55);
struttura vetro trasparente fumè /
transparent fumè glass structure (V85).



Chic
struttura vetro trasparente fumè /
transparent fumè glass structure (V85).

pagoda

L. Roccadadria | E. Barbieri | 2023

Come lanterne sospese, le lampade Pagoda si caratterizzano per le loro forme dolci e rotonde che tracciano un'illuminazione suggestiva e delicata. Posizionabili a diverse altezze e distanze, esaltano l'ambiente circostante con un armonioso effetto suggestivo. Pagoda è disponibile anche in versione da terra e tavolo, con base d'appoggio in metallo verniciato con finitura cromo nero lucido.

Like suspended lanterns, the Pagoda lamps are characterized by their sweet and round shapes which trace a suggestive and delicate lighting. Positionable at different heights and distances, they enhance the surrounding environment with a harmonious suggestive effect. Pagoda is also available in a floor and table version, with a painted metal support base with glossy black chrome finish.

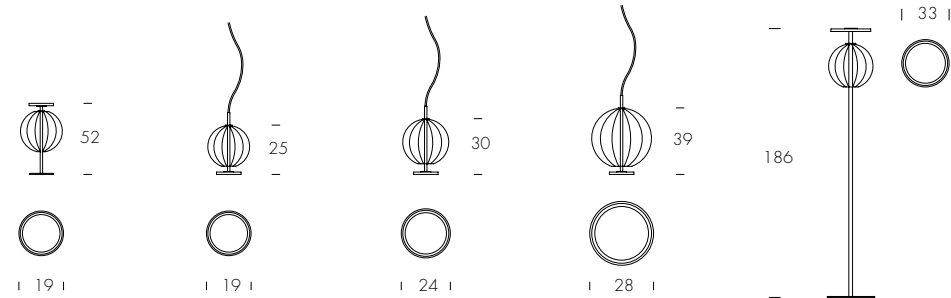

Pagoda
struttura vetro trasparente fumè /
transparent fumè glass structure (V85);
struttura vetro ambra /
amber glass structure (V55).



Pagoda
struttura vetro trasparente fumè /
transparent fumè glass structure (V85).



Pagoda
struttura vetro ambra / *amber glass structure (V55).*

all star night

Angelo Tomaiuolo | 2023

La Collezione All Star si completa con la linea notte All Star Night, composta da comodino contenitore con 2 cassetti, comò a 4 o 6 cassetti e la cassetiera verticale con 4 cassetti: l'essenzialità del loro design si fonde con la preziosa costellazione di petali in legno applicati a mano che ricoprono le basi dall'effetto specchiato.

The All Star Collection is completed with the All Star Night line, consisting of a bedside table with 2 drawers, a 4 or 6 drawer chest of drawers, and a vertical chest of drawers with 4 drawers: the essential design merges with the precious constellation of wooden petals applied by hand that cover the bases with a mirrored effect.

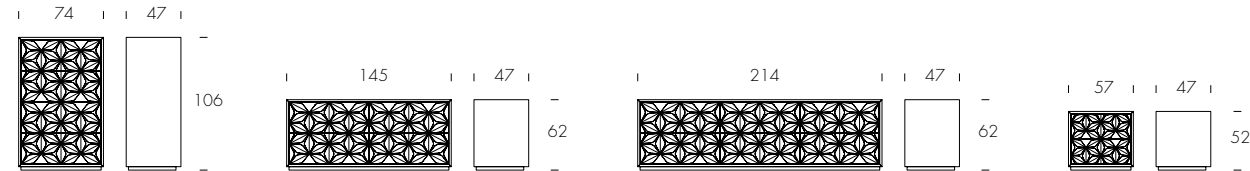

All Star night
struttura frassino nero / black ash structure (25);
specchio fumè / fumè mirror (VS87).

callisto

Angelo Tomaiuolo | 2023

Callisto è il servomuto in legno massello con base in marmo Port Saint Laurent, completo di specchio e parti in metallo con finitura oro. Un complemento d'arredo funzionale, dal design armonioso e raffinato.

Callisto is a solid wood valet stand with a Port Saint Laurent marble base, complete with a mirror and metal parts with a gold finish. A functional furnishing accessory, with a harmonious and refined design.

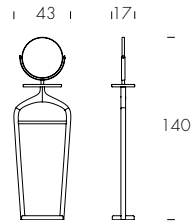

Callisto
struttura frassino nero /
black ash structure (25).

dan

Archirivolo | 2023

Il letto Dan accoglie con il suo design morbido, fatto di linee generose e forme arrotondate. La curvatura della testiera dalla caratteristica forma bombata lo rende sinuoso e accogliente. Dan caratterizza lo spazio notte con un'atmosfera avvolgente e raffinata, creando un'oasi di riposo invitante dall'eleganza assoluta. Dan è disponibile in varie finiture di tessuti esclusivi, velluti o pelli.

The Dan bed welcomes you with its soft design, made of generous lines and rounded shapes. The curvature of the headboard with its characteristic curved shape makes it sinuous and welcoming. Dan characterizes the bedroom with a cozy and refined atmosphere, creating an inviting oasis of absolute elegance. Dan is available in various finishes of exclusive fabrics, velvet or leather.

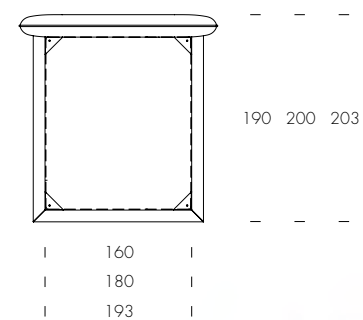
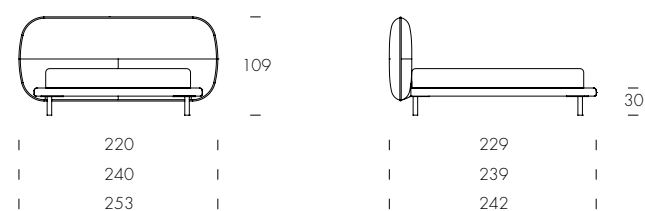



Dan
rivestimento tessuto Shade deserto /
desert Shade fabric covering (SH63).

ginger

M. Mottin | E. Barbieri | 2023

Ginger è la panca di design dall'effetto lineare e sofisticato. Realizzata con top in frassino nero lavorato a pattern dalle forme quadrate e base in metallo verniciato, è arricchita da due cuscinetti imbottiti rivestiti in pelle.

Ginger is the design bench with a linear and sophisticated effect. Made with a black wooden top worked in a pattern with square shapes and a painted metal base, it is enriched by two padded cushions covered in leather.

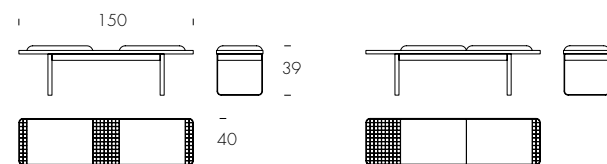

Ginger
struttura bronzo pietra / stone bronze structure;
top legno lavorato / wooden top;
seduta pelle nera / black leather seat.

essence

Tonin Casa Creatives | 2023

è un tappeto a lavorazione jacquard, in cotone e ciniglia, dall'effetto industrial chic e dalle tonalità materiche. Essence è disponibile in una gamma di dimensioni differenti, nel melange oro o argento.

Essence is a jacquard rug, in cotton and chenille, with an industrial chic effect and materials shades. Essence is available in a range of different sizes, in gold or silver.

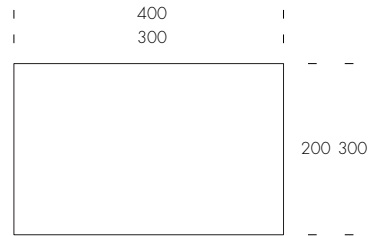

Essence
colore melange nero - argento / black - silver melange colour.



gea

Tonin Casa Creatives | 2023

Gea è un tappeto a lavorazione jacquard, in cotone e ciniglia, dalle calde tonalità che richiamano la terra. Gea è disponibile in una gamma di dimensioni differenti ed è realizzato sia nel formato rotondo che rettangolare.

Gea is a jacquard rug, in cotton and chenille, with warm shades that recall the earth. Gea is available in a range of different sizes and is made in both round and rectangular format.

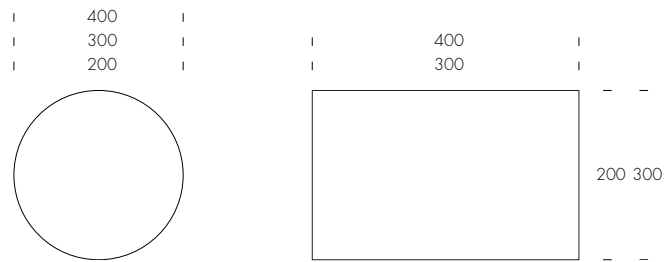

Gea
colore perla / pearl colour.

pixel

Tonin Casa Creatives | 2023

Tappeto a lavorazione jacquard, in cotone e ciniglia dalla particolare trama a effetto pixel, disponibile in una gamma di dimensioni differenti e nelle varianti colore grigio-blu e beige-verde.

Jacquard-woven rug in cotton and chenille with a particular pixel-effect texture, available in a range of different sizes and in grey-blue and beige-green colour variants.

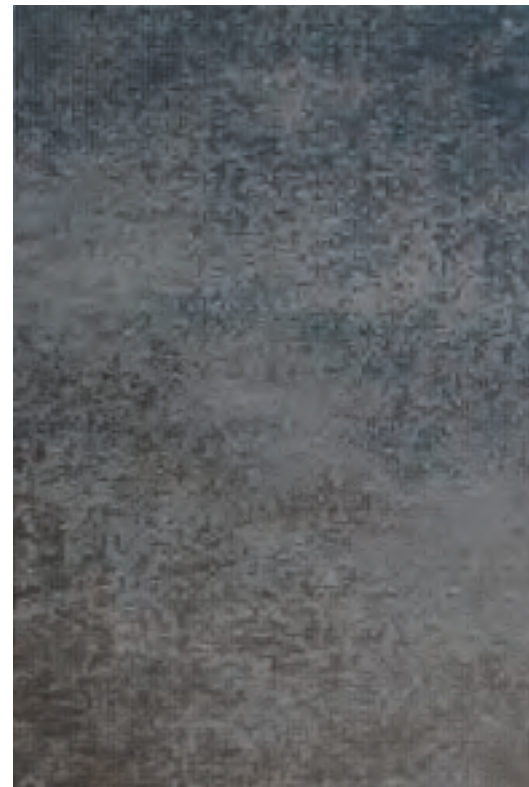
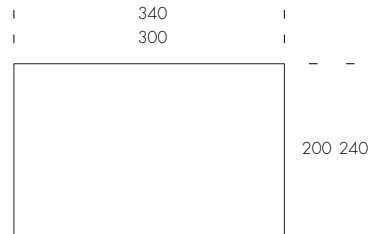

Pixel 2

vintage

Tonin Casa Creatives | 2023

Unione di eleganza e vintage caratterizzano questo tappeto a lavorazione jacquard, in cotone e ciniglia. L'effetto particolare del suo tessuto è dato dai tenui contrasti cromatici, dalle tonalità ecrù o dai contrasti più forti della variante grigia.

Union of elegance and vintage characterize this jacquard rug, in cotton and chenille. The particular effect of its fabric is given by the soft chromatic contrasts, by the ecru shades or the stronger contrasts of the grey variant.

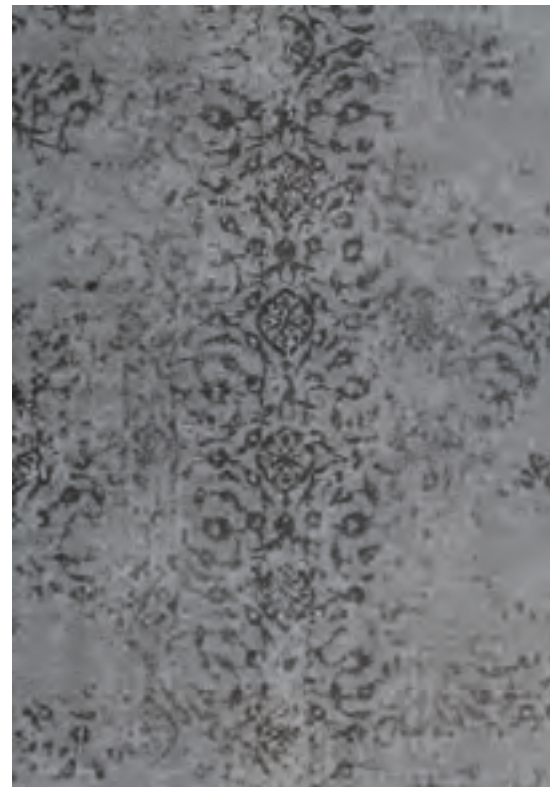
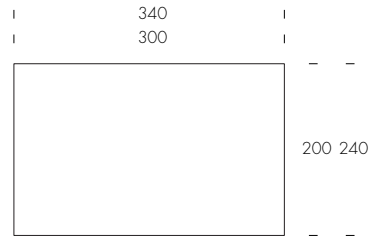

Vintage 1

botanika

Tonin Casa Creatives | 2023

I vasi in ceramica della Collezione Botanika si ispirano al mondo naturale dei fiori e richiamano nel loro design geometrico l'elemento della corolla. La linea si articola in quattro vasi, interamente realizzati a mano e proposti in soluzioni cromatiche diverse. I vasi Botanika diventano un naturale completamento del mondo Tonin Casa.

The ceramic vases of the Botanika Collection are inspired by the natural world of flowers and recall the element of the corolla in their geometric design. The line is divided into four vases, entirely handmade and offered in different chromatic solutions. Botanika vases become a natural completion of the Tonin Casa world.



chimera

Lato x Lato | 2023

Fantasticherie in ceramica artistica prendono vita nella nuova collezione Chimera: nascono così degli oggetti d'arredo fantasiosi e poliedrici che richiamano elementi umani e animali e dialogano con ogni spazio living, donando un tocco di eclettica unicità.

Queste giocose creature in ceramica artistica smaltata lucida con dettagli in legno massello e ottone sono disponibili con finiture bianco/nero e nero/oro zecchino.

Fantastic artistic ceramics come to life in the new Chimera collection: thus, fanciful and polyhedral furnishing objects are born, recalling human and animal elements and dialoguing with every living space, giving a touch of eclectic uniqueness. These playful creatures in shiny glazed artistic ceramic with details in solid wood and brass are available with black/white and black/gold finishes.



Chimera
colore nero lucido - oro zecchino /
glossy black - pure gold colour.

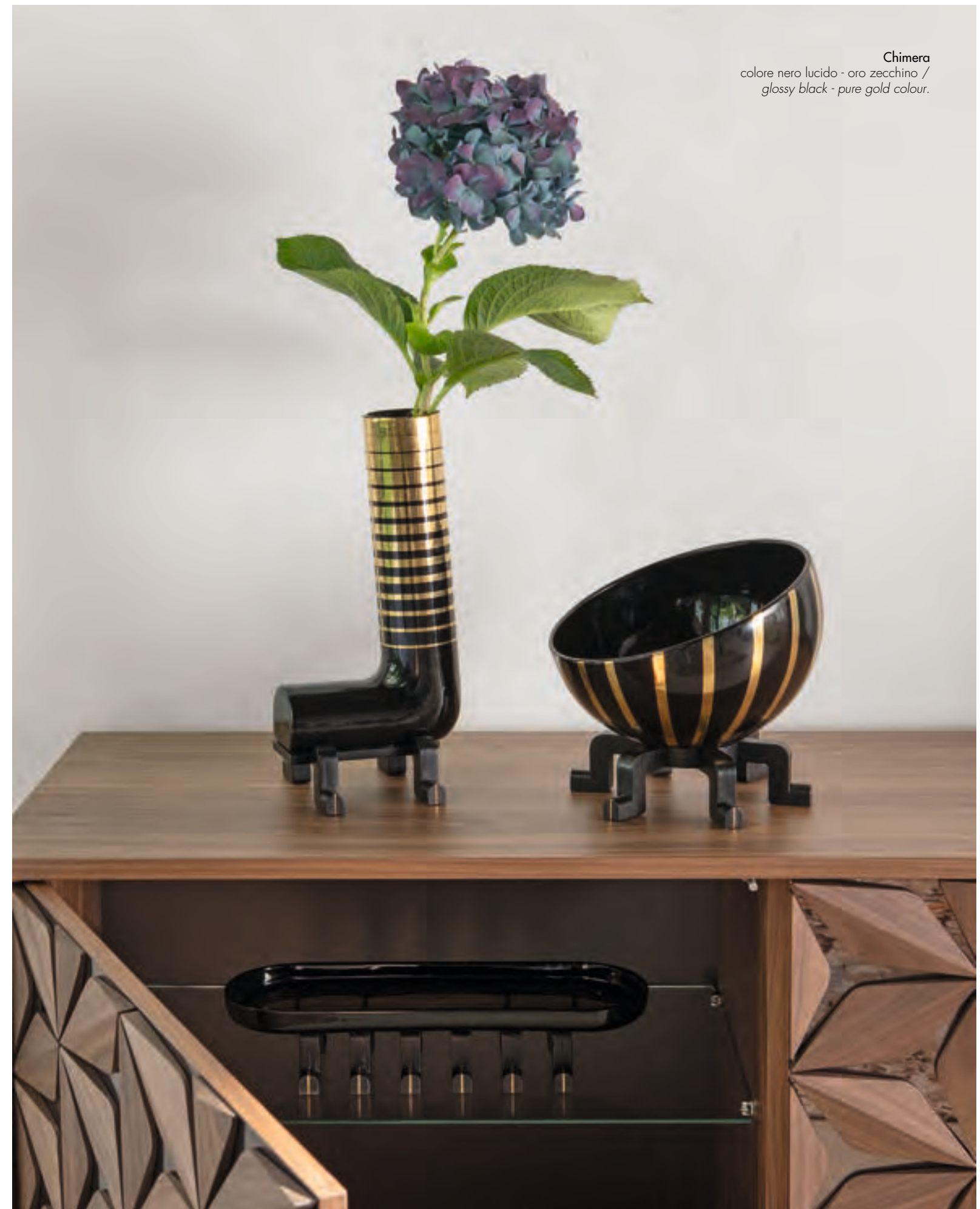

futurism

Lato x Lato | 2023

La Collezione Futurism di accessori per la casa prende ispirazione dalle linee geometriche e classiche delle antiche architetture italiane, traducendo le complesse sagome edilizie in elementi più essenziali. L'obiettivo di questa raccolta è proiettare il passato nel futuro, in un esercizio di eclettismo. Il metallo è il materiale scelto per questa traduzione, verniciato a polvere per mantenere l'aspetto liscio e testurizzato, tipico delle strutture in pietra. La Collezione Futurism, che si articola in un vaso, un centrotavola e un vassoio, è firmata da Lato x Lato.

The Futurism Collection of home accessories takes its inspiration from the geometric and classic lines of ancient Italian architecture, translating the complex building shapes into more essential elements. The goal of this collection is to project the past into the future, in an exercise in eclecticism. Metal is the material chosen for this translation, powder coated to maintain the smooth and textured look typical of stone structures. The Futurism Collection, which is divided into a vase, a centerpiece and a tray, is signed by Lato x Lato.



Futurism
colore grigio carbone - oro opaco /
carbon grey - matt gold colour.

pot

Tonin Casa Creatives | 2023

La Collezione di ciotole Pot, smaltate nelle colorazioni ocra, bianco perla e grigio, regala un tocco caldo e naturale allo spazio in cui si inseriscono. Questa Collezione di oggetti in ceramica crea un'armonia compositiva volta a esporre con eleganza gli oggetti della propria quotidianità.

The Pot Collection of bowls, glazed in ochre, pearl white and grey colours, gives a warm and natural touch to the space in which they are inserted. This Collection of ceramic objects creates a compositional harmony aimed at elegantly displaying the objects of one's everyday life.



Pot
colore ocra / ochre colour (02);
colore bianco perla / pearl white colour (01).

primitivi

Tonin Casa Creatives | 2023

Un materiale antico capace di sorprendere e l'amore per l'artigianalità: nasce la Collezione Primitivi, che esplora le tecniche artigianali per creare oggetti materici, caratterizzati da forme organiche dall'effetto grezzo. Ogni vaso è un pezzo unico, in vernice bianco perla, verde antico o grigio blu, proposto in tre forme diverse.

An ancient material capable of surprising and the love for craftsmanship: the Primitivi Collection is born, which explores artisan techniques to create material objects, characterized by organic shapes with a raw effect. Each vase is a unique piece, in pearl white, antique green or blue grey paint, available in different shapes.



wallpapers

Lato x Lato | 2023

Nuova Collezione di carte da parati firmata da Lato x Lato, per caricare di personalità l'abitare contemporaneo.

New collection of wallpapers designed by Lato x Lato, to add personality to contemporary living.



Cathedral Grey



Cathedral Multicolor

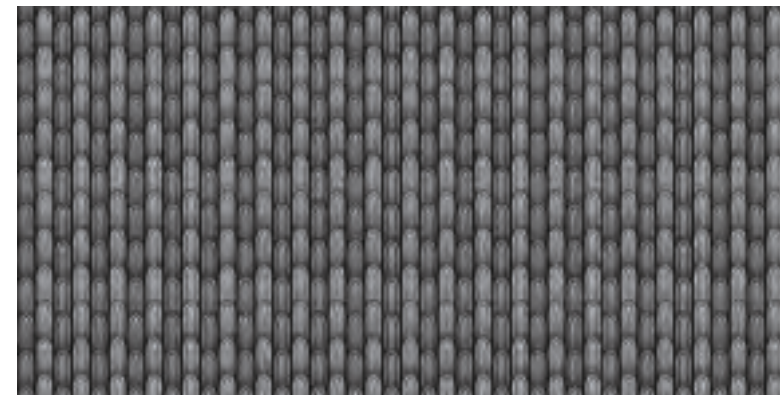

Sesto Acuto Black

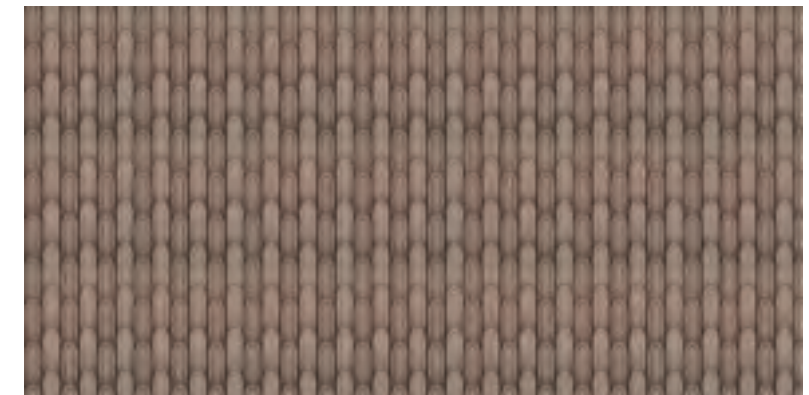

Sesto Acuto Brown

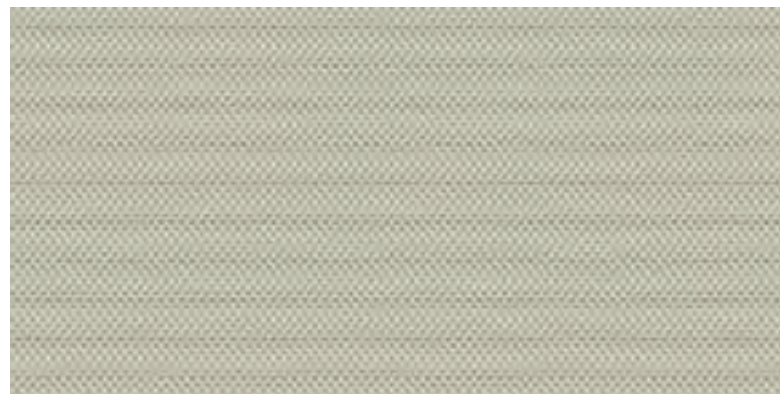

Helm Beige



Helm Turquoise



Tides Grey



Tides Ivory

gres porcellanato

porcelain stoneware



V_17P Alaska White



V_19P Tundra



ST02 Crystal Calacatta

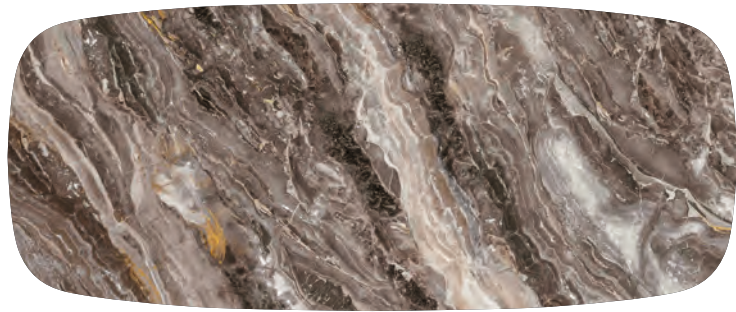

V_18P Orobico Chic

artistic glass

artistic glass

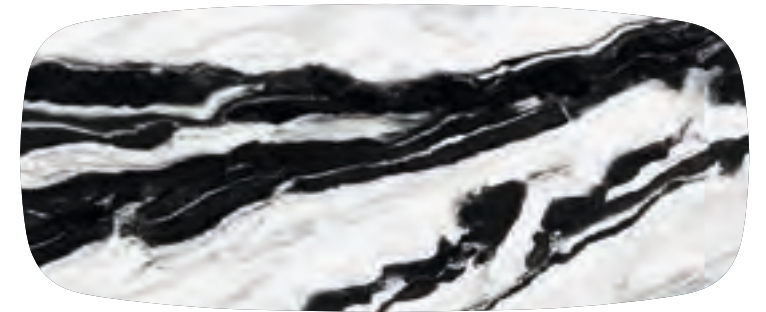

ST01 Galaxy black & white

orione couture

orione couture



IT

Tonin Casa si riserva di apportare, senza preavviso, modifiche nei materiali, nei rivestimenti, nelle finiture e nei disegni dei prodotti presentati in questo catalogo. Le texture e i colori dei materiali e delle finiture hanno valore indicativo in quanto soggetti alle tolleranze dei processi di stampa.

È vietata ogni riproduzione totale e parziale in Italia e all'estero.

ES

Tonin Casa se reserva el derecho de aportar modificaciones de dibujo, materiales, acabados y tapicerías, sin que esté obligada a dar aviso anticipado. Las texturas y los colores de los materiales y de los acabados tienen solo un valor indicativo porque están sujetos a la tolerancia en los procesos de imprenta.

Prohibida la reproducción total o parcial en Italia y en el extranjero.

EN

Tonin Casa reserves the right to change, without previous notice, materials, covers, finishes and drawings of the products presented in this catalogue. The textures and colours of materials and finishes are indicative as they are depending on the tolerances of the printing process.

Total or partial reproduction of the products is prohibited in Italy and abroad.

FR

Tonin Casa se réserve le droit d'apporter, sans préavis, des modifications au niveau des matériaux, des revêtements, des finitions et du design des produits présentés dans ce catalogue. Les textures et les couleurs des matériaux et des finitions sont une valeur indicative parce-que ils changent selon la tolérance aux procédés d'imprimerie.

La reproduction, totale ou partielle, est interdite, que ce soit en Italie ou à l'étranger.

RU

Tonin Casa оставляет за собой право, без каких-либо предупреждений, вносить изменения в используемые материалы, обивки, отделки и изображения продукции, представленной в данном каталоге.

Текстура и цвета материалов и отделок имеют ориентировочный характер, так как могут варьироваться в процессе печати.

progetto
design

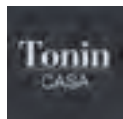

Tonin Casa is a brand of
Progetto Design International srl

via Guglielmo Marconi, 37
35010 San Pietro in Gu (PD), Italy

t +39 049 9453300
f +39 049 9450725

info@tonincasa.it
c.f. P.iva IT03817150240

COPYRIGHT © Progetto Design International srl
Tutti i diritti riservati - All rights reserved

Stampa / Print:

Grafiche Antiga

Stampato in Italia Settembre 2023 / Printed in Italy September 2023



Tonin
CASA